

This Owner's Manual is provided and hosted by [Appliance Factory Parts](#).

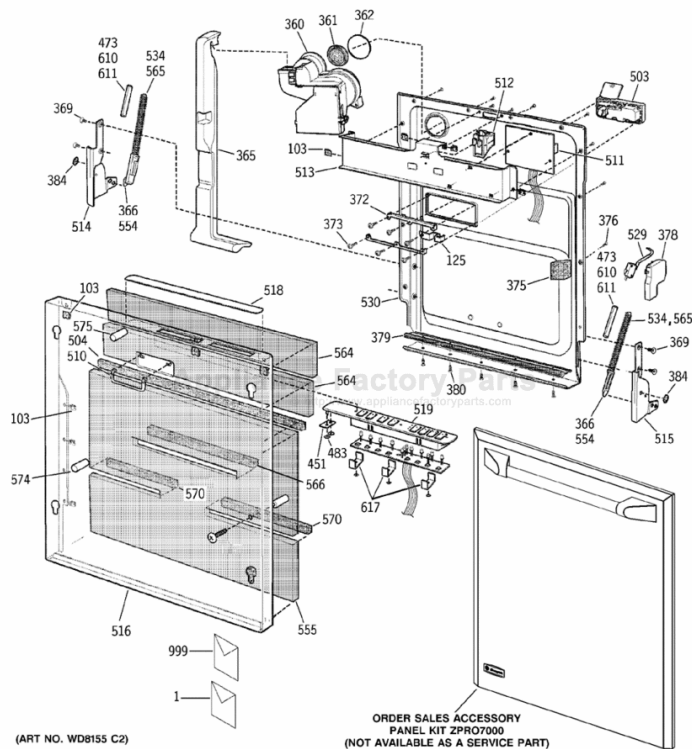

GE ZBD7000G04II Owner's Manual

[Shop genuine replacement parts for GE ZBD7000G04II](#)



[Find Your GE Dishwasher Parts - Select From 6722 Models](#)

----- Manual continues below -----

Installation Instructions

ZPRO7000S Professional Style Stainless Steel Door Panel Kit For ZBD7000GII and ZBD7005GII

- 1 Lay the dishwasher on its back.
- 2 Secure the panel to the door by inserting the top and bottom shoulder washers into the matching keyhole slots. Make sure all 4 washers engage the keyhole slots.

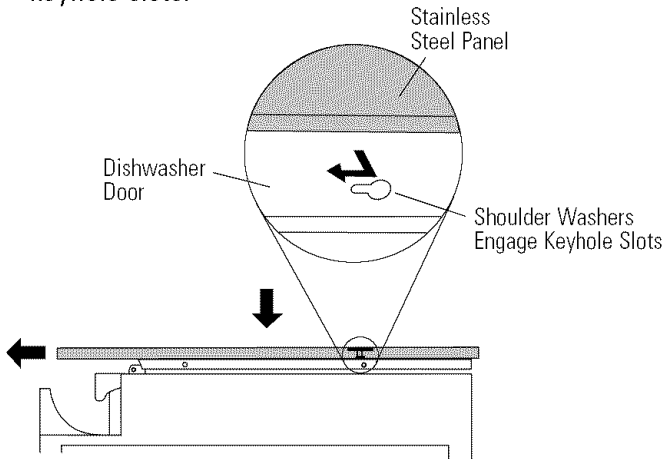

- 3 Press the panel against the door and push downwards until the washers are fully engaged into the keyhole slots. The panel should align evenly with the top and sides.

- 4 Stand the dishwasher upright.

- 5 Open dishwasher door and drive the supplied #6 x 2 Phillips screws through the inner door and into the panel. Drive one screw at the top and then one screw on each side as shown.

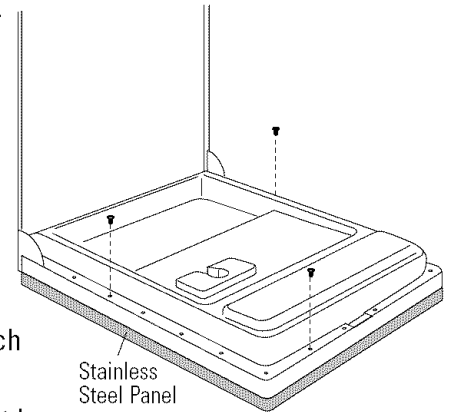

- 6 Door springs must be installed in the correct position.

Position	Left Side	Right Side
Front	N/A	Blue
Rear	Green	Green

See Spring Removal instructions below.

TO REMOVE THE SPRING AND SPRING SUPPORT ROD

- 1 Close the door and lift the bottom of the support rod upward and away from the slot in the door hinge.
- 2 Pull the rod downward from the guide in the side plate.
- 3 Remove the spring and spring sleeve from the rod.
- 4 Reassemble in reverse order.

NOTES:

- The front spring sleeves and support rods are different from the rear ones. When comparing the two support rods, the front rods have two extra 5/32" diameter round lugs approximately 1/3 of the way along the rod; the rear rods do not have these lugs. The external spring sleeve for the front spring assembly is the longer of the two. If the front rod and front sleeve are installed in the rear position, the door will not open all the way and the rod is likely to come off when the door is closed. Make sure the correct assemblies are reinstalled in the correct positions.

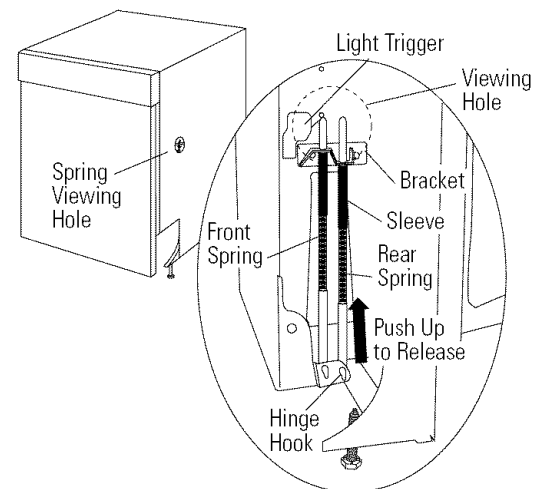

- Take care not to damage the interior light trigger operated by the right hand front support rod.
- A spring and support rod must always be present in the right hand front position to activate the light trigger.

Pub. No. 31-30573

Part No. 206C1559P113

03-04 JR

Printed in the United States