

This Owner's Manual is provided and hosted by [Appliance Factory Parts](#).



GE ZBD0700K10II Owner's Manual

[Shop genuine replacement parts for GE ZBD0700K10II](#)



[Find Your GE Dishwasher Parts - Select From 6722 Models](#)

----- Manual continues below -----

Owner's Manual

Dishwasher

ZBD6800

ZBD6880

ZBD6890

ZBD0700

ZBD0710



Introduction

Your new Monogram dishwasher makes an eloquent statement of style, convenience and kitchen planning flexibility. Whether you chose it for its purity of design, practical features or assiduous attention to detail—or for all of these reasons—you'll find that your Monogram dishwasher's superior blend of form and function will delight you for years to come.

The information on the following pages will help you operate and maintain your dishwasher properly.

If you have any other questions, visit our Website at: www.monogram.com

Contents

Appliance Registration	3, 23, 24	Problem Solver	16–19
Care and Cleaning	15	Safety Instructions	4, 5
Consumer Services	3, 20	U.S.A. Warranty	21
Model and Serial Number Location	3	Canada Warranty	22
Operating Instructions	6–14		
Control Panel and Operation	6–8		
Lighting Features	9		
Water Temperature	9		
Rinse Agent	9		
Dish Preparation Prior to Loading	10		
Detergents	10		
Dishwasher Racks	11–14		

Before using your dishwasher

Read this manual carefully. It is intended to help you operate and maintain your new dishwasher properly.

Keep it handy for answers to your questions.

If you don't understand something or need more help, there is a list of toll-free consumer service numbers included on the Consumer Services page in the back section of this manual.

OR

Visit our Website at: www.monogram.com

Write down the model & serial numbers

You can locate your model and serial numbers on the tub wall just inside the door.

Before sending in the card, please write these numbers here:

Model Number

Serial Number

Use these numbers in any correspondence or service calls concerning your dishwasher.

If you received a damaged dishwasher

Immediately contact the dealer (or builder) that sold you the dishwasher.

Save time & money

Before you request service, check the Problem Solver in the back of this manual.

It lists causes of minor operating problems that you can correct yourself.

If you need service

To obtain service, see the Consumer Services page in the back of this manual.

We're proud of our service and want you to be pleased. If for some reason you are not happy with the service you receive, here are steps to follow for further help.

For customers in the USA:

FIRST, contact the people who serviced your appliance. Explain why you are not pleased. In most cases, this will solve the problem.

NEXT, if you are still not pleased, contact us on our website, write all the details—including your phone number—or write to:

Manager, Customer Relations
GE Appliances
Appliance Park
Louisville, KY 40225

For customers in Canada:

FIRST, contact the people who serviced your appliance. Explain why you are not pleased. In most cases, this will solve the problem.

NEXT, if you are still not pleased, write all the details—including your phone number—to:

Manager, Consumer Relations
Camco Inc.
1 Factory Lane, Suite 310
Moncton, N.B. E1C 9M3

IMPORTANT SAFETY INSTRUCTIONS

▲ **WARNING!**

For your safety, the information in this manual must be followed to minimize the risk of fire, explosion, electric shock, or to prevent property damage, personal injury, or loss of life.

- Do not tamper with controls.
- Do not abuse, sit on, or stand on the door or dish rack of the dishwasher.
- Do not discard a dishwasher without first removing the door or removing the door latch.

- Do not store or use combustible materials, gasoline or other flammable vapors and liquids in the vicinity of this or any other appliance.
- Do not allow children to play inside, on or with this appliance or any discarded appliance.
- Do not allow children to play around the dishwasher when opening and closing the door due to possibility of small fingers being pinched in the door.

▲ **WARNING! RISK OF CHILD ENTRAPMENT**

PROPER DISPOSAL OF THE DISHWASHER

Junked or abandoned dishwashers are dangerous...even if they will sit for "just a few days." If you are getting rid of your old dishwasher, please follow the instructions below to help prevent accidents.

Before You Throw Away Your Old Dishwasher:

- Take off the door of the washing compartment or remove the door latch keeper (as shown).

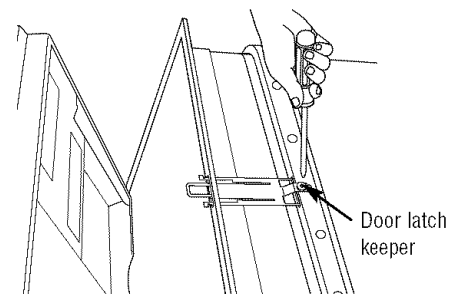

▲ **WATER HEATER SAFETY**

Under certain conditions hydrogen gas may be produced in a water heater that has not been used for two weeks or more. **HYDROGEN GAS IS EXPLOSIVE.**

If the hot water has not been used for two weeks or more, prevent the possibility of damage or injury by turning on all hot water faucets and allowing them to run for several minutes. Do this before using any electrical appliance which is connected to the hot water system. This simple procedure will allow any built-up hydrogen gas to escape. Since the gas is flammable, do not smoke or use an open flame or appliance during this process.

IMPORTANT SAFETY INSTRUCTIONS

PROPER INSTALLATION AND MAINTENANCE

This dishwasher must be properly installed and located in accordance with the Installation Instructions before it is used. If you did not receive an Installation Instructions sheet with your dishwasher, you can receive one by visiting our Website at www.monogram.com.

- Connect to a grounded metal, permanent wiring system; or run an equipment-grounding conductor with the circuit conductors and connect to the equipment-grounding terminal or lead of the appliance.
- Improper connection of the equipment-grounding conductor can result in a risk of electric shock. Check with a qualified electrician or service representative if you are in doubt whether the appliance is properly grounded.
- Use supply conductors rated at least 75° C (167° F).

- Dispose of discarded appliances and shipping or packing material properly.
- Do not attempt to repair or replace any part of your dishwasher unless it is specifically recommended in this manual. All other servicing should be referred to a qualified technician.
- To minimize the possibility of electric shock, disconnect this appliance from the power supply before attempting any maintenance. **NOTE:** Turning the dishwasher off does not disconnect the appliance from the power supply. We recommend having a qualified technician service your appliance.

WHEN USING YOUR DISHWASHER

Use this appliance only for its intended purpose as described in this Owner's Manual.

▲ CAUTION: Contents washed in Anti-Bacterial cycle may be hot to the touch. Use care before unloading.

- Use only powder, tabs or liquid detergents or wetting agents recommended for use in a dishwasher and keep them out of the reach of children. **Cascade®**, **Cascade Complete®** and **Electrasol®** Automatic Dishwashing Detergents and **Jet-Dry®** and **Cascade Rinse Aid®** rinse agents have been approved for use in all Monogram Dishwashers.

- Using a detergent that is not specifically designed for dishwashers will cause the dishwasher to fill with suds.

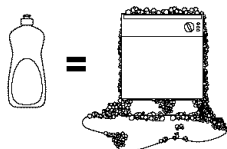

- If your dishwasher is connected to a wall switch, insure that the switch is on prior to use.
- If you choose to turn the switch off between wash cycles, allow 5–10 seconds after turning the switch on before pressing the START/RESET pad to allow the control to boot.

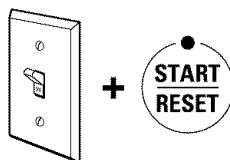

- Locate sharp items so that they are not likely to damage the door seal.
- Load sharp knives with the handles up to reduce the risk of cut-type injuries.
- Do not wash plastic items unless marked *dishwasher safe* or the equivalent. For plastic items not so marked, check the manufacturer's recommendations.
- Non-Dishware Items: Do not wash items such as electronic air cleaner filters, furnace filters and paint brushes in your dishwasher. Damage to dishwasher and discoloration or staining of dishwasher may result.
- Do not touch the heating element during or immediately after use.
- Do not operate your dishwasher unless all enclosure panels are properly in place.
- Close supervision is necessary if this appliance is used by or near children.
- Load light plastic items so they will not become dislodged and drop to the bottom of the dishwasher—they might come into contact with the heating element and be damaged.

**READ AND FOLLOW THIS SAFETY INFORMATION CAREFULLY.
SAVE THESE INSTRUCTIONS**

Control Panel

Dishwasher

You can locate your model number on the tub wall just inside the door. Throughout this manual, features and appearance may vary from your model.

ZBD6800 and ZBD6880

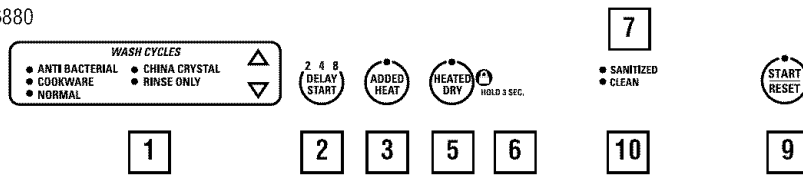

ZBD0710

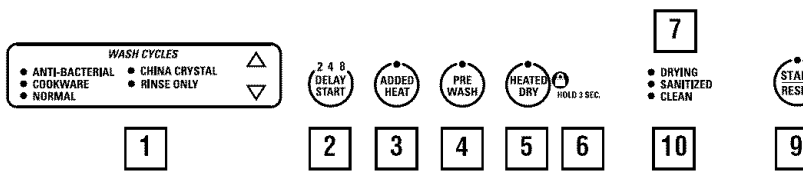

ZBD6890 and ZBD0700

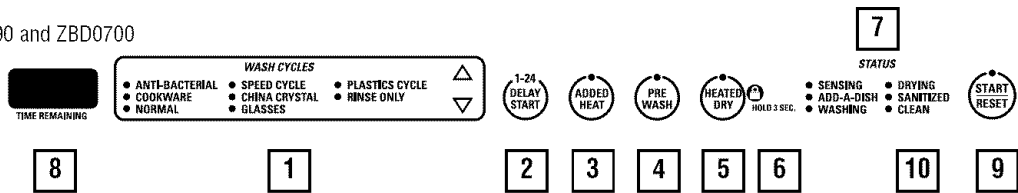

Control Settings

1 Wash Cycles

Use the arrow pads Δ ∇ to scroll through the wash cycles. The light above or next to the selected pad will be ON to indicate which WASH CYCLE has been selected.

NOTE: This dishwasher is equipped with an ExtraClean™ Sensor with automatic temperature control; therefore, cycle time and total water consumption may vary depending on soil (heavy, medium, light) and temperature conditions.

ANTI BACTERIAL

Heavy 9.1 gallons, 92 minutes
Medium 7.8 gallons, 89 minutes
Light 6.5 gallons, 87 minutes

This cycle raises the water temperature in the final rinse to sanitize your dishware. The cycle length will vary depending on the temperature of your inlet water.

NOTE: The Anti-Bacterial cycle is monitored for sanitization requirements. If the cycle is interrupted during or after the main wash portion or if the incoming water temperature is so low that adequate water heating cannot be achieved, the sanitizing conditions may not be met. In these cases, the sanitized light will not illuminate at the end of the cycle.

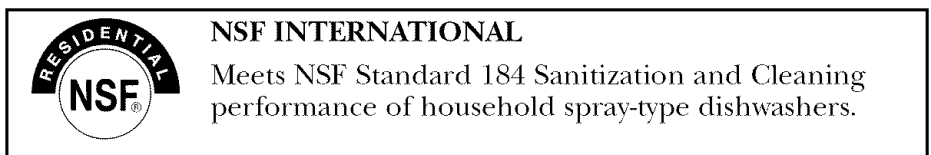

NOTE: NSF certified residential dishwashers are not intended for licensed food establishments.

COOKWARE

Heavy 10.4 gallons, 102 minutes
Medium 9.1 gallons, 77 minutes
Light 7.8 gallons, 72 minutes

This cycle is meant for heavily soiled dishes or cookware with dried-on or baked-on soils. This cycle may not remove burned-on foods. Everyday dishes are safe to be used in this cycle.

NORMAL

Heavy 9.1 gallons, 78 minutes
Medium 6.5 gallons, 62 minutes
Light 5.2 gallons, 49 minutes

This cycle is for medium/heavily soiled dishes and glassware.

SPEED CYCLE (on some models)

Heavy 7.8 gallons, 37 minutes
Medium 6.5 gallons, 33 minutes
Light 5.2 gallons, 29 minutes

This cycle is for everyday dishes and glassware.

CHINA Heavy 9.1 gallons, 53 minutes
CRYSTAL Medium 7.8 gallons, 45 minutes
 Light 6.5 gallons, 38 minutes

This cycle is for lightly soiled china and crystal.

GLASSES Heavy 9.1 gal., 50 min.
 (on some models) Medium 7.8 gal., 42 min.
 Light 6.5 gal., 40 min.

This cycle is specifically designed for glasses.

PLASTICS Heavy 9.1 gal., 123 min.
CYCLE Medium 7.8 gal., 114 min.
 (on some models) Light 6.5 gal., 107 min.

This cycle is specifically designed to reduce the risk of melting plastic items and improve plastic drying for dishwasher safe plastic items.

RINSE ONLY Heavy 2.6 gallons, 7 minutes
 Light 1.3 gallons, 4 minutes

For rinsing partial loads that will be washed later. Do not use detergent with this cycle.

2 DELAY START—This option will allow you to delay the start time of any wash cycle for up to 8 or 24 hours (depending on model).

- Select the delay start time you want by pressing the DELAY START pad. Multiple or continuous pressing will increment the delay hours. Select the number of hours you want to delay the start of the cycle. Then press START/RESET.
- After closing the door, the machine will count down and automatically start at the correct time.

NOTE: To cancel the DELAY START selection before the cycle begins, press the DELAY START pad until the display is blank. Pressing START/RESET will not cancel delay hours.

3 ADDED HEAT—When selected, the cycle will run longer with heating elements on to improve both wash and dry performance.

NOTE: Cannot be selected with RINSE ONLY cycle.

4 PRE WASH— For use with heavily soiled and/or dried-on, baked-on soils. This option (on some models) MUST be selected PRIOR to starting the cycle. This option adds 16 minutes to the cycle time.

NOTE: Cannot be selected with RINSE ONLY cycle.

**5 HEATED—
DRY**

When selected, turns the drying heater and fan on for fast drying. This option will extend the cycle time by 30 minutes for the ANTI-BACTERIAL cycle, 38 minutes for the NORMAL cycle and COOKWARE cycle, 8 minutes for the SPEED cycle, 15 minutes for the PLASTICS cycle and 30 minutes for all other cycles. When this is NOT selected, the fan will turn on to dry your dishes without added heat—and energy is saved.

NOTE: Cannot be selected with RINSE ONLY cycle.

6 LOCK —

You can lock the controls to prevent any selections from being made. Or you can lock the controls after you have started a cycle.

Children cannot accidentally start the dishwasher by touching pads with this option selected.

To lock the dishwasher controls, press and hold the HEATED DRY pad for 3 seconds. The LOCK light will turn on. To unlock the dishwasher controls, press and hold the HEATED DRY pad for 3 seconds. The LOCK light will turn off.

7 Status Indicator Lights (indicators vary by model)

The Status display tells you what is happening while the dishwasher is in operation. The lights will come ON, indicating the sequence of the dishwasher operation.

SENSING	Displayed while the ExtraClean™ Sensor is measuring the amount of soil and temperature of water. The dishwasher will adjust the selected cycle to achieve optimal performance.
ADD-A-DISH	Displayed during prewash indicating that dishes added now will still be cleaned.
WASHING	Displayed during prewash, main wash and rinse periods.
DRYING	Displayed during HEATED DRY.
SANITIZED	Displayed when cycle has met sanitization conditions.
CLEAN	Displayed when a wash cycle and enhancements are complete.

8 Time Remaining Display (on some models)

During operation, the display shows the minutes remaining until the cycle is complete. The display may adjust the remaining time while the Sensing light is on. The time displayed at the start of each cycle may change from the factory setting as the unit customizes itself to home use. During a delay start, the display will show hours of time remaining until the cycle starts.

9 START/RESET

START— After selecting the cycle and desired enhancements, press the START/RESET pad to ready the dishwasher to begin the cycle. Close the door to start the cycle or begin the DELAY START countdown. When the cycle starts, the water fill begins and approximately 60 seconds later the wash action begins.

The dishwasher will always display your last selection and enhancements. If you don't want to change the settings, simply press the START/RESET pad to ready the dishwasher and close the door to begin the cycle.

NOTE: If the START/RESET light is flashing, the cycle has been interrupted. Light will stop flashing after the dishwasher automatically pumps out the water. Close the door to allow the water to pump out (this takes approximately 70 seconds). When the light stops flashing, the dishwasher can be reprogrammed and restarted.

Also, if a power failure occurs NORMAL and HEATED DRY will automatically be programmed. Make any new selections and press the START/RESET pad to begin the new cycle.

RESET— Open the door slowly to prevent splash-out. Press the START/RESET pad to cancel the cycle and close the door. Dishwasher will pump out and turn off after 70 seconds.

NOTE: If the START/RESET light is flashing, the cycle has been interrupted. Light will stop flashing after the dishwasher automatically pumps out the water. Close the door to allow the water to pump out (this takes approximately 70 seconds). When the light stops flashing, the dishwasher can be reprogrammed and restarted.

10 Clean—

The CLEAN light is illuminated and a double beep will sound when the selected cycle and enhancements are complete. You may remove the dishes at any time. Note the high-efficiency fan will run quietly for 30 minutes to 4 hours (depending on selected cycle) after the CLEAN light is illuminated to continue drying the dishes. This can be stopped by opening the door and pressing any keypad.

NOTE: To turn off the double beep indicator (or re-activate it if it was previously disengaged), press the HEATED DRY pad 5 times within 3 seconds. A triple beep will sound to indicate the end-of-cycle beep option has been toggled.

Lighting Features (on some models)

Interior Lights (on some models)

The interior Xenon lights provide better visibility for loading and unloading. They come on when the door is opened and turn off when the door is latched. The lights will turn off after 15 minutes if the door remains unlatched. To turn the lights back on latch and reopen the door.

Do not attempt to replace the bulbs. If light bulb replacement is necessary, please contact the GE Answer Center for service by calling 1-800-626-2000.

End-of-Cycle Indicator Light (on some models)

The end-of-cycle indicator light is located on the right side of the dishwasher, above the handle. This light comes on when the selected cycle and enhancements are complete. The light will stay on until the door is opened. The dishes may be removed at any time.

Note that the high-efficiency fan will run quietly for 30 minutes to 4 hours (depending on the selected cycle) after the end-of-cycle indicator light is illuminated to continue drying the dishes. Opening the door and pressing any keypad will stop the fan.

Water Temperature

The entering water must be at least 120°F (49°C) and not more than 150°F (66°C), for effective cleaning and to prevent dish damage. Check the water temperature with a candy or meat thermometer. Turn on the hot water faucet

nearest the dishwasher, place the thermometer in a glass and let the water run continuously into the glass until the temperature stops rising.

Use a Rinse Agent

A rinse agent improves dry performance, reduces spots and prevents new film build-up on your dishes, glasses, flatware, cookware and plastic. **Jet-Dry®** and **Cascade Rinse Aid®** are recommended rinse agents for Monogram Dishwashers.

The rinse agent dispenser holds 3.5 oz. of rinse agent. Under normal conditions, this will last approximately one month. Try to keep it full, but do not overfill.

To fill the rinse agent dispenser, make sure the dishwasher is fully open.

Turn the dispenser cap to the left and lift it out. Add rinse agent until the indicator window shows full.

Clean up any spilled rinse agent with a damp cloth. Replace the dispenser cap.

The amount of rinse agent released into the final wash can be adjusted. The factory setting is at the midpoint. If there are rings of calcium (hard water) spots on dishes, try a higher setting. If there is foaming, use a lower setting.

To adjust the setting, remove the dispenser cap; then turn the adjuster counterclockwise to increase the amount of rinse agent.

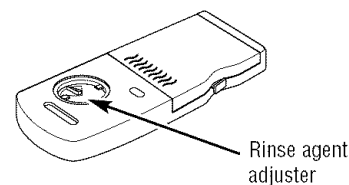
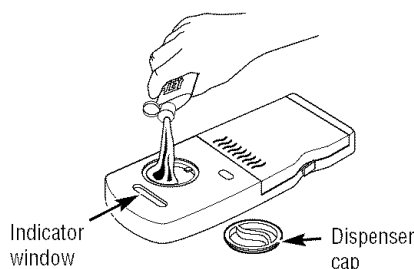

Dish Preparation Prior to Loading

- No prerinsing of normal food soil is required.
- Scrape off hard soils, including bones, toothpicks, skins and seeds.
- Remove large quantities of any remaining food.
- Remove leafy vegetables, meat trimmings and excessive amounts of grease or oil.
- Remove acidic food soils that can discolor stainless steel.

Forget to Add a Dish?

- A forgotten dish can be added any time before the main wash.
1. Open the door slightly.
 2. Wait until the water spray action stops. Steam may rise out of the dishwasher.
 3. Add forgotten dishes.
 4. Close the door.

Detergents

Use only detergent specifically made for use in dishwashers. **Cascade®**, **Cascade Complete®** and **Electrasol®** Automatic Dishwashing Detergents have been approved for use in all Monogram Dishwashers. Keep your powdered detergent fresh and dry. Don't put detergent into the dispenser until you're ready to wash dishes.

All wash cycles except RINSE ONLY require detergent. The amount of detergent to use depends on whether your water is *hard* or *soft*.

Protect your dishes and dishwasher by contacting your water department and asking how hard your water is. Twelve or more grains is extremely hard water. A water softener is recommended. Without it, lime can build up in the water valve, which could stick while open and cause flooding. Too much detergent with soft water can cause a permanent cloudiness of glassware, called *etching*.

The detergent cup has indicator lines to help you. Use the right amount of detergent. As a guide:

For Soft water (water hardness <4 Grains Per Gallon, GPG), fill cup to the first line.

For Medium water (4–8 GPG), fill cup to the second line.

For Medium hard water (8–12 GPG), fill cup.

For Extremely hard water (>12 GPG), fill both cups.

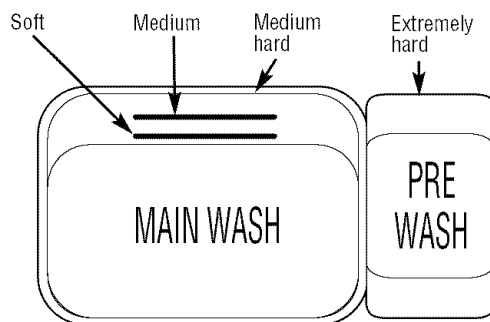

To fill the dispenser, if the dispenser is closed, open the cover by depressing the cover latch. Add detergent to the Main Wash section, as per guidelines. Fill the Pre-wash section if water is extremely hard. Then close the dispenser cover. It is normal for the cover to open partially when dispensing detergent.

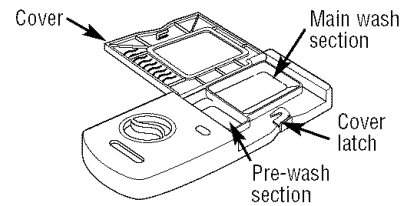

Do not use hand dish detergent.

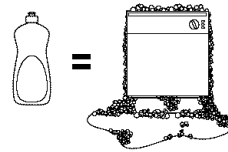

NOTE: Using a detergent that is not specifically designed for dishwashers will cause the dishwasher to fill with suds. During operation, these suds will spill out of the dishwasher

vents, covering the kitchen floor and making the floor wet.

Because so many detergent containers look alike, store the dishwasher detergent in a separate space from all other cleaners. Show anyone who may use the dishwasher the correct detergent and where it is stored.

While there will be no lasting damage to the dishwasher, your dishes will not get clean using a dishwashing detergent that is not formulated to work with dishwashers.

Drying Fan (on some models)

Top Control Panel models are equipped with a drying fan to assist in drying dishes by pulling air through the tub after the wash cycle.

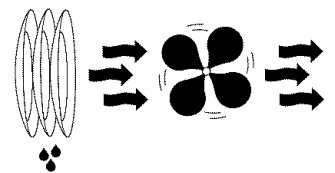

If the Heated Dry option is selected, then the drying fan will run during the drying portion of the cycle and up to 2 hours after the CLEAN light is on, depending on the selected wash cycle. If the Heated Dry option is not used, then the CLEAN light will come on at the end of the final rinse and the fan will run up to 4 hours, depending on the selected wash cycle.

If the Rinse Only wash cycle is selected, the Heated Dry option is automatically turned off and the drying fan will run for 4 hours.

If the drying fan is running and the CLEAN light is on, the drying fan can be turned off by opening the door and pressing any key on the keypad.

Upper Rack

Features and appearance of racks and silverware basket may vary from your model.

Although the upper rack is for glasses, cups and saucers, pots and pans can be placed in this rack for effective cleaning. Cups and glasses fit best along the sides and should be placed open-end down. This is also a secure place for dishwasher plastics.

The utility shelf (on some models) may be placed in the up or down position to add flexibility.

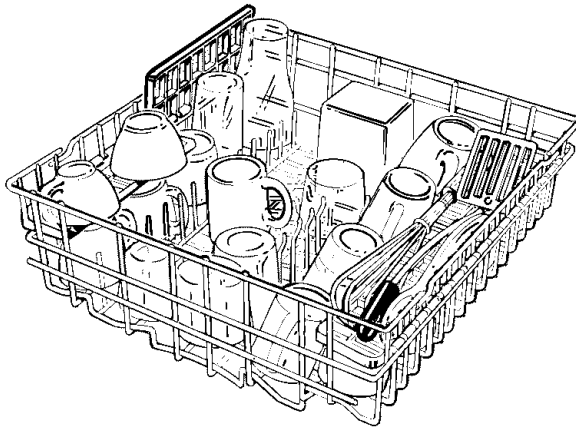

A wine glass holder (on some models) secures wine glasses for best washability. Because wine glasses come in various sizes, after loading, slowly push in the rack to make sure they will clear the top of the dishwasher.

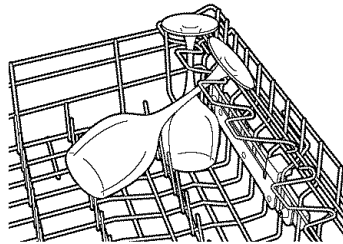

The upper rack is good for all kinds of odd-shaped utensils. Saucepans, mixing bowls and other items should be placed face down. Fold-down tines (on some models) provide flexibility for extra-large and hard-to-fit items.

Secure larger dishwasher-safe plastics over 2 tines when possible.

Make sure small plastic items are secure so they can't fall onto the heater.

Be sure that items do not protrude through the bottom of the rack and block rotation of the middle spray arm. This could result in poor wash performance for items in the upper rack.

Check to make sure that no items will block rotation of the wash arm.

Adjustable Upper Rack (on some models)

The standard position of your adjustable rack is “up” which allows for maximum clearance for your taller items in the lower rack. If you have taller wine glasses, tumblers or other items to place in the upper rack, you may want to adjust the rack to the lower position.

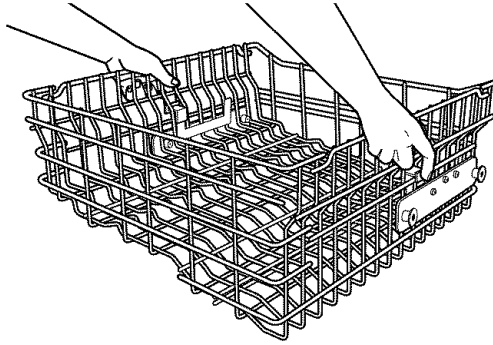

To lower the rack, support the weight of the rack with your hands as shown and press both finger pads about 1/4” toward the inside of the rack as indicated and guide the rack down to its lower position.



To raise the rack to the “up” position, pull up on the center of the rack side frame until the rack locks into place.

Silverware Basket

To load flatware, simply push the adjustable handle to either side (on some models).

Put flatware in the removable basket with fork and knife handles up to protect your hands. Place spoons in the basket with handles down. Mix knives, forks and spoons so they don't nest together. Distribute evenly. Small plastic items, such as measuring spoons and lids from small containers should go in the bottom of the silverware basket with the silverware on top.

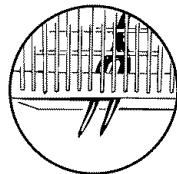

Don't let any item extend through bottom.

The one-piece silverware basket can be placed in the front, right side or back of the lower rack.

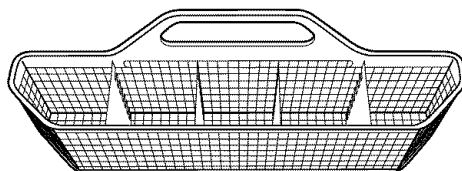

One-piece basket (on some models)

A variety of options are available regarding the three-piece silverware basket (on some models) in your dishwasher. The complete basket is designed to fit on the right side of the lower rack. Additionally, each end of the basket is removable to add loading flexibility to accommodate flatware and lower rack capacity needs.

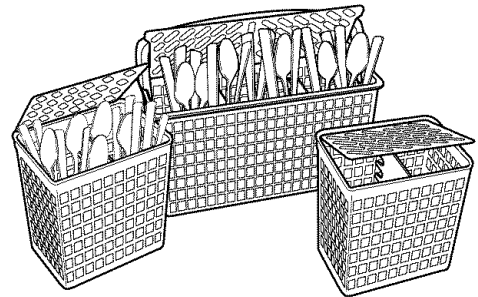

Three-piece basket (on some models)

The lids of both end and middle baskets (on some models) can be closed to contain small items. Long items can be placed on the utility shelf in the upper rack.

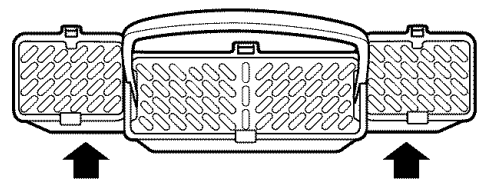

To remove end baskets, grasp the basket at opposite corners and slide apart.

Lower Rack

The lower rack is best used for plates, saucers and cookware. Large items such as broiler pans and baking racks should go along the left-hand side. Load platters, pots and bowls along the sides, in corners or in the back. The soiled side of items should face the center of the rack. If necessary, oversized glasses and mugs can be placed in the lower rack to maximize loading flexibility.

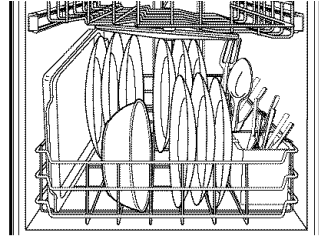

Also, be careful not to let a portion of an item such as a pot or dish handle extend through the bottom rack. This could block the wash arm and cause poor washing results.

Fold-down tines (on some models) provide flexibility for extra-large and hard-to-fit items. The tines may be left in the up position or folded down to customize the lower rack.

Remove the Upper Rack

You can remove the upper rack to allow space for large items in the lower rack.

To remove the upper rack, push thumb tab out and remove the front end caps on each side of the rail.

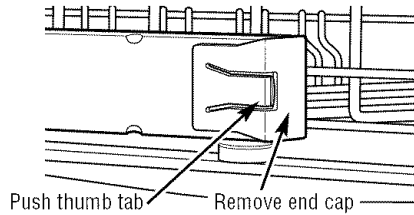

Pull the rack straight out and off the rails.

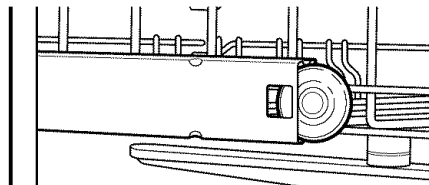

Replace the end caps, then push the rails all the way back into the dishwasher. Slide the shower nozzle attachment over the spout.

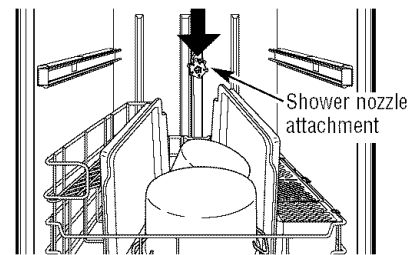

Then fill the lower rack and begin your cycle.

NOTE: Nozzle must be in place with upper rack removed. If not installed properly, poor wash performance and noise will result.

NOTE: Don't forget to remove the shower nozzle attachment before you replace the upper rack.

Extra Rack Features (on some models)

Cutlery Tray

The cutlery tray holds up to 4 large knives such as a carver, chef's knives, bread knife, etc., that are too tall to fit in the silverware basket.

Hook the tray onto the rear of the upper rack. Lay the knives between the guides (as shown).

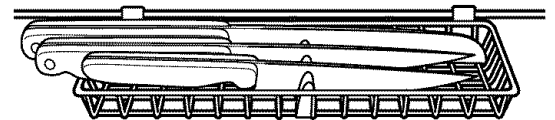

Bowl Tines

The special large-bowl tines in the lower rack add flexibility to your loading pattern. They are useful for serving bowls or other large bowls.

To use the bowl tines, fold down the 2 rows of flex tines in front of the bowl tines and load bowls just as you would in the upper rack.

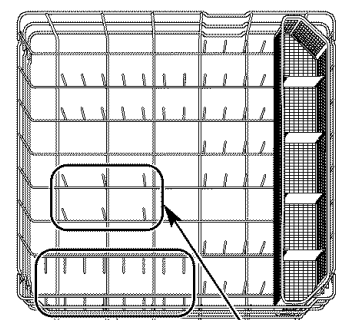

These tines fold down Large-bowl tines

Loading the Racks

Dishwasher

Follow these guidelines for loading 10 and 12 place settings

Features and appearance of racks and silverware baskets may vary from your model.

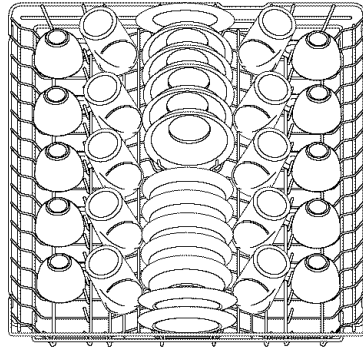

Upper Rack—10 place settings

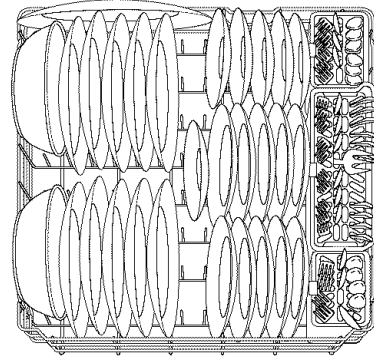

Lower Rack—10 place settings

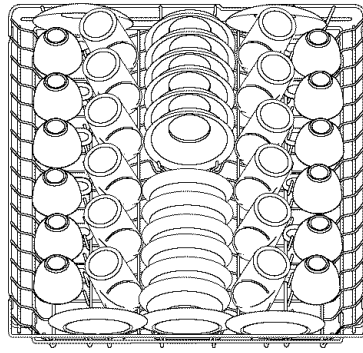

Upper Rack—12 place settings

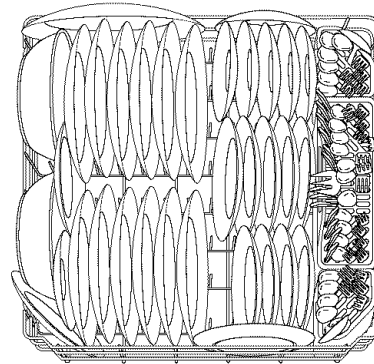

Lower Rack—12 place settings

Exterior

To clean the control panel use a lightly dampened cloth then dry thoroughly. To clean the exterior painted panels use a good appliance polish wax.

Never use sharp objects, scouring pads or harsh cleaners on any part of the dishwasher.

The stainless steel panels can be cleaned with CERAMA BRYTE® Stainless Steel Appliance Cleaner or a similar product using a clean, soft cloth. You can order CERAMA BRYTE® Stainless Steel Appliance Cleaner through GE Parts by calling 800.626.2002 (for U.S. only). In Canada, call 1.888.880.3030.

Interior

The stainless steel used to make the dishwasher tub and inner door provides the highest reliability available in a GE dishwasher. If the dishwasher tub or inner door should be scratched or dented during normal use, they will not rust or corrode. These surface blemishes will not affect their function or durability.

Protect Against Freezing

If your dishwasher is left in an unheated place during the winter, ask a service technician to:

1. Cut off electrical power to the dishwasher. Remove fuses or trip circuit breaker.
 2. Turn off the water supply and disconnect the water inlet line from the water valve.
 3. Drain water from the water inlet line and water valve. (Use a pan to catch the water.)
 4. Reconnect the water inlet line to the water valve.
-

The Air Gap

An air gap protects your dishwasher against water backing up into it if a drain clogs. The air gap is not a part of the dishwasher. It is not covered by your warranty. Not all plumbing codes require air gaps, so you may not have one.

The air gap is easy to clean.

1. Turn off the dishwasher and lift off the chrome cover.
2. Unscrew the plastic cap and clean with a toothpick.

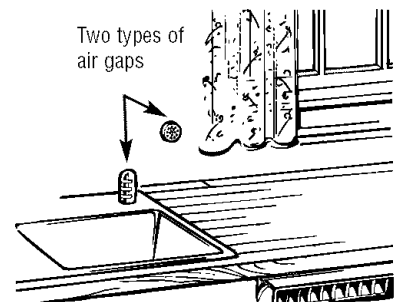

Check the air gap any time your dishwasher isn't draining well.

Before You Call For Service

Dishwasher

*Questions?
Use this
problem
solver*

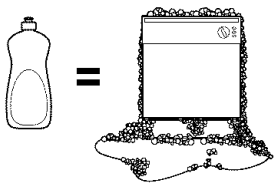
PROBLEM	POSSIBLE CAUSE	WHAT TO DO
Control panel lights go off when you're setting controls	Time too long between touching of selected pads	<ul style="list-style-type: none"> Each pad must be touched within 30 seconds of the others. To relight, touch any pad again, or unlatch and relatch door.
Noise	Some of the sounds you will hear are normal	<ul style="list-style-type: none"> Detergent cup opening. The motor stopping during the drying period. Water draining out of the tub immediately after you touch START/RESET pad. Drying fan running for 2–4 hours after CLEAN light is illuminated (Top Control Panel models only).
	Utensils are not secure in the rack or something small has dropped into the rack	<ul style="list-style-type: none"> Make sure everything is secured in dishwasher.
	Motor hums	<ul style="list-style-type: none"> Dishwasher has not been used on a regular basis. If you do not use your dishwasher often, run a RINSE ONLY cycle once every week. This will help keep the seal moist.
Detergent left in dispenser cups	Dishes are blocking the detergent cups	<ul style="list-style-type: none"> Reposition the dishes.
Water standing in the bottom of the tub	This is normal	<ul style="list-style-type: none"> A small amount of clean water around the outlet on the tub bottom at the back of the tub keeps the water seal lubricated.
Water won't pump out of the tub	Drain is clogged	<ul style="list-style-type: none"> If you have an air gap, clean it. Check to see if your kitchen sink is draining well. If not, you may need a plumber. If the dishwasher drains into a disposer, run disposer clear.
Suds 	Correct detergent wasn't used	<ul style="list-style-type: none"> Use only automatic dishwasher detergents to avoid sudsing. Cascade®, Cascade Complete® and Electrasol® dishwasher detergents have been approved for use in all Monogram dishwashers. To remove suds from the tub, open the dishwasher and let suds dissipate. Add 1 gallon of cold water to the tub. Pump out water by starting any cycle and then resetting the unit after 10 seconds. See Control Panel section. Repeat if necessary.
	Rinse agent was spilled	<ul style="list-style-type: none"> Always wipe up rinse agent spills immediately.
Stained dishwasher parts	Detergent with colorant was used	<ul style="list-style-type: none"> Some detergents contain colorant (pigment or dyes) that will discolor the tub interior with extended use. Check the detergent cup for signs of any discoloration. If cup is discolored, change to detergent without any colorant. Cascade®, Cascade Complete® and Electrasol® dishwasher detergents have been approved for use in all Monogram dishwashers.
	Some tomato-based foods can stain	<ul style="list-style-type: none"> Use of the RINSE ONLY cycle after adding the dish to the load can decrease the level of staining. GE also recommends Cascade® Plastic Booster™ to help remove these types of stains.

*Questions?
Use this
problem
solver*

PROBLEM	POSSIBLE CAUSE	WHAT TO DO
Dishes and flatware not clean	Low inlet water temperature	<ul style="list-style-type: none"> • Make sure inlet water temperature is correct (see Using the Dishwasher section). • Run water at the nearest faucet prior to starting the dishwasher to insure optimal water temperature.
	Water pressure is temporarily low	<ul style="list-style-type: none"> • Turn on a faucet. Is water coming out more slowly than usual? If so, wait until pressure is normal before using your dishwasher.
	Air gap is clogged	<ul style="list-style-type: none"> • Clean air gap.
	Improper rack loading	<ul style="list-style-type: none"> • Make sure large dishware does not block the detergent dispenser or the wash arms. • Glasses and dishes must face the spray arms.
Spots and filming on glasses and flatware	Extremely hard water Low inlet water temperature Overloading the dishwasher Improper loading Old or damp powder detergent Rinse agent dispenser empty Too little detergent	<ul style="list-style-type: none"> • Use Jet Dry® or Cascade Rinse Aid® rinse agent to remove spots and prevent new film buildup. • Install water softener. • To remove stubborn spots and pre-existing film from glassware: <ol style="list-style-type: none"> 1 Remove all metal utensils from the dishwasher. 2 Do not add detergent. 3 Select the COOKWARE cycle. 4 Start the dishwasher and allow to run for 18 to 22 minutes. Dishwasher will now be in the main wash. 5 Open the door and pour 2 cups (500 ml) of white vinegar into the bottom of the dishwasher. 6 Close the door and allow to complete the cycle. If vinegar rinse doesn't work: Repeat as above, except use 1/4 cup (60 ml) of citric acid crystals instead of vinegar.
Cloudiness on glassware	Combination of soft water and too much detergent	<ul style="list-style-type: none"> • This is called <i>etching</i> and is permanent. To prevent this from happening, use less detergent if you have soft water. Wash glassware in the shortest cycle that will get it clean.
	Water temperature entering the dishwasher exceeds 150°F (66°C)	<ul style="list-style-type: none"> • Lower the water heater temperature.
Black or gray marks on dishes	Aluminum utensils have rubbed against dishes	<ul style="list-style-type: none"> • Remove marks with a mild, abrasive cleaner.

Before You Call For Service

Dishwasher

*Questions?
Use this
problem
solver*

PROBLEM	POSSIBLE CAUSE	WHAT TO DO
Yellow or brown film on inside surfaces	Tea or coffee stains	<ul style="list-style-type: none"> Remove the stain by hand, using a solution of 1/2 cup bleach and 3 cups warm water. ▲ CAUTION: Before cleaning interior, wait at least 20 minutes after a cycle for the heating element to cool down. Failure to do so can result in burns.
	An overall yellow or brown film can be caused by iron deposits in water	<ul style="list-style-type: none"> A special filter in the water supply line is the only way to correct this problem. Contact your GE dealer or a water softener company
White film on inside surfaces	Hard water minerals	<ul style="list-style-type: none"> GE recommends Jet Dry® Dishwasher Cleaner to help remove some hard water and mineral stains. For extreme staining, clean the interior by applying dishwasher detergent to a damp sponge. Wear rubber gloves. DO NOT use any type of cleanser other than those recommended or dishwasher detergent because it may cause foaming or sudsing. Cascade®, Cascade Complete® and Electrasol® Automatic Dishwashing Detergents have been approved for use in all Monogram Dishwashers. ▲ CAUTION: Before cleaning interior, wait at least 20 minutes after a cycle for the heating element to cool down. Failure to do so can result in burns.
Dishes don't dry	Low inlet water temperature	<ul style="list-style-type: none"> Make sure inlet water temperature is correct (see Using the Dishwasher section). Select ADDED HEAT. Select HEATED DRY.
	Rinse agent dispenser is empty	<ul style="list-style-type: none"> Check and refill the rinse agent dispenser.
Dishwasher won't run	Fuse is blown, or the circuit breaker tripped	<ul style="list-style-type: none"> Replace fuse or reset circuit breaker. Remove any other appliances from the circuit. Try resetting the START/RESET pad.
	Wall switch (some installations) is in the "off" position	<ul style="list-style-type: none"> Check for a wall switch that the dishwasher might be connected to. A wall switch is required by electrical codes in some localities. Turn the switch "on" if it is "off."
Steam	This is normal	<ul style="list-style-type: none"> Steam comes through the vent on the bottom of the door during drying and when water is being pumped out.

Before You Call For Service

Dishwasher

*Questions?
Use this
problem
solver*

PROBLEM	POSSIBLE CAUSE	WHAT TO DO
Sanitized light does not illuminate at the end of the cycle (Anti-Bacteria cycle only)	The door was opened and the cycle was interrupted during or after the main wash portion	<ul style="list-style-type: none">• Do not interrupt the cycle anytime during or after main wash.
	Low inlet water temperature	<ul style="list-style-type: none">• Raise the water heater temperature to 120°F (49°C).
Interior lights not working	Door was open for more than 15 minutes	<ul style="list-style-type: none">• Latch the door and reopen.
	Bulbs are burnt out	<ul style="list-style-type: none">• Call for service to replace bulbs.
End-of-cycle indicator light does not illuminate	Dishwasher has not completed cycle	<ul style="list-style-type: none">• Open the door and check the status indicator lights on control panel to determine if cycle is complete.

With the purchase of your new Monogram appliance, receive the assurance that if you ever need information or assistance from GE, we'll be there. All you have to do is call—toll-free!

GE Answer Center®

***In the USA:
800.626.2000***

Whatever your question about any Monogram major appliance, GE Answer Center® information service is available to help. Your call—and your question—will be answered promptly and courteously. And you can call any time. GE Answer Center® service is open 24 hours a day, 7 days a week.

OR

Visit our Website at: www.monogram.com

In Canada, call 1.888.880.3030.

In-Home Repair Service

***In the USA:
800.444.1845***

***In Canada:
1.888.880.3030***

A GE consumer service professional will provide expert repair service, scheduled at a time that's convenient for you. Many GE Consumer Service company-operated locations offer you service today or tomorrow, or at your convenience (7:00 a.m. to 7:00 p.m. weekdays, 9:00 a.m. to 2:00 p.m. Saturdays). Our factory-trained technicians know your appliance inside and out—so most repairs can be handled in just one visit.

For Customers With Special Needs...

***In the USA:
800.626.2000***

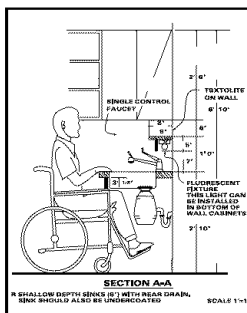

GE offers Braille controls for a variety of GE appliances, and a brochure to assist in planning a barrier-free kitchen for persons with limited mobility.

Consumers with impaired hearing or speech who have access to a TDD or a conventional teletypewriter may call 800.TDD.GEAC (800.833.4322) to request information or service.

Service Contracts

***In the USA:
800.626.2224***

***In Canada:
1.888.880.3030***

You can have the secure feeling that GE Consumer Service will still be there after your warranty expires. Purchase a GE contract while your warranty is still in effect and you'll receive a substantial discount. With a multiple-year contract, you're assured of future service at today's prices.

Parts and Accessories

***In the USA:
800.626.2002***

***In Canada:
1.888.880.3030***

Individuals qualified to service their own appliances can have parts or accessories sent directly to their home. The GE parts system provides access to over 47,000 parts...and all GE Genuine Renewal Parts are fully warranted.

User maintenance instructions contained in this manual cover procedures intended to be performed by any user. Other servicing generally should be referred to qualified service personnel. Caution must be exercised, since improper servicing may cause unsafe operation.

YOUR MONOGRAM DISHWASHER WARRANTY

Staple sales slip or cancelled check here. Proof of original purchase date is needed to obtain service under warranty.

WHAT IS COVERED

From the Date of the Original Purchase

ONE-YEAR

Any part of the dishwasher which fails due to a defect in materials or workmanship. During this **full one-year warranty**, GE will also provide, **free of charge**, all labor and in-home service to replace the defective part.

Second Year

Any part of the dishwasher which fails due to a defect in materials or workmanship. During this **second-year limited warranty**, you will be responsible for any labor or in-home service costs.

Five Years

The dishwasher rack and/or the electronic control module, if these should fail due to a defect in materials or workmanship. During this **five-year limited warranty**, you will be responsible for any labor or in-home service costs.

Lifetime

The stainless steel tub or door liner, if it fails to contain water due to a defect in materials or workmanship. During this **full lifetime warranty**, GE will also provide, **free of charge**, all labor and in-home service to replace the defective part.

.....
This warranty is extended to the original purchaser and any succeeding owner for the products purchased for ordinary home use in the 48 mainland states, Hawaii, Washington, D.C. or Canada. In Alaska the warranty is the same except that it is LIMITED because you must pay to ship the product to the service shop or for the service technician's travel cost to your home.

All warranty service will be provided by our Factory Service Centers or by our authorized Customer Care® servicers during normal working hours.

Should your appliance need service, during warranty period or beyond, in the U.S.A. call 800.444.1845. In Canada: 888.880.3030.

WHAT IS NOT COVERED

- Service trips to your home to teach you how to use the product.
- Improper installation, delivery or maintenance.
- Replacement of house fuses or resetting of circuit breakers.
- Failure of the product if it is abused, misused, or used for other than the intended purpose or used commercially.
- Damage to the product caused by accident, fire, floods or acts of God.
- Incidental or consequential damage caused by possible defects with this appliance.
- Cleaning or servicing of the air gap device in the drain line.
- Damage caused after delivery including damage from items dropped on the door.

Some states do not allow the exclusion or limitation of incidental or consequential damages, so the above limitation or exclusion may not apply to you. This warranty gives you specific legal rights, and you may also have other rights which vary from state to state. To know what your legal rights are in your state, consult your local or state consumer affairs office or your state's Attorney General.

Warrantor: General Electric Company, Louisville, KY 40225.

YOUR MONOGRAM DISHWASHER WARRANTY

Staple sales slip or cancelled check here. Proof of original purchase date is needed to obtain service under warranty.

WHAT IS COVERED

From the Date of the Original Purchase

ONE-YEAR

Any part of the dishwasher which fails due to a defect in materials or workmanship. During this full one-year warranty, GE will also provide, free of charge, all labor and in-home service to replace the defective part.

Second Year

Any part of the dishwasher which fails due to a defect in materials or workmanship. During this second-year limited warranty, you will be responsible for any labor or in-home service costs.

Five Years

The dishwasher rack, if it should rust, or the electronic control module, if it should fail due to a defect in materials or workmanship. During this five-year limited warranty, you will be responsible for any labor or in-home service costs.

Lifetime

The stainless steel tub or door liner, if it fails to contain water due to a defect in materials or workmanship. During this full lifetime warranty, GE will also provide, free of charge, all labor and in-home service to replace the defective part.

.....
This warranty is extended to the original purchaser and any succeeding owner for products purchased for ordinary home use in Canada. Proof of original purchase date is needed to obtain service under the warranty.

All warranty service will be provided by our Factory Service Centers or by our authorized Customer Care® servicers during normal working hours.

Should your appliance need service, during warranty period or beyond, call 1.888.880.3030.

WHAT IS NOT COVERED

- Service trips to your home to teach you how to use the product.
- Improper installation, delivery or maintenance.
- Replacement of house fuses or resetting of circuit breakers.
- Failure of the product if it is abused, misused, or used for other than the intended purpose or used commercially.
- Damage to the product caused by accident, fire, floods or acts of God.
- Incidental or consequential damage caused by possible defects with this appliance.
- Cleaning or servicing of the air gap device in the drain line.
- Damage caused after delivery including damage from items dropped on the door.

Some provinces do not allow the exclusion or limitation of incidental or consequential damages, so the above limitation or exclusion may not apply to you. This warranty gives you specific legal rights, and you may also have other rights which vary from province to province. To know what your legal rights are in your province, consult your local or provincial consumer affairs office.

Warrantor: Camco Inc., 1 Factory Lane, Suite 310, Moncton, N.B. E1C 9M3.

**Consumer Product
Ownership Registration
Important Mail Today**

GE Appliances



Place
1st Class
Letter
Stamp
Here

**General Electric Company
Warranty Registration Department
P.O. Box 34980
Louisville, KY 40232-2150**

Consumer Product Ownership Registration

Dear Customer:

Thank you for purchasing our product and thank you for placing your confidence in us. We are proud to have you as a customer!

Follow these three steps to protect your new appliance investment:



1

Complete and mail your Consumer Product Ownership Registration today. Have the peace of mind of knowing we can contact you in the unlikely event of a safety modification.

2

After completing this registration, write your model and serial numbers in this manual and store this document in a safe place. You will need this information should you require service. The service number in the USA: 800.444.1845. In Canada: 1.888.880.3030.

3

Read your "Owner's Manual" carefully. It will help you operate your new appliance properly.

Important: If you did not get a registration card with your product, detach and return the form below to ensure that your product is registered, or register online at www.monogram.com.

FOLD HERE

Consumer Product Ownership Registration



Product

Dishwasher

Model Number

Serial Number

Mr. Ms. Mrs. Miss

First Name

Last Name

Street Address

Apt. #

E-mail Address*

City

State

Zip Code

Date Placed In Use
Month

Day

Year

Phone Number



GE Consumer & Industrial
Louisville, KY 40225

www.monogram.com

* Please provide your e-mail address to receive, via e-mail, discounts, special offers and other important communications from GE Appliances (GEA).

Check here if you do not want to receive communications from GEA's carefully selected partners.

FAILURE TO COMPLETE AND RETURN THIS CARD DOES NOT DIMINISH YOUR WARRANTY RIGHTS.

For information about GEA's privacy and data usage policy, go to www.monogram.com and click on "Privacy Policy" or call 800.626.2224.



TAPE CLOSED

165D4700P304

49-5980

11-04 JR

Printed in the United States



Monogram®

GE Consumer & Industrial
Louisville, KY 40225

©2004 GE Company

165D4700P304

49-5980

11-04 JR

Imprimé aux États-Unis



Monogram.[®]

*GE Consumer & Industrial
Louisville, KY 40225*

©2004 GE Company