

This Owner's Manual is provided and hosted by [Appliance Factory Parts](#).

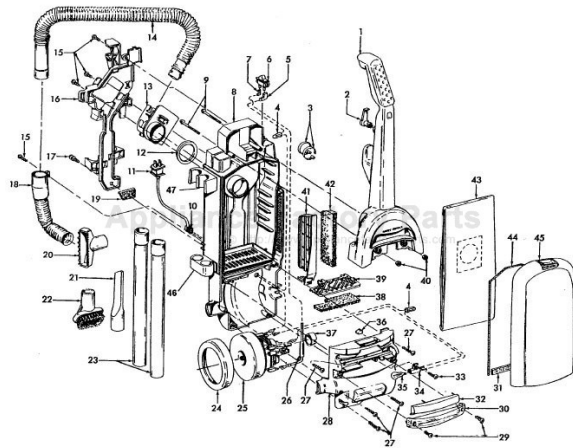

HOOVER U5398-990 Owner's Manual

[Shop genuine replacement parts for HOOVER
U5398-990](#)



[Find Your HOOVER Vacuum Cleaner Parts - Select From 1456 Models](#)

----- Manual continues below part list -----

Available Replacement Parts for HOOVER U5398-990

H-4010100Y	BAG VACUUM CLEANER OEM HOOVER 3 PACK
HR-1805	FITLER HOOVER 2 PACK AFTERMARKET
HR-1832	FILTER FOR VACUUM 2 pack
HR-2013	BRUSHROLLER 12.25 IN
HR-2015	ROLLER BRUSH ASSY
K-109289	BULB
FA-3035	ATTACHMENT CORD ASSY
H-36426034	Secondary filter retainer.
H-43244005	Rear wheel
H-40110004	FOAM FILTER,2PK, READ EXT INFO
H-43248057	front wheel assy
H-38528033	BELT, FLAT, 1PK

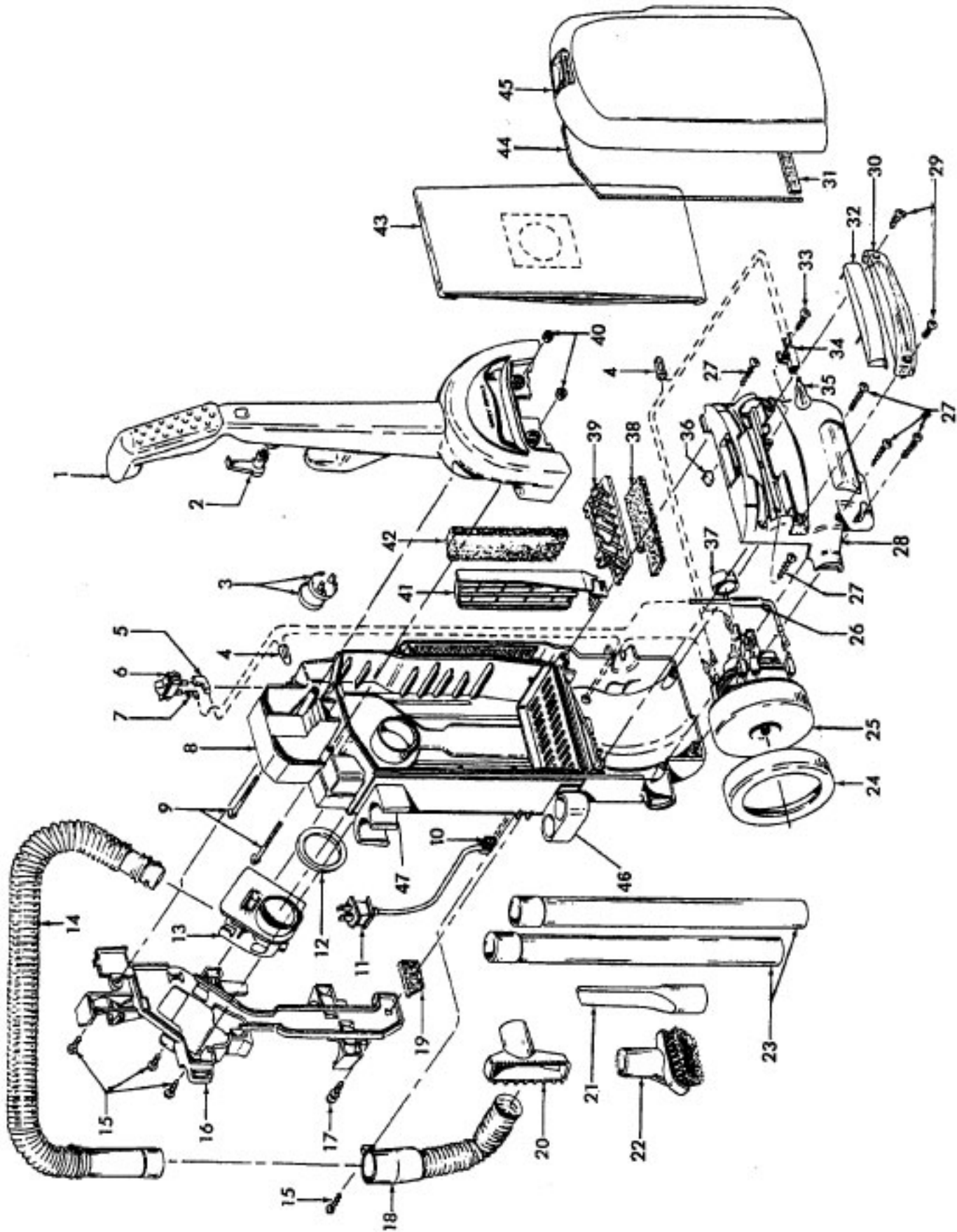

WindTunnel

Models U5330-900, U5393-900, U5394-900, U5395-900, *U5395-940,
U5395-960, *U5395-970, U5396-900, **U5396-960, U5397-900, U5398-900,
*****U5398-990, U5399-900**

Ref. No.	Part No.	Description	Ref. No.	Part No.	Description
1	48663206	Upper Handle Assm. (Inc. item 2)	39	36426034	Secondary Filter Retainer
2	3944201P	Cord Wrap - ABE	40	21641558	* Hex Nut (2)
3	27479307	* Wire Tie		40201149	Handle Hardware (Inc. It. 9)
4	27618508	* Wire Connector	41	36426038	Filter Holder - ABE
5	N/A	Terminal	42	38766008	Final Filter
6	28161063	Switch - 3/16" terminals		40110004	Final Filter Pack (3 Layer - Qty. 2)
	28161067	Switch - 1/4" terminals (See note 1)	43	4010100Y	Throw Away Bag (3 pack)
7	N/A	Terminal	44	38781057	Bag Door Gasket
8	37255013	Bag Housing - ABE	45	Note: All Bag Housing Doors include items 31 & 44	
	37255018	Bag Housing - AG - U5394-900,U5399-900		37254096	Bag Housing Door - ABY
9	40201149	Handle Hardware (Inc. item 40)		37254089	+ Bag Hsg. Door - ACL - U5397-900
10	27482301	Strain Relief		37254115	Bag Hsg. Door - AG - U5393-900
	27482230	Strain Relief - U5395-960,U5395-970, U5396-900,U5397-900, U5398-900		42255080	+ Bag Hsg. Door - ABR - U5396-900
11	46383322	Cord - 35 Ft. - with 3/16" terminals		42255101	Bag Hsg. Door - ACX - U5330-900
	46383334	Cord - 35 Ft. - with 1/4" terminals (See note 1)		42255107	Bag Hsg. Door - ABR - U5398-900
12	31178017	Hose Connector Gasket		42255064	Bag Hsg. Door - ACF- U5394-900
13	38641005	Hose Connector (also order it. 12)		42255065	Bag Hsg. Door - ABY- U5399-900
14	43434248	Hose Assembly	46	36433116	Lower Wand Holder
	43434031	Hose Assembly - U5395-960 U5395-970, U5396-900	47	36433117	Upper Wand Holder
15	21447242	Screw (4)	Items not illustrated		
16	36433112	Tool / Hose Holder - ABE		56511A72	Owner Manual - U5393-900
17	23149002	Screw		56511A66	Owner Manual -U5399-900
18	43431005	Angled Connector Assem. w/Hose Door		58185186	Carton
19	34311004	Wire Opening Seal		58185217	Carton - U5393-900
20	3861401E	Furniture Nozzle - ABR		12910	Attach. Cord Clamp
21	38617027	Crevice Tool - ABR		43457024	Nozzle Hose Extension - U5395-960, U5396-900
	38617029	Crevice Tool - Long - U5398-900		51151010	Indicator Assem. - U5396-900, U5397-900, U5394-900, U5399-900
22	43414162	Dusting Brush Assembly - ABR		49811059	Lead Wire - Red - w/ 3/16" terminal
23	38634078	Extension Tube - AG (2)		49811073	Lead Wire - Red - w/ 1/4" terminal (See note 1)
24	36322035	Motor Mount - Large		43434042	Hose - 20' Stretch - U5396-960
25	43576188	Motor Assembly	Main Body and related components (P. 325)		
	41311017	Motor Brushes (2)	Note 1: Models produced after June 2000 incorporated 14 gauge wiring and associated electrical components with 1/4" terminals. Ref. Service Bulletin 4-00.		
	43566016	Motor Fan Assembly	* Model U5395-970 is identical to model U5395-900 except for addition of deluxe hose and six extra allergen filtration bags.		
26	47534027	Thermal Protector - w/ 3/16" terminals	** Model U5395-960 is identical to model U5395-900 except for addition of deluxe hose and nozzle hose extension.		
	28382087	Thermal Protector - w/ 1/4" terminals (See note 1)	*** Models U5395-940 is identical to model U5395-900 except for additional 6 Throw-away bags.		
	51873001	Thermal Protector Label	****Model U5396-960 is identical to model U5396-900 except for the addition of the 20' hose.		
27	21447230	* Screw (5)	*****Model U5398-990 is identical to model U5398-900 except for the addition of a turbine powered hand tool.		
28	37196009	Motor Cover - ABE			
	37196158	Motor Cover - ABE - U5394-900			
29	21447228	* Screw (2)			
30	39383107	Lens			
31	34123050	Bag Door Gasket - Bottom			
32	37944010	Cover - ABE			
33	21447072	* Screw			
34	47173023	Wiring Harness - w/ 3/16" terminals			
	47173027	Wiring Harness - w/ 1/4" terminals (See note 1)			
35	27313101	Dirt Finder Lamp			
36	34131019	Wire Opening Plug			
37	36322030	Motor Mount - Small			
38	38765019	Secondary Filter			

WindTunnel Models U5330-900 (15"), U5393-900(13"), U5394-900(13"), U5395-900(13"), ** U5395-940(13"),
 * U5395-960 (13"), U5395-970(13"), U5396-900(15"), ***** U5396-960 (15"), U5397-900(15"),
 U5398-900 (15"), *****U5398-990 (15 IN), U5399-900 (13 IN), U5403-900 (13"), U5433-900(13"),
 U5434-900(13"), U5435-900(13"), U5437-960, U5443-900(15"), U5439-900(13"), ***U5443-940(15"),
 ****U5443-960(15"), U5445-900(15"), *** U5445-940(15"), U5446-900, U5447-900 (15"),
 U5449-940 (15"), U5450-900 (15"), U5451-900(15"), U5454-900 (15"), U5456-900 (15"), U5457-900(15"),
 U5460-900 (15")

WT TurboPOWER Model U5415-900 (13"), U5420-900(15"), U5469-900(13"), U5469-910(15"), U5475-900(15")*****
 U5475-960 (15"), U5477-900 (15")

WT Farrington Model U5436-950, U5452-900 (15")

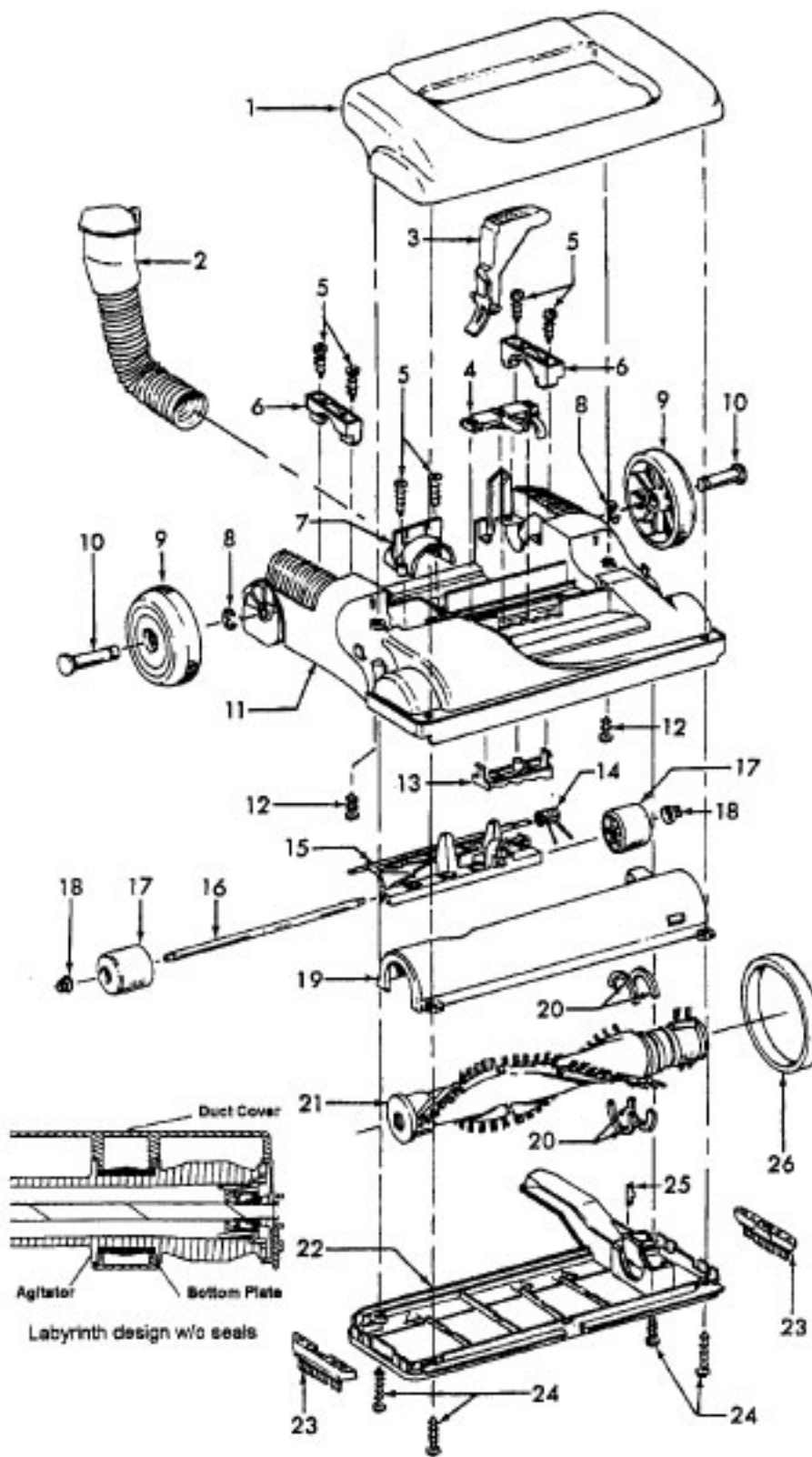

WindTunnel Modelle U5330-900 (15"), U5393-900(13"), U5394-900(13"), U5395-900(13"), ** U5395-940(13"), * U5395-960 (13"), U5395-970(13"), U5396-900(15"), ***** U5396-960 (15"), U5397-900(15"), U5398-900 (15"), *****U5398-990 (15 IN), U5399-900 (13 IN), U5403-900 (13"), U5433-900(13"), U5434-900(13"), U5435-900(13"), U5437-960, U5443-900(15"), U5439-900(13"), ***U5443-940(15"), ****U5443-960(15"), U5445-900(15"), *** U5445-940(15"), U5446-900, U5447-900 (15"), U5449-940 (15"), U5450-900 (15"), U5451-900(15"), U5454-900 (15"), U5456-900 (15"), U5457-900(15"), U5460-900 (15")

WT TurboPOWER Model U5415-900 (13"), U5420-900(15"), U5469-900(13"), U5469-910(15"), U5475-900(15")***** U5475-960 (15"), U5477-900 (15")

WT Farrington Model U5436-950, U5452-900 (15")

Ref. No.	Part No.	Description	Ref. No.	Part No.	Description
1	37253285	Hood - ABY - 13 IN - U5433-900	11	37242124	Main Body - ABE - 13 IN
	37253287	Hood - ABY - 13 IN - U5395-900		37242123	Main Body - ABE - 15 IN
	37253290	Hood - AG - 13 IN - U5469-900	12	21447228	* Screw Self Tapping
	37253307	Hood - ACM - 13 IN - U5403-900	13	40309004	Nozzle Adj. Lever / Cam Assembly (Inc. item 4)
	37253315	Hood - AG - 13 IN - U5393-900	14	38355010	Torsion Spring
	37253342	Hood - ADX - 13 IN - U5434-900	15	43248057	Front Wheel Assem. (Inc items 15, 16, 17, 18)
	37253353	Hood - AG - 13 IN - U5415-900	16	32541003	Wheel Shaft
	37253389	Hood - AG - 13 IN CP 25.0 - U5415-900	17	38521004	Front Wheel
	37253361	Hood - AAY - 13 IN - U5436-950	18	36131056	* Wheel Retainer
	37253373	Hood - ADS - 13 IN - U5439-900, U5437-960	19	40309034	Bottom Plate / Duct Cover - 15 IN Labyrinth design (See illustration)
	37253381	Hood - ACX - 13" - U5330-900		40309025	Bottom Plate / Duct Cover - 13 IN (Incl. it. 22)
	37253395	Hood - ACF - 13" - U5394-900		40309026	Bottom Plate / Duct Cover - 15 IN (Inc. item 22)
	37253396	Hood - ABY - 13 IN - U5399-900	20	38781053	* Agitator Pulley Seal
	37253286	Hood - ABY - 15 IN - U5445-900	21	48414115	Agitator Assem. Comp. - 15 IN
	37253289	Hood - AG - 15 IN - U5475-900 - (Early models w/ Standard Hood)		48414110	Agitator Assem. Comp. - 13 IN
	37253299	Hood - AG - 15 IN - U5475-900 - (Late models w/ Deluxe Hood)	22	40309034	Bottom Plate / Duct Cover - 15 IN Labyrinth design (See illustration)
	37253294	Hood - AG - 15 IN - U5443-900		40309025	Bottom Plate / Duct Cover - 13 IN (Incl. it. 19)
	37253297	Hood - ABY - 15 IN - U5451-900		40309026	Bottom Plate / Duct Cover - 15 IN (Incl. it. 19)
	37253298	Hood - AG - 15 IN - U5469-910	23	39511004	Litter Picker (2)
	37253305	Hood - ACL - 15 IN - U5397-900	24	21447121	+*Screw Self Tapping
	37253313	Hood - ACF - 15 IN - U5449-940	25	13261AY	* Rug Nozzle Rib Shoe
	37253316	Hood - AG - 15 IN - U5420-900	26	38528033	Belt
	37253306	Hood - ABR - 15 IN - U5396-900			
	37253319	Hood - MU - 15 IN - U5447-900			
	37253343	Hood - ADK - 15 IN - U5450-900			
	N/A	Hood - AAY - 15 IN - U5452-900			
	37253350	Hood - ADX - 15 IN - U5456-900, U5460-900			
	37253360	Hood - ADY - 15 IN - U5457-900			
	37253383	Hood - AFE - 15 IN - U5452-900 (Models produced after 5/01)			
	37253363	Hood - ACL - 15 IN - U5435-900			
	37253387	Hood - ABR - 15 IN - U5398-900			
	37253391	Hood - ADX - 15 IN - U5454-900, U5446-900,			
	37253388	Hood - AG - 15 IN - U5477-900			
2	43431005	Angled Hose Conn. Assem. w/ Hose Door (models w/o nozzle hose extension)			
3	38458043	Handle Release Lever			
4	40309004	Nozzle Adj. Lever / Cam Assembly (Inc. item 13)			
5	21447072	* Screw Self Tapping			
6	36131094	Trunnion Cover - ABE			
7	36171044	Hose Clamp - ABE			
8	160017	* Retaining Ring			
9	38522077	Rear Wheel			
	43244005	Rear Wheel - U5452-900			
10	32434008	Rear Axle - AAX			

* Model U5395-960 is identical to model U5395-900 except for addition of deluxe hose and nozzle hose extension.

** Model U5395-940 is identical to model U5395-900 except for additional 6 Throw-away bags.

*** Model U5443-940 and U5445-940 are identical to models U5443-940 and U5445-940 respectively except for additional 6 Throw-away bags.

**** Model U5443-960 is identical to model U5443-900 except for the addition of the extra 20' hose.

***** U5396-960 is identical to model U5396-900 except for the addition of the extra 20' hose.

***** Model U5475-960 is identical to model U5475-900 except for 31' cord and addition of 20' hose.

*****Model U5398-990 is identical to model U5398-900 except for the addition of a turbine powered hand tool.