

HOOVER Original

WINDTUNNEL

Models U5445-900, U5465-900, U5465-960

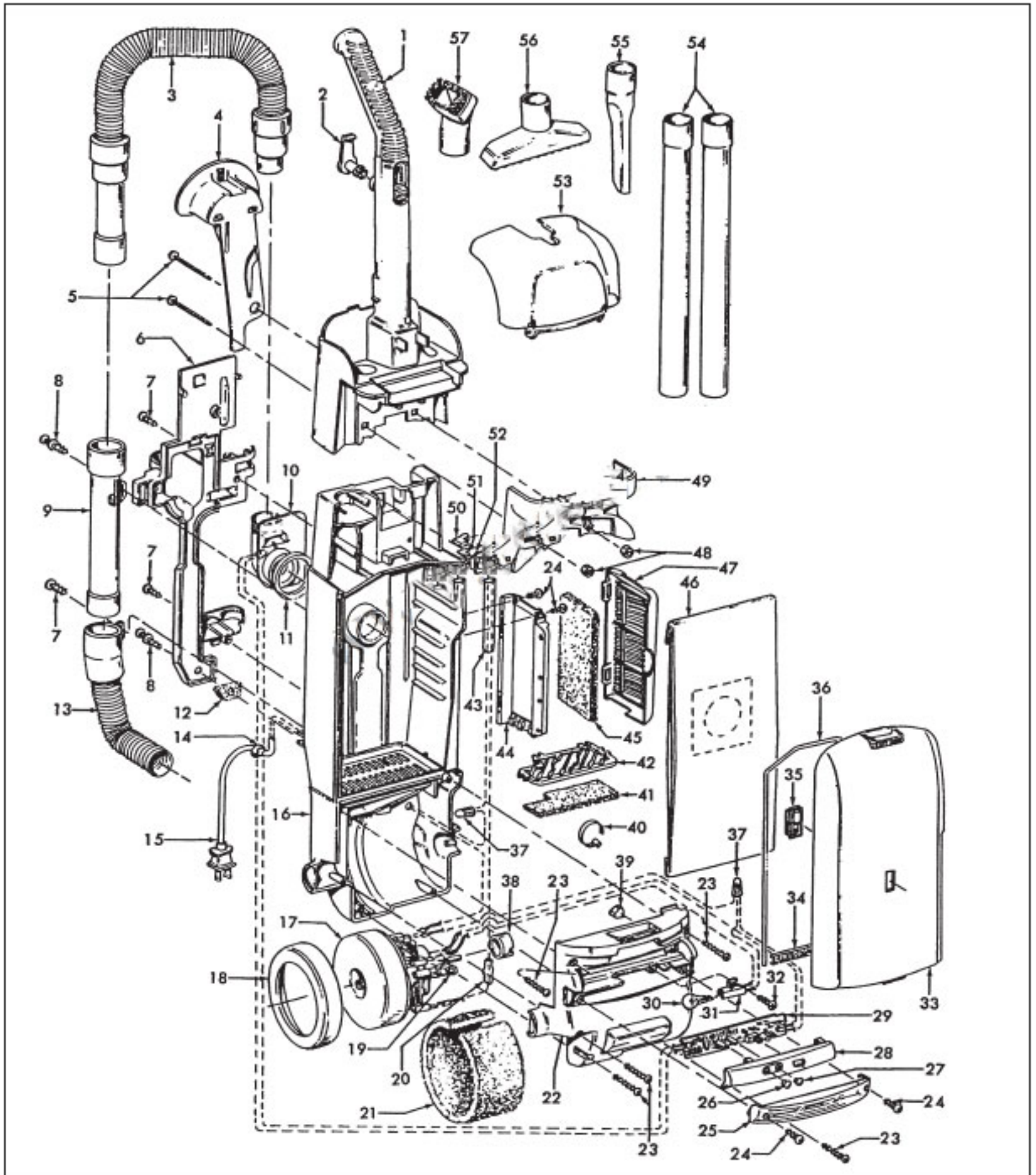

Original

HOOVER

WINDTUNNEL

Models U5445-900, U5465-900, U5465-960

KEY	PART NO.	DESCRIPTION
1	H-48663205	Upper Handle - ABE (Incl. Items 2, 49)
2	H-39442042	Cord Wrap
3	H-43434247	Hose Ass'y Comp.
4	H-36433111	Hose Holder - ABE
5	H-40201149	Handle Hardware
6	H-36433120	Wand/Hose Holder - ABE
7	H-21447242	Screw Self Tapping
8	H-23149002	Screw Self Tapping - U5465-900
9	H-38634007	Wand With Door - U5465-900
10	H-47823003	EDF Mic/Duct Ass'y
11	H-31178017	Hose Connector Gasket
12	H-34311004	Wire Opening Seal
13	H-43431215	Angled Hose Connection Ass'y
14	H-27482230	Strain Relief
15	H-46383322	Attachment Cord Ass'y - AG
16	H-37255011	Bag Housing - Deluxe - ABE
17	H-43576175	Motor Ass'y
18	H-36322035	Motor Mount - Large
19	H-41311017	Motor Brush Ass'y (2)
20	H-47534020	Thermal Protector Ass'y Comp.
21	N/A	Not Available
22	H-37196008	Motor Cover - ABE
23	H-21447230	Screw Self Tapping
24	H-21447228	Screw Self Tapping
25	H-39383107	Lens - CP
26	H-27352030	Snap-In Lens - Red
27	H-27352031	Snap-In Lens - Green
28	H-42258001	EDF Cover - ABE
29	H-46851031	EDF Printed Circuit Board Ass'y
30	H-27313101	Dirt Finder Lamp
31	H-47173017	Wiring Harness Ass'y
32	H-21447072	Screw Self Tapping
33	H-37254098	Bag Housing Door - Deluxe

KEY	PART NO.	DESCRIPTION
34	H-38781054	Bag Door Gasket
35	H-51151010	Indicator Ass'y
36	H-38781054	Bag Door Gasket
37	H-27618508	Wire Connector
38	H-36322030	Motor Mount - Small
39	H-34131019	Wire Opening Plug
40	H-27479307	Lead Wire Tie
41	H-38765019	Secondary Filter
42	H-36426034	Secondary Filter Retainer
43	H-66655409	Protector Tube
44	H-36426033	Filter Holder - ABE
45	H-38766007	Final Filter - U5445-900
45	H-38766009	Final Filter - U5465-900, U5465-960
46	H-4010100Y	Throw-Away Bag (3 Pk)
47	H-37257221	Filter Grill - ABC
48	H-40201149	Handle Hardware
49	N/A	Not Available
50	N/A	Not Available
51	N/A	Not Available
52	H-28161063	Switch
	H-40309033	Switch Kit
53	H-37257176	Tool Door - MN
54	H-38634078	Extension Tube - AG
55	H-38617027	Crevice Tool - ABR
56	H-38614037	Furniture Nozzle - ABR
57	H-43414162	Dusting Brush - ABR

Items Not Illustrated

H-43414142	Floor Brush Ass'y - AG - U5465-960
H-43434250	Hose Ass'y Comp. - (Extra)
H-57363003	Air Freshener Tab
H-51632003	Filter Door Label
H-51639143	Label Filter Door
H-51869050	Warning Label

Original

HOOVER

WINDTUNNEL

Models U5395-900 (13 in), U5433-900 (13 in),
Models U5445-900 (15 in), U5465-900 (15 in), U5465-960 (15 in)

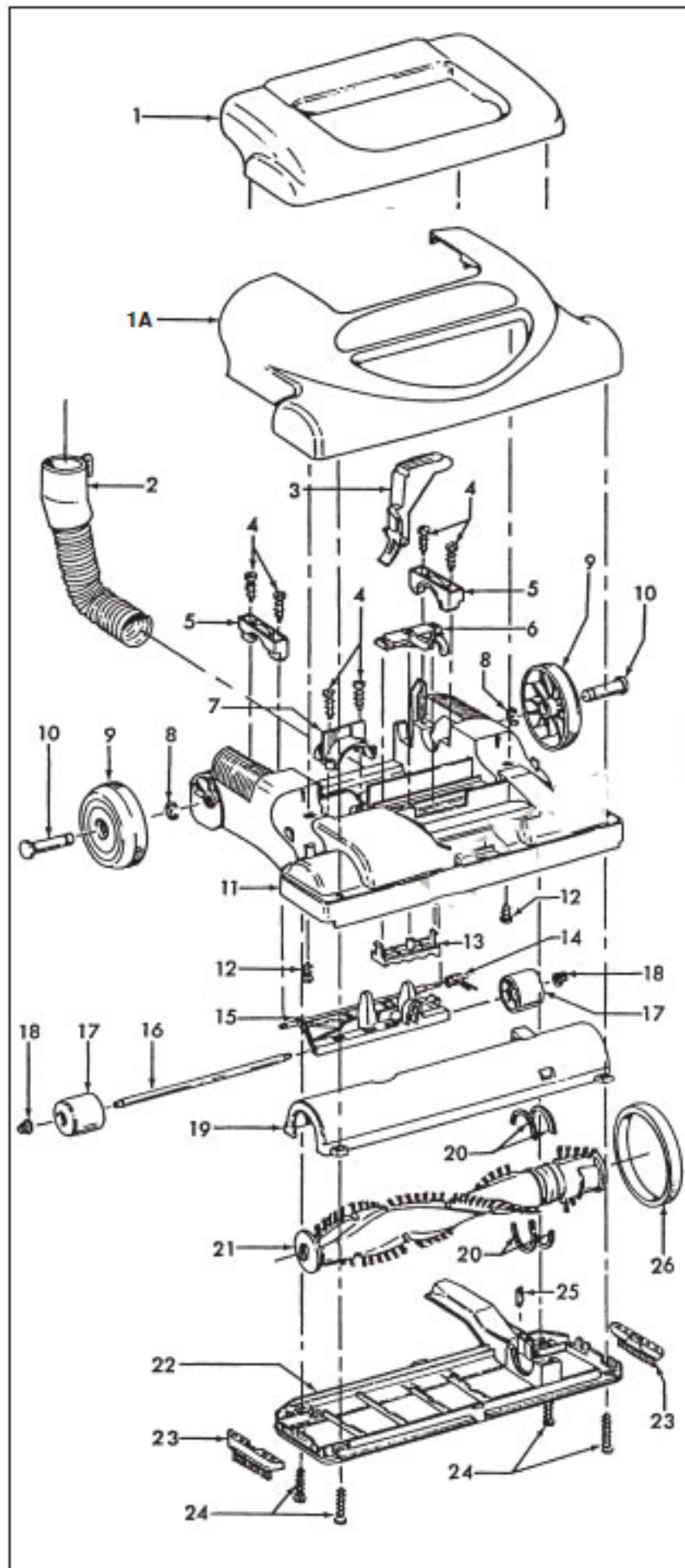

KEY	PART NO.	DESCRIPTION
1	H-37253285	Hood - ABY - 13 IN - U5433-900
1A	H-37253286	Hood - ABY - 15 IN - U5445-900
1	H-37253287	Hood - ABY - 13 IN - U5395-900
1A	H-37253284	Hood - ABY - Deluxe - 15 IN U5465-900, U5465-960
2	H-43431215	Angled Hose Conn. Ass'y
3	H-38458043	Handle Release Lever
4	H-21447072	Screw Self Tapping
5	H-36131094	Trunion Cover - ABE
6	H-38421087	Nozzle Adj. Lever - AG
7	H-36171044	Hose Clamp - ABE
8	H-160017	Retaining Ring
9	H-38522077	Rear Wheel
10	H-32434008	Rear Axle - AAX
11	H-37242124	Main Body - ABE - 13 IN
11	H-37242123	Main Body - ABE - 15 IN
12	H-21447228	Screw Self Tapping
13	H-38563007	Nozzle Adj. Cam - ABE
14	H-38355010	Torsion Spring
15	H-36432024	Front Wheel Support
16	H-32541003	Wheel Shaft
17	H-38521004	Front Wheel
	H-43248057	Front Wheel Ass'y (Incl. Keys 15, 16, 17, 18)
18	H-36131056	Wheel Retainer
19	H-37243023	Duct Cover & Bottom Plate - 13 IN
19	H-37243022	Duct Cover & Bottom Plate - 15 IN
20	H-38781053	Agitator Pulley Seal
21	H-48414062	Agitator Ass'y Comp. - 13 IN
21	H-48414017	Agitator Ass'y Comp. - 15 IN
22	N/A	Bottom Plate - 13 IN Order H-37243023
22	N/A	Bottom Plate - 15 IN Order H-37243022
23	H-39511004	Litter Picker
24	H-21447121	Screw Self Tapping
25	H-13261	Rug Nozzle Rib Shoe
26	H-38528033	Belt

N/A = Not Available