

This Owner's Manual is provided and hosted by [Appliance Factory Parts](#).

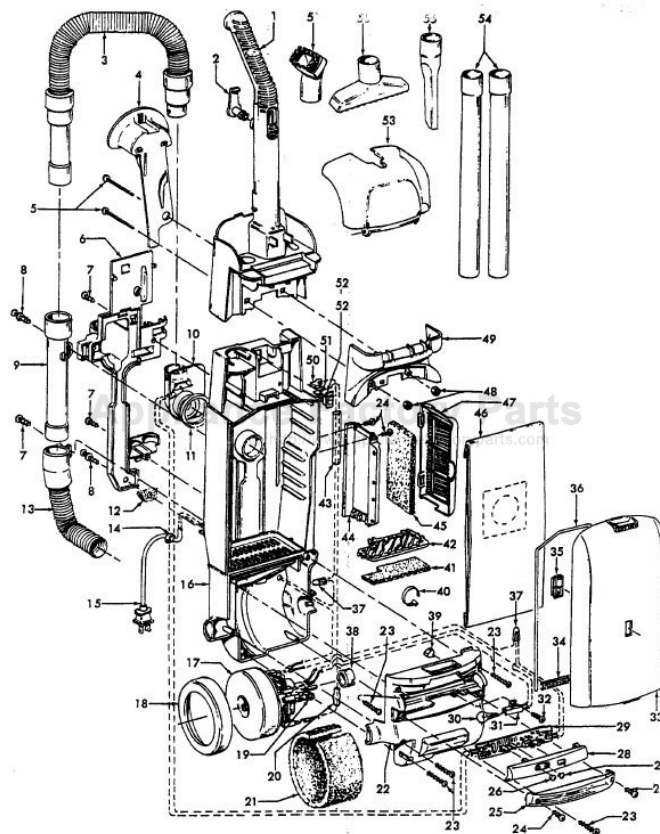

HOOVER U5456-900 Owner's Manual

[Shop genuine replacement parts for HOOVER
U5456-900](#)



[Find Your HOOVER Vacuum Cleaner Parts - Select From 1456 Models](#)

----- Manual continues below part list -----

Available Replacement Parts for HOOVER U5456-900

H-4010100Y	BAG VACUUM CLEANER OEM HOOVER 3 PACK
HR-1832	FILTER FOR VACUUM 2 pack
HR-2013	BRUSHROLLER 12.25 IN
HR-2015	ROLLER BRUSH ASSY
K-109289	BULB
FA-3035	ATTACHMENT CORD ASSY
H-43244005	Rear wheel
H-40110004	FOAM FILTER,2PK, READ EXT INFO
H-43248057	front wheel assy
H-38528033	BELT, FLAT, 1PK

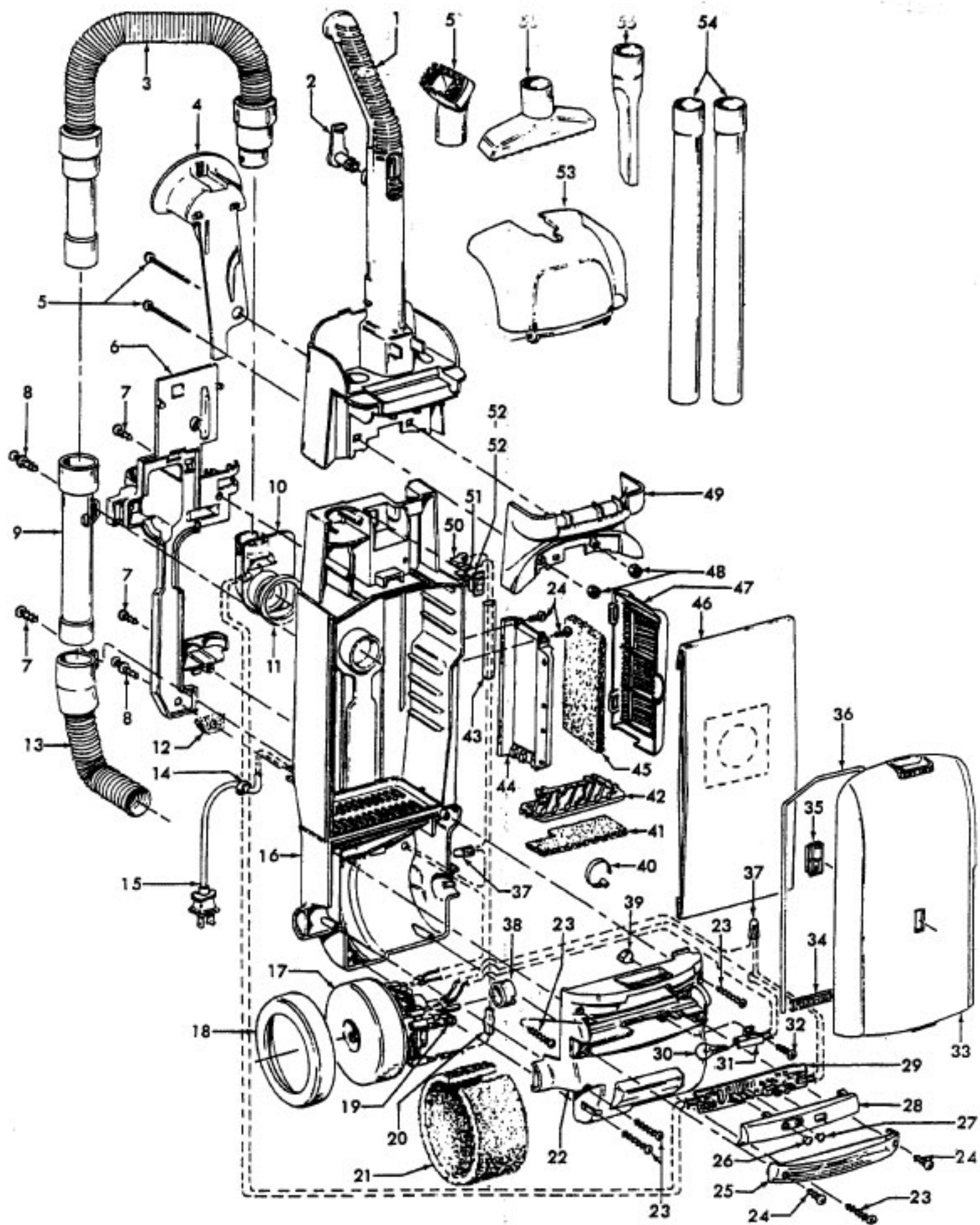

WindTunnel

Model U5439-900, U5452-900, U5453-900, U5454-900, U5456-900, U5458-900, U5462-900, U5464-900

Ref.	Part No.	Description	Ref.	Part	Description
1	48663205	Upper Handle - ABE (Inc. It. 2, 49)		42255103	Bag Hsg. Door - ADS - U5462-900,
2	3944201P	Cord Wrap		42255063	Bag Hsg. Door - ADX - U5454-900
3	43434031	Hose Assembly Comp.	34	34123050	Bag Door Gasket
4	36433137	Hose Holder	35	51151010	Indicator Assembly - U5453-900, U5454-900, U5458-900
5	40201149	Handle Hardware			Bag Door Gasket
6	36433120	Wand/Hose Holder - ABE	36	38781057	* Wire Connector
7	21447242	Screw Self Tapping	37	27618508	Motor Mount - Small
8	23149002	Screw	38	36322030	Wire Opening Plug
9	43457024	Hose Door Assembly	39	34131019	* Lead Wire Tie
10	47823003	EDF Mic / Duct Assembly	40	27479307	Secondary Filter
11	31178017	Hose Connector Gasket	41	38765019	Secondary Filter Retainer
12	34311004	Wire Opening Seal	42	38428034	Protector Tube
13	43431005	Angled Hose Connection Assembly	43	66655409	Filter Holder - ABE
14	27482230	Strain Relief	44	38428033	Final Filter - (Inc. 2 filters)
15	46383322	Cord - 35' - w/ 3/16" terminals	45	40110004	Throw-Away Bag (3 Pk)
	46383334	Cord - 35' - w/ 1/4" terminals (See note 1)	46	4010100Y	Filter Grill - ABC
16	40309040	Bag Housing - Dlx. - ABE	47	37257221	Handle Hardware
	37255029	Bag Housing - Dlx. - U5462-900 U5464-900	48	40201149	Not Available
17	43576188	Motor Assembly	49-51		Not Available
	43566016	Motor Suction Fan	52	N/A	Switch - 3/16" terminals(Use 40309033 Switch Kit)
	33426001	Fan Nut			Switch - 1/4" terminals (see note 1)
18	36322035	Motor Mount - Large	53	28161067	Tool Door - AAN
19	41311017	Motor Brush Assembly (2)	54	37257260	Extension Tube - AG
20	47534027	Thermal Protector - w/ 3/16" terminal	55	38634078	Crevice Tool - ABR
	28382087	Thermal Protector- w/ 1/4" terminal (see note 1)	56	38617027	Furniture Nozzle - ABR
	51873001	Thermal Protector Label	57	3861401E	Dusting Brush - ABR
21		Not Applicable	Items Not Illustrated		
22	37196009	Motor Cover		43434042	Hose Assem. Comp. - (Extra - 20')
	37196158	Motor Cover-U5454-900, U5458-900, U5462-900, U5464-900		49811072	Lead Wire - Blue (from cord to switch) - 1/4" terminals (see note 1)
23	21447230	* Screw Self Tapping		12910	Cord Clamp
24	21447228	* Screw Self Tapping		27352032	Snap in Lens - Amber - U5452-900
25	39383107	Lens - CP		37911080	Handle Cap
26	27352030	Snap-In Lens - Red		40200013	Turbine Driven Hand Tool - Sapphire (P.357) U5454-900, U5456-900, U5458-900, U5462-900, U5464-900
27	27352031	Snap-In Lens - Green		56511A90	Owner Manual - U5452-900
28	42258002	EDF Cover - U5452-900		56511A67	Owner Manual - U5439-900, U5454-900, U5453-900, U5456-900, U5458-900
	42258001	EDF Cover - U5439-900, U5453-900, U5454-900, U5456-900, U5458-900, U5462-900, U5464-900		56511A96	Owner Manual - U5462-900 U5464-900
29	46851032	EDF PC Board - U5452-900		58185185	Cleaner Carton - U5452-900
	46851031	EDF PC Board - (see note 2) U5439-900, U5453-900, U5454-900, U5456-900, U5458-900, U5462-900, U5464-900		58185212	+ Cleaner Carton - U5439-900, U5453-900, U5454-900, U5456-900, U5462-900
30	27313101	Dirt Finder Lamp	Main body and related components:		
31	47173024	Wiring Harness - w/ 3/16" terminals	U5439-900, U5452-900, U5454-900, U5456-900 (P.325)		
	47173028	Wiring Harness - w/ 1/4" terminals (see note 1)	U5453-900, U5462-900, U5464-900 (P.329)		
32	21447072	* Screw Self Tapping	Note 1 - Models produced after June 2000 incorporated 14 gauge wiring and associated electrical components with 1/4" terminals. Ref. service bulletin 4-00. U5439-900 and U5456-900 were produced with 1/4" components only.		
33	Note: All Bag Hsg. Doors Include Items 34 & 36		Note 2 - Some models produced after January 2003 incorporated the 46851032 board with the amber light blacked out and pressure tube omitted.		
	42255087	Bag Hsg. Door - Common			
	42255098	Bag Hsg. Door - ADK - U5456-900, U5458-900			
	42255099	Bag Hsg. Door - ADS - U5439-900			
	42255102	Bag Hsg. Door - AFE - U5452-900			
	42255098	Bag Hsg. Door - ADK - U5453-900 U5464-900			

WindTunnel Models U5330-900 (15"), U5393-900(13"), U5394-900(13"), U5395-900(13"), ** U5395-940(13"), * U5395-960 (13"), U5395-970(13"), U5396-900(15"), ***** U5396-960 (15"), U5397-900(15"), U5398-900 (15"), *****U5398-990 (15 IN), U5399-900 (13 IN), U5403-900 (13"), U5433-900(13"), U5434-900(13"), U5435-900(13"), U5437-960, U5443-900(15"), U5439-900(13"), ***U5443-940(15"), ****U5443-960(15"), U5445-900(15"), *** U5445-940(15"), U5446-900, U5447-900 (15"), U5449-940 (15"), U5450-900 (15"), U5451-900(15"), U5454-900 (15"), U5456-900 (15"), U5457-900(15"), U5460-900 (15")

WT TurboPOWER Model U5415-900 (13"), U5420-900(15"), U5469-900(13"), U5469-910(15"), U5475-900(15")***** U5475-960 (15"), U5477-900 (15")

WT Farrington Model U5436-950, U5452-900 (15")

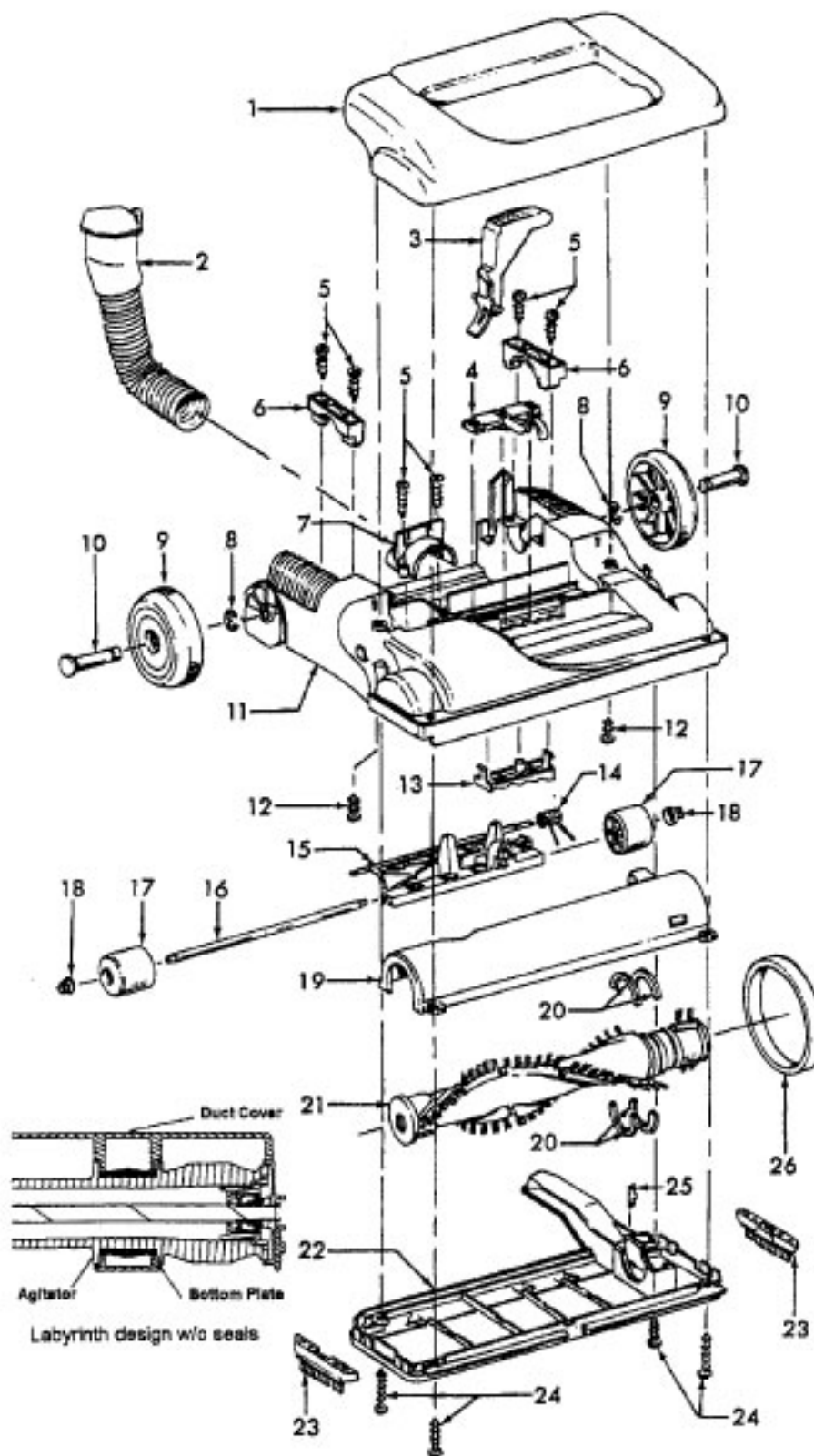

WindTunnel Models U5330-900 (15"), U5393-900(13"), U5394-900(13"), U5395-900(13"), ** U5395-940(13"), * U5395-960 (13"), U5395-970(13"), U5396-900(15"), ***** U5396-960 (15"), U5397-900(15"), U5398-900 (15"), *****U5398-990 (15 IN), U5399-900 (13 IN), U5403-900 (13"), U5433-900(13"), U5434-900(13"), U5435-900(13"), U5437-960, U5443-900(15"), U5439-900(13"), ***U5443-940(15"), ****U5443-960(15"), U5445-900(15"), *** U5445-940(15"), U5446-900, U5447-900 (15"), U5449-940 (15"), U5450-900 (15"), U5451-900(15"), U5454-900 (15"), U5456-900 (15"), U5457-900(15"), U5460-900 (15")

WT TurboPOWER Model U5415-900 (13"), U5420-900(15"), U5469-900(13"), U5469-910(15"), U5475-900(15")***** U5475-960 (15"), U5477-900 (15")

WT Farrington Model U5436-950, U5452-900 (15")

Ref. No.	Part No.	Description	Ref. No.	Part No.	Description
1	37253285	Hood - ABY - 13 IN - U5433-900	11	37242124	Main Body - ABE - 13 IN
	37253287	Hood - ABY - 13 IN - U5395-900		37242123	Main Body - ABE - 15 IN
	37253290	Hood - AG - 13 IN - U5469-900	12	21447228	* Screw Self Tapping
	37253307	Hood - ACM - 13 IN - U5403-900	13	40309004	Nozzle Adj. Lever / Cam Assembly (Inc. item 4)
	37253315	Hood - AG - 13 IN - U5393-900	14	38355010	Torsion Spring
	37253342	Hood - ADX - 13 IN - U5434-900	15	43248057	Front Wheel Assem. (Inc items 15, 16, 17, 18)
	37253353	Hood - AG - 13 IN - U5415-900	16	32541003	Wheel Shaft
	37253389	Hood - AG - 13 IN CP 25.0 - U5415-900	17	38521004	Front Wheel
	37253361	Hood - AAY - 13 IN - U5436-950	18	36131056	* Wheel Retainer
	37253373	Hood - ADS - 13 IN - U5439-900, U5437-960	19	40309034	Bottom Plate / Duct Cover - 15 IN Labyrinth design (See Illustration)
	37253381	Hood - ACX - 13" - U5330-900		40309025	Bottom Plate / Duct Cover - 13 IN (Incl. it. 22)
	37253395	Hood - ACF - 13" - U5394-900		40309026	Bottom Plate / Duct Cover - 15 IN (Inc. item 22)
	37253396	Hood - ABY - 13 IN - U5399-900	20	38781053	* Agitator Pulley Seal
	37253286	Hood - ABY - 15 IN - U5445-900	21	48414115	Agitator Assem. Comp. - 15 IN
	37253289	Hood - AG - 15 IN - U5475-900 - (Early models w/ Standard Hood)		48414110	Agitator Assem. Comp. - 13 IN
	37253299	Hood - AG - 15 IN - U5475-900 - (Late models w/ Deluxe Hood)	22	40309034	Bottom Plate / Duct Cover - 15 IN Labyrinth design (See Illustration)
	37253294	Hood - AG - 15 IN - U5443-900		40309025	Bottom Plate / Duct Cover - 13 IN (Incl. it. 19)
	37253297	Hood - ABY - 15 IN - U5451-900		40309026	Bottom Plate / Duct Cover - 15 IN (Incl. it. 19)
	37253298	Hood - AG - 15 IN - U5469-910	23	39511004	Litter Picker (2)
	37253305	Hood - ACL - 15 IN - U5397-900	24	21447121	+*Screw Self Tapping
	37253313	Hood - ACF - 15 IN - U5449-940	25	13261AY	* Rug Nozzle Rib Shoe
	37253316	Hood - AG - 15 IN - U5420-900	26	38528033	Belt
	37253306	Hood - ABR - 15 IN - U5396-900			
	37253319	Hood - MU - 15 IN - U5447-900			
	37253343	Hood - ADK - 15 IN - U5450-900			
	N/A	Hood - AAY - 15 IN - U5452-900			
	37253350	Hood - ADX - 15 IN - U5456-900, U5460-900			
	37253360	Hood - ADY - 15 IN - U5457-900			
	37253383	Hood - AFE - 15 IN - U5452-900 (Models produced after 5/01)			
	37253363	Hood - ACL - 15 IN - U5435-900			
	37253387	Hood - ABR - 15 IN - U5398-900			
	37253391	Hood - ADX - 15 IN - U5454-900, U5446-900,			
	37253388	Hood - AG - 15 IN - U5477-900			
2	43431005	Angled Hose Conn. Assem. w/ Hose Door (models w/o nozzle hose extension)			
3	38458043	Handle Release Lever			
4	40309004	Nozzle Adj. Lever / Cam Assembly (Inc. item 13)			
5	21447072	* Screw Self Tapping			
6	36131094	Trunnion Cover - ABE			
7	36171044	Hose Clamp - ABE			
8	160017	* Retaining Ring			
9	38522077	Rear Wheel			
	43244005	Rear Wheel - U5452-900			
10	32434008	Rear Axle - AAX			

* Model U5395-960 is identical to model U5395-900 except for addition of deluxe hose and nozzle hose extension.

** Model U5395-940 is identical to model U5395-900 except for additional 6 Throw-away bags.

*** Model U5443-940 and U5445-940 are identical to models U5443-940 and U5445-940 respectively except for additional 6 Throw-away bags.

**** Model U5443-960 is identical to model U5443-900 except for the addition of the extra 20' hose.

***** U5396-960 is identical to model U5396-900 except for the addition of the extra 20' hose.

***** Model U5475-960 is identical to model U5475-900 except for 31' cord and addition of 20' hose.

*****Model U5398-990 is identical to model U5398-900 except for the addition of a turbine powered hand tool.