

This Owner's Manual is provided and hosted by [Appliance Factory Parts](#).



HOOVER U5477-900 Owner's Manual

[Shop genuine replacement parts for HOOVER
U5477-900](#)



[Find Your HOOVER Vacuum Cleaner Parts - Select From 1456 Models](#)

----- Manual continues below part list -----

Available Replacement Parts for HOOVER U5477-900

H-4010100Y	BAG VACUUM CLEANER OEM HOOVER 3 PACK
HR-1832	FILTER FOR VACUUM 2 pack
HR-2013	BRUSHROLLER 12.25 IN
HR-2015	ROLLER BRUSH ASSY
K-109289	BULB
FA-3035	ATTACHMENT CORD ASSY
H-36426034	Secondary filter retainer.
H-43244005	Rear wheel
H-40110004	FOAM FILTER,2PK, READ EXT INFO
H-43248057	front wheel assy
H-38528033	BELT, FLAT, 1PK

WindTunnel

Models U5443-900, * U5443-940, ** U5443-960, U5445-900,
* U5445-940, U5447-900, U5449-940, U5450-900, U5451-900, U5460-900
U5461-900, U5463-960, U5465-900, U5465-960, U5465-970, ****U5465-990
U5457-900

WindTunnel TurboPOWER 6200

Model U5475-900, U5475-960, U5477-900

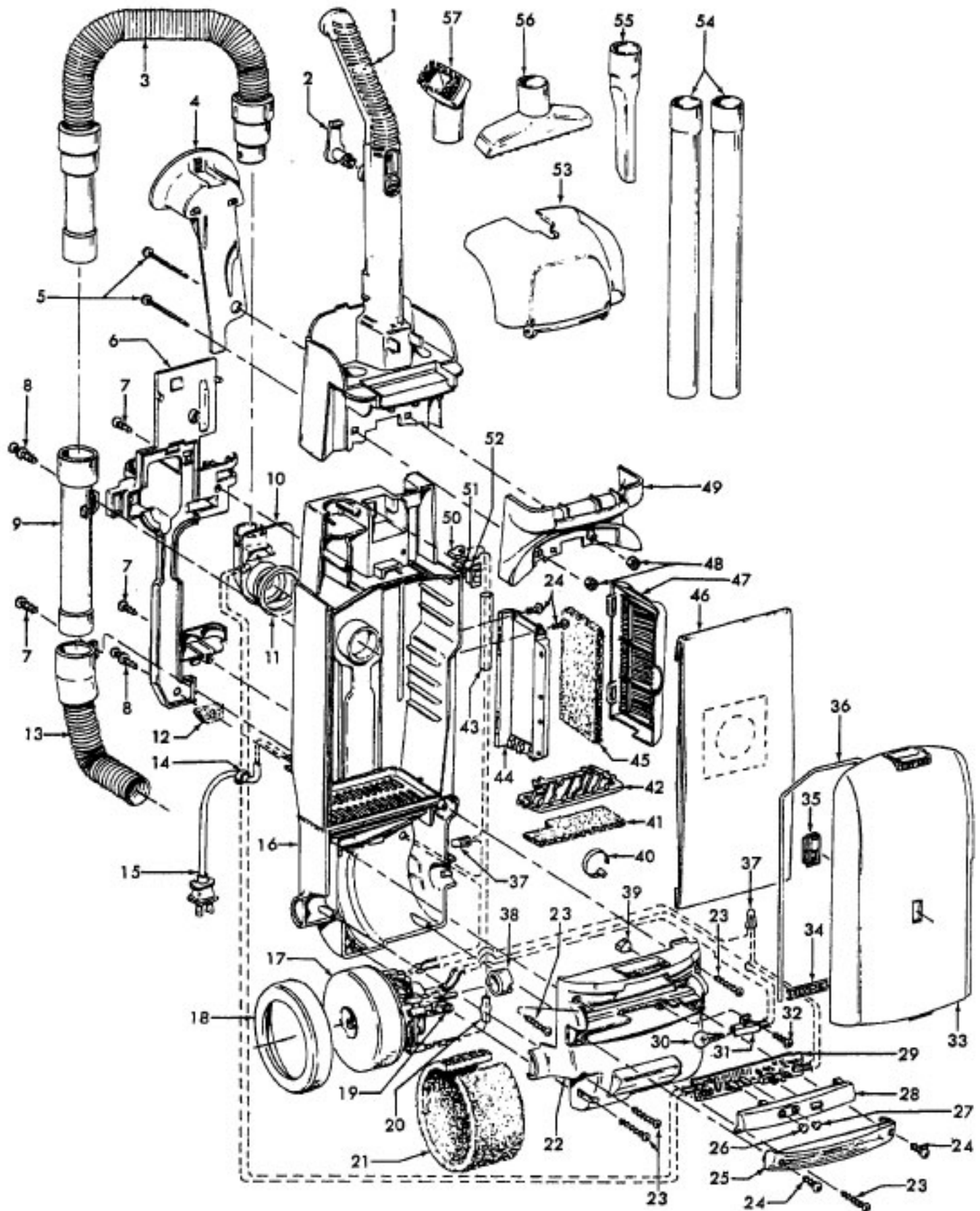

WindTunnel

Models U5443-900, * U5443-940, ** U5443-960, U5445-900,
 * U5445-940, U5447-900, U5449-940, U5450-900, U5451-900, U5460-900
 U5461-900, U5463-960, U5465-900, U5465-960, U5465-970, ****U5465-990
 U5457-900, U5477-900

Ref. No.	Part No.	Description	Ref. No.	Part No.	Description
1	48663205	Upper Handle - ABE (Inc. lt. 2, 49)	40	27479307	* Lead Wire Tie
2	3944201P	Cord Wrap	41	38765019	Secondary Filter
3	43434031	Hose Assembly Comp.	42	36426034	Secondary Filter Retainer
4	36433111	+ Hose Holder - Early Models	43	66655409	Protector Tube
	36433137	Hose Holder - Late Models - see note # 1	44	36425033	Filter Holder - ABE
5	40201149	Handle Hardware	45	38766007	Final Filter - 2 layer - U5443-900, U5445-900, U5449-940, U5460-900
6	36433120	Wand/Hose Holder - ABE		40110004	Final Filter - 3 layer - (Inc. two filters)
7	21447242	Screw Self Tapping	46	4010100Y	Throw-Away Bag (3 Pk)
8	23149002	Screw - U5463-960, U5465-900	47	37257221	Filter Grill - ABC
9	43457024	Hose Door Assembly	48	40201149	Handle Hardware
10	47823003	EDF Mic / Duct Assembly	49 - 51		Not Available
11	31178017	Hose Connector Gasket	52	28161063	Switch - 3/16" Terminals
12	34311004	Wire Opening Seal		28161067	Switch - 1/4" Terminals
13	43431005	Angled Hose Connection Assem.	53	37257260	Tool Door - AAN
14	27482230	Strain Relief	54	38634078	Extension Tube - AG
15	46383322	Cord - 35' - 3/16" Terminal	55	38617027	Crevice Tool - ABR
	46383334	Cord - 35' - 1/4" Terminal (See note 3)	56	3861401E	Furniture Nozzle - ABR
16	40309040	Bag Housing - Dlx. - ABE	57	43414162	Dusting Brush - ABR
	37255029	Bag Housing - Dlx. - ABE- U5477-900			
17	43576188	Motor Assembly		Items Not Illustrated	
	43568016	Motor Suction Fan		49129010	Turbine Hand Tool - U5460-900, U5457-900 (P-357)
	33426001	Fan Nut			Floor Brush - AG - U5465-960, U5475-900
18	36322035	Motor Mount - Large		43414142	Hose Assem. Comp. - (Extra) , U5461-900
19	41311017	Motor Brush Assembly (2)		43434042	U5465-900, U5465-960, U5475-900 - (See Note 2), U5443-960, U5449-940, U5460-900, U5475-960
20	47534027	Thermal Protector - 3/16" Terminal			Air Freshener Tab - U5465-960
	28382067	Thermal Prot. - 1/4" Terminal (See note 3)		57363003	Cord Clamp
	51873001	Thermal Protector Label		12910	+ Filter Door Label
21		Not Applicable		51632003	Label Filter Door
22	37196009	Motor Cover		51639143	Warning Label
	37196158	Motor Cover - U5477-900		51869050	Snap in Lens - Amber
23	21447230	* Screw Self Tapping		27352032	Lead Wire Blue - (From cord to switch)
24	21447228	* Screw Self Tapping		49811058	Owners Manual - U5460-900
25	39383107	Lens - CP		56511A96	Owners Manual
26	27352030	Snap-In Lens - Red		56511A35	Owners Manual - U5475-900 (after 07/23/99)
27	27352031	Snap-In Lens - Green		56511A73	Owner Manual - U5461-900, U5447-900, U5450-900, U5457-900
28	42258001	EDF Cover - models w/ red and green light		56511A90	Owner Manual - U5477-900
	42258002	EDF Cover - models w/ red, green and amber light		58185185	Cleaner Carton - U5443-900, U5445-900, U5465-900, U5465-970, U5449-940
29	46851031	EDF PCB - w/ red and green lights		58185212	+ Cleaner Carton - U5461-900, U5447-900, U5450-900, U5460-900, U5457-900
	46851032	EDF PCB - w/ red, green, and amber lights		N/A	Cleaner Carton - U5465-960, U5475-900
30	27313101	Dirt Finder Lamp			* Model U5443-940 and U5445-940 are identical to models U5443-940 and U5445-900 respectively except for an additional 6 Throw-away bags.
31	47173024	Wiring Harness - 3/16" Terminals			** Model U5443-960 is identical to model U5443-900 except for the addition of a 20' hose.
	47173028	Wiring Harm. - 1/4" Terminals (See note 3)			*** Model U5475-960 is identical to model U5475-900 except for 31' cord and addition of a 20' hose.
32	21447072	* Screw Self Tapping			****Model U5465-990 is a bonus pack which includes a U5465-900 plus six additional Y bags, one additional final filter, and two extra belts.
33	These bag doors include items 34 & 36				Note #1 - The late model tool holder was revised by adding supporting ribs to the hooks. To use the late model tool holder on an early model unit requires a new tool door. Ref: Service Bulletin 2-99
	42255033	Bag Door - ABY - U5445-900, U5451-900, U5465-900, U5465-960 (Also Inc. item 35)			Note #2 - The extra hose assembly is not packed with models U5475-900 produced after 07/23/99.
	42255063	Bag Door - ADX - U5461-900, U5463-900			Note #3 - Models produced after June 2000 incorporated 14 gauge wiring and associated electrical components with 1/4" terminals. Ref. Service Bulletin 4-00
	42255053	Bag Door - ABY - Common - U5443-900, U5465-970, U5475-970			
	42255082	Bag Door - ACF - U5449-940			
	42255088	Bag Door - MU - U5447-900			
	42255098	Bag Door - ADK - U5450-900			
	42255096	Bag Door - Dk. Spruce - U5457-900			
	42255100	Bag Door - ADX - U5460-900 (Models after June 2001)			
	Models with Amber performance light - no bag check ind.				
	42255092	Bag Door - ADX - U5460-900 (Models before June 2001)			
	42255087	Bag Door - ABY - U5451-900, U5465-900			
	42255075	Bag Door - ABY - U5445-900			
	42255086	Bag Door - AG - U5475-900			
	42255108	Bag Door - AG - U5477-900			
34	34123050	Bag Door Gasket			
35	51151010	Indicator Assem. (Early Models)			
36	38781057	Bag Door Gasket			
37	27618508	* Wire Connector			
38	36322030	Motor Mount - Small			
39	34131019	Wire Opening Plug			

WindTunnel Models U5330-900 (15"), U5393-900(13"), U5394-900(13"), U5395-900(13"), ** U5395-940(13"),
 * U5395-960 (13"), U5395-970(13"), U5396-900(15"), ***** U5396-960 (15"), U5397-900(15"),
 U5398-900 (15"), *****U5398-990 (15 IN), U5399-900 (13 IN), U5403-900 (13"), U5433-900(13"),
 U5434-900(13"), U5435-900(13"), U5437-960, U5443-900(15"), U5439-900(13"), ***U5443-940(15"),
 ****U5443-960(15"), U5445-900(15"), *** U5445-940(15"), U5446-900, U5447-900 (15"),
 U5449-940 (15"), U5450-900 (15"), U5451-900(15"), U5454-900 (15"), U5456-900 (15"), U5457-900(15"),
 U5460-900 (15")

WT TurboPOWER Model U5415-900 (13"), U5420-900(15"), U5469-900(13"), U5469-910(15"), U5475-900(15")*****
 U5475-960 (15"), U5477-900 (15")

WT Farrington Model U5436-950, U5452-900 (15")

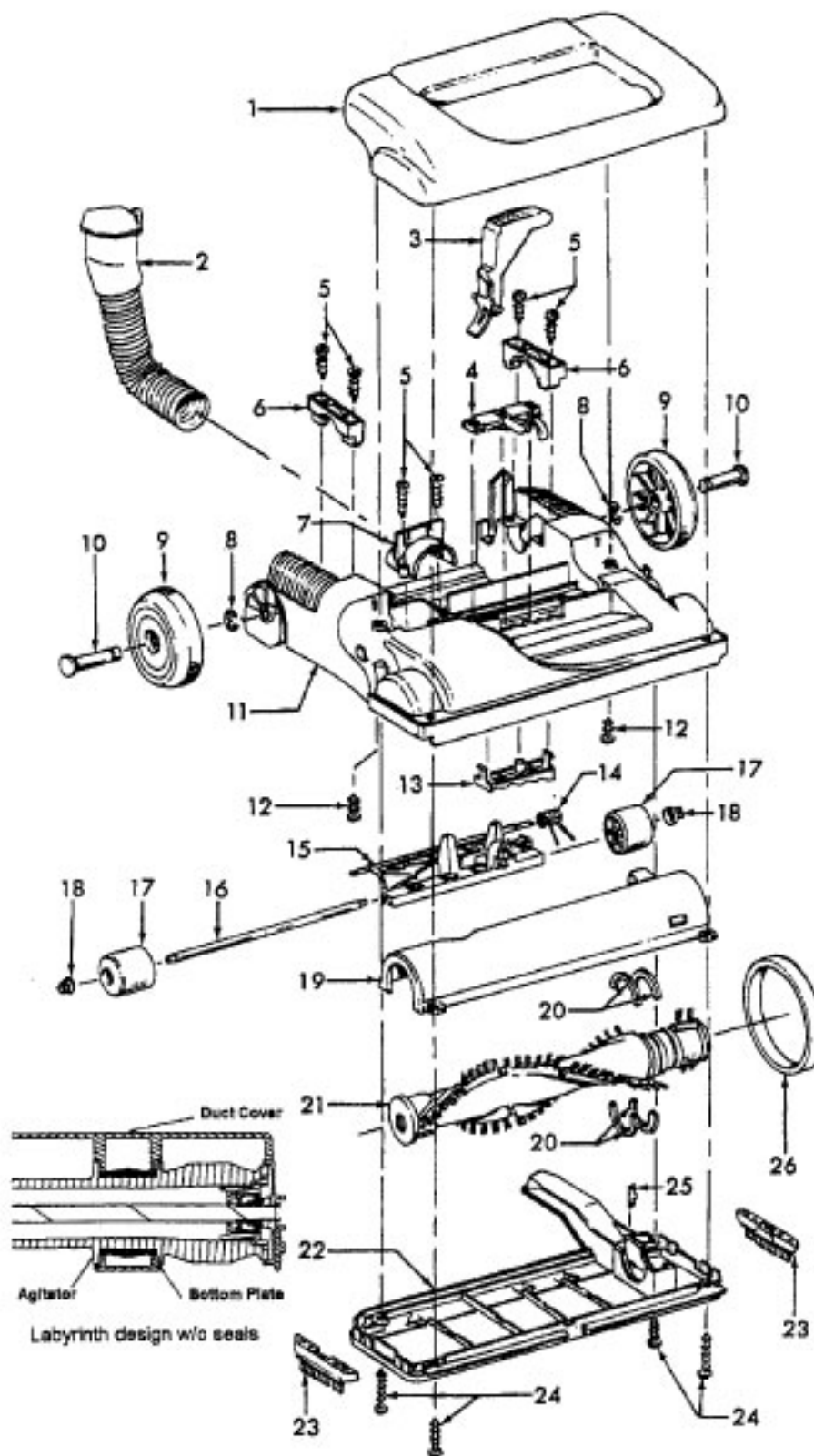

WindTunnel Models U5330-900 (15"), U5393-900(13"), U5394-900(13"), U5395-900(13"), ** U5395-940(13"), * U5395-960 (13"), U5395-970(13"), U5396-900(15"), ***** U5396-960 (15"), U5397-900(15"), U5398-900 (15"), *****U5398-990 (15 IN), U5399-900 (13 IN), U5403-900 (13"), U5433-900(13"), U5434-900(13"), U5435-900(13"), U5437-960, U5443-900(15"), U5439-900(13"), ***U5443-940(15"), ****U5443-960(15"), U5445-900(15"), *** U5445-940(15"), U5446-900, U5447-900 (15"), U5449-940 (15"), U5450-900 (15"), U5451-900(15"), U5454-900 (15"), U5456-900 (15"), U5457-900(15"), U5460-900 (15")

WT TurboPOWER Model U5415-900 (13"), U5420-900(15"), U5469-900(13"), U5469-910(15"), U5475-900(15")***** U5475-960 (15"), U5477-900 (15")

WT Farrington Model U5436-950, U5452-900 (15")

Ref. No.	Part No.	Description
1	37253285	Hood - ABY - 13 IN - U5433-900
	37253287	Hood - ABY - 13 IN - U5395-900
	37253290	Hood - AG - 13 IN - U5469-900
	37253307	Hood - ACM - 13 IN - U5403-900
	37253315	Hood - AG - 13 IN - U5393-900
	37253342	Hood - ADX - 13 IN - U5434-900
	37253353	Hood - AG - 13 IN - U5415-900
	37253389	Hood - AG - 13 IN CP 25.0 - U5415-900
	37253361	Hood - AAY - 13 IN - U5436-950
	37253373	Hood - ADS - 13 IN - U5439-900, U5437-960
	37253381	Hood - ACX - 13" - U5330-900
	37253395	Hood - ACF - 13" - U5394-900
	37253396	Hood - ABY - 13 IN - U5399-900
	37253286	Hood - ABY - 15 IN - U5445-900
	37253289	Hood - AG - 15 IN - U5475-900 - (Early models w/ Standard Hood)
	37253299	Hood - AG - 15 IN - U5475-900 - (Late models w/ Deluxe Hood)
	37253294	Hood - AG - 15 IN - U5443-900
	37253297	Hood - ABY - 15 IN - U5451-900
	37253298	Hood - AG - 15 IN - U5469-910
	37253305	Hood - ACL - 15 IN - U5397-900
	37253313	Hood - ACF - 15 IN - U5449-940
	37253316	Hood - AG - 15 IN - U5420-900
	37253306	Hood - ABR - 15 IN - U5396-900
	37253319	Hood - MU - 15 IN - U5447-900
	37253343	Hood - ADK - 15 IN - U5450-900
	N/A	Hood - AAY - 15 IN - U5452-900
	37253350	Hood - ADX - 15 IN - U5456-900, U5460-900
	37253360	Hood - ADY - 15 IN - U5457-900
	37253383	Hood - AFE - 15 IN - U5452-900 (Models produced after 5/01)
	37253363	Hood - ACL - 15 IN - U5435-900
	37253387	Hood - ABR - 15 IN - U5398-900
	37253391	Hood - ADX - 15 IN - U5454-900, U5446-900,
	37253388	Hood - AG - 15 IN - U5477-900
2	43431005	Angled Hose Conn. Assem. w/ Hose Door (models w/o nozzle hose extension)
3	38458043	Handle Release Lever
4	40309004	Nozzle Adj. Lever / Cam Assembly (Inc. item 13)
5	21447072	* Screw Self Tapping
6	36131094	Trunnion Cover - ABE
7	36171044	Hose Clamp - ABE
8	160017	* Retaining Ring
9	38522077	Rear Wheel
	43244005	Rear Wheel - U5452-900
10	32434008	Rear Axle - AAX

Ref. No.	Part No.	Description
11	37242124	Main Body - ABE - 13 IN
	37242123	Main Body - ABE - 15 IN
12	21447228	* Screw Self Tapping
13	40309004	Nozzle Adj. Lever / Cam Assembly (Inc. item 4)
14	38355010	Torsion Spring
15	43248057	Front Wheel Assem. (Inc items 15, 16, 17, 18)
16	32541003	Wheel Shaft
17	38521004	Front Wheel
18	36131056	* Wheel Retainer
19	40309034	Bottom Plate / Duct Cover - 15 IN Labyrinth design (See illustration)
	40309025	Bottom Plate / Duct Cover - 13 IN (Incl. It. 22)
	40309026	Bottom Plate / Duct Cover - 15 IN (Inc. item 22)
20	38781053	* Agitator Pulley Seal
21	48414115	Agitator Assem. Comp. - 15 IN
	48414110	Agitator Assem. Comp. - 13 IN
22	40309034	Bottom Plate / Duct Cover - 15 IN Labyrinth design (See illustration)
	40309025	Bottom Plate / Duct Cover - 13 IN (Incl. it. 19)
	40309026	Bottom Plate / Duct Cover - 15 IN (Incl. It. 19)
23	39511004	Litter Picker (2)
24	21447121	+*Screw Self Tapping
25	13261AY	* Rug Nozzle Rib Shoe
26	38528033	Belt

* Model U5395-960 is identical to model U5395-900 except for addition of deluxe hose and nozzle hose extension.

** Model U5395-940 is identical to model U5395-900 except for additional 6 Throw-away bags.

*** Model U5443-940 and U5445-940 are identical to models U5443-940 and U5445-940 respectively except for additional 6 Throw-away bags.

**** Model U5443-960 is identical to model U5443-900 except for the addition of the extra 20' hose.

***** U5396-960 is identical to model U5396-900 except for the addition of the extra 20' hose.

***** Model U5475-960 is identical to model U5475-900 except for 31' cord and addition of 20' hose.

*****Model U5398-990 is identical to model U5398-900 except for the addition of a turbine powered hand tool.