

This Owner's Manual is provided and hosted by [Appliance Factory Parts](#).



HOOVER U5491-950 Owner's Manual

[Shop genuine replacement parts for HOOVER
U5491-950](#)



[Find Your HOOVER Vacuum Cleaner Parts - Select From 1455 Models](#)

----- Manual continues below -----



WINDTUNNELTM

S U P R E M E

ASSEMBLY SCHEMATIC

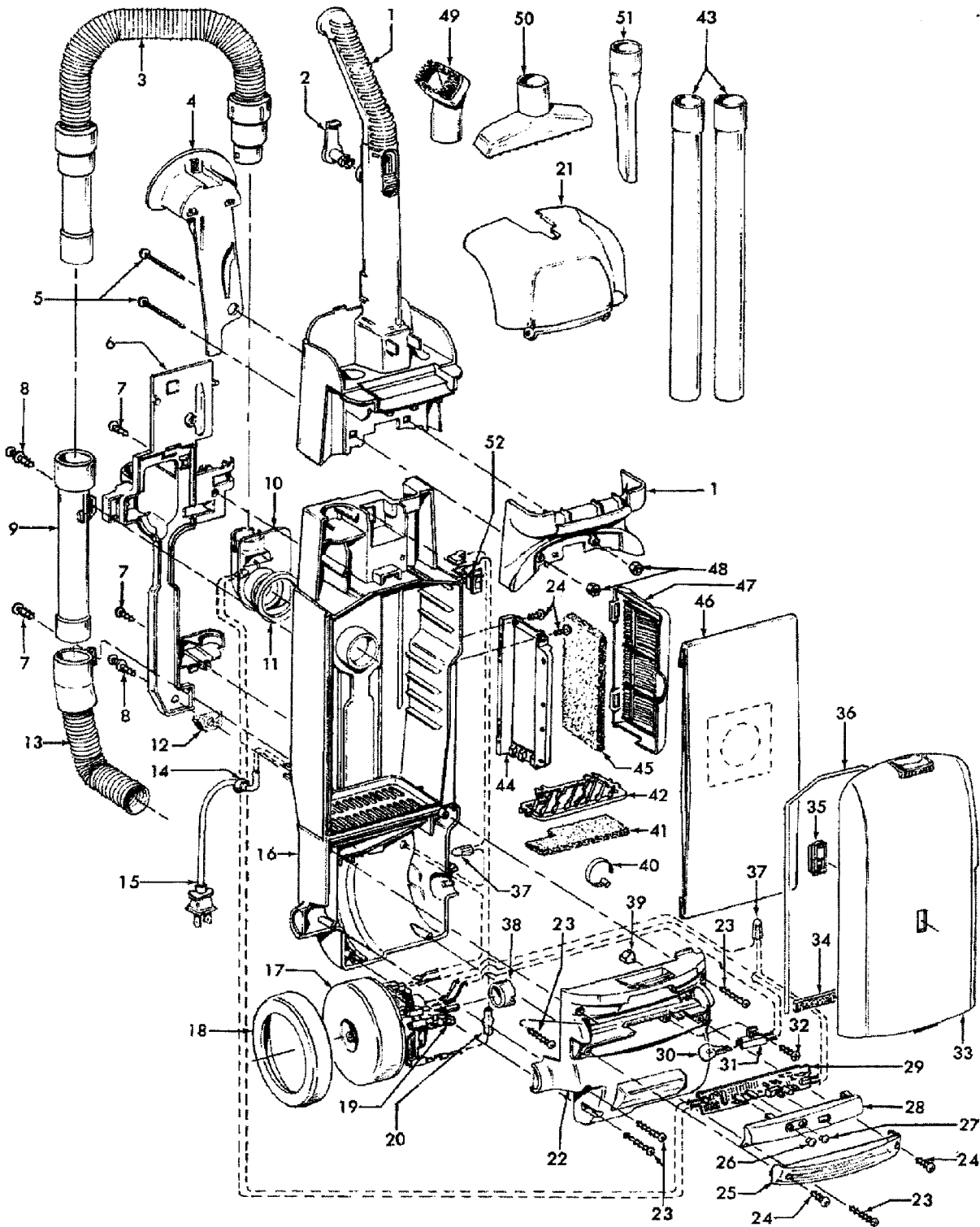

- U5458-900
- U5458-910
- U5460-900
- U5462-900
- U5467-900
- U5468-900
- U5470-900
- U5471-900
- U5472-900
- U5473-900
- U5481-900
- U5491-900
- U5491-950



WINDTUNNEL™

S U P R E M E

PART LISTING

ITEM	PART NUMBER	MODELS TO FIT	PART DESCRIPTION
1	H-37911080	ALL	HANDLE CAP / DELUXE - DARK CHARCOAL GRAY
	H-48663205	ALL	UPPER HANDLE COMPLETE - DARK CHARCOAL GRAY
	H-39466123	U5491900, U5491950	UPPER HANDLE COMPLETE - D - STYLE HANDLE
2	H-39442048	ALL	CORD WRAP - MAGNESIUM GRAY
	H-39442056	ALL	CORD WRAP - BLACK
3	H-43434031	ALL	HOSE ASSEMBLY COMPLETE
4	H-36433137	ALL	HOSE HOLDER - DARK CHARCOAL GRAY
5	H-40201149	ALL	HANDLE HARDWARE ASSEMBLY
6	H-36433120	ALL	WAND/HOSE HOLDER - DARK CHARCOAL GRAY
7	H-21447242	ALL	SCREW - SELF TAPPING
8	H-23149002	ALL	SCREW - SELF TAPPING
9	H-43457024	ALL	HOSE DOOR ASSEMBLY
10	H-47823003	ALL	EDF MICRO/DUCT ASSEMBLY
11	H-31178017	ALL	HOSE CONNECTOR GASKET
12	H-34311004	ALL	WIRE OPENING SEAL
13	H-43431005	ALL	HOSE DOOR ASSEMBLY
14	H-27482230	ALL	STRAIN RELIEF
15	H-46383334	ALL	CORD - 35'
16	H-92001023	ALL	BAG HOUSING DELUXE - DARK CHARCOAL GRAY
	H-40309040	ALL	BAG HOUSING KIT - DLX INCL MOTOR HOUSING
17	H-27212057	ALL	MOTOR ASSEMBLY COMPLETE
	H-33426001	ALL	NUT
	H-90001206	ALL	FAN ASSEMBLY
18	H-36322037	ALL	MOTOR MOUNT - LARGE
19	H-41311017	ALL	MOTOR BRUSH
20	H-47534027	U5462900	THERMAL PROTECTOR - 3/16
	H-28382087	ALL	THERMAL PROTECTOR - .250
21	H-37257260	ALL	TOOL DOOR
22	H-37196009	U5491900, U5491950	MOTOR COVER - BLACK
	H-37196158	ALL	MOTOR COVER - DARK CHARCOAL GRAY
23	H-21447230	ALL	SCREW - SELF TAPPING
24	H-21447228	ALL	SCREW - SELF TAPPING
25	H-39383107	ALL	LENS

MODEL No.

U5458-900
 U5458-910
 U5460-900
 U5462-900
 U5467-900
 U5468-900
 U5470-900
 U5471-900
 U5472-900
 U5473-900
 U5481-900
 U5491-900
 U5491-950



WINDTUNNEL™

S U P R E M E

PART LISTING

ITEM	PART NUMBER	MODELS TO FIT	PART DESCRIPTION
26	H-27352030	ALL	SNAP IN LENS - RED
27	H-27352031	ALL	SNAP IN LENS - GREEN
28	H-42258001	ALL EXCEPT U5460900, U5462900	EDF COVER / 2 LIGHTS - DARK CHARCOAL GRAY
	H-42258003	U5491900, U5491950	EDF COVER / 2 LIGHTS
	H-42258002	U5460900, U5462900	EDF COVER / 3 LIGHTS - DARK CHARCOAL GRAY
29	H-46851083	ALL EXCEPT U5460900, U5462900	EDF PRINTED CIRCUIT BOARD / 2 LIGHTS
	H-46851032	U5460900, U5462900	EDF PRINTED CIRCUIT BOARD / 3 LIGHTS
30	H-27313101	ALL	LAMP / LIGHT BULB
31	H-47173028	U5460900, U5462900	WIRING HARNESS - RIGHT FLAG TERMINAL
	H-47173027	ALL EXCEPT U5460900, U5462900	WIRING HARNESS - STRAIGHT TERMINAL
32	H-21447072	ALL	SCREW
33	N.A.	U5458900, U5458910, U5460900	BAG HOUSING DOOR DELUXE INCL #34 & #36 - SAPPHIRE TRANSPARENT
	N.A.	U5462900, U5467900	BAG HOUSING DOOR DELUXE INCL #34 & #36 - SILVER QUARTZ METALLIC
	N.A.	U5460900	BAG HOUSING DOOR DELUXE INCL #34 & #36 - DARK SPRUCE TRANSPARENT
	H-92001091	U5470900, U5481900	BAG HOUSING DOOR DELUXE INCL #34 & #36 - SAGE GREEN METALLIC
	H-37254287	U5471900	BAG HOUSING DOOR DELUXE INCL #34 & #36 - LEGACY PURPLE
	H-37254288	U5472900	BAG HOUSING DOOR DELUXE INCL #34 & #36 - SILVER QUARTZ METALLIC
	H-37254285	U5473900	BAG HOUSING DOOR DELUXE INCL #34 & #36 - CATALINA BLUE
	H-37254283	U5491900, U5491950	BAG HOUSING DOOR DELUXE INCL #34 & #36 - TECHNO BLUE METALLIC
34	H-34123050	ALL	BAG DOOR GASKET - BOTTOM
35	H-51151010	ALL	BAG INDICATOR
36	H-38781057	ALL	BAG DOOR GASKET - 34.5"
37	H-27618508	ALL	WIRE CONNECTOR
38	H-36322030	ALL	MOTOR MOUNT - SMALL
39	H-34131019	ALL	WIRE OPENING PLUG
40	H-27479307	ALL	CABLE TIE
41	H-38765019	ALL	SECONDARY FILTER

MODEL NO.

U5458-900
 U5458-910
 U5460-900
 U5462-900
 U5467-900
 U5468-900
 U5470-900
 U5471-900
 U5472-900
 U5473-900
 U5481-900
 U5491-900
 U5491-950



WINDTUNNEL™

S U P R E M E

PART LISTING

ITEM	PART NUMBER	MODELS TO FIT	PART DESCRIPTION
42	H-36426034	ALL	SECONDARY FILTER RETAINER
43	H-38634078	ALL	EXTENSION TUBE - BLACK
44	H-36426033	ALL	FILTER HOLDER - DARK CHARCOAL GRAY
45	H-40110004	ALL	FINAL FILTER - 2 PACK
46	H-4010100Y	ALL	TYPE Y BAG / ALLERGEN - 3 PACK
	H-4010801Y	ALL	TYPE Y BAG / HEPA - 2 PACK
47	H-37257221	ALL	FILTER GRILL - DARK CHARCOAL GRAY
	H-37257323	U5491900, U5491950	FILTER GRILL ASSEMBLY
48	H-40201149	ALL	HANDLE HARDWARE ASSEMBLY
49	H-43414197	ALL	DUSTING BRUSH ASSEMBLY - BLACK
50	H-38614044	ALL	FURNITURE NOZZLE - GRAPHITE GRAY
	H-38614045	ALL	FURNITURE NOZZLE - BLACK
51	H-38617033	ALL	CREVICE TOOL - SHORT BLACK
	H-38617031	ALL	CREVICE TOOL - LONG GRAPHITE GRAY
52	H-28161067	ALL	SWITCH - .025 TERMINAL
53	H-49129032	ALL	TURBINE HAND TOOL
	H-49124044	ALL	TURBINE HAND TOOL
54	H-92001259	U5491900, U5491950	12" FLOOR BRUSH ASSEMBLY - BLACK
	H-43434042	ALL	EXTRA HOSE ASSEMBLY - OPTIONAL

MODEL NO.

U5458-900
 U5458-910
 U5460-900
 U5462-900
 U5467-900
 U5468-900
 U5470-900
 U5471-900
 U5472-900
 U5473-900
 U5481-900
 U5491-900
 U5491-950



WINDTUNNEL[™]

S U P R E M E

ASSEMBLY SCHEMATIC

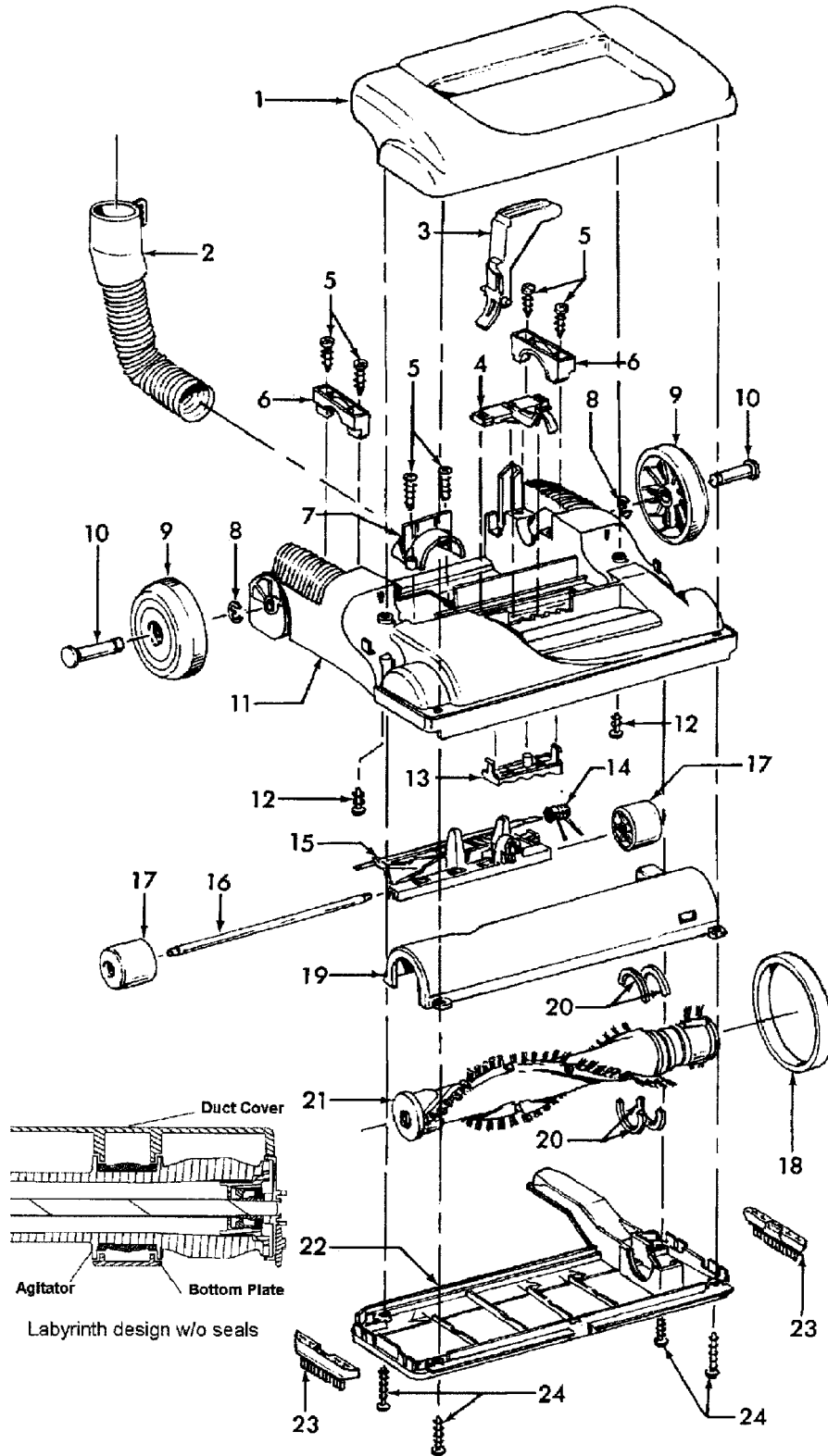

MODEL NO.

- U5458-900
- U5458-910
- U5460-900
- U5462-900
- U5467-900
- U5468-900
- U5470-900
- U5471-900
- U5472-900
- U5473-900
- U5481-900
- U5491-900
- U5491-950



WINDTUNNEL™

S U P R E M E

PART LISTING

ITEM	PART NUMBER	MODELS To FIT	PART DESCRIPTION
1	H-92001090	U5470900, U5481900	HOOD - SAGE GREEN METALLIC
	H-91001069	U5467900	HOOD - LACQUER RED METALLIC
	H-37253364	U5458900, U5458910, U5460900	HOOD - SAPPHIRE TRANSPARENT
	H-37253386	U5462900	HOOD - RUBY TRANSPARENT
	H-37253448	U5471900	HOOD - LEGACY PURPLE
	H-37253A75	U5472900	HOOD - SILVER QUARTZ METALLIC
	H-37253A78	U5473900	HOOD - CATALINA BLUE
	H-42252B75	U5491900, U5491950	HOOD - TECHNO BLUE METALLIC
2	H-43431005	ALL	HOSE DOOR ASSEMBLY
3	H-38458043	ALL	HANDLE RELEASE LEVER - BLACK
	H-38434049	U5491900, U5491950	HANDLE RELEASE LEVER - SONIC SILVER
4	H-40309004	ALL	NOZZLE ADJUST LEVER / CAM KIT
5	H-21447072	ALL	SCREW
6	H-36131094	ALL	TRUNNION COVER - DARK CHARCOAL GRAY
7	H-36171044	ALL	HOSE CLAMP - DARK CHARCOAL GRAY
8	H-160017	ALL	LOCK RING
9	H-38522077	ALL	REAR WHEEL
	H-43247033	U5491900, U5491950	REAR WHEEL ASSEMBLY
10	H-32434007	ALL	REAR AXLE
11	H-37242135	ALL	MAIN BODY w / FURNITURE GUARD
	H-37242158	U5491900, U5491950	MAIN BODY w / FURNITURE GUARD
12	H-21447228	ALL	SCREW - SELF TAPPING
13	H-40309004	ALL	NOZZLE ADJUST LEVER / CAM KIT
14	H-38355010	ALL	TORSION SPRING
15	H-36432027	ALL	FRONT WHEEL SUPPORT - CLEAR
	H-43248064	ALL	FRONT WHEEL ASSEMBLY COMPLETE
	H-43248075	U5491900, U5491950	FRONT WHEEL ASSEMBLY COMPLETE
16	H-32541003	U5460900, U5462900	WHEEL SHAFT - ZINC PLATE COATED
	H-32541007	ALL	WHEEL SHAFT - ZINC PLATE COATED
17	H-38521009	ALL	FRONT WHEEL - BLACK
	H-38522105	U5491900, U5491950	FRONT WHEEL - BLACK SOFT TREAD
18	H-38528033	ALL	BELT
	H-40201160	ALL	BELT - 2 PACK

MODEL No.

U5458-900
 U5458-910
 U5460-900
 U5462-900
 U5467-900
 U5468-900
 U5470-900
 U5471-900
 U5472-900
 U5473-900
 U5481-900
 U5491-900
 U5491-950



WINDTUNNEL™

S U P R E M E

PART LISTING

ITEM	PART NUMBER	MODELS TO FIT	PART DESCRIPTION
19	H-40309026	ALL	BOTTOM PLATE / DUCT 15"
20	H-38781053	ALL	BRUSH ROLL / AGITATOR PULLEY SEAL
21	H-48414132	ALL	BRUSH ROLL / AGITATOR 15"
22	H-40309026	ALL	BOTTOM PLATE / DUCT 15"
23	H-39511004	ALL	LITTER PICKER / EDGE GROOMER
	H-39511018	ALL	LITTER PICKER / EDGE GROOMER - BLACK
24	H-21447121	ALL	SCREW

U5458-900
U5458-910
U5460-900
U5462-900
U5467-900
U5468-900
U5470-900
U5471-900
U5472-900
U5473-900
U5481-900
U5491-900
U5491-950