

This Owner's Manual is provided and hosted by [Appliance Factory Parts](#).



HOOVER UH40265 Owner's Manual

[Shop genuine replacement parts for HOOVER UH40265](#)



[Find Your HOOVER Vacuum Cleaner Parts - Select From 1455 Models](#)

----- Manual continues below -----

WINDTUNNEL™ BAGLESS

ASSEMBLY SCHEMATIC

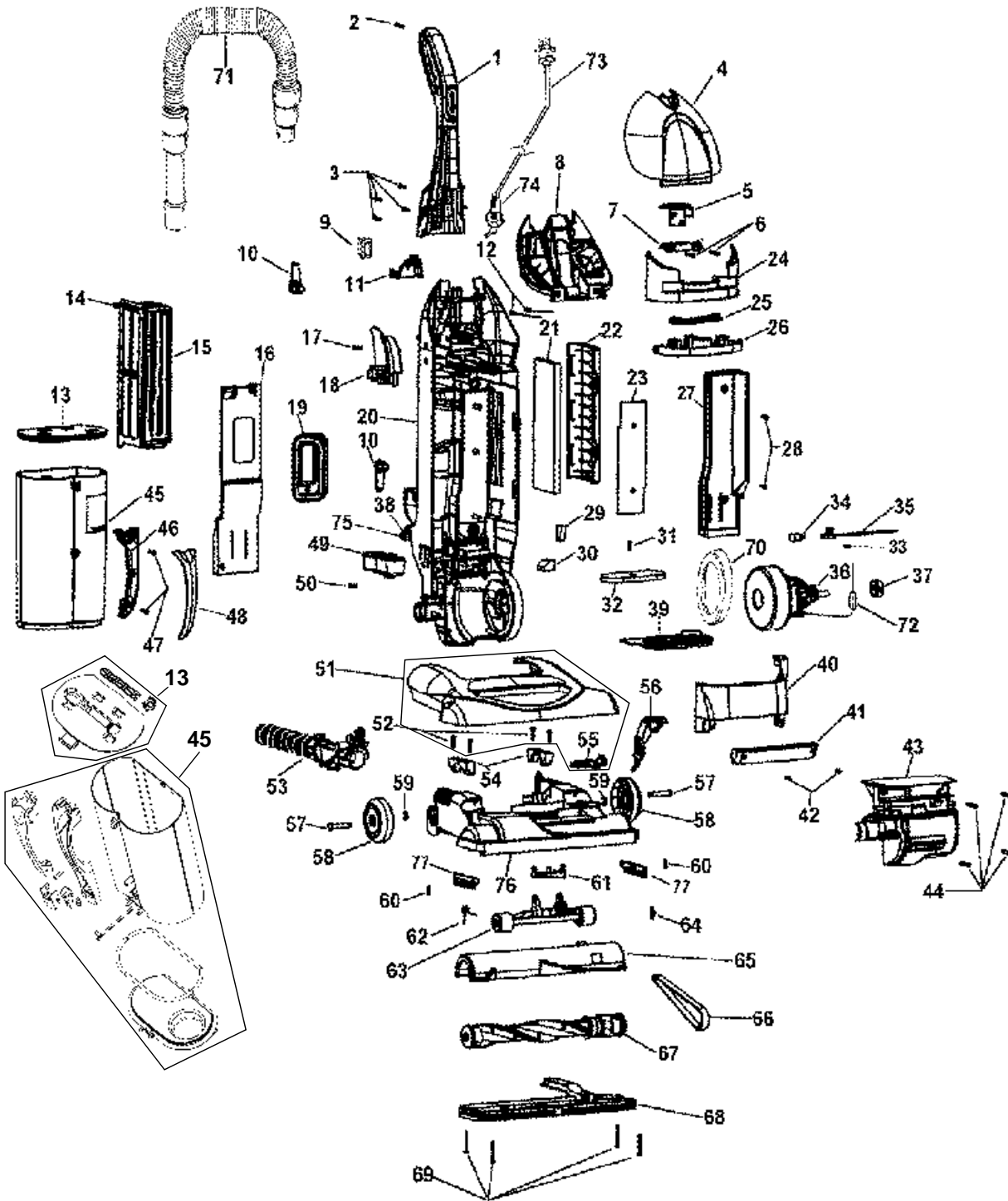

U5762-900
UH40020
UH40065
UH40145B
UH40265

WINDTUNNEL™ BAGLESS

PART LISTING

ITEM	PART NUMBER	MODELS TO FIT	PART DESCRIPTION
1	H-39466088	ALL	UPPER HANDLE ASSEMBLY - DARK CHARCOAL GRAY
2	H-21447236	ALL	SCREW
3	H-21447072	ALL	SCREW
4	H-37257263	U5762900	TOOL DOOR WITH LOGO
	H-37257305	ALL	TOOL DOOR WITH LOGO
5	H-92001088	ALL	DIRT CUP LID LATCH - BLACK
6	H-21447242	ALL	SCREW - SELF TAPPING
7	H-36155013	ALL	DIRT CUP LID LATCH HOLDER - DARK CHARCOAL GRAY
8	H-36433149	U5762900	TOOL HOLDER
	H-36433146	ALL	TOOL HOLDER - DARK CHARCOAL GRAY
9	H-28161067	ALL	SWITCH
10	H-39442048	ALL	CORD WRAP - MAGNESIUM GRAY
11	H-36923004	ALL	SWITCH SUPPORT - DARK CHARCOAL GRAY
12	H-21447246	ALL	SCREW
13	H-37249042	U5762900	DIRT CUP LID - DARK CHARCOAL GRAY
	H-42249015	UH40020, UH40125, UH40145B, UH40265	DIRT CUP LID ASSEMBLY
14	H-92001025	U5762900	PRE-FILTER SUPPORT ASSEMBLY
	H-36426099	UH40020, UH40125, UH40145B, UH40265	PRE-FILTER SUPPORT ASSEMBLY
15	H-40140201	ALL	CARTRIDGE FILTER
16	H-37258121	ALL	WIRE CHANNEL COVER - DARK CHARCOAL GRAY
17	H-21447242	ALL	SCREW - SELF TAPPING
18	H-36433148	ALL	UPPER WAND/HOSE HOLDER - DARK CHARCOAL GRAY
19	H-38783027	ALL	DIRT CUP INLET SEAL - BLACK
20	H-42259027	ALL	BACK HOUSING ASSEMBLY - DARK CHARCOAL GRAY
	H-37255015	ALL	REAR MUFFLER COVER - DARK CHARCOAL GRAY
21	H-40110006	ALL	FINAL / EXHAUST FILTER - 2 PK
	H-38766030	ALL	FINAL / EXHAUST FILTER WITH SLIT - 1 EA
22	H-37257289	ALL	FINAL / EXHAUST FILTER DOOR - MIST GRAY TRANSPARENT
23		ALL	FOAM - MUFFLER FILTER

U5762-900
UH40020
UH40065
UH40145B
UH40265

WINDTUNNEL™ BAGLESS

PART LISTING

ITEM	PART NUMBER	MODELS TO FIT	PART DESCRIPTION
24	H-37258166	U5762900	DIRT CUP LATCH COVER SHROUD - PEWTER METALLIC
	H-38258215	UH40020, UH40265	DIRT CUP LATCH COVER SHROUD - BRONZE
	H-37258218	UH40065	DIRT CUP LATCH COVER SHROUD - EASY BLUE
	H-37258224	UH40145B	DIRT CUP LATCH COVER SHROUD - CRIMSON PENDING
25	H-37258206	ALL	CAM SLOT CAP - SILVER
26	H-38567062	ALL	DIRT CUP LATCH COVER
27	H-37259016	ALL	MUFFLER FILTER COVER - DARK CHARCOAL GRAY
28	H-21447242	ALL	SCREW - SELF TAPPING
29	H-34131009	ALL	WIRE CHANNEL FOAM
30	H-34131019	ALL	WIRE OPENING PLUG
31	H-21447242	ALL	SCREW - SELF TAPPING
32	H-38762008	ALL	SECONDARY / INLET FILTER
33	H-21447072	ALL	SCREW
34	H-27313101	ALL	LAMP - LIGHT BULB
35	H-47173027	ALL	WIRING HARNESS
36	H-27212057	ALL	MOTOR ASSEMBLY COMPLETE
	H-49811079	ALL	LEAD WIRE - WHITE 12 AMP
37	H-36322030	ALL	MOTOR MOUNT - SMALL
38	H-21447242	ALL	SCREW - SELF TAPPING
39	H-43615088	ALL	SECONDARY / INLET FILTER RETAINER
40	H-37944023	U5762900	CIRCUIT BOARD COVER - SILVER QUARTZ
	H-37944037	UH40020, UH40265	CIRCUIT BOARD COVER - BRONZE
	H-37944039	UH40065	CIRCUIT BOARD COVER - EASY BLUE
	H-37944043	UH40145B	CIRCUIT BOARD COVER - RED
41	H-39383107	ALL	LENS
42	H-21447228	ALL	SCREW - SELF TAPPING
43	H-37196160	ALL	MOTOR COVER
44	H-21447230	ALL	SCREW - SELF TAPPING
45	H-38775077	U5762900	DIRT CUP
	H-42254195	UH40020, UH40125, UH40145B, UH40265	COMPLETE DIRT CUP ASSEMBLY
46	H-39457018	U5762900	DIRT CUP HANDLE - INNER
		UH40020, UH40125, UH40145B, UH40265	DIRT CUP HANDLE - ORDER #45

U5762-900
UH40020
UH40065
UH40145B
UH40265

WINDTUNNEL™ BAGLESS

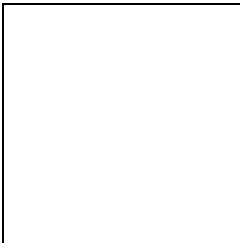

PART LISTING

ITEM	PART NUMBER	MODELS TO FIT	PART DESCRIPTION
47	H-21447043	ALL	SCREW - SELF TAPPING
48	H-39457033	U5762900	DIRT CUP HANDLE COVER
		UH40020, UH40125, UH40145B, UH40265	DIRT CUP HANDLE COVER - ORDER #45
49	H-36433147	ALL	LOWER WAND HOLDER - DARK CHARCOAL GRAY
50	H-21447242	ALL	SCREW - SELF TAPPING
51	H-37253390	U5762900	HOOD / NOZZLE COVER - BLACK
	H-42252B78	UH40020, UH40265	HOOD / NOZZLE COVER - BRONZE
	H-42252B75	UH40065	HOOD / NOZZLE COVER - EASY BLUE
	H-42252B81	UH40145B	HOOD / NOZZLE COVER - CRIMSON
52	H-21447072	ALL	SCREW
53	H-43516010	ALL	LOWER HOSE / VALVE ASSEMBLY
54	H-36131094	ALL	TRUNNION COVER
55	H-40309004	ALL	HEIGHT ADJUSTMENT LEVER AND CAM
56	H-38458043	ALL	HANDLE RELEASE LEVER
57	H-32434007	ALL	REAR AXEL
58	H-38522077	U5762900	REAR WHEEL
	H-43247033	UH40020, UH40125, UH40145B, UH40265	REAR WHEEL ASSEMBLY
59	H-160017--	ALL	LOCK RING
60	H-21447228	ALL	SCREW - SELF TAPPING
61	H-40309004	ALL	HEIGHT ADJUSTMENT LEVER AND CAM
62	H-38355010	ALL	TORSION SPRING
63	H-43248064	U5762900	FRONT WHEEL ASSEMBLY COMPLETE
	H-43248075	UH40020, UH40125, UH40145B, UH40265	FRONT WHEEL ASSEMBLY COMPLETE
64	H-013261AY	ALL	RIB SHOES
65	H-40309026	ALL	BOTTOM PLATE DUCT AND NOZZLE GUARD
66	H-38528033	ALL	FLAT BELT
	H-40201160	ALL	FLAT BELT - 2 PACK
67	H-48414132	ALL	AGITATOR / BRUSH ROLL - 15" WOODEN
68	ORDER #65	ALL	BOTTOM PLATE DUCT AND NOZZLE GUARD
69	H-21447121	ALL	SCREW
70	H-36322037	ALL	MOTOR MOUNT - LARGE
71	H-43491087	ALL	HOSE ASSEMBLY
72	H-28382093	ALL	THERMAL PROTECTOR

U5762-900
UH40020
UH40065
UH40145B
UH40265

WINDTUNNEL™ BAGLESS

PART LISTING

ITEM	PART NUMBER	MODELS To FIT	PART DESCRIPTION
73	H-46383334	ALL	POWER CORD - 35'
74	H-36215028	ALL	CORD PROTECTOR
75	H-36171035	ALL	HOSE CLAMP
76	H-37242135	ALL	MAIN BODY / NOZZLE BASE
77	H-39511018	ALL	LITTER PICKER - BLACK
78	H-43486010	U5762900	DIRT DUCT TUBE
	H-43486019	UH40020, UH40125, UH40145B, UH40265	DIRT DUCT TUBE
	H-38614044	U5762900	FURNITURE NOZZLE - GRAPHITE GRAY
	H-92001196	UH40020, UH40125, UH40145B, UH40265	FURNITURE NOZZLE - BLACK
	H-38617031	ALL	CREVICE TOOL - LONG GRAPHITE GRAY
	H-38617033	ALL	CREVICE TOOL - SHORT
	H-38634078	ALL	EXTENSION TUBE - BLACK
	H-43414197	ALL	DUSTING BRUSH ASSEMBLY - BLACK
	H-49129032	ALL	TURBINE HAND TOOL
	H-43434043	ALL	HOSE ASSEMBLY DELUXE - 20' EXTRA REACH
	H-59156137	UH40145B - ALL	BARE FLOOR BRUSH
	H-59132033	ALL	12" HARD FLOOR BRUSH - BLACK

MODEL No.

U5762-900
UH40020
UH40065
UH40145B
UH40265