

This Owner's Manual is provided and hosted by [Appliance Factory Parts](#).

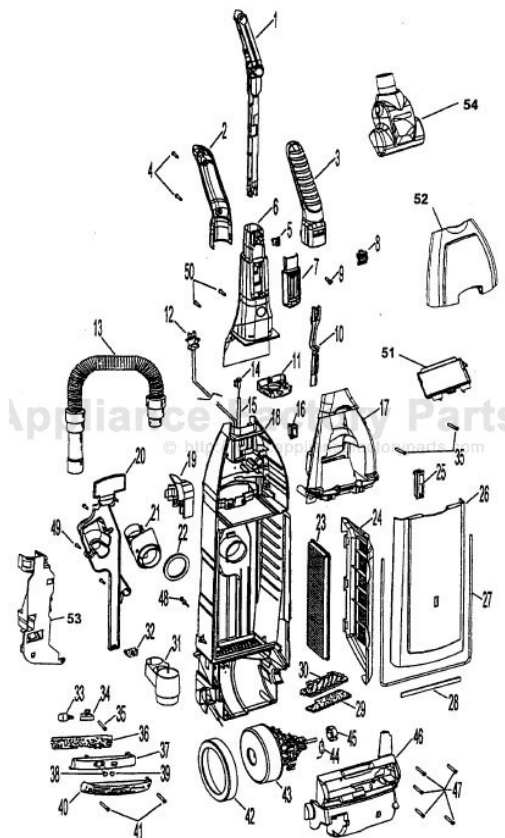

# HOOVER U6437-900 Owner's Manual

[Shop genuine replacement parts for HOOVER  
U6437-900](#)



[Find Your HOOVER Vacuum Cleaner Parts - Select From 1456 Models](#)

----- Manual continues below part list -----

## Available Replacement Parts for HOOVER U6437-900

<a href="#">H-4010100Y</a>	BAG VACUUM CLEANER OEM HOOVER 3 PACK
<a href="#">HR-1028</a>	BELT, FLAT, UPRIGHTS, 1PK
<a href="#">HR-1856</a>	FILTER HOOVER
<a href="#">HR-1832</a>	FILTER FOR VACUUM 2 pack
<a href="#">H-40201200</a>	V BELT, W/POWER DRIVE, 1PK
<a href="#">K-109289</a>	BULB
<a href="#">H-38434021</a>	HANDLE RELEASE LEVER
<a href="#">H-43244005</a>	Rear wheel
<a href="#">HR-2003</a>	AGITATOR ASSY, COMPLETE

Self Propelled WindTunnel w/ onboard Turbine Tool

Model U6430-900, U6432-900, U6433-900,  
U6435-900, U6436-900, U6437-900,  
U6439-900, U6446-900, U6459-900  
Model U6429-900

Farrington S/P W/T w/ onboard Turbine Tool

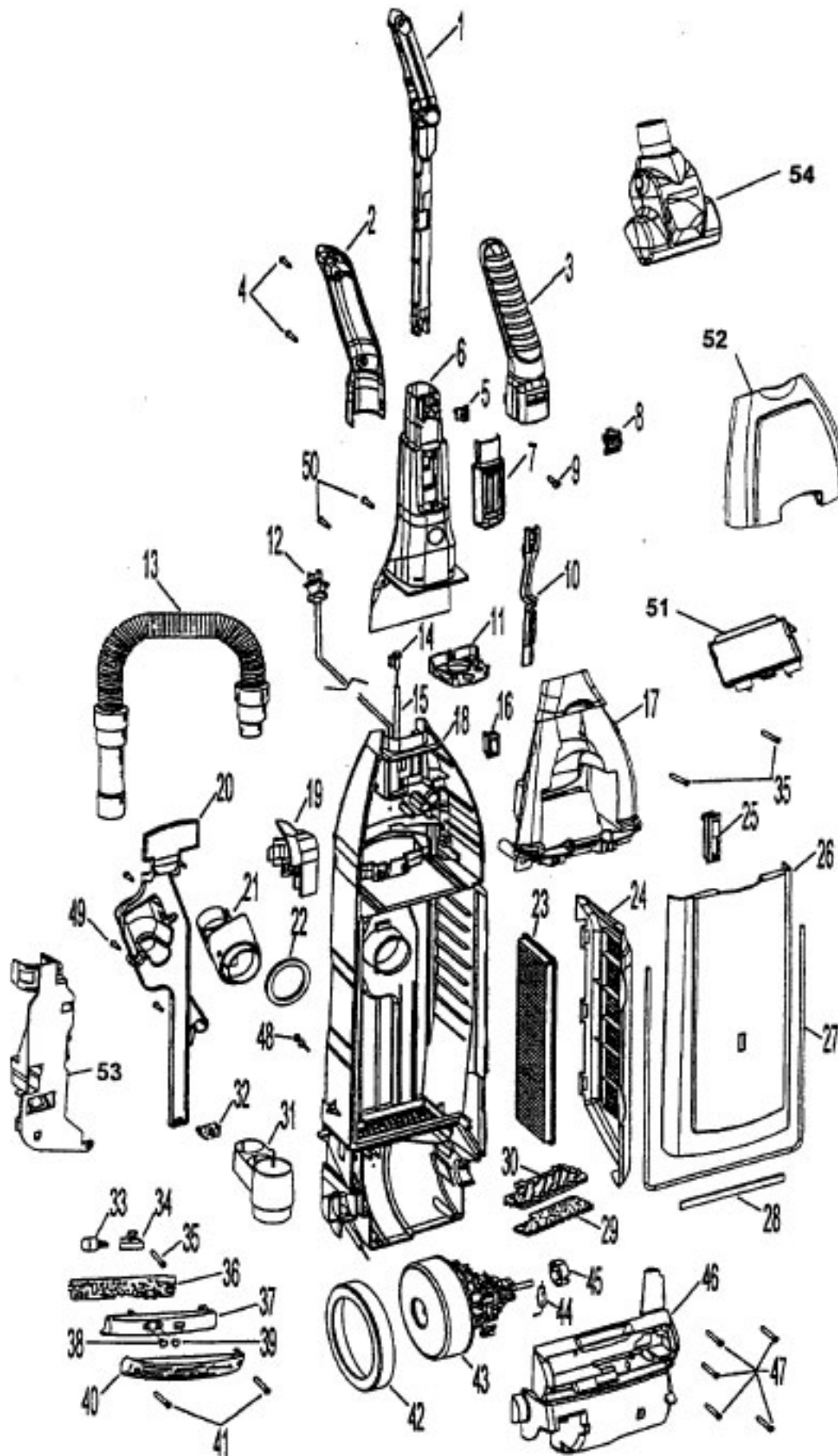

## Farrington S/P W/T w/ onboard Turbine Tool

Ref. No.	Part No.	Description
1	38512001	Grip Rod
2.	39454068	Handle Grip - Back
3.	39454062	Handle Grip - Front (Inc. item 5)
4.	21447228	Screw (2)
5.	36142002	Drive Control Pin
6.	39466040	Upper Handle (Inc. items 7, 8, 10)
7.	37258119	Switch Rod Pocket
8.	38421098	Switch Button
9.	21447242	Screw
10.	38458051	Switch Rod
11.	36923003	Rod Guide
12.	46383331	Attachment Cord Assembly - 35 ft.
13.	43434031	Hose Assembly
14.	43211019	Control Cable
15.	66661205	Control Cable Tube
16.	28161067	Switch
17.	36433153	Tool Holder
18.	37255028	Bag Hsg. (Inc. items 15, 16, 48)
19.	36433136	Hose Holder - Upper
20.	37255010	Rear Cover
21.	47823004	EDF Duct / Mic Assembly
22.	31178017	Hose Connector Gasket
23.	40120101	Final Filter - HEPA
24.	38769004	Final Filter Grille
25.	51151010	Bag Indicator
26.	Note: All bag doors include items 25, 27, 28	
	37254169	Bag Door - AEF - U6446-900
	37254167	Bag Door - ABM -U6430-900, U6435-900
	37254188	Bag Door - ACX - U6432-900, U6439-900
	37254180	Bag Door - AG - U6459-900
	37254192	Bag Door-AFE-U6429-900 - before 12/02
	37254214	Bag Door - AAY - U6429-900 after 12/02
	37254219	Bag Door - AEX - U6433-900
	37254217	Bag Door - AEF - U6437-900
	37254227	Bag Door - AG - U6436-900
27.	38781057	Bag Door Gasket
28.	34123050	Bag Door Gasket - Bottom
29.	38765019	Secondary Filter
30.	36426034	Secondary Filter Retainer
31.	41426150	Wand / Hose Holder (Inc. hose)
32.	34131005	Wire Opening Seal
33.	27313101	Bulb
34.	47173028	Wiring Harness - U6433-900, U6439-900, U6446-900, U6459-900
	47173027	Wiring Harness - U6429-900, U6430-900, U6435-900
35.	21447072	Screw
36.	46851031	PCB - U6433-900, U6446-900, U6459-900, U6437-900, U6439-900
37.	37944011	EDF Cover - U6433-900, U6439-900, U6446-900, U6437-900
	37944012	Panel - U6430-900,U6432-900 U6435-900, U6436-900

Ref. No.	Part No.	Description
38.	27352031	Snap in Lens - Green (Models w/EDF)
39.	27352030	Snap in Lens - Red (Models w/EDF)
40.	39383100	Lens
41.	21447228	Screw
42	36322035	Motor Mount - Large
43.	43576191	Motor Assembly
	43566016	Fan Assembly
	41311017	Motor Brush Assembly (2 required)
44.	28382093	Thermal Protector
45.	36322030	Motor Mount - Small
46.	37195107	Motor Cover
47.	21447230	Screw
48.	23149001	Tapping Screw and Washer Assembly
49.	21447242	Screw
50.	21447072	Handle Screws
51	36433155	Tool Holder Cap
52	37257250	Tool Door
53	36433154	Tool Rack - Rear
54	40200013	Turbine Powered Hand Tool - (P - 357)
	49129014	PHT - (P.357) U6429-900 models before 12/02. Models after 12/02 used 40200013

## Items Not Illustrated

3944201P	Cord Wrap - Upper
4010100Y	Throw Away Bag - 3 pk.
34131019	Wire Opening Plug
21447242	Screw for Hose Holder (Item 19)
36131101	Control Cable Support
49811074	Lead Wire White -(From cord to motor)
36215028	Cord Protector
36436014	Handle Sleeve (inc. with item 6)

## Tools

43414162	Dusting Brush Assembly
3861401E	Furniture Nozzle
38617027	Crevice Tool
38634078	Extension Tube (2)
43434042	Hose Assembly -Extra - 20' stretch U6446-900, U6459-900

## Packaging

56511B22	Owner Manual - U6439-900
58186039	Carton - w/o Point of Sale Label - U6446-900
58164022	Carton - w/o Point of Sale Label - U6430-900, U6433-900, U6435-900, U6432-900, U6459-900
56511B28	Owner Manual U6459-900
56511B34	Owner Manual U6429-900 models before 12/02. Models after 12/02 used 56511B22
56511B80	Owner Manual - U6437-900

Self Propelled - Ultra

Self Propelled - Premium w/ EDF

Model U6423-900, U6425-900, U6425-920, U6473-900

Model U6431-900, U6441-900, \*\*U6441-940, U6445-900, U6445-920

U6449-900, U6450-900, U6451-900, \*U6451-960, U6455-900, U6455-960,

U6458-900, U6470-900, U6470-910, U6471-900

Farrington S/P W/T w/ onboard Turbine Tool

Model U6429-900

Self Propelled WindTunnel w/ onboard Turbine Tool

Model U6430-900, U6432-900, U6436-900, U6439-900, U6433-900,

U6435-900, U6437-900, U6446-900, U6459-900, U6460-900

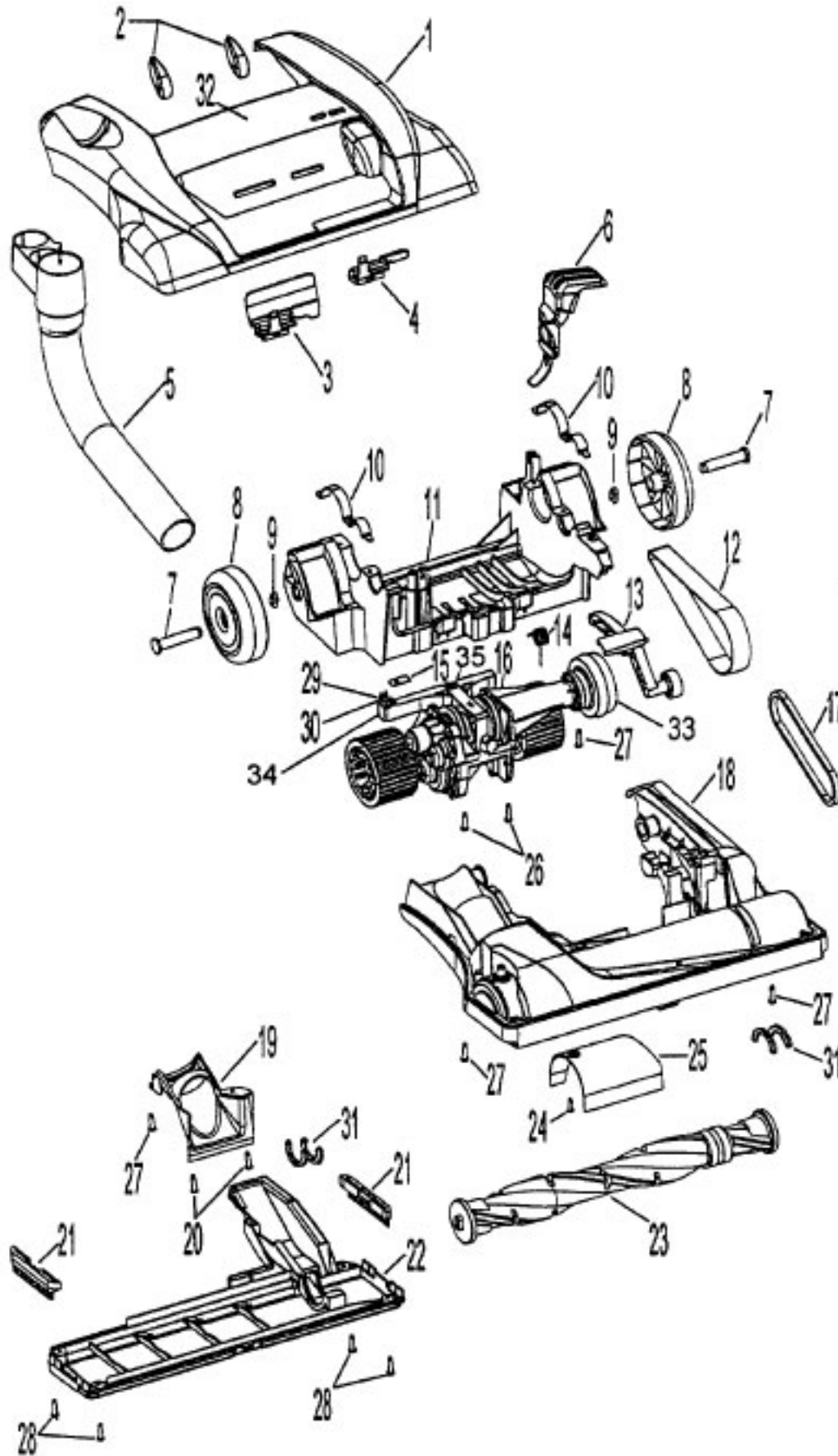

Ultra  
Self Propelled - Premium w/ EDF

Model U6423-900, U6425-900, U6425-920, U6473-900  
Model U6431-900, U6441-900, \*\*U6441-940, U6445-900, U6445-920  
U6449-900, U6450-900, U6451-900, \*U6451-960, U6455-900, U6455-960,  
U6458-900, U6470-900, U6470-910, U6471-900

Farrington S/P W/T w/ onboard Turbine Tool

Model U6429-900

Self Propelled WindTunnel w/ onboard Turbine Tool

Model U6430-900, U6432-900, U6436-900, U6439-900, U6433-900,  
U6435-900, U6437-900, U6446-900, U6459-900, U6460-900

Ref. No.	Part No.	Description	Ref. No.	Part No.	Description
1		<b>Note: All Hood Assembly's include lt. 2,3 and 4.</b>			<b>Torsion Spring &amp; 37243013 Duct Cover Nozzle)</b>
	37253301	Hood -ABM - U6425-900 ,U6425-920 U6430-900, U6435-900		37243014	Agitator Housing - Late Models produced after 9/98 - (Incl. lt. 31)
	37253300	Hood - ACJ -U6445-900, U6445-920 U6451-900, U6458-900	19.	36172007	Hose Clamp
	37253302	Hood - AG - U6436-900, U6455-900, U6455-960, U6459-900	20.	21479446	Screw - Hose Clamp
	37253304	Hood - ACM - U6449-900	21.	39511004	Litter Picker
	37253309	Hood - ABY - U6423-900		39511008	Litter Picker -U6430-900,U6432-900, U6435-900, U6446-900, U6439-900
	37253317	Hood - ABR - U6441-900, U6450-900	22.	42245030	Bottom plate (Inc. item 31)
	37253348	Hood - AAY - U6429-900 before 12/02, U6431-900	23.	48414069	Agitator Assembly Complete
	37253384	Hood - AFE - U6431-900 after 6/01, U6429-900 after 12/02	24.	21479446	Screw
	37253351	Hood - AEC - U6470-900, U6470-910	25.	37243026	Duct Cover Nozzle - Early - models produced 9/98 and earlier
	37253359	Hood - AEF - U6446-900, U6437-900 U6460-900		37243013	Duct Cover Nozzle - Late - models produced after 9/98
	37253380	Hood - ACX - U6432-900, U6439-900	26.	21447242	Screw - Trans. to main body
	37253398	Hood - AFK - U6471-900	27.	21447228	Screw
	37253A24	Hood - AEX - U6433-900	28.	21447121	Screw - Bottom plate
	37253403	Hood - ADJ - U6473-900	29.	21751010	Screw - Special
2.	38421094	Adjustment Knob (2)	30.	36128002	Washer
3.	38563026	Nozzle Adjustment Cam	31.	38781053	Agitator Pulley Seal
4.	36143004	Idler Arm Lock	32.	52115209	Hood Label - U6425-900
5.	41426150	Wand / Hose Holder		51438007	Hood Label - U6445-900, U6449-900, U6450-900, U6451-900, U6458-900, U6470-900
6.	38434021	Handle Release Lever - Models produced before February 2001		51438008	Hood Label - U6455-900, U6455-960
	38434023	Handle Release Lever - Models prod. February 2001 and later		51438012	Hood Label - U6431-900
7.	32434008	Rear Axle (2)		51438022	Hood Label - U6431-900 after 6/01
8.	43244005	Rear Wheel Assembly - Deluxe with rubber tread - (2)		52115213	Hood Label - U6423-900
	38522077	Rear Wheel		51438014	Hood Label - U6446-900
9.	160017	Retaining Ring		51438021	Hood Label - "12 Amp" - U6446-900
10.	36131096	Trunnion Cover (2)		52115219	Hood Label - U6429-900 after 12/02, U6430-900, U6435-900
11.	37241150	Main Body - models produced before February 2001		52115220	Hood Label - U6432-900, U6433-900 U6439-900, U6473-900
	37241161	Main Body - models prod. February 2001 and after		51438021	Hood Label - U6470-910
12.	38528035	Flat Belt		51438023	Hood Label - U6459-900, U6436-900
13.	43241004	Idler Arm Assembly		52115222	Hood Label - U6441-900
	43241006	Idler Arm Pulley (Only)		52115223	Hood Label - U6429-900 before 12/02
14.	38356015	Torsion Spring - early models - models produced 5/98 and earlier		51438025	Hood Label - U6471-900, U6437-900
	38356014	Torsion Spring - late models - models produced after 5/98	33.	38537013	Drive Pulley
15.	34125004	Retainer - Control Cable		160031	Nut for Pulley
	21447242	Screw - (2) - (Retainer mounting screws)	34.	43143046	Actuator Arm
16.	43124016	Power Drive Assembly	35.	013759--	E Clip
17.	38528034	V Belt - Agitator	<b>Items not illustrated</b>		
18.	42246136	Agitator Housing - Early Models produced 9/98 and earlier (inc. items 24, 25, 31) (Use 37243014 Agitator Housing plus 38356014		36131101	Control Cable Support
				38313037	Spring - Between trans. & agit. hsg. - late models

\* Model U6451-960 is similar to model U6451-900 except for additional (9) type Y Allergen Bags, (1) Crevice Tool, (1) Final Filter, (2) flat belts.

\*\* Model U6441-940 is a model U6441-900 with a bonus hose.