

This Owner's Manual is provided and hosted by [Appliance Factory Parts](#).

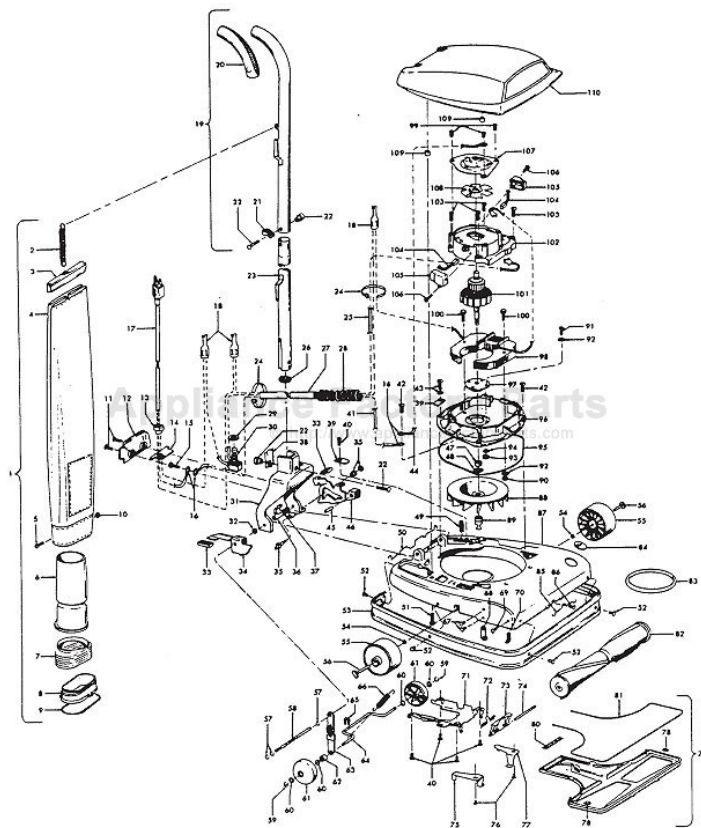

HOOVER U7021 Owner's Manual

[Shop genuine replacement parts for HOOVER U7021](#)



[Find Your HOOVER Vacuum Cleaner Parts - Select From 1456 Models](#)

----- Manual continues below part list -----

Available Replacement Parts for HOOVER U7021

[H-43267002](#)

AGITATOR BEARING ASM

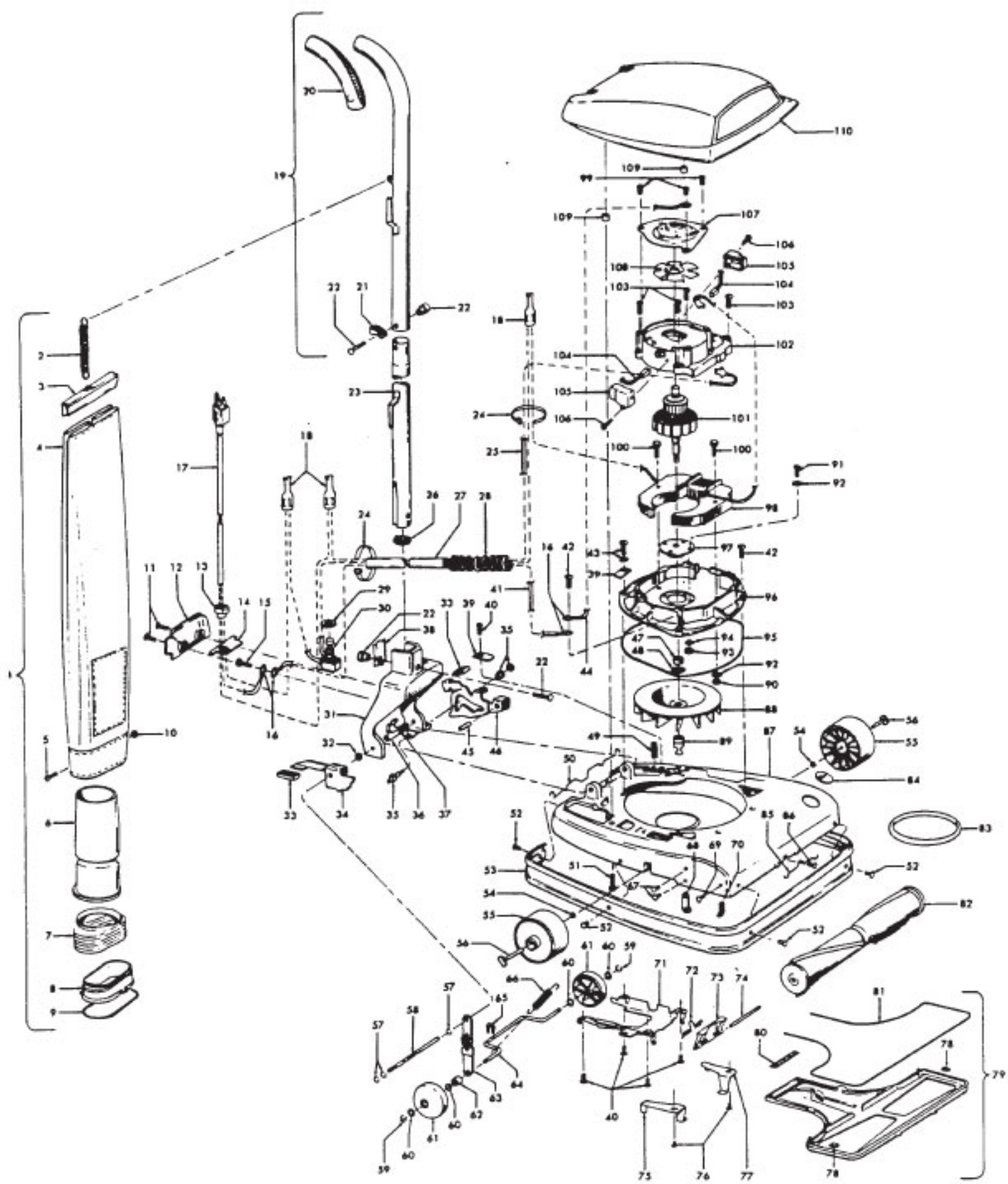

Models U7019, U7021, U7033

Ref. No.	Part No.	Description	Ref. No.	Part No.	Description
1	43675131	Outer Bag Comp .	45	47450AY	Pivot Pin
2	38336014	Bag Support Spring	46	38458050	Handle Control Lever
3	43362	Bag Closure Clip & Spring		43137036	Handle Control Lever - U7033
4	43675131	Outer Bag	47	163059	Fan Spacer
5	21765159	Screw - Machine	48	169241AW	Washer
6	161889	Support Tube	49	12559FW	Handle Control Lever Spring
7	11064JM	Bellows	50	34344FW	Bag Flange Retaining Spring
8	41424011	Bag Flange & Gasket	51	16903	Screw - Self Tapping (2)
9	47454	Bag Flange Gasket	52	32242004	Rivet - Tubular (6)
10	15854EF	Nut Special	53	36231037	Furniture Guard -AG
11	21481273	Screw - Self Tapping (2)		36231038	Furniture Guard - U7033
12	37954001	Bail Cover Plate	54	13730	Lock Ring (2)
13	165371	Strain Relief	55	34791AG	Carrier Wheel (2)
	27482120	Strain Relief - U7033	56	47457AY	Carrier Wheel Shaft (2)
14	34223004	Strain Relief Mounting Plate - U7019 U7021	57	13730	Lock Ring (3)
	34223007	Strain Relief Mounting Plate - U7033	58	161509AY	Bail Shaft
15	166735EF	Screw - Self Tapping Not Applicable - U7033	59	17207AZ	Spring Lock Ring (2)
16	27661503	Ring Tongue Terminal (4) Not Applicable - U7033	60	21312772	Washer (4)
17	46583031	Cord - U7021	61	38521041	Rear Wheel Assm. - AG (2)
	46383068	Attach. Cord - U7019	62	31148004	Spacer
	46383137	Attach. Cord - U7033	63	161514	Cam Follower Assm.
18	12227	Insulated Terminal (3)	64	33152003	Rear Wheel Shaft
19	48646054	Handle Assm.	65	34252005	Yoke
	48644022	Handle Assm. Comp. - Upper H U7033	66	161513	Spring
20	23458AG	Handle Grip	67	48422	Rivet - Tubular (4)
	23458PH	Handle Grip - U7033	68	34355002	Agitator Support Plate (2)
21	14492	Cord Clamp	69	32243001	Agitator Clamp Support Rivet (2)
22	48294AW	Handle Bolt & Nut (2)	70	47259AY	Agitator Clamp Spring (2)
23	48631057	Handle Assm. - Lower Half	71	36435016	Converter Housing - U7019, U7033
	48631006	Handle Assm. Comp. - Lower H - U7033	72	45191	Converter Valve Spring
24	27479307	Lead Wire Tie (2)	73	34350	Converter Valve
25	46213006	Lead Wire Assm. - White	74	17465AY	Converter Valve Shaft
	46171003	Lead Wire - White - U7033	75	35446003	Bottom Plate Latch - R.H.
26	37911035	Handle Plug - AG	76	12456	Rivet - Tubular (2)
27	31727010	Cord Cover Tubing - AG	77	35446005	Bottom Plate Latch - L.H.
28	38313023	Motor Lead Spring	78	34111001	Support Pad (2)
29	12560	Switch Nut	79	167238	Bottom Plate Assm.
30	28212017	Switch	80	47237	Converter Valve Felt
31	41416010	Bail - AG	81	31718001	Bottom Plate Seal
32	161507	Washer	82	41435005	Agitator Assm. Comp.
33	38426071	Foot Pad (2)	83	44783AG	Belt
	38426072	Foot Pad (2) - U7033	84	51661008	Medallion
34	161511AY	Nozzle Adj. Lever	85	34439	Bottom Plate Spring
	43137013	Nozzle Adj. Lever - U7033	86	161882	Rivet - Tubular
35	11735	Roller Detent Assm.	87	42242062	Main Casting
36	19907	Bag Flange Clamp Lever		42242064	Main Casting - Polished - U7033
37	48409FW	Bag Flange Clamp Lever Spring	88	38755011	Fan - Polycarbonate (Black)
38	35463002	Handle Retainer Plate - AW		22556	Die Cast (Aluminum)
39	34665007	Pivot Pin Retainer (2)	89	38532009	Motor Pulley (Use w/Item 88 - 38755011)
40	21767082	Machine Screw (5)	90	15673	Nut (2)
41	46214002	Lead Wire Assm. - Green Not Applicable - U7033	91	21772501	Screw (4)
42	45355	Screw - Machine (3)	92	14062	Lock Washer (6)
43	14279	Screw Assm.	93	45251	Nut (4)
44	46128002	Jumper Lead - Green Not Applicable - U7033	94	19772	Washer (4)
			95	47232	Motor Gasket (Use w/Item 96 - 11062)
			96	42193006	Motor Casing - Lower Half w/Sealant
				11062	Motor Casing - Lower Half
			97	19829	Motor Bearing
			98	45412014	Field - U7033

Ref. No.	Part No.	Description
	45412015	Field - U7021
	45415001	Field - U7019
99	45533AY	Screw - Machine (4)
100	45118	Bolt (2)
101	44755002	Armature Assm. - U7019
	44765085	Armature Assm.
102	19857	Motor Casing & Brush Holder Assm.
103	161535	Screw - Self Tapping (4)
104	47318012	Motor Brush Assm. (2)
105	36315003	Motor Brush Holder Insulator (2)
106	46930AZ	Screw - Self Tapping (2)
107	42934002	Motor Casing Cap Assm.
108	38755004	Fan Assm.
109	16125AY	Fastener (2)
110	42251325	Motor Hood Assm. - AAW
	161649JM	Hood & Lens Assm. - U7033 (Order Lens # 16295CA)

NOTE: Model U7033 Din Finder Lamp - Switch Components
Refer to Model U4057, U4059, U4061 - U4063 Schematics

29	164684	Insulation Shield
35	12892	Screw
36	14287	Washer
37	19513AG	Speed Control Switch
38	14279	Screw Assm.
39	18589	Switch Bracket
40	45355	Screw
41	18588	Switch Actuator
42	42241	Dirt Finder Lamp
43	17016	Dirt Finder Socket Assm.
111	162954CA	Lens

ITEMS NOT ILLUSTRATED

25084	Plug (3 Wire) - U7019
43574193	Motor Assm. Comp. - U7021 (P. 22)
43574140	Motor Assm. Comp. - U7033 (P.27)
43574008	Motor Assm. Comp. - U7019 (P28)
31162004	Washer - Heat Insulating (Use in conjunction w/Item 88 - 3875501 0)
68564063	Sealant (3 oz. tube, Seal for Motor Casing - Lower Half)
40300014	Armature Spacer/Split Sleeve Kit (For use with Lower Mtr. Brgs. with 4 Attachment Holes)

PACKAGING MATERIAL

56511013	Owner Manual
56511038	Owner Manual - U7033

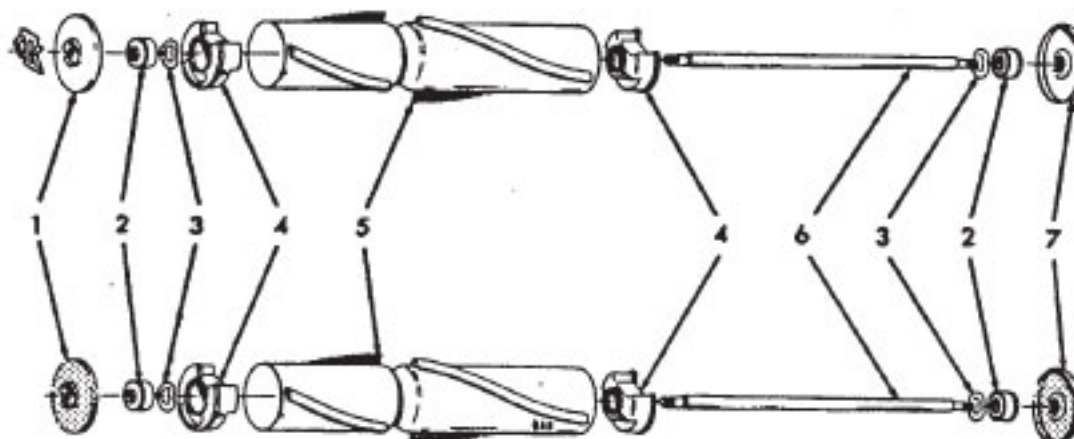
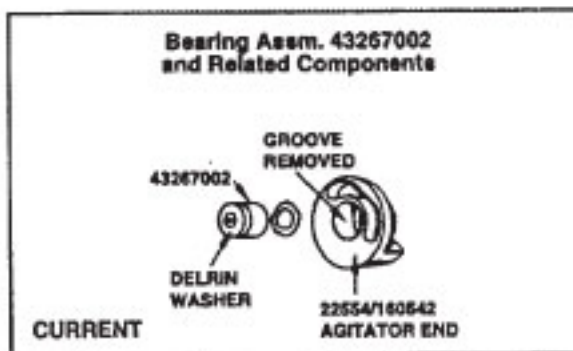
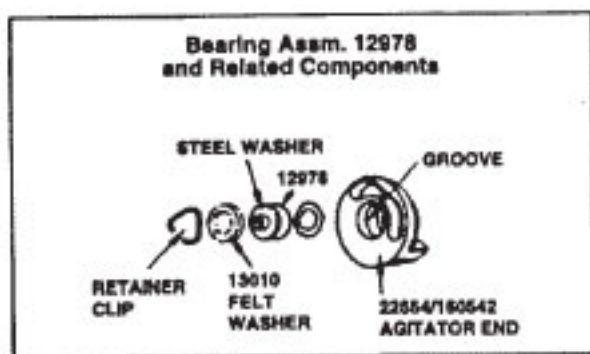

Ref. No.	Part No.	Description
1	49180 36423003	Thread Guard & Spring (Metal) Thread Guard L.H. (Molded)
2	43267002	Bearing
3	21347003	Thrust Washer
4	22554 160542 41435070	Agitator End (Early Model Standard Performance Cleaners, L.H. Helix) Agitator End (Standard & High Performance Cleaners, R.H. Helix) Agitator End (Use w/two brush agitator Pt. #48414021)
5	12998BZ 160646BZ 48445001	Agitator Brush - 8 mil (Early Model Standard Performance Cleaners, L.H. Helix) Agitator Brush - 8 mil (Standard Performance Cleaners, R.H. Helix) Agitator Brush - 11 mil (High Performance Cleaners, R.H. Helix)
6	12981 32724008	Agitator Shaft (Used w/metal thread guards) Agitator Shaft (Used w/molded thread guards)
7	12985AY 36423007	Thread Guard R.H. (Metal) Thread Guard R.H. (Molded)

AGITATOR BELT

49258AG	Domestic models, Convertible/Decade 80/Heavy Duty Commercials
44783AG	Lightweight Commercials

AGITATOR ASSEMBLY

169371MF	Standard Performance, R.H. Helix (Metal Thread Guards)
41435005	High Performance Cleaners, R.H. Helix (Metal Thread Guards w/Spdng)
48414006	High Performance Cleaners, R.H. Helix (Metal Thread Guards)
48414007	Standard Performance, R.H. Helix (Molded Thread Guards)

FOUR BRUSH AGITATOR ASSEMBLY

48414002	Heavy Duty Commercial (Use 47159 Brush-Long, 47160 Brush-Short & 46875 Sems Fastener)
48414003	Lightweight Commercial (Use 160646BZ Brush & 36422003 Agitator End)

TWO BRUSH W/O BEATER BAR

48414021	Agitator (Molded Thread Guards)
----------	---------------------------------