

This Owner's Manual is provided and hosted by [Appliance Factory Parts](#).

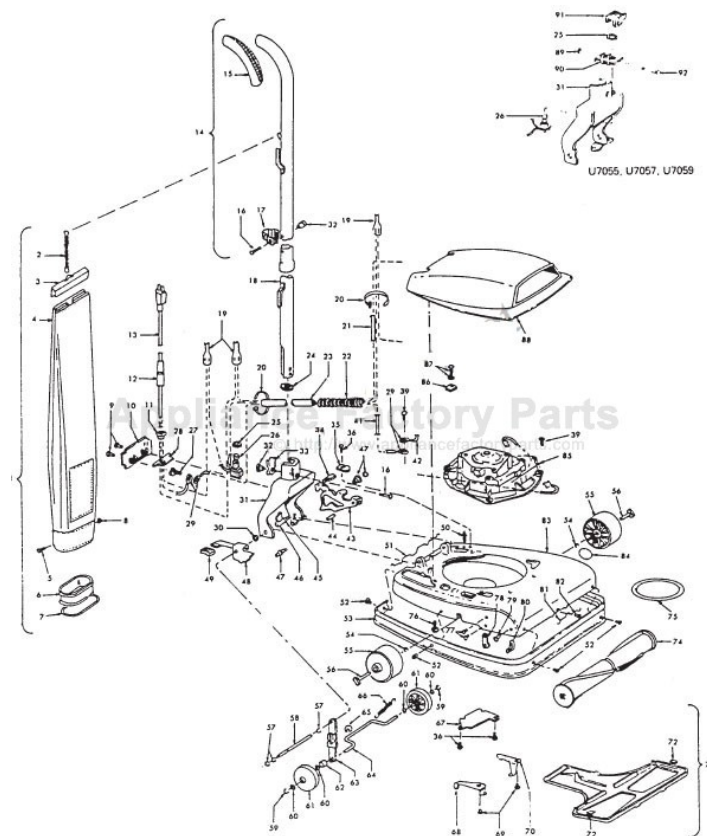

# HOOVER U7057 Owner's Manual

[Shop genuine replacement parts for HOOVER U7057](#)



[Find Your HOOVER Vacuum Cleaner Parts - Select From 1456 Models](#)

----- Manual continues below part list -----

## Available Replacement Parts for HOOVER U7057

<a href="#">H-44783</a>	BELT, ROUND, 1PK
<a href="#">H-43267002</a>	AGITATOR BEARING ASM
<a href="#">H-49258</a>	ROUND CONVERTIBLE/DECADE BELT FOR HOOVER

# HOOVER Original

INDUSTRIAL UPRIGHT

Models U7039, U7041, U7043, U7045, U7047, U7055, (220V), U7057, U7059

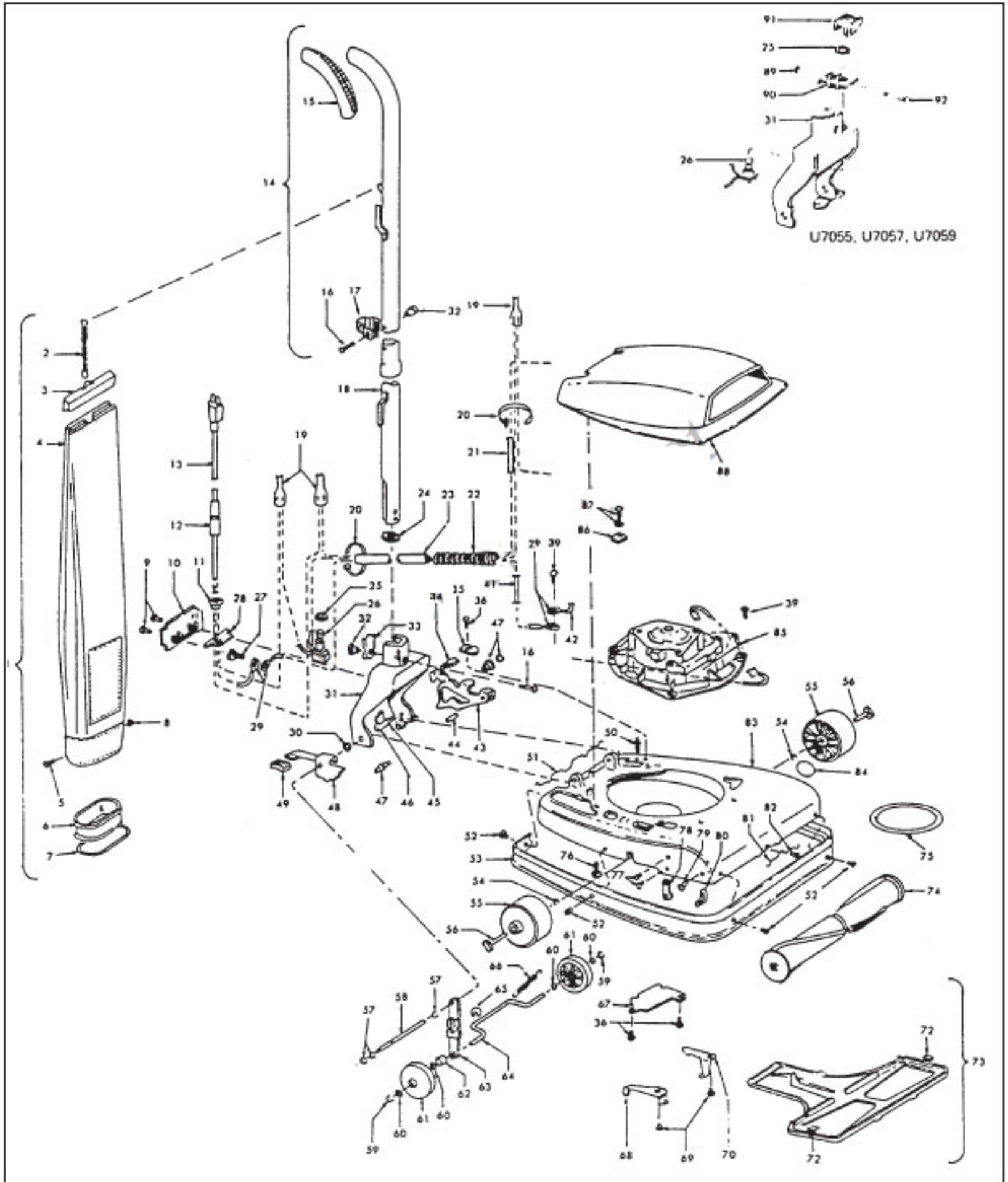

Original

**HOOVER**

INDUSTRIAL UPRIGHT

Models U7039, U7041, U7043, U7045, U7047, U7055 (220V), U7057, U7059

KEY	PART NO.	DESCRIPTION	KEY	PART NO.	DESCRIPTION
1	NLA	Outer Bag Comp. - Cloth	34	H-38426063	Foot Pad
2	H-44475 AW	Bag Support Spring	38	H-38426064	Foot Pad - U7055, U7057, U7059
3	NLA	Bag Closure Clip & Spring - U7039, U7041	35	H-34665007	Pivot Pin Retainer
	H-41424006	Bag Closure Clip & Spring - U7043, U7045, U7047, U7055, U7057, U7059	36	NLA	Machine Screw
4	NLA	Outer Bag - Cloth	39	H-45355	Machine Screw
5	H-15980	Screw - Machine	41	H-46214002	Lead Wire - Green
6	H-41424011	Bag Flange & Gasket - U7039, U7041	42	H-46128002	Jumper Lead - Green
	H-41424012	Bag Flange & Gasket	43	H-38456050	Handle Control Levor
7	H-47454	Bag Flange Gasket (use w/48961)	44	H-47450 AY	Pivot Pin
8	H-15854 EF	Nut - Special	45	H-48409 FW	Bag Flange Clamp Lever Spring
9	H-21481273	Screw - Self Tapping (2)	46	H-36153034	Bag Flange Clamp Lever
10	H-37954001	Bail Cover Plate	47	H-11735	Roller Detent Ass'y
11	H-165371	Strain Relief-U7039, U7041	48	NLA	Nozzle Adj. Lever
	H-39049	Strain Relief	49	H-38426071	Foot Pad
12	H-36215001	Cord Protector - U7043, U7045, U7047, U7055, U7057, U7059		NLA	Foot Pad - U7055, U7057, U7059
13	H-46583092	Attach. Cord - NM - 3W - 35'	50	H-12559 FW	Handle Control Lever Spring
	H-46583089	Attach. Cord - NM - 3W - 29' - 220V	51	NLA	Bag Flange Retaining Spring
	H-46583090	Attach. Cord - NM - 3W - 50' - 220V	52	H-32242004	Rivet - Tubular (6)
	H-46583095	Attach. Cord - NM - 3W - 50'	53	H-36231037	Furniture Guard - AG
14	NLA	Handle - Upper Half - AG - U7039, U7041, U7043, U7045, U7047 (Items 16, 17, 32 Not Included)	54	H-13730 FW	Lock Ring (2)
	NLA	Handle - Upper Half - AG - U7055, U7057, U7059	55	H-34791Y	Carrier Wheel (2)
15	H-23458 AG	Handle Grip	56	H-47103, *	Carrier Wheel Shaft (2)
16	H-48294 AW	Handle Bolt & Nut - U7039, U7041	57	H-130 FW	Lock Ring (3)
	H-21631302	Handle Bolt	58	H-16112 AY	Bail Shaft
17	H-14492	Cord Clamp - (Plastic) U7039, U7041	59	H-47107 AZ	Spring Lock Ring (2)
	H-34785015	Cord Retainer Clip Metal - AG)	60	H-4712772	Washer (4)
18	NLA	Handle - Lower Half - AG	61	H-33321041	Rear Wheel (2)
19	H-12227	Insulated Terminal (3)	57	H-31148004	Spacer
20	H-27479307	Lead Wire Tie	62	NLA	Cam Follower Ass'y
21	H-46213006	Lead Wire - White	64	H-33152003	Rear Wheel Shaft
22	H-38313023	Motor Lead Spring	65	H-34252005	Yoke
23	H-31727010	Cord Cover Tubing - AG	66	H-161513	Spring
24	H-37911035	Handle Plug	67	H-35434040	Axle/Bag Flange Retainer
25	H-12560	Switch Nut		H-34314002	Axle/Bag Flange Retainer - U7055
26	H-28212017	Switch	68	H-35446003	Bottom Plate Latch - R.H.
27	H-166735 EF	Screw - Self Tapping - U7039, U7041	69	H-12456	Rivet - Tubular (2)
	NLA	Screw - Sems	70	H-35446005	Bottom Plate Latch - L.H.
28	H-34223004	Strain Relief Mounting Plate	72	H-34111001	Support Pad (2)
29	H-27661503	Ring Tongue Terminal	73	H-42246008	Bottom Plate Ass'y
30	H-161507	Washer	74	NLA	Agitator Comp.
31	H-41416010	Bail - AG		H-48414003	Agitator - Four Brush - U7047, U7059
32	H-43294 AW	Handle Bolt & Nut - U7039, U7041	75	H-44783 AG	Belt
	H-32277008	Handle Nut	76	H-16903	Screw - Self Tapping (2) (Use on Hoods w/Capserts)
33	H-35463002	Handle Retainer Plate - AW		H-21447020	Screw - Self Tapping (Use on Hoods w/o Capserts)
			77	H-48422	Rivet - Tubular (4)
			78	H-47260 FW	Agitator Support Plate (2)
			79	NLA	Agitator Clamp Support Rivet (2)
			80	H-47259 AY	Agitator Clamp Spring (2)

# **HOOVER** Original

## INDUSTRIAL UPRIGHT

Models U7039, U7041, U7043, U7045, U7047, U7055 (220V), U7057, U7059

KEY	PART NO.	DESCRIPTION
81	NLA	Bottom Plate Spring
82	H-161882	Rivet - Tubular
83	H-42242058	Main Casting
84	NLA	Medallion
85	NLA	Motor Comp.-U7039, U7043, U7055 - 220V
	H-43574136	Motor Comp.-U7057, U7059, U7041, U7045, U7047 - 1 Spd.
86	H-34665007	Pivot Pin Retainer (2 Req.)
87	H-14279	Screw Ass'y
88	H-42251293	Hood - U7039, U7041, U7043, U7045, HU7047
	H-42251271	Hood - U70H55, U7057, U7059
89	H-24735022	Circlip - U7055, U7057, U7059
90	H-35217006	Mounting Bracket - AG - U7055, U7057, U7059
91	H-38424003	Switch Pedal - U7055, U7057, U7059
92	H-613802	Shaft - U7055, U7057, U7059

### ITEMS NOT ILLUSTRATED

H-11064 JM	Bellows - U7039, U7041
H-13704	Lock Washer (Handle Bolt)
H-25084	Plug (3 Wire) - U7039, U7043, U7055
<b>H-161869</b>	Support Tube - U7039, U7D41
<b>H-36215001</b>	Cord Retainer - Formed (Bail) - U7055, U7057, U7059
<b>H-36215002</b>	Lead Wire Protector (Bail) - U7055, U7057, U7059
H-48646050	Handle Complete - U7039, U7041, U7043, U7045, U7047
H-48646034	Handle Complete - U7055, U7057, U7059

### PACKAGING MATERIAL

H-58173039	Carton - Common
H-58343025	Front Support
H-58366012	Rear Support
H-56511054	Owner Manual - U7039, U7041
H-56511069	Owner Manual - U7043, U7D45
H-56511068	Owner Manual - U7047
H-56511113	Owner Manual - U7055, U7057
H-56511114	Owner Manual - U7059

# Original **HOOVER** CONVERTIBLE & INDUSTRIAL CLEANER

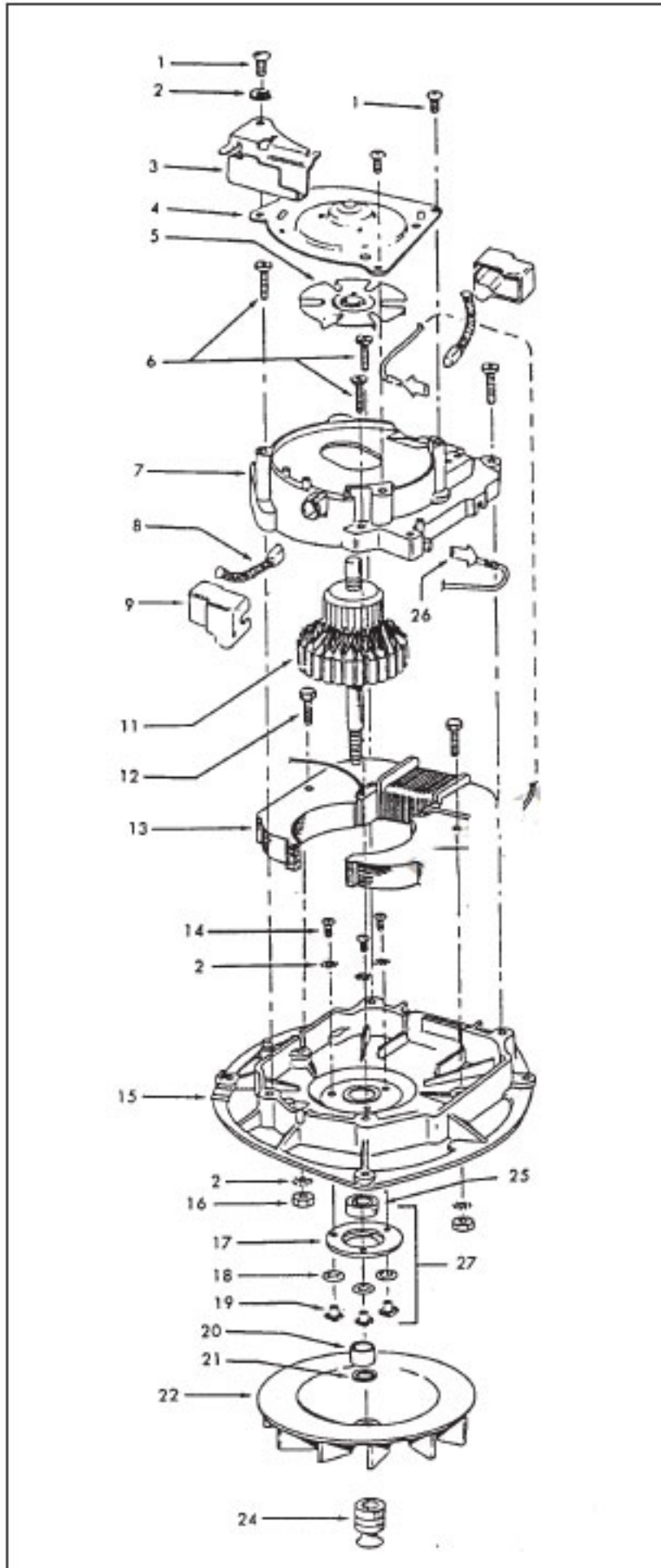

**Motor H-43574128**  
**1-Speed w/Guide**

**Motor H-43574130**  
**1-Speed w/o Guide**

KEY	PART NO.	DESCRIPTION
1	NLA	Screw
2	H-14062	* Washer
3	H-41961009	Indicator Guide
4	H-42934002	Upper Bearing
5	H-38755004	Vent Fan
6	H-161535	* Screw
7	NLA	Upper Motor Casing
8	H-47318012	Carbon Brush
9	H-14322	Brush Insulator
11	H-44765085	Armature Convertible
11	NLA	Armature Industrial
12	H-45118	Bolt
13	NLA	Field Coil
14	H-44779 AV	* Screw
15	H-42192024	Lower Motor Case
16	NLA	Nut
17	NLA	Retainer
18	H-19772	* Washer
19	H-45251	Nut
20	H-31731002	Spacer
21	H-166563	* Washer
22	H-38755010	Fan - Poly
	H-38532009	Motor Pulley Convertible
24	H-43251003	Motor Pulley Industrial
25	H-24152807	Bearing
26	H-14320	* Terminal
27	H-43267006	Bearing Kit 3 Hole
	NLA	Bearing Kit 4 Hole (Not Shown)

**ITEMS NOT ILLUSTRATED**

- H-35276006 Indicator Guide Spring
- H-31162004 Washer Heat Insulating  
Between Pulley & Fan Conv.

NLA = No Longer Available

# Original **HOOVER** CONVERTIBLE & INDUSTRIAL CLEANERS

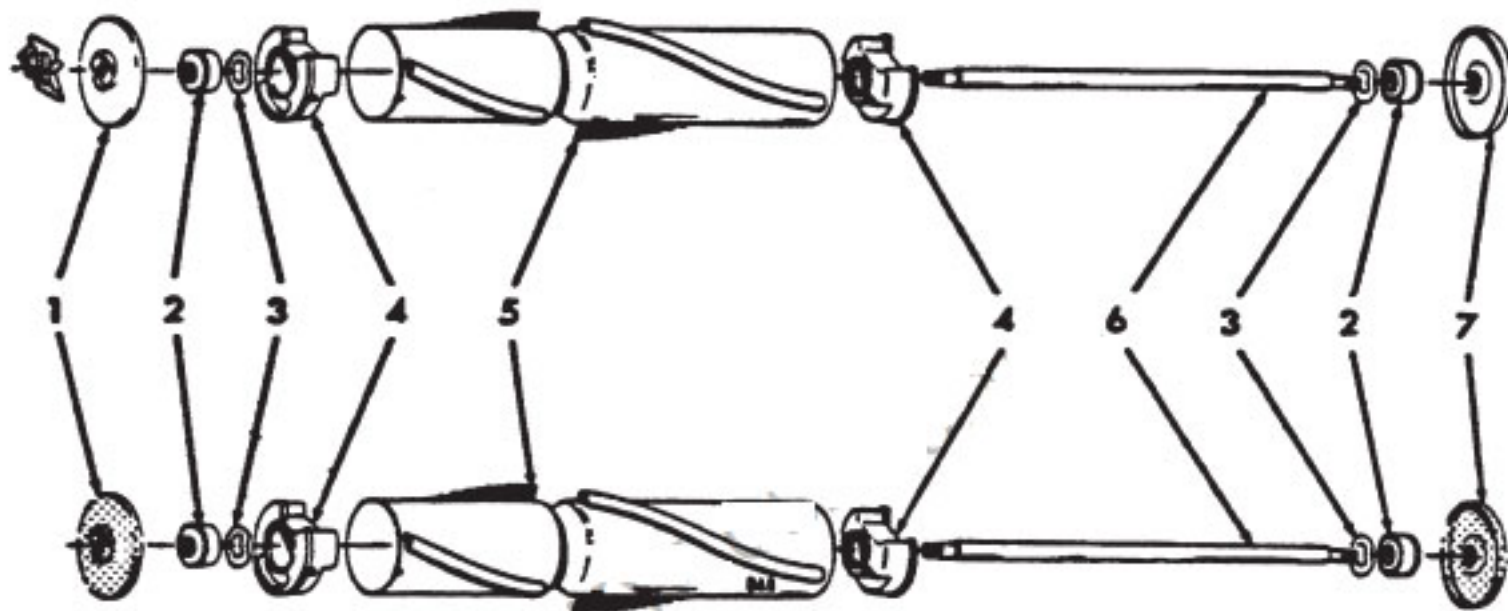
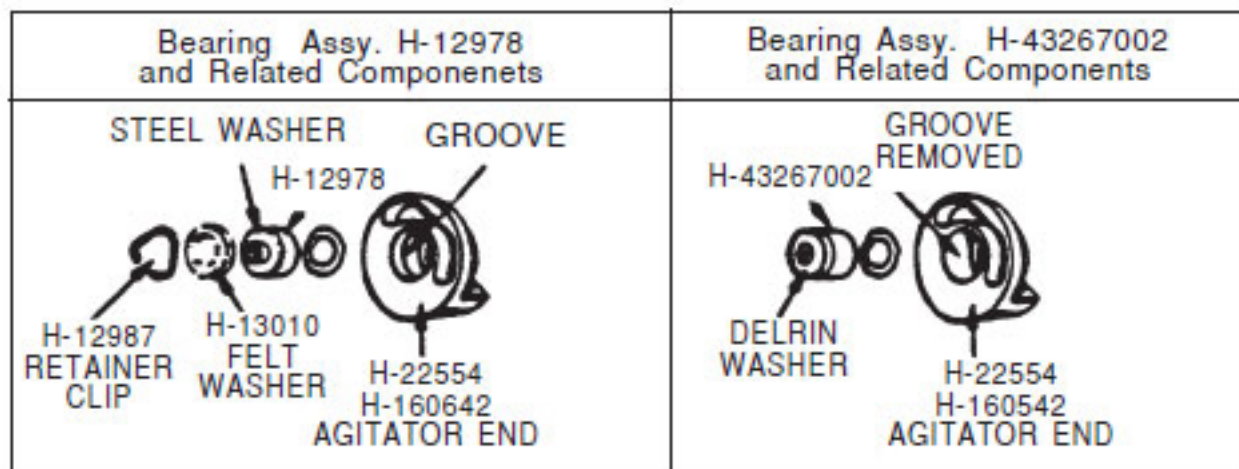

KEY	PART NO.	DESCRIPTION
1	H-49180	Thread Guard & Spring (Metal)
	NLA	Thread Guard L.H. (Molded)
2	H-43267002	Bearing
3	H-21347003	Washer
4	NLA	Agitator End (Early Model Standard Performance Cleaners, L.H. Helix)
4	H-160542	Agitator End (Standard & High Performance Cleaners, R.H. Helix)
4	H-41435070	Agitator End (Use w/two brush Agitator Pt. #48414021)
5	NLA	Agitator Brush-8 mil (Early Model Standard Performance Cleaners, L.H. Helix)
5	H-160646 BZ	Agitator Brush-8 mil (Standard Performance Cleaners, R.H. Helix)
5	H-48445001	Agitator Brush-11 mil (High Performance Cleaners, R.H. Helix)
6	NLA	Agitator Shaft (Used w/metal thread guards)
6	H-32724008	Agitator Shaft (Used w/Molded thread guards)
7	H-12985 AY	Thread Guard R.H. (Metal)
	NLA	Thread Guard R.H. (Molded)

### AGITATOR BELT

H-49258	Domestic Models, Convertible/ Decade 80/Heavy Duty Commercials
H-44783	Lightweight Commercials

KEY	PART NO.	DESCRIPTION
<b>AGITATOR ASSEMBLY</b>		
	NLA	Standard Performance, R.H. Helix (Metal Thread Guards)
	NLA	High Performance Cleaners, R.H. Helix (Molded Thread Guards)
	NLA	Standard Performance, R.H. Helix (Molded Thread Guards)

### FOUR BRUSH AGITATOR ASSEMBLY

NLA	Heavy Duty Commercial (Use 47159 Brush - Long, 47160 Brush - Short and 46875 Sems Fastener)
H-48414003	Lightweight Commercial (Use 160646BZ Brush and 36422003 Agitator End)

### TWO BRUSH W/O BEATER BAR

H-48414021	Agitator (Molded Thread Guards)
------------	---------------------------------