

This Owner's Manual is provided and hosted by [Appliance Factory Parts](#).

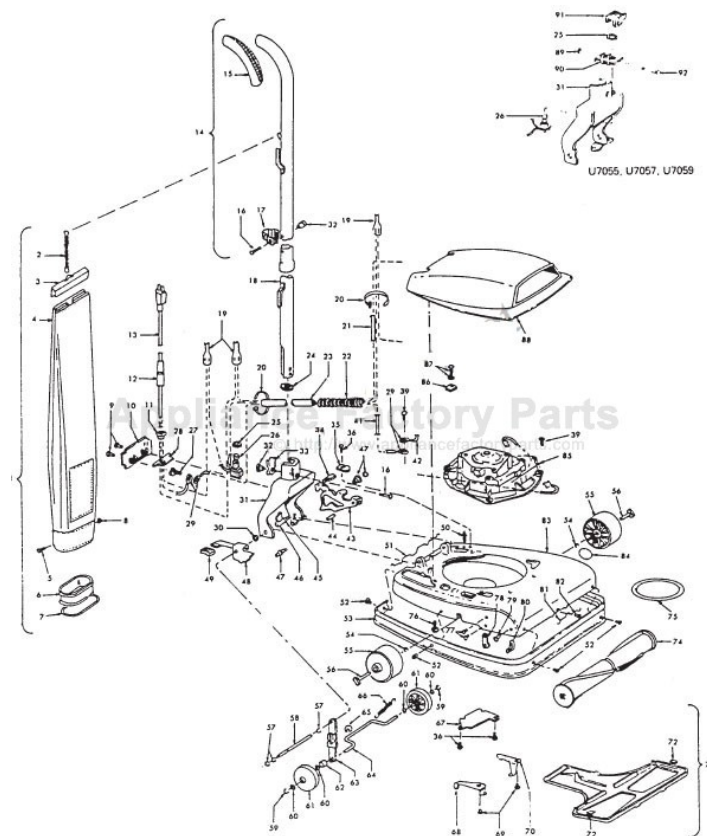

HOOVER U7059 Owner's Manual

[Shop genuine replacement parts for HOOVER U7059](#)



[Find Your HOOVER Vacuum Cleaner Parts - Select From 1456 Models](#)

----- Manual continues below part list -----

Available Replacement Parts for HOOVER U7059

H-44783	BELT, ROUND, 1PK
H-43267002	AGITATOR BEARING ASM
H-49258	ROUND CONVERTIBLE/DECADE BELT FOR HOOVER

HOOVER Original

INDUSTRIAL UPRIGHT

Models U7039, U7041, U7043, U7045, U7047, U7055, (220V), U7057, U7059

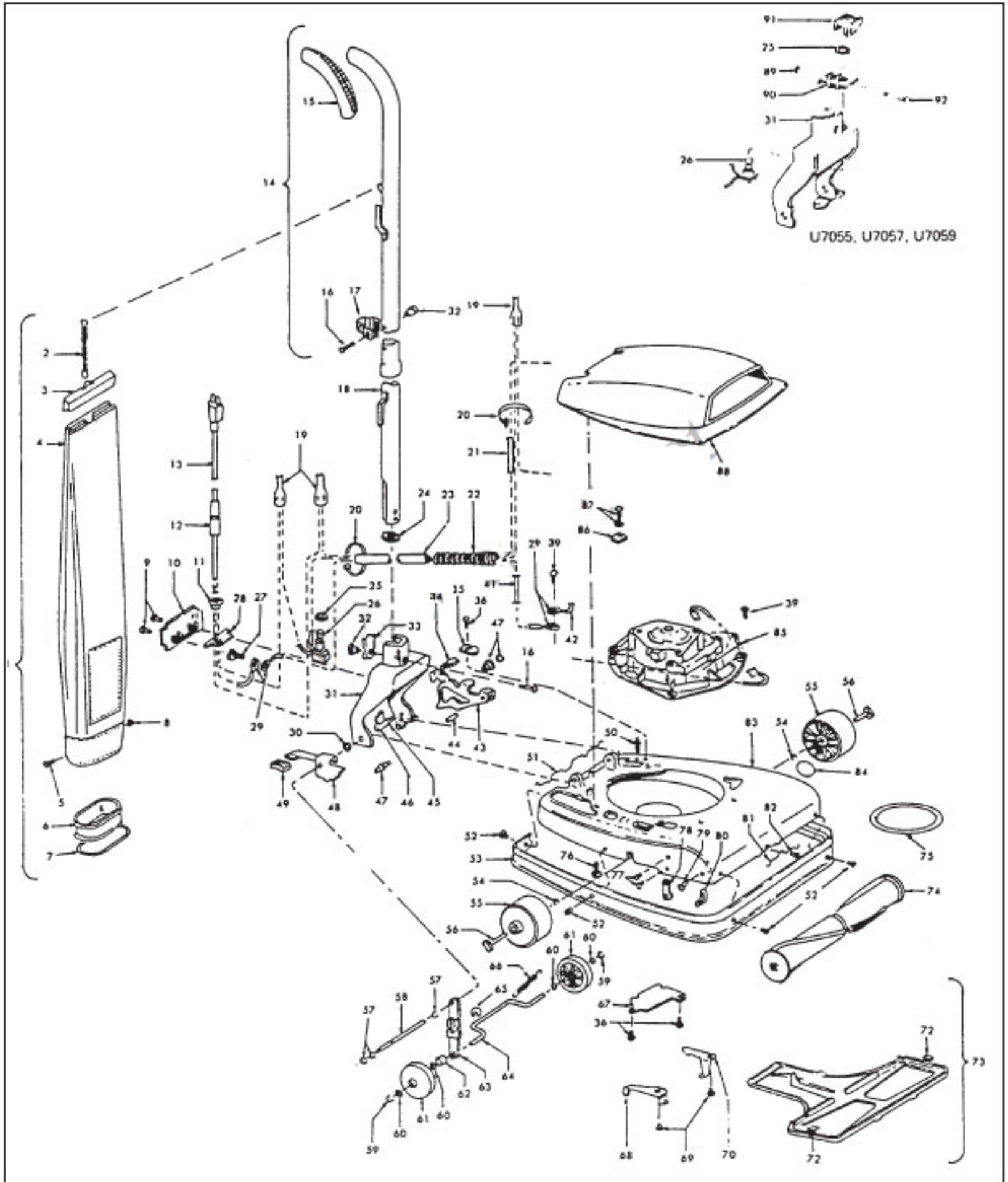

Original

HOOVER

INDUSTRIAL UPRIGHT

Models U7039, U7041, U7043, U7045, U7047, U7055 (220V), U7057, U7059

KEY	PART NO.	DESCRIPTION	KEY	PART NO.	DESCRIPTION
1	NLA	Outer Bag Comp. - Cloth	34	H-38426063	Foot Pad
2	H-44475 AW	Bag Support Spring	38	H-38426064	Foot Pad - U7055, U7057, U7059
3	NLA	Bag Closure Clip & Spring - U7039, U7041	35	H-34665007	Pivot Pin Retainer
	H-41424006	Bag Closure Clip & Spring - U7043, U7045, U7047, U7055, U7057, U7059	36	NLA	Machine Screw
4	NLA	Outer Bag - Cloth	39	H-45355	Machine Screw
5	H-15980	Screw - Machine	41	H-46214002	Lead Wire - Green
6	H-41424011	Bag Flange & Gasket - U7039, U7041	42	H-46128002	Jumper Lead - Green
	H-41424012	Bag Flange & Gasket	43	H-38456050	Handle Control Levor
7	H-47454	Bag Flange Gasket (use w/48961)	44	H-47450 AY	Pivot Pin
8	H-15854 EF	Nut - Special	45	H-48409 FW	Bag Flange Clamp Lever Spring
9	H-21481273	Screw - Self Tapping (2)	46	H-36153034	Bag Flange Clamp Lever
10	H-37954001	Bail Cover Plate	47	H-11735	Roller Detent Ass'y
11	H-165371	Strain Relief-U7039, U7041	48	NLA	Nozzle Adj. Lever
	H-39049	Strain Relief	49	H-38426071	Foot Pad
12	H-36215001	Cord Protector - U7043, U7045, U7047, U7055, U7057, U7059		NLA	Foot Pad - U7055, U7057, U7059
13	H-46583092	Attach. Cord - NM - 3W - 35'	50	H-12559 FW	Handle Control Lever Spring
	H-46583089	Attach. Cord - NM - 3W - 29' - 220V	51	NLA	Bag Flange Retaining Spring
	H-46583090	Attach. Cord - NM - 3W - 50' - 220V	52	H-32242004	Rivet - Tubular (6)
	H-46583095	Attach. Cord - NM - 3W - 50'	53	H-36231037	Furniture Guard - AG
14	NLA	Handle - Upper Half - AG - U7039, U7041, U7043, U7045, U7047 (Items 16, 17, 32 Not Included)	54	H-13730 FW	Lock Ring (2)
	NLA	Handle - Upper Half - AG - U7055, U7057, U7059	55	H-34791Y	Carrier Wheel (2)
15	H-23458 AG	Handle Grip	56	H-47103, *	Carrier Wheel Shaft (2)
16	H-48294 AW	Handle Bolt & Nut - U7039, U7041	57	H-130 FW	Lock Ring (3)
	H-21631302	Handle Bolt	58	H-16112 AY	Bail Shaft
17	H-14492	Cord Clamp - (Plastic) U7039, U7041	59	H-47107 AZ	Spring Lock Ring (2)
	H-34785015	Cord Retainer Clip Metal - AG)	60	H-4712772	Washer (4)
18	NLA	Handle - Lower Half - AG	61	H-33321041	Rear Wheel (2)
19	H-12227	Insulated Terminal (3)	57	H-31148004	Spacer
20	H-27479307	Lead Wire Tie	62	NLA	Cam Follower Ass'y
21	H-46213006	Lead Wire - White	64	H-33152003	Rear Wheel Shaft
22	H-38313023	Motor Lead Spring	65	H-34252005	Yoke
23	H-31727010	Cord Cover Tubing - AG	66	H-161513	Spring
24	H-37911035	Handle Plug	67	H-35434040	Axle/Bag Flange Retainer
25	H-12560	Switch Nut		H-34314002	Axle/Bag Flange Retainer - U7055
26	H-28212017	Switch	68	H-35446003	Bottom Plate Latch - R.H.
27	H-166735 EF	Screw - Self Tapping - U7039, U7041	69	H-12456	Rivet - Tubular (2)
	NLA	Screw - Sems	70	H-35446005	Bottom Plate Latch - L.H.
28	H-34223004	Strain Relief Mounting Plate	72	H-34111001	Support Pad (2)
29	H-27661503	Ring Tongue Terminal	73	H-42246008	Bottom Plate Ass'y
30	H-161507	Washer	74	NLA	Agitator Comp.
31	H-41416010	Bail - AG		H-48414003	Agitator - Four Brush - U7047, U7059
32	H-43294 AW	Handle Bolt & Nut - U7039, U7041	75	H-44783 AG	Belt
	H-32277008	Handle Nut	76	H-16903	Screw - Self Tapping (2) (Use on Hoods w/Capserts)
33	H-35463002	Handle Retainer Plate - AW		H-21447020	Screw - Self Tapping (Use on Hoods w/o Capserts)
			77	H-48422	Rivet - Tubular (4)
			78	H-47260 FW	Agitator Support Plate (2)
			79	NLA	Agitator Clamp Support Rivet (2)
			80	H-47259 AY	Agitator Clamp Spring (2)

HOOVER Original

INDUSTRIAL UPRIGHT

Models U7039, U7041, U7043, U7045, U7047, U7055 (220V), U7057, U7059

KEY	PART NO.	DESCRIPTION
81	NLA	Bottom Plate Spring
82	H-161882	Rivet - Tubular
83	H-42242058	Main Casting
84	NLA	Medallion
85	NLA	Motor Comp.-U7039, U7043, U7055 - 220V
	H-43574136	Motor Comp.-U7057, U7059, U7041, U7045, U7047 - 1 Spd.
86	H-34665007	Pivot Pin Retainer (2 Req.)
87	H-14279	Screw Ass'y
88	H-42251293	Hood - U7039, U7041, U7043, U7045, HU7047
	H-42251271	Hood - U70H55, U7057, U7059
89	H-24735022	Circlip - U7055, U7057, U7059
90	H-35217006	Mounting Bracket - AG - U7055, U7057, U7059
91	H-38424003	Switch Pedal - U7055, U7057, U7059
92	H-613802	Shaft - U7055, U7057, U7059

ITEMS NOT ILLUSTRATED

H-11064 JM	Bellows - U7039, U7041
H-13704	Lock Washer (Handle Bolt)
H-25084	Plug (3 Wire) - U7039, U7043, U7055
H-161869	Support Tube - U7039, U7D41
H-36215001	Cord Retainer - Formed (Bail) - U7055, U7057, U7059
H-36215002	Lead Wire Protector (Bail) - U7055, U7057, U7059
H-48646050	Handle Complete - U7039, U7041, U7043, U7045, U7047
H-48646034	Handle Complete - U7055, U7057, U7059

PACKAGING MATERIAL

H-58173039	Carton - Common
H-58343025	Front Support
H-58366012	Rear Support
H-56511054	Owner Manual - U7039, U7041
H-56511069	Owner Manual - U7043, U7D45
H-56511068	Owner Manual - U7047
H-56511113	Owner Manual - U7055, U7057
H-56511114	Owner Manual - U7059

Original **HOOVER** CONVERTIBLE & INDUSTRIAL CLEANER

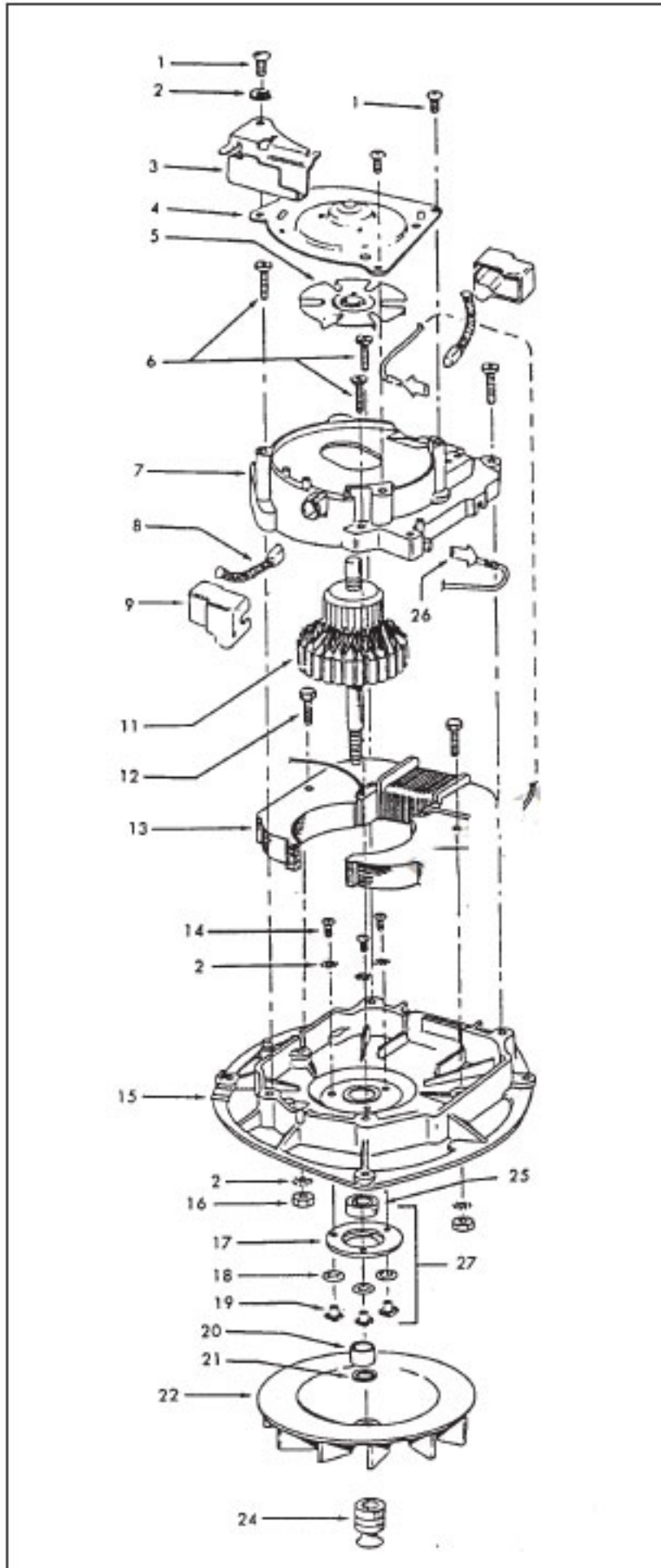

Motor H-43574128
1-Speed w/Guide

Motor H-43574130
1-Speed w/o Guide

KEY	PART NO.	DESCRIPTION
1	NLA	Screw
2	H-14062	* Washer
3	H-41961009	Indicator Guide
4	H-42934002	Upper Bearing
5	H-38755004	Vent Fan
6	H-161535	* Screw
7	NLA	Upper Motor Casing
8	H-47318012	Carbon Brush
9	H-14322	Brush Insulator
11	H-44765085	Armature Convertible
11	NLA	Armature Industrial
12	H-45118	Bolt
13	NLA	Field Coil
14	H-44779 AV	* Screw
15	H-42192024	Lower Motor Case
16	NLA	Nut
17	NLA	Retainer
18	H-19772	* Washer
19	H-45251	Nut
20	H-31731002	Spacer
21	H-166563	* Washer
22	H-38755010	Fan - Poly
	H-38532009	Motor Pulley Convertible
24	H-43251003	Motor Pulley Industrial
25	H-24152807	Bearing
26	H-14320	* Terminal
27	H-43267006	Bearing Kit 3 Hole
	NLA	Bearing Kit 4 Hole (Not Shown)

ITEMS NOT ILLUSTRATED

- H-35276006 Indicator Guide Spring
- H-31162004 Washer Heat Insulating
Between Pulley & Fan Conv.

NLA = No Longer Available

Original **HOOVER** CONVERTIBLE & INDUSTRIAL CLEANERS

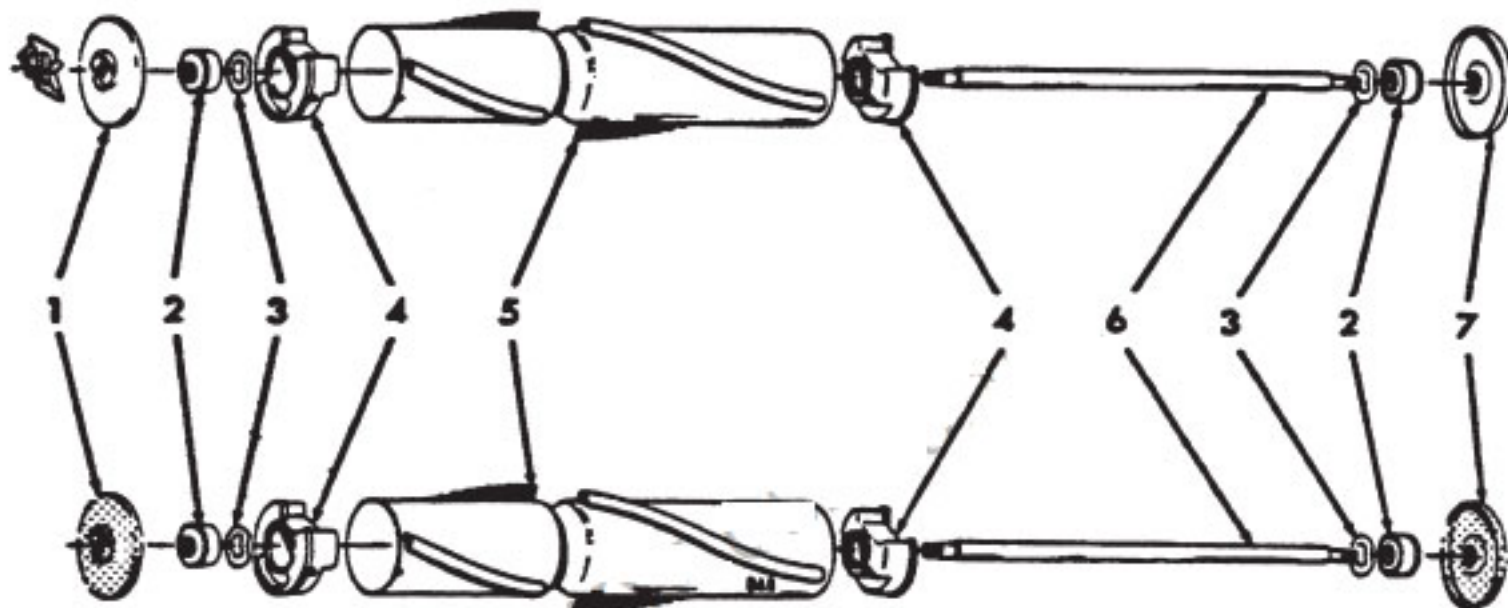
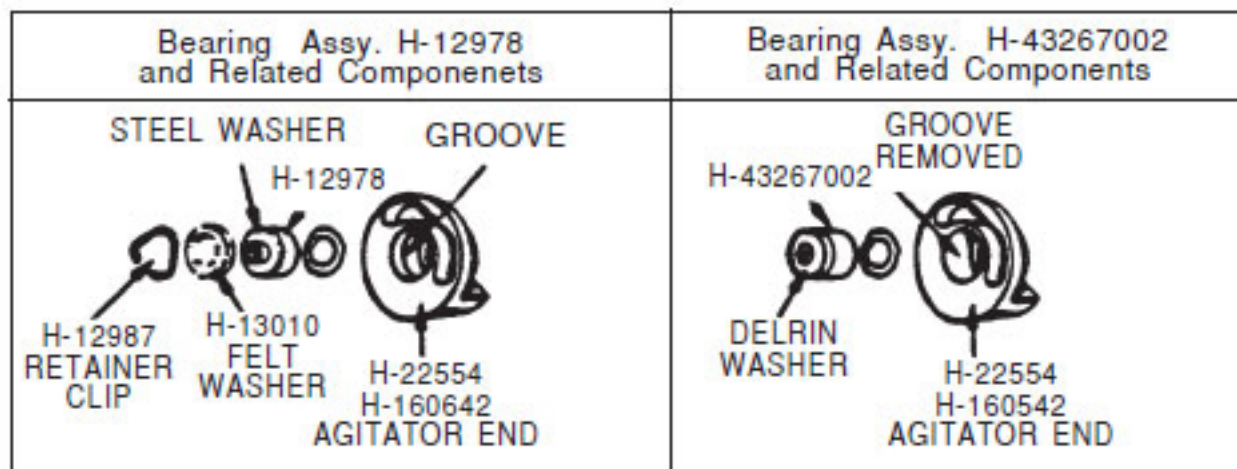

KEY	PART NO.	DESCRIPTION
1	H-49180	Thread Guard & Spring (Metal)
	NLA	Thread Guard L.H. (Molded)
2	H-43267002	Bearing
3	H-21347003	Washer
4	NLA	Agitator End (Early Model Standard Performance Cleaners, L.H. Helix)
4	H-160542	Agitator End (Standard & High Performance Cleaners, R.H. Helix)
4	H-41435070	Agitator End (Use w/two brush Agitator Pt. #48414021)
5	NLA	Agitator Brush-8 mil (Early Model Standard Performance Cleaners, L.H. Helix)
5	H-160646 BZ	Agitator Brush-8 mil (Standard Performance Cleaners, R.H. Helix)
5	H-48445001	Agitator Brush-11 mil (High Performance Cleaners, R.H. Helix)
6	NLA	Agitator Shaft (Used w/metal thread guards)
6	H-32724008	Agitator Shaft (Used w/Molded thread guards)
7	H-12985 AY	Thread Guard R.H. (Metal)
	NLA	Thread Guard R.H. (Molded)

AGITATOR BELT

H-49258	Domestic Models, Convertible/ Decade 80/Heavy Duty Commercials
H-44783	Lightweight Commercials

KEY	PART NO.	DESCRIPTION
AGITATOR ASSEMBLY		
	NLA	Standard Performance, R.H. Helix (Metal Thread Guards)
	NLA	High Performance Cleaners, R.H. Helix (Molded Thread Guards)
	NLA	Standard Performance, R.H. Helix (Molded Thread Guards)

FOUR BRUSH AGITATOR ASSEMBLY

NLA	Heavy Duty Commercial (Use 47159 Brush - Long, 47160 Brush - Short and 46875 Sems Fastener)
H-48414003	Lightweight Commercial (Use 160646BZ Brush and 36422003 Agitator End)

TWO BRUSH W/O BEATER BAR

H-48414021	Agitator (Molded Thread Guards)
------------	---------------------------------