

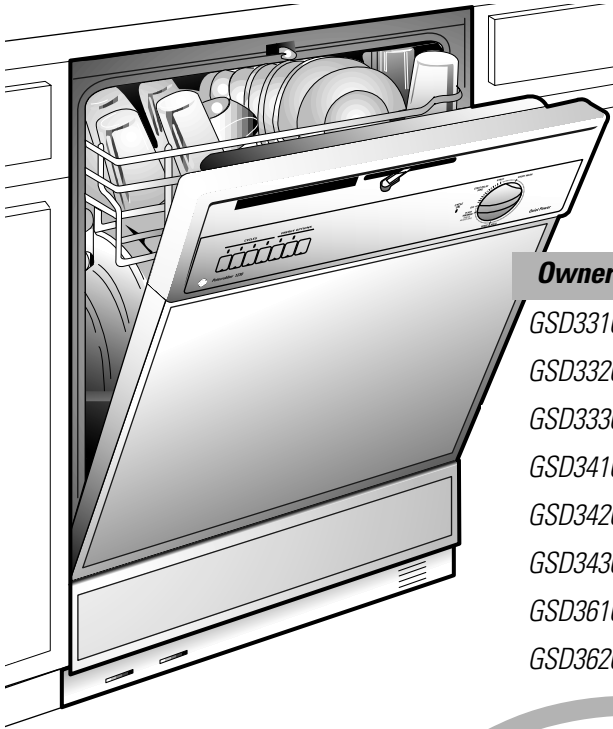

GE Appliances

Dishwashers



Owner's Manual

- GSD3310 GSD3630
- GSD3320 GSD3810
- GSD3330 GSD3820
- GSD3410 GSD3830
- GSD3420 GSD3910
- GSD3430 GSD3920
- GSD3610 GSD3930
- GSD3620



GE Answer Center® 800.626.2000

Part No. 165D4700P195 Pub. No. 49-5870 6-99 JR

Congratulations! You Are Now Part of the GE Family.

Welcome to the GE family. We're proud of our quality products and we are committed to providing dependable service. You'll see it in this easy-to-use Owner's Manual and you'll hear it in the friendly voices of our customer service department.

Best of all, you'll experience these values each time you use your dishwasher. That's important, because your new dishwasher will be part of your family for many years. And we hope you will be part of ours for a long time to come.

We thank you for buying GE. We appreciate your purchase, and hope you will continue to rely on us whenever you need quality appliances for your home.



Important!

Fill out and return the Consumer Product Ownership Registration card that is packed with this product. If you cannot find it, please send in the duplicate card printed in the back of this manual.

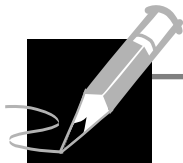

Write the model and serial numbers here.

You can find them on the tub wall just inside the door.

Staple sales slip or cancelled check here.

Proof of the original purchase date is needed to obtain service under the warranty.

GE & You, A Service Partnership.

Ask any GE appliance owner and they will tell you we stand behind our products with unmatched quality service. However, did you know that most questions result from simple problems that you can easily fix yourself in just a few minutes? This Owner's Manual can tell you how.



Read this Manual

Inside you will find many helpful hints on how to use and maintain your dishwasher properly. Just a little preventive care on your part can save you a great deal of time and money over the life of your dishwasher.



Review the Section on Troubleshooting Tips

You'll find many answers to common problems here. If you review our chart of Troubleshooting Tips first, you may not need to call for service at all.



If You Need Service

If you do need service, you can relax knowing help is only a phone call away. A list of toll-free customer service numbers is included in the back section. Or you can always call the GE Answer Center® at 800.626.2000, 24 hours a day, 7 days a week.

Safety Information4-7

Safety Information

Operating Instructions

Control Panel	8
Control Settings	9
Dial Cycles	10-11
Using the Dishwasher . . .	12, 13
Loading the Dishwasher Racks	14, 15
Care and Cleaning	16, 17
Optional Accessories	18

Operating Instructions

Troubleshooting Tips

Before You Call For Service	19-24
---------------------------------------	-------

Troubleshooting Tips

Customer Service

Product Registration	29
Warranty	31
Service Telephone Numbers	Back Cover

Customer Service

IMPORTANT SAFETY INFORMATION. READ ALL INSTRUCTIONS BEFORE USING.

⚠ WARNING!

For your safety, the information in this manual must be followed to minimize the risk of fire, explosion, electric shock, or to prevent property damage, personal injury, or loss of life.

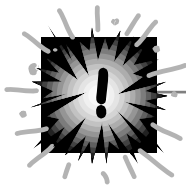

WATER HEATER SAFETY

*Under certain conditions hydrogen gas may be produced in a water heater that has not been used for two weeks or more. **HYDROGEN GAS IS EXPLOSIVE.***

If the hot water has not been used for two weeks or more, prevent the possibility of damage or injury by turning on all hot water faucets and allow them to run for several minutes. Do this before using any electrical appliance which is connected to the hot water system. This simple procedure will allow any built-up hydrogen gas to escape. Since the gas is flammable, do not smoke or use an open flame or appliance during this process.

Use your dishwasher only for its intended purpose as described in this Owner's Manual.

PROPER INSTALLATION AND MAINTENANCE



This dishwasher must be properly installed and located in accordance with the Installation Instructions before it is used. If you did not receive an Installation Instructions sheet with your dishwasher, you can receive one by calling us toll-free at the GE Answer Center[®], 800.626.2000.

- Connect to a grounded metal, permanent wiring system; or run an equipment-grounding conductor with the circuit conductors and connect to the equipment-grounding terminal or lead of the appliance.
- Improper connection of the equipment-grounding conductor can result in a risk of electric shock. Check with a qualified electrician or service representative if you are in doubt whether the appliance is properly grounded.
- Dispose of discarded appliances and shipping or packing material properly.
- Do not attempt to repair or replace any part of your dishwasher unless it is specifically recommended in this manual. All other servicing should be referred to a qualified technician.
- To minimize the possibility of electric shock, disconnect this appliance from the power supply before attempting any maintenance. **NOTE:** Turning the dishwasher off does not disconnect the appliance from the power supply. We recommend having a qualified technician service your appliance.

IMPORTANT SAFETY INFORMATION. READ ALL INSTRUCTIONS BEFORE USING.

⚠ WARNING!



DO NOT...

- Do not tamper with controls.
- Do not abuse, sit on, or stand on the door or dish rack of the dishwasher.
- Do not discard a dishwasher without first removing the door of the washing compartment.
- Do not store or use combustible materials, gasoline or other flammable vapors and liquids in the vicinity of this or any other appliance.
- Do not allow children to play inside, on or with this appliance or any discarded appliance.

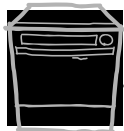

WHEN USING YOUR DISHWASHER

- Use only powder, tabs or liquid detergents or wetting agents recommended for use in a dishwasher and keep them out of the reach of children. Cascade® Automatic Dishwashing Detergent has been approved for use in all GE dishwashers.
- Locate sharp items so that they are not likely to damage the door seal.
- Load sharp knives with the handles up to reduce the risk of cut-type injuries.
- Do not wash plastic items unless marked *dishwasher safe* or the equivalent. For plastic items not so marked, check the manufacturer's recommendations.
- Non-Dishware Items: Do not wash items such as electronic air cleaner filters, furnace filters and paint brushes in your dishwasher. Damage to dishwasher and discoloration or staining of dishwasher may result.
- Do not touch the heating element during or immediately after use.
- Do not operate your dishwasher unless all enclosure panels are properly in place.
- Close supervision is necessary if this appliance is used by or near children.
- Load light plastic items so they will not become dislodged and drop to the bottom of the dishwasher—they might come into contact with the heating element and be damaged.

*Read and follow this
Safety Information carefully.*

SAVE THESE INSTRUCTIONS



About the dishwasher control panel.

You can locate your model number on the tub wall just inside the door. Throughout this manual, features and appearance may vary from your model.

Models GSD3310, GSD3320 and GSD3330

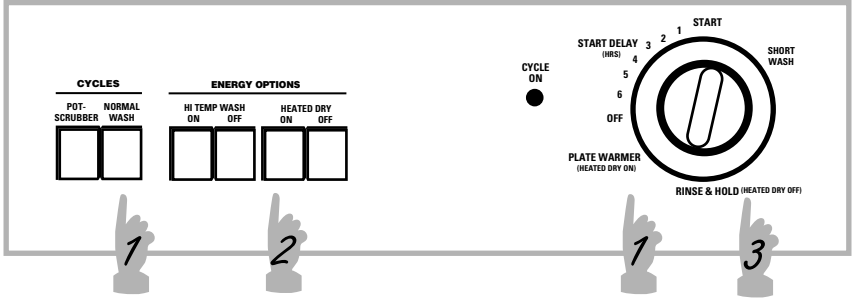

Models GSD3410, GSD3420 and GSD3430

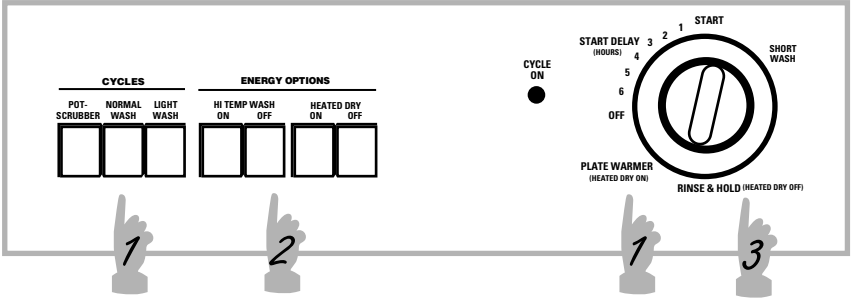

Models GSD3610, GSD3620 and GSD3630

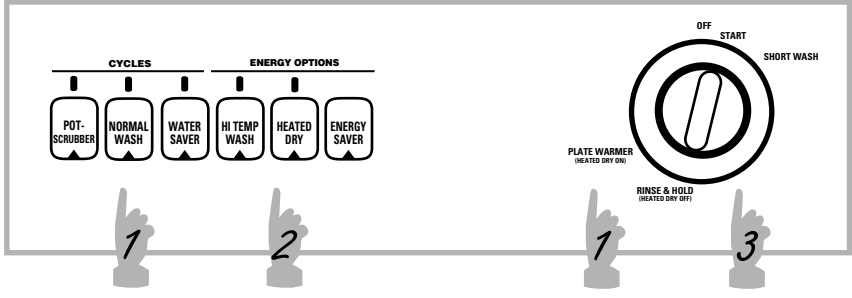

Models GSD3810, GSD3820, GSD3830, GSD3910, GSD3920 and GSD3930

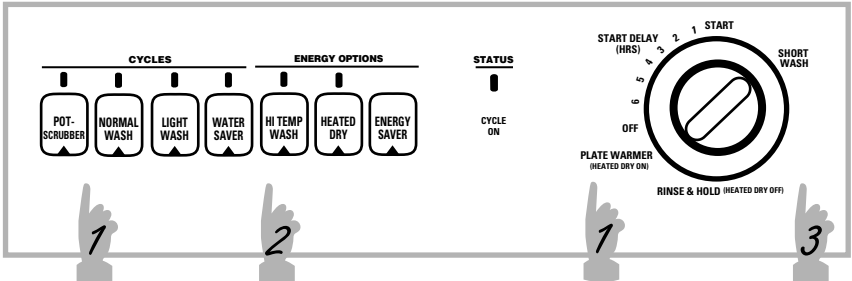



Control Settings



Cycles

POTSCRUBBER For heavily soiled dishes or cookware with dried-on or baked-on soils. Everyday dishes may be included. This cycle will not remove burned-on foods.

NORMAL WASH For loads of everyday dishes, glasses and cookware with medium soils. **NOTE:** Many dishes have lighter soil than normal. Choosing a cycle other than **NORMAL WASH** will save energy and water.

**LIGHT WASH/
WATER SAVER** For dishes with light soils.

SHORT WASH For quickly washing loads of everyday dishes with medium soils that have not dried on, such as loads consisting mostly of glasses.

RINSE & HOLD For rinsing partial loads that will be washed later. *Do not use detergent.*

PLATE WARMER For warming clean dishes and serving plates. This cycle will take approximately 32 minutes.

- Make sure the Dial is at the **OFF** position.
- Latch the door.
- **NOTE:** The lights over the pads come on when pressed, to indicate the cycle/option that has been selected. Press pad firmly until lights come on. These lights remain on while the door is locked.



Energy Options

**HI TEMP
WASH** Provides extra heat for best performance. It is used best with heavily-soiled dishes.

**HEATED DRY ON/
HEATED DRY** Turns the drying heater on for fast drying. This cycle will extend the time to your wash cycle.

HEATED DRY OFF Shuts off the drying heat option. Dishes air dry naturally and energy is saved.

ENERGY SAVER Turns all **ENERGY OPTIONS** off.

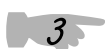

Start

Slowly turn the Dial to the **START** position. Don't turn it past the **START** position, or you could accidentally miss a rinse. There is a time delay between start-up and water fill so you will not hear any wash action right away.

About the dial cycles.

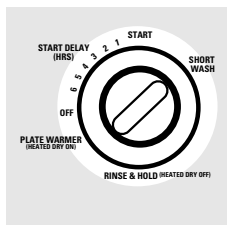

Short Wash

For quickly washing loads of everyday dishes with medium soils that have not dried on.

- 1 Select the **NORMAL WASH** cycle and any options.
- 2 Be sure the door is unlatched.
- 3 Slowly turn the Dial to **SHORT WASH**.
- 4 Latch the door to start the cycle.

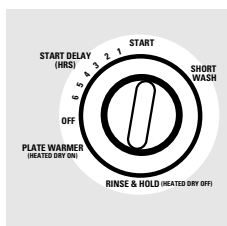

Rinse & Hold

For rinsing partial loads that will be washed later. *Do not use detergent.*

- 1 Make sure **HEATED DRY** is not selected.
- 2 Be sure the door is unlatched.
- 3 Slowly turn the Dial to **RINSE & HOLD**.
- 4 Latch the door to start the cycle.

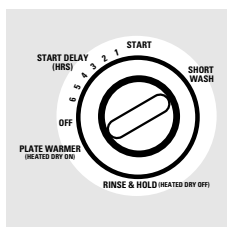
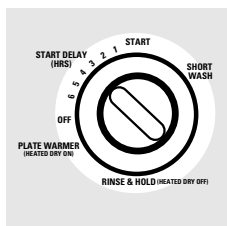

Plate Warmer

For warming clean dishes and serving plates. This cycle will take approximately 32 minutes.

- 1 Load clean dishware to be warmed.
- 2 Select **HEATED DRY**.
- 3 Be sure the door is unlatched.
- 4 Slowly turn the Dial to **PLATE WARMER**.
- 5 Latch the door to start the cycle.



Start Delay (GSD3310, GSD3320, GSD3330, GSD3410, GSD3420, GSD3430, GSD3810, GSD3820, GSD3830, GSD3910, GSD3920 and GSD3930 only)

The **START DELAY** will allow you to delay the start time of any cycle not on the Dial automatically for up to 6 hours.

- 1 Be sure the door is unlatched.
- 2 Select the wash cycle and option you want.
- 3 Slowly turn the Dial to desired time. The **CYCLE ON** light will come on.
- 4 Latch the door to start the cycle.

About the cycle sequence. *(Not all cycles are on all models)*

Models GSD3310, GSD3320, GSD3330, GSD3410, GSD3420, GSD3430, GSD3610, GSD3620 and GSD3630

<i>Cycles</i>	<i>Water (approx.)</i>	<i>Time (approx.)</i>	<i>Cycle Sequence</i>						
POTSCRUBBER	9.5 gal.	63 min.	Rinse	Rinse	Rinse	Main Wash	Rinse	Rinse	Rinse
NORMAL WASH	8.0 gal.	63 min.		Rinse	Rinse	Main Wash	Rinse	Rinse	Rinse
LIGHT WASH	6.7 gal.	63 min.			Rinse	Rinse	Main Wash	Rinse	Rinse
WATER SAVER	5.4 gal.	63 min.		Rinse	Rinse	Main Wash	Rinse	Rinse	
SHORT WASH	6.6 gal.	55 min.		Rinse	Main Wash	Rinse	Rinse	Rinse	
RINSE & HOLD	3.9 gal.	12 min.						Rinse	Rinse

Models GSD3810, GSD3820, GSD3830, GSD3910, GSD3920 and GSD3930

<i>Cycles</i>	<i>Water (approx.)</i>	<i>Time (approx.)</i>	<i>Cycle Sequence</i>						
POTSCRUBBER	9.3 gal.	63 min.	Rinse	Rinse	Rinse	Main Wash	Rinse	Rinse	Rinse
NORMAL WASH	8.0 gal.	63 min.		Rinse	Rinse	Main Wash	Rinse	Rinse	Rinse
LIGHT WASH	6.7 gal.	63 min.			Rinse	Rinse	Main Wash	Rinse	Rinse
WATER SAVER	5.4 gal.	63 min.		Rinse	Main Wash	Rinse	Rinse		
SHORT WASH	6.6 gal.	55 min.		Rinse	Main Wash	Rinse	Rinse	Rinse	
RINSE & HOLD	2.6 gal.	9 min.						Rinse	Rinse

Drying Options:

HEATED DRY ON or HEATED DRY. Available on all wash cycles except **RINSE & HOLD**. Add approximately 32 minutes to the cycle.

ENERGY SAVER or HEATED DRY OFF. Drying heater is turned off. Dishes dry naturally.

Using the dishwasher.



Check the Water Temperature

The entering water must be at least 120°F. and not more than 150°F., for effective cleaning and to prevent dish damage. Check the water temperature with a candy or meat thermometer. Turn on the hot water faucet nearest the dishwasher, place the thermometer in a glass and let the water run continuously into the glass until the temperature stops rising.



Use Jet-Dry® Rinse Agent

Jet-Dry® rinse agent removes spots and prevents new film build-up on your dishes, glasses, flatware, cookware and plastic.

Fill the rinse agent dispenser until it reaches the bottom of lip inside the opening. Replace cap.

To check if rinse agent is needed, remove the cap and look into the dispenser. On some models, the dispenser can be checked by pressing the clear center of the fill cap 2 or 3 times. If rinse agent fills the center of the fill cap, you have enough.

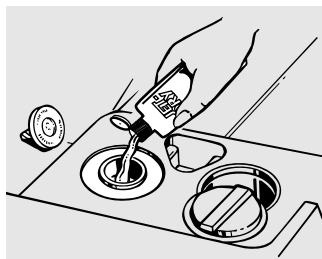

A full dispenser should last about one month.

If rinse agent spills, wipe up the excess.

Dish Preparation Prior to Loading

- No pre-rinsing of normal food soil is required.
- Scrape off hard soils including bones, toothpicks, skins, and seeds.
- Remove large quantities of any remaining food.
- Remove leafy vegetables, meat trimmings, and excessive amounts of grease or oil.
- Remove acidic food soils that can discolor stainless steel.

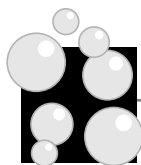

Proper Use of Detergent

Use only detergent specifically made for use in dishwashers. Cascade® Automatic Dishwashing Detergent has been approved for use in all GE dishwashers. Keep your detergent fresh and dry. Don't put powder detergent into the dispenser until you're ready to wash dishes.

The amount of detergent to use depends on whether your water is *hard* or *soft*. With hard water, you need extra detergent. With soft water, you need less detergent.

Protect your dishes and dishwasher by contacting your water department and asking how hard your water is. Twelve or more grains is extremely hard water. A water softener is recommended. Without it, lime can build up in the water valve, which could stick while open and cause flooding. Too much detergent with soft water can cause a permanent cloudiness of glassware, called *etching*.

You'll find two detergent dispensers on the inside door of your dishwasher. All wash cycles require detergent in the main cup. Wash cycles with two washes will also use the open cup. When using automatic dishwashing detergent tabs, simply place one tab in the main cup and close.

Be sure the Dial is **OFF** before adding detergent. Otherwise, the detergent cup will not close and latch properly. Add detergent then close the main cup.

NOTE: To open detergent cup after it has been closed, simply turn the detergent cup handle counter-clockwise until it releases. A snapping sound may be heard.

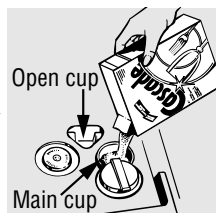

Forget to Add a Dish?

A forgotten dish can be added any time before the main wash.

- 1 Push the door latch to the left.
- 2 Once the water calms, open the door. Steam may rise out of the dishwasher.
- 3 Add forgotten dishes.
- 4 Close the door and push the latch to the far right.

Loading the dishwasher racks.

For best dishwashing results, follow these loading guidelines. Features and appearance of racks and silverware baskets may vary from your model.

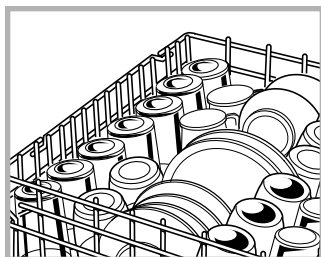

Upper Rack

The upper rack is for glasses, cups and saucers. Cups and glasses fit best along the sides. This is also a secure place for dishwasher-safe plastics. The upper rack is good for all kinds of odd-shaped utensils. Saucepans, mixing bowls and other items should be placed face down.

A *wine glass holder* (on some models) secures wine glasses at an angle for best washability. Because wine glasses come in various sizes, after loading, slowly push in the rack to make sure they will clear the top of the dishwasher.

Secure larger dishwasher-safe plastics over two fingers when possible.

Make sure small plastic items are secure so they can't fall onto the heating element.

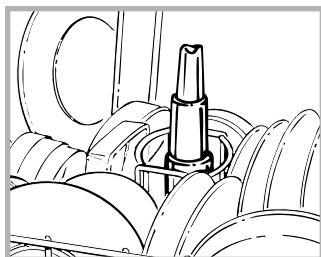
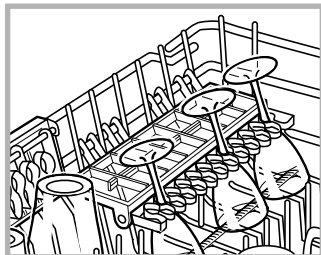

The Wash Tower

Keep the center area clear in the lower rack.

The wash tower rises through the center of the lower rack during the wash and rinse portions of the cycle.

A *second wash tower* is located in the top rack. Water from the wash tower in the lower rack shoots up into this wash tower and out the openings at the top. When loading items around this wash tower do not block the top openings.



Don't block it or load tall things next to it.

Also, be careful not to let a portion of an item such as a pot or dish handle extend through the bottom rack. This could block the wash arm and cause poor washing results.

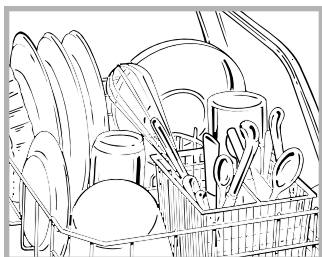

Lower Rack

When loading the lower rack, do not load large platters or trays in the front right corner. They may prevent detergent from circulating during the wash cycle.

The lower rack is best used for plates, saucers, and cookware. Large items such as broiler pans and racks should go along the sides. Load platters, pots and bowls along the sides, in corners, or in the back. The soiled side of items should face the center of the rack.



Don't let any item extend through bottom.

Single basket (on some models)

Silverware Basket

Put flatware in the removable basket with fork and knife handles up to protect your hands. Place spoons in the basket with handles down. Mix knives, forks and spoons so they don't nest together. Distribute evenly. Small plastic items, such as measuring spoons and lids from small containers, should go in the bottom of the silverware basket with silverware on top.

To increase the flexibility of the lower rack, the silverware basket may be split (on some models). Grasp the basket at opposite corners and slide apart. The basket sections should be placed in the lower rack by hanging them on the top hoop.



Split basket (on some models)

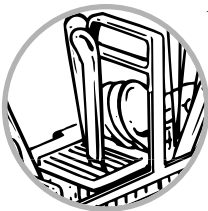

A cover can be lowered to either side to secure lightweight items from the effects of the vigorous wash action.

Caring for the dishwasher.

To clean the control panel use a lightly dampened cloth then dry thoroughly. To clean the exterior use a good appliance polish wax.

Never use sharp objects, scouring pads or harsh cleaners on any part of the dishwasher.

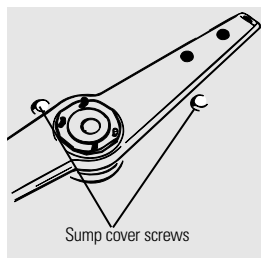

Protect Against Freezing

If your dishwasher is left in an unheated place during the winter, ask a service technician to:

- 1 Cut off electrical power to the dishwasher. Remove fuses or trip circuit breaker.
- 2 Turn off the water supply and disconnect the water inlet line from the water valve.
- 3 Drain water from the inlet line and water valve. (Use a pan to catch the water.)
- 4 Reconnect the water inlet line to the water valve.
- 5 Remove the plastic sump cover in the tub bottom and use a sponge to soak up water in the rubber boot.

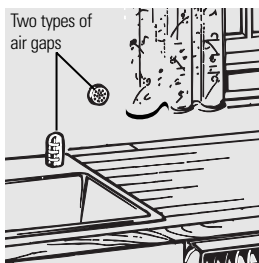

Check the air gap any time your dishwasher isn't draining well.

Does Your Dishwasher Have an Air Gap?

An air gap protects your dishwasher against water backing up into it if a drain clogs. The air gap is not a part of the dishwasher. It is not covered by your warranty. Not all plumbing codes require air gaps, so you may not have one.

The air gap is easy to clean.

- 1** Turn off the dishwasher and lift off the chrome cover.
- 2** Unscrew the plastic cap and clean with a toothpick.

About optional accessories.

You can change the door and lower access panel appearance of your dishwasher by ordering one of these optional accessories:

- Color Panels
- 1/4" Wood Panel Trim Kit
- 3/4" Trimless Panel Kit

These accessories are available at extra cost (VISA, MasterCard, or Discover cards accepted) by calling 800-626-2002.

Specify accessory number when ordering.



Descriptions of Optional Accessories

Color panels—Replacement door panels and lower access panels are available in the following colors:

- GPF300A (Almond)
- GPF300B (Black)
- GPF300W (White)

Wood panel trim kit—This accessory contains *trim and instructions* for you to supply and install a 1/4" thick decorative wood door and lower access panel:

- GPF325A (Almond)
- GPF325B (Black)
- GPF325W (White)

NOTE: The **GPF100 dishwasher door spring kit** must also be ordered and installed *when the door panel weighs four lbs. or more.*

Trimless panel kit—This accessory contains *parts and instructions* for you to supply and install a 3/4" thick decorative wood door and lower access panel:

- GPF375

NOTE: The **GPF100 dishwasher door spring kit** will be included with the *trimless panel kit* and must be installed with it.

Before you call for service...



Troubleshooting Tips

Review the charts on the following pages first and you may not need to call for service.

Problem	Possible Causes	What To Do
Dishwasher won't run	Fuse is blown, or the circuit breaker tripped	<ul style="list-style-type: none">• Replace fuse or reset circuit breaker. Remove any other appliances from the circuit.
Noise	Some of the sounds you'll hear are normal	<ul style="list-style-type: none">• Soft food disposal shredding action.• Drain valve opening to pump water out.• Timer control as cycle progresses.• Detergent cup opening.• The motor stopping during the drying period.
	Utensils are not secure in the rack or something small has dropped into the rack	<ul style="list-style-type: none">• Make sure everything is secured in dishwasher.
	Motor hums	<ul style="list-style-type: none">• Dishwasher has not been used on a regular basis. If you do not use your dishwasher often, set it to fill and pump out once every week. This will help keep the seal moist and the garbage disposer clear.

Before you call for service...



Troubleshooting Tips

Problem	Possible Causes	What To Do
Water standing in the bottom of the tub	This is normal	<ul style="list-style-type: none"> • A small amount of clean water around the outlet on the tub bottom at the back of the tub keeps the water seal lubricated.
Water won't pump out of the tub	Drain is clogged	<ul style="list-style-type: none"> • If you have an air gap, clean it. • Check to see if your kitchen sink is draining well. If not, you may need a plumber. • If the dishwasher drains into a disposer, run disposer clear.
Suds in the tub	Correct detergent wasn't used	<ul style="list-style-type: none"> • Use only automatic dishwasher detergents to avoid sudsing. Cascade® Automatic Dishwashing Detergent has been approved for use in all GE dishwashers. • To remove suds from the tub, open the dishwasher and let suds evaporate. Add 1 gallon of cold water to the tub. Close and latch the dishwasher. Pump out water by slowly turning the Dial until a drain period is reached. Repeat if necessary.
	Rinse agent was spilled	<ul style="list-style-type: none"> • Always wipe up rinse agent spills immediately.

Problem	Possible Causes	What To Do
Stained tub interior	Detergent with colorant was used	<ul style="list-style-type: none"> Some detergents contain colorant (pigment or dyes) that will discolor the tub interior with extended use. Check the detergent cup for signs of any discoloration. If cup is discolored, change to detergent without any colorant. Cascade® Automatic Dishwashing Detergent has been approved for use in all GE dishwashers.
	Some tomato-based foods can stain	<ul style="list-style-type: none"> Use of the RINSE & HOLD cycle (on some models) after adding the dish to the load can decrease the level of staining.
Dishes don't dry	Low inlet water temperature	<ul style="list-style-type: none"> Make sure inlet water temperature is correct.
	Rinse agent dispenser is empty	<ul style="list-style-type: none"> Check the rinse agent dispenser.
Dishes and flatware not clean	Inlet water temperature is below 120°F	<ul style="list-style-type: none"> Raise the water heater temperature to 120°F.
	Water pressure is temporarily low	<ul style="list-style-type: none"> Turn on a faucet. Is water coming out more slowly than usual? If so, wait until pressure is normal before using your dishwasher.
	Air gap is clogged	<ul style="list-style-type: none"> Clean the air gap.
	Improper rack loading	<ul style="list-style-type: none"> Make sure large dishware does not block the detergent dispenser or the wash arm.

Before you call for service...



Troubleshooting Tips

Problem	Possible Causes	What To Do
Spots and filming on glasses and flatware	<p>Extremely hard water</p> <p>Low inlet water temperature</p> <p>Overloading the dishwasher</p> <p>Improper loading</p> <p>Old or damp powder detergent</p> <p>Rinse agent dispenser empty</p> <p>Too little detergent</p>	<ul style="list-style-type: none"> • Use Jet-Dry® rinse agent to remove spots and prevent new film build-up. • To remove stubborn spots and pre-existing film from glassware: <ol style="list-style-type: none"> 1 Remove all metal utensils from the dishwasher. 2 Do not add detergent. 3 Select the longest cycle. 4 Start the dishwasher and allow to run for 18 to 22 minutes. Dishwasher will now be in the main wash. 5 Open the door and pour 2 cups (500 ml) of white vinegar into the bottom of the dishwasher. 6 Close the door and allow to complete the cycle. If vinegar rinse doesn't work: Repeat as above, except use 1/4 cup (60 ml) of citric acid crystals instead of vinegar.
Cloudiness on glassware	<p>Combination of soft water and too much detergent</p> <p>Water temperature entering the dishwasher exceeds 150°F</p>	<ul style="list-style-type: none"> • This is called <i>etching</i> and is permanent. To prevent this from happening, use less detergent if you have soft water. Wash glassware in the shortest cycle that will get them clean. • Lower the water heater temperature.

Problem	Possible Causes	What To Do
Yellow or brown film on tub	Tea or coffee stains	<ul style="list-style-type: none"> Remove the stain by hand, using a solution of 1/2 cup bleach and 3 cups warm water. <p>▲ WARNING Before cleaning interior, wait at least 20 minutes after a cycle for the heating element to cool down. Failure to do so can result in burns.</p>
	An overall yellow or brown film can be caused by iron deposits in water	<ul style="list-style-type: none"> A special filter in the water supply line is the only way to correct this problem. Contact a water softener company.
White film on inside surfaces	Hard water minerals	<ul style="list-style-type: none"> To clean the interior, apply dishwasher detergent to a damp sponge. Wear rubber gloves. Do not use any type of cleanser other than dishwasher detergent because it may cause foaming or sudsing. Cascade® Automatic Dishwashing Detergent has been approved for use in all GE dishwashers.

Before you call for service...



Troubleshooting Tips

Problem	Possible Causes	What To Do
Detergent cup lid won't latch	Dial is not in the OFF position	<ul style="list-style-type: none"> • Turn the Dial to OFF and slide the door latch to the left.
Detergent left in dispenser cups	Dishes are blocking the detergent cups	<ul style="list-style-type: none"> • Reposition the dishes.
Steam	This is normal	<ul style="list-style-type: none"> • Steam comes through the vent by the door latch during drying and when water is being pumped out.
Black or gray marks on dishes	Aluminum utensils have rubbed against dishes	<ul style="list-style-type: none"> • Remove marks with a mild, abrasive cleaner.
Cycle and Energy Option indicator lights stay on when cycle is completed	This is normal	<ul style="list-style-type: none"> • Unlock the door to turn off the Cycle and Energy Option indicator lights. <p>NOTE: The CYCLE ON light will stay on until all cycles are complete. Wait until this light goes off to unlock the door or a cycle will be interrupted.</p>

Notes

Safety Information

Operating Instructions

Troubleshooting Tips

Customer Service

Notes

Safety Information

Operating Instructions

Troubleshooting Tips

Customer Service

Customer Service

Troubleshooting Tips

Operating Instructions

Safety Information

Notes

GE Service Protection Plus™

GE, a name recognized worldwide for quality and dependability, offers you Service Protection Plus™—comprehensive protection on all your appliances—**No Matter What Brand!**

Benefits Include:

- Backed by GE
- All brands covered
- Unlimited service calls
- All parts and labor costs included
- No out-of-pocket expenses
- No hidden deductibles
- One 800 number to call

***We'll Cover Any Appliance.
Anywhere. Anytime.****

You will be completely satisfied with our service protection or you may request your money back on the remaining value of your contract. No questions asked. It's that simple.

Protect your refrigerator, dishwasher, washer and dryer, range, TV, VCR and much more—**any brand!** Plus there's no extra charge for emergency service and low monthly financing is available. Even icemaker coverage and food spoilage protection is offered. You can rest easy, knowing that all your valuable household products are protected against expensive repairs.

Place your confidence in GE and call us in the U.S. toll-free at **800-626-2224** for more information.

*All brands covered, up to 20 years old, in the continental U.S.



Please place in envelope and mail to:

General Electric Company
Warranty Registration Department
P.O. Box 34070
Louisville, KY 40232-4070

Consumer Product Ownership Registration

Dear Customer:

Thank you for purchasing our product and thank you for placing your confidence in us. We are proud to have you as a customer!

Follow these three steps to protect your new appliance investment:

1

Complete and mail your Consumer Product Ownership Registration today. Have the peace of mind of knowing we can contact you in the unlikely event of a safety modification.

2

After mailing the registration below, store this document in a safe place. It contains information you will need should you require service. Our service number is 800-GE-CARES (800-432-2737).

3

Read your Owner's Manual carefully. It will help you operate your new appliance properly. If you have questions, or need more information call the GE Answer Center® 800.626.2000.

Model Number

Serial Number

Important: If you did not get a registration card with your product, detach and return the form below to ensure that your product is registered.

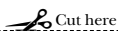

Consumer Product Ownership Registration

Model Number

Serial Number

Mr. Ms. Mrs. Miss

First Name

Last Name

Street Address

Apt. #

City

State Zip Code

Date Placed In Use
Month Day Year

Phone Number - -



GE Appliances

HOTPOINT

GE Dishwasher Warranty



All warranty service provided by our Factory Service Centers, or an authorized Customer Care[®] technician. For service, call 800-GE-CARES.

For The Period Of:	GE Will Replace:
One Year From the date of the original purchase	Any part of the dishwasher which fails due to a defect in materials or workmanship. During this full one-year warranty , GE will also provide, free of charge , all labor and in-home service to replace the defective part.
Second Year From the date of the original purchase	Any part of the Water Distribution System which fails due to a defect in materials or workmanship. Associated inlet and drain plumbing parts are not covered by this warranty. During this second-year limited warranty , you will be responsible for any labor or in-home service costs.
Ten Years From the date of the original purchase	The PermaTuf[®] tub or door liner , if it fails to contain water due to a defect in materials or workmanship such as cracking, chipping, peeling or rusting. During this full ten-year warranty , GE will also provide, free of charge , all labor and in-home service to replace the defective part.

What GE Will Not Cover:

- Service trips to your home to teach you how to use the product.
- Damage to the product caused by accident, fire, floods or acts of God.
- Improper installation.
- Incidental or consequential damage to personal property caused by possible defects with this appliance.
- Replacement of house fuses or resetting of circuit breakers.
- Cleaning or servicing of the air gap device in the drain line.
- Failure of the product if it is abused, misused, or used for other than the intended purpose or used commercially.

This warranty is extended to the original purchaser and any succeeding owner for products purchased for home use within the USA. In Alaska, the warranty excludes the cost of shipping or service calls to your home.

Some states do not allow the exclusion or limitation of incidental or consequential damages. This warranty gives you specific legal rights, and you may also have other rights which vary from state to state. To know what your legal rights are, consult your local or state consumer affairs office or your state's Attorney General.

Service Telephone Numbers.



GE Answer Center® 800.626.2000

The GE Answer Center® is open 24 hours a day, 7 days a week.



In-Home Repair Service 800-GE-CARES (800-432-2737)

Expert GE repair service is only a phone call away.



Special Needs Service 800.626.2000

TDD 800-TDD-GEAC (800-833-4322)

GE offers, free of charge, a brochure to assist in planning a barrier-free kitchen for persons with limited mobility.



Service Contracts 800-626-2224

Purchase a GE service contract while your warranty is still in effect and you'll receive a substantial discount. GE Consumer Service will still be there after your warranty expires.



Parts and Accessories 800-626-2002

Individuals qualified to service their own appliances can have parts or accessories sent directly to their homes (VISA, MasterCard and Discover cards are accepted).

Instructions contained in this manual cover procedures to be performed by any user. Other servicing generally should be referred to qualified service personnel. Caution must be exercised, since improper servicing may cause unsafe operation.



Service Satisfaction

If you are not satisfied with the service you receive from GE, follow these steps. **First**, contact the people who serviced your appliance. **Next**, if you are still not pleased, write all the details—including your phone number—to: Manager, Customer Relations, GE Appliances, Appliance Park, Louisville, KY 40225.