

This Owner's Manual is provided and hosted by [Appliance Factory Parts](#).



# Haier HUF168EA Owner's Manual

[Shop genuine replacement parts for Haier HUF168EA](#)



[Find Your Haier Refrigerator Parts - Select From 1148 Models](#)

----- Manual continues below -----

# Upright Frost Free Freezer

---

## Congélateur Vertical

---

## Congelador Vertical

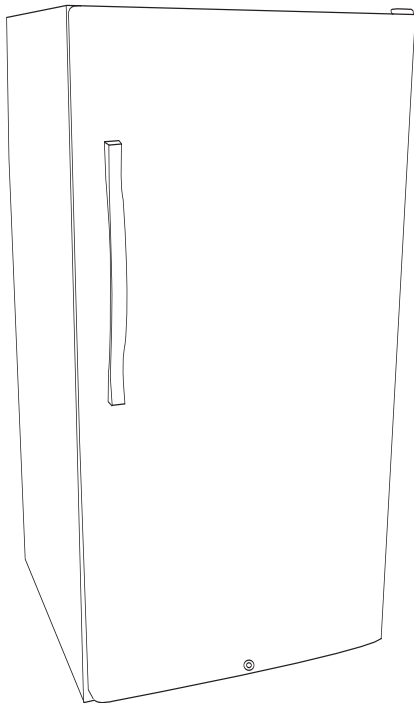

User Manual Model  
HUF138PA • HUF168PA • HUF205PA

---

Guide de l'Utilisateur  
HUF138PA • HUF168PA • HUF205PA

---

Manual del Usuario Modelo  
HUF138PA • HUF168PA • HUF205PA

**Haier**

Quality · Innovation · Style

# SAFETY PRECAUTIONS

**Read all of the instructions before using this appliance. When using this appliance, always exercise basic safety precautions, including the following:**

1. Use this appliance only for its intended purpose as described in this use and care guide.
2. This appliance must be properly installed in accordance with the installation instructions before it is used. See grounding instructions in the installation section.
3. This appliance should not be recessed or built into an enclosed cabinet. It is designed for freestanding installation only.
4. Never unplug your appliance by pulling on the power cord. Always grasp the plug firmly and pull straight out from the outlet.
5. Repair or replace immediately, all electrical service cords that have become frayed or otherwise damaged. Do not use a cord that shows cracks or abrasion damage along its length, the plug or the connector end.
6. If your old appliance is not being used, we recommend that you remove the doors and leave the shelves in place. This will reduce the possibility of danger to children.
7. When your freezer is in operation, do not touch the cold surfaces in the freezer compartment, particularly when hands are damp or wet. Skin may adhere to these extremely cold surfaces.
8. Do not refreeze foods that have been thawed completely. The United States Department of Agriculture in Home and Garden Bulletin No. 69 reads:

"...You may safely refreeze frozen foods that have thawed if they still contain ice crystals or if they are still cold - below 40°F."

"...Thawed ground meats, poultry, or fish that have any off-odor or off-color should not be refrozen and should not be eaten. Thawed ice cream should be discarded. If the odor or color of any food is poor or questionable, discard it. The food may be dangerous to eat."

"...Even partial thawing and re-freezing may reduce the eating quality of foods, particularly fruits, vegetables, and prepared foods. The eating quality of red meats is affected less than that of many other foods. Use refrozen foods as soon as possible, to save as much of their eating quality as you can."

9. Do not use any electrical device or any sharp instrument to defrost your freezer.
10. Unplug your freezer before cleaning or before making any repairs.  
**Note:** If for any reason this product requires service, we strongly recommend that a certified technician perform the service.
11. Do not operate your freezer in the presence of explosive fumes.

# SAVE THESE INSTRUCTIONS

## DANGER

**Risk of child entrapment. Before you throw away your old refrigerator or freezer, take off the doors. Leave the shelves in place so that children may not easily climb inside.**

Thank you for using our Haier product. This easy-to-use manual will guide you in getting the best use of your freezer.

Remember to record the model and serial number. They are on a label in back of the freezer.

\_\_\_\_\_  
Model number

\_\_\_\_\_  
Serial number

\_\_\_\_\_  
Date of purchase

Staple your receipt to your manual. **You will need it to obtain warranty service.**

# Table Of Contents

	<b>PAGE</b>
<b>Safety Precautions</b> .....	<b>1-2</b>
<b>Unpacking</b> .....	<b>4</b>
<b>Parts and Features</b> .....	<b>5</b>
<b>Freezer Installation</b> .....	<b>6</b>
<b>Electrical Connections</b> .....	<b>7</b>
<b>Operating Your Freezer</b> .....	<b>8-11</b>
<b>Normal Operating Sounds</b> .....	<b>11</b>
<b>Proper Care and Cleaning</b> .....	<b>12</b>
<b>Frost-Free</b> .....	<b>13</b>
<b>Extended Non-Use and Moving</b> .....	<b>13</b>
<b>Troubleshooting Guide</b> .....	<b>14</b>
<b>Warranty</b> .....	<b>15</b>

# Unpacking

## Unpacking

1. Remove all packing materials. This includes the corrugated base and all adhesive tape holding the accessories inside and outside.
2. Inspect and remove any remaining packaging, tape and printed materials before turning ON the freezer.

**Note:** Allow the freezer to stand in an upright position for at least 24 hours before turning on the power, if the freezer has been tilted for any reason.

Check to make sure that the accessories are present and in good condition. If you find that they are not in good condition or are missing, please contact our customer service department for assistance. **Our Toll-Free number is 1-877-337-3639.**

# Parts And Features

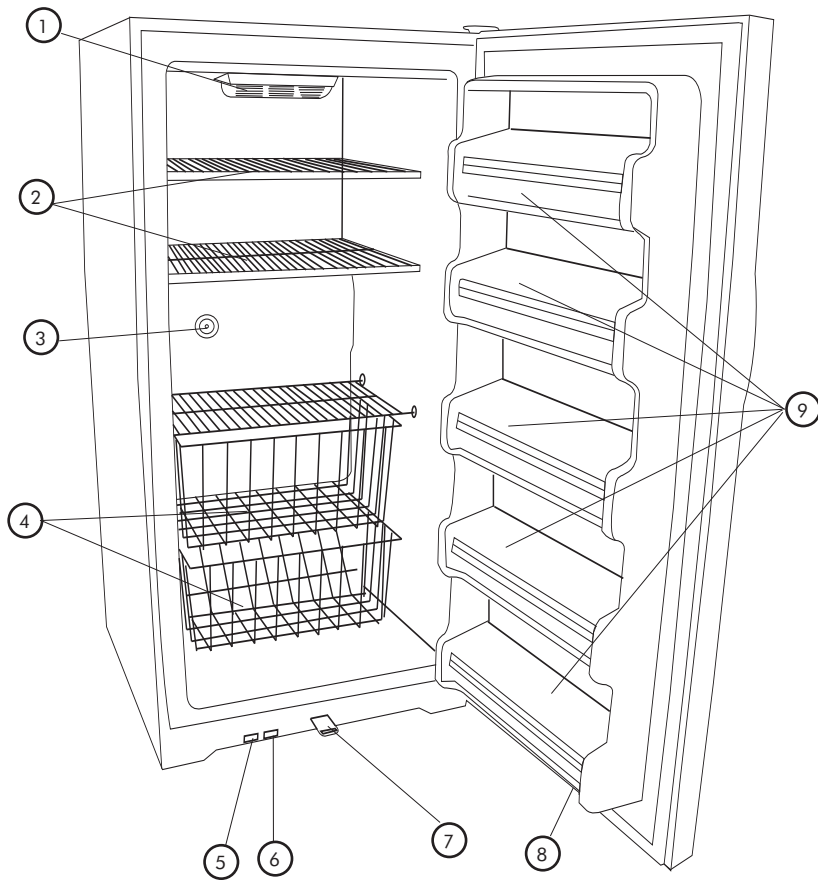

- |   |  |
|---|--|
| 1. Interior Light                                   | 6. Power Indicator Light                         |
| 2. Cabinet Wire Shelves (quantities vary per model) | 7. Locking Plate                                 |
| 3. Temperature Control Dial                         | 8. Lock (not shown)                              |
| 4. Storage Drawers (quantity varies by model)       | 9. Fixed Door Shelves (quantity varies by model) |
| 5. Temperature Alarm Switch with Indicator Light    |  |

# Freezer Installation

## Proper Location

To ensure that your upright freezer works at the maximum efficiency it was designed for, you should install it in a location where there is proper air circulation and electrical connections.

- The freezer is designed for **freestanding** installation only. It should **not be built-in**.
- Allow a minimum of 2 inch on each side and above the top of the freezer to ease installation and allow proper air circulation.
- Be sure to install your freezer on a floor that is strong enough to support the unit when fully loaded.

## Electrical Connection

### Grounding Instructions

For personal safety, this appliance must be properly grounded. In the event of an electrical short circuit, grounding reduces the risk of electric shock by providing an escape wire for the electrical current. This appliance is equipped with a cord containing a grounding wire with a grounding plug. The plug must be inserted into an outlet that is properly installed and grounded.

- Improper use of the plug may result in the risk of electric shock.
- Do not, under any circumstances, cut or remove the third (grounding) prong from the power cord.
- Consult a qualified electrician or service center if the grounding instructions are not completely understood or if in doubt as to whether the appliance has been properly grounded.

### Use of Extension Cords

- Avoid the use of an extension cord because of potential safety hazards under certain conditions. If it is necessary to use an extension cord, use only a 3-wire extension cord that has a 3-blade grounding plug and a 3-slot outlet that will accept the plug. The marked rating of the extension cord must be equal to or greater than the electrical rating of the appliance.

### Power Interruptions

- Occasionally, there may be power interruptions due to thunderstorms or other causes. Remove the power cord from the AC outlet when a power outage occurs. When power has been restored, re-plug the power cord into the AC outlet.

## Operating Your Freezer

### Temperature Control Dial (fig. 1)

- The temperature control dial has settings from "1" to "7" with "1" being the warmest and "7" being the coldest.
- Initially, set the temperature control dial at "4".
- After the freezer has been turned ON for 24 hours, adjust the temperature control dial to the setting that best suits your needs.

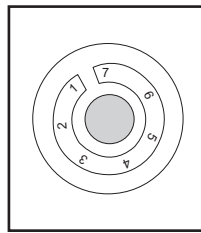

Temperature Control Dial

**Note:** If you unplug or turn OFF the freezer, wait at least 4 minutes before restarting or plugging it in again.

### Temperature Alarm System

When turning ON your freezer, the temperature alarm system switch should be at the "O" position. Put it in the "-" position once the freezer has been ON for a period of 24 hours. The temperature alarm is activated at 15.8°F. Once activated, the built-in audible alarm system will signal a warning of high temperature to you. The alarm will continue to sound until you turn OFF the temperature alarm switch. A red light will also warn you that the temperature alarm system has been activated.

### Lock and Key (fig. 2)

Your freezer has a lock and key feature to secure the contents of the freezer. Close the door, push and turn the key to lock. Push and turn the key in the opposite direction to unlock.

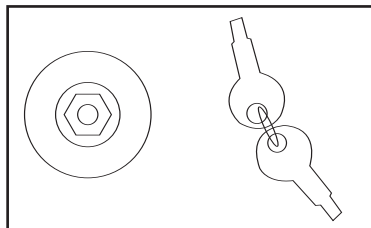

fig. 2

Lock and Key

### Replacing the Light Bulb (fig. 3)

When replacing the light bulb, follow the steps below:

1. Unplug the freezer.
2. Remove the plastic light shade located inside the freezer by lightly pressing to the left side. (see fig. 3)
3. Remove the light bulb by turning it counter-clockwise.
4. Use ONLY appliance light bulb with 25-watts of power.
5. Install a new replacement light bulb by turning it clockwise.
6. Replace the light shade to its original position.
7. Plug in the freezer, to see if you have installed the light bulb correctly.
8. If the light bulb does not turn ON, repeat the steps above.

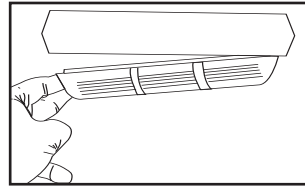

fig. 3

### Freezer Interior Shelves (fig. 4)

The shelves of the freezer were designed with you in mind. Their adjustability in position allows you to personalize the storage space to your specific needs.

To remove or adjust a full-width, slide-out shelf:

1. Gently tilt the shelf up and slide it towards you until the shelf has been completely removed. (see fig. 4)
2. To replace the shelf, select the desired setting and gently slide the shelf back until it rests in the locking position.

**Note:** All shelves are not adjustable.

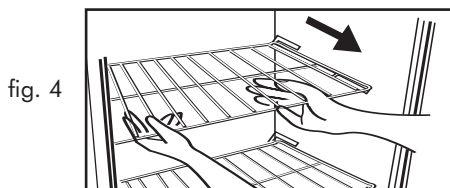
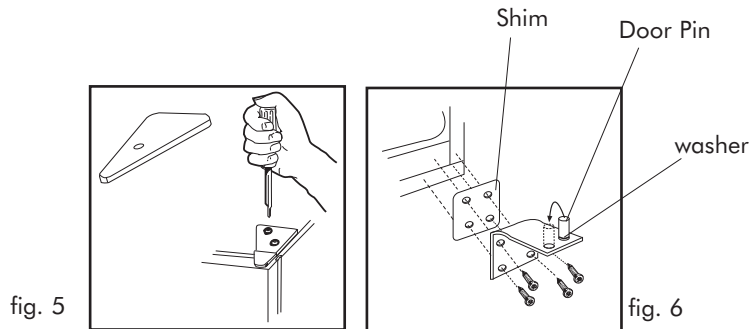

fig. 4

## Reversing the Door (fig. 5 & 6)

This freezer is equipped with a reversible door for left/right opening. If you prefer to change the direction of door opening, follow the steps below:

**Note:** The freezer comes with the door hinged to the right.



1. Fix the freezer door in place with strong adhesive tape.
2. Dismantle the hinge box cover on the top of the freezer door with a Phillips screwdriver and remove the 2 screws from the hinge. Take out the hinge by pulling up vertically. Put these aside. (see fig. 5)
3. Remove the adhesive tape on the freezer door, lift and take the door down. Carefully put it aside.
4. Remove the door pin from the bracket of the lower hinge by turning it counter clockwise. Move the pin to the opposite hole and tighten. (see fig. 6)
5. Remove the 4 screws from the lower hinge with a Hexhead screwdriver. Remove the washer and shim from the right side and install them to the left side.
6. Align the holes in the lower hinge bracket to the corresponding holes on the opposite side of the cabinet. Insert and tighten screws.
7. Align the bottom hole on the lower left side of the door with the pin of the lower hinge and slide into place.
 

**NOTE:** Remove white hole plugs from left/right top hinge holes and replace in opposite side.
8. Align the pin of the top hinge with the top hole on the left side of the door and push in place. Replace the screws in the upper hinge bracket but do not tighten all the way.
9. Align the door from top to bottom and tighten the 2 screws on the top hinge.
10. Snap on the hinge box cover.
11. Screw the hinge box cover using a phillips screw driver.

### Installing the Handle (fig. 7 & 8)

1. Use a flathead screwdriver to gently remove the plastic screw hole covers from the handle and the plastic hole plugs from the door.
2. Remove the door handle by unscrewing the upper and lower screws with a Phillips screwdriver. (see fig. 7)
3. Install the handle on the right side of the door with the screws previously removed.
4. Replace the plastic screw hole covers onto the door handle.
5. Replace the plastic door hole plugs on the side of the previously removed door handle. (see fig. 8)

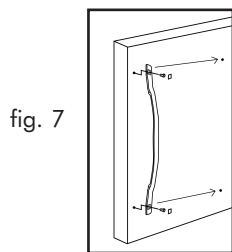

fig. 7

Door handle

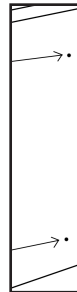

fig. 8

Door handle plugs

### Normal Operating Sounds You May Hear

- The fan circulating air inside the interior of the unit maintains the temperature you have selected.
- Boiling water, gurgling sounds or slight vibrations are the result of the refrigerant circulating through the cooling coils.
- Sizzling or popping sounds result from frost melting during the automatic defrost cycle and dripping onto the defrost heater.
- The sound of dripping water occurs as ice melts from the evaporator and flows into the drip pan during the defrost cycle.
- Cracking or popping sounds are caused by the expansion and/or contraction of the cooling coils during the defrost cycle.
- Both the defrost timer and the thermostat controls will click when they cycle ON and OFF.

# Proper Care and Cleaning

## Cleaning the Exterior

Wipe the exterior of the freezer with a damp cloth and dry thoroughly. Use only mild soapy water to clean the door gasket. Never use harsh cleansers or scouring pads to clean any part of the freezer.

For efficient operation, dirt and dust should be removed from the rear and bottom of your freezer every 3 months.

- Turn the temperature control dial to "1" and unplug the freezer before cleaning.
- Carefully slide the freezer away from the wall slowly to avoid damaging the floor.
- Wipe dust from the back of the freezer and the outside of the compressor compartment with a clean dry cloth or use a vacuum cleaner with a brush attachment.

**Note:** Do not attempt to clean inside the compressor compartment.

## Cleaning the Interior

Clean the inside of the freezer at least twice a year. Turn the temperature control dial to "1", unplug the freezer and remove all frozen items from the shelves. Wash the inside with a solution of warm water and baking soda (2 tablespoons of baking soda to one quart of water), then rinse and dry thoroughly. Do not use cleaners such as harsh detergents, scouring powder or sprays containing bleach, ammonia, or other chemicals that may cause odors inside the freezer or damage the protective coating on the shelves.

## Frost Free

Your freezer is frost-free. No defrosting is required as it is factory preset to automatically defrost.

## Extended Non-Use and Moving

### Extended Non-Use

For long vacations or absences, empty food from the freezer, move the temperature control dial to the OFF position and disconnect the power cord from the wall outlet. Clean the freezer and door gaskets according to the Proper Care and Cleaning section. Prevent odors from forming by placing an open box of baking soda in the freezer and propping the door open to allow air to circulate inside.

### Moving the Freezer

When transporting the freezer, it should be kept in an upright position. If the freezer is inadvertently tilted beyond 45 degrees or was laid down horizontally for any reason (e.g., shipping), the unit must not be operated for at least 24 hours. It must be placed in the upright position for 24 hours to allow the internal oil and refrigerant to stabilize in the system. Ignoring this precautionary measure may result in damage to the sealed system and compressor.

# Troubleshooting Guide

**Freezer does not operate.**

- The unit may not be plugged in.
- The circuit breaker may have tripped or the fuse may have been blown.

**Compressor seems to run continuously or more often than necessary.**

- The door may have been left open or there may be a leak in the door gasket.
- Frequent door openings allow cold air to escape, thus forcing the compressor to cycle ON more often.
- Air is not circulating freely around the appliance due to installation in an area with little or no clearance. Slide the appliance out of the confined area and vacuum around the rear and bottom to improve air circulation.

**Freezer compartment has an odor.**

- Foods with strong odors should be tightly covered.
- Check for spoiled food.
- Interior may require cleaning.
- Keep an open box of baking soda in the freezer to absorb odors and replace as needed.

**Foods are not sufficiently frozen.**

- The temperature setting is not high enough.
- The door has been left open for an extended period of time or there may be a leak in the door gasket.
- Overloaded shelves are preventing effective circulation of cold air.

# Limited Warranty

## What is covered and for how long?

This warranty covers all defects in workmanship or materials for a period of:

**12 months labor**

**12 months parts**

**5 years sealed system**

The warranty commences on the date the item was purchased and the original purchase receipt must be presented to the authorized service center before warranty repairs are rendered.

### **EXCEPTIONS: Commercial or Rental Use warranty**

**90 days labor (carry-in only)**

**90 days parts**

**No other warranty applies**

## What is covered.

1. The mechanical and electrical parts, which serve as a functional, purpose of this appliance for a period of 12 months. This includes all parts except finish, and trim.
2. The components of the sealed system e.g. hermetic compressor, condenser and evaporator from manufacturing defects for a period of 5 years from the date of purchase. Any damages to such components caused by mechanical abuse or improper handling or shipping will not be covered.

## What will be done?

1. We will repair or replace, at our discretion any mechanical or electrical part which proves to be defective in normal usage during the warranty period so specified.
2. There will be no charge to the purchaser for parts and labor on any covered items during the initial 12 month period. Beyond this period only parts are covered in the remaining warranty. Labor is not

provided and must be paid by the customer.

3. Contact your nearest authorized service center. For the name of the nearest service center please call 1-877-337-3639

### **THIS WARRANTY COVERS APPLIANCES WITHIN THE CONTINENTAL UNITED STATES, PUERTO RICO AND CANADA. IT DOES NOT COVER THE FOLLOWING**

Damages from improper installation.

Damages in shipping.

Defects other than manufacturing.

Damage from misuse, abuse, accident, alteration, lack of proper care and maintenance or incorrect current or voltage.

Damage from other than household use.

Damage from service by other than an authorized dealer or service center.

Decorative trims or replaceable lightbulbs.

Transportation and shipping.

Labor (after the initial 12 months).

**THIS LIMITED WARRANTY IS GIVEN IN LIEU OF ALL OTHER WARRANTIES, EXPRESSED OR, INCLUDING THE WARRANTIES OF MERCHANTABILITY AND FITNESS FOR A PARTICULAR PURPOSE**

The remedy provided in this warranty is exclusive and is granted in lieu of all other remedies.

This warranty does not cover incidental or consequential damages, so the above limitations may not apply to you. Some States do not allow limitations on how long an implied warranty lasts, so the above limitations may not apply to you.

This warranty gives you specific legal rights, and you may have other rights, which vary, from state to state.

Haier America  
New York, NY 10018

# IMPORTANT

## Do Not Return This Product To The Store

If you have a problem with this product, please contact the  
"Haier Customer Satisfaction Center" at 1-877-337-3639.  
DATED PROOF OF PURCHASE, MODEL # AND SERIAL #  
REQUIRED FOR WARRANTY SERVICE

# IMPORTANT

## NE PAS RETOURNER CET ARTICLE AU MAGASIN

En cas de problème avec cet article, veuillez contacter le « Centre satisfaction client » de  
Haier au 1-877-337-3639.  
UNE PREUVE D'ACHAT DATÉE, LE NUMÉRO DU MODÈLE ET LE NUMÉRO DE SÉRIE SONT  
OBLIGATOIRES POUR BÉNÉFICIER DE LA COUVERTURE OFFERTE PAR LA GARANTIE.

# IMPORTANTE

## No Devuelva Este Producto al Establecimiento Compra.

Si tiene problemas con este producto, por favor póngase en contacto con el "Centro Haier  
de Atención al Cliente" en el 1-877-337-3639.  
PARA EL SERVICIO DE GARANTÍA SE REQUIERE PRUEBA DE COMPRA, FECHADA, No. DE  
MODELO Y No. DE SERIE

115V, 60 Hz

Made in USA  
Fabriqué en USA  
Hecho en USA



Haier America  
New York, NY 10018

Printed in USA  
Imprimé en USA  
Impreso en USA