

# Oreck U2640RH Owner's Manual

[Shop genuine replacement parts for Oreck U2640RH](#)

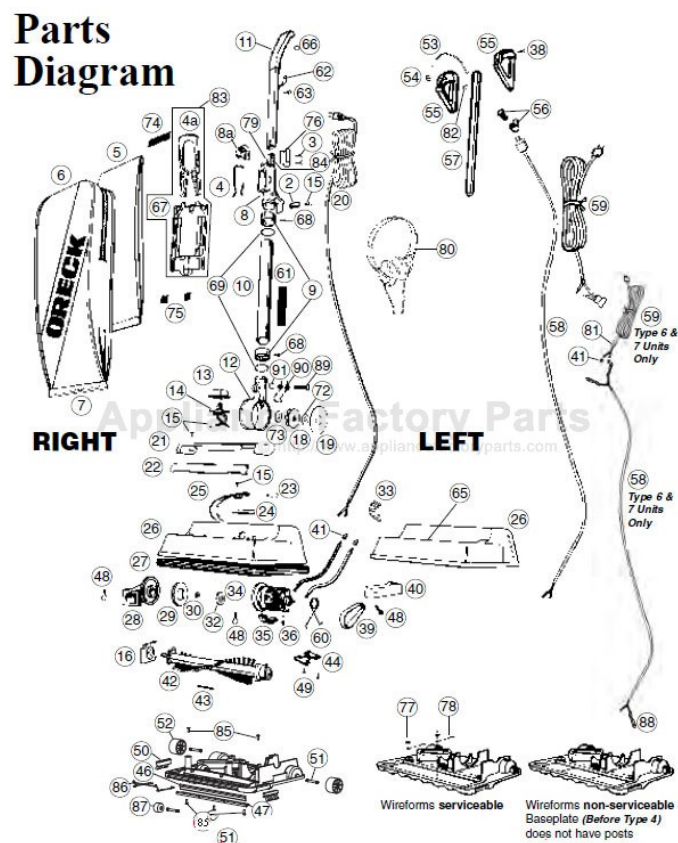

[Find Your Oreck Vacuum Cleaner Parts - Select From 249 Models](#)

----- Manual continues below part list -----

## Available Replacement Parts for Oreck U2640RH

<a href="#">OR-1000</a>	BELT, FLAT, UPRIGHTS, 1PK
<a href="#">V099</a>	ORECK BAGS 8 PACK
<a href="#">OR-6000</a>	MOTOR AFTERMARKET
<a href="#">OR-7200</a>	FAN HOUSING ASSY
<a href="#">OR-2000</a>	BRUSHROLL ASSEMBLY O-016-1152

# Parts Diagram

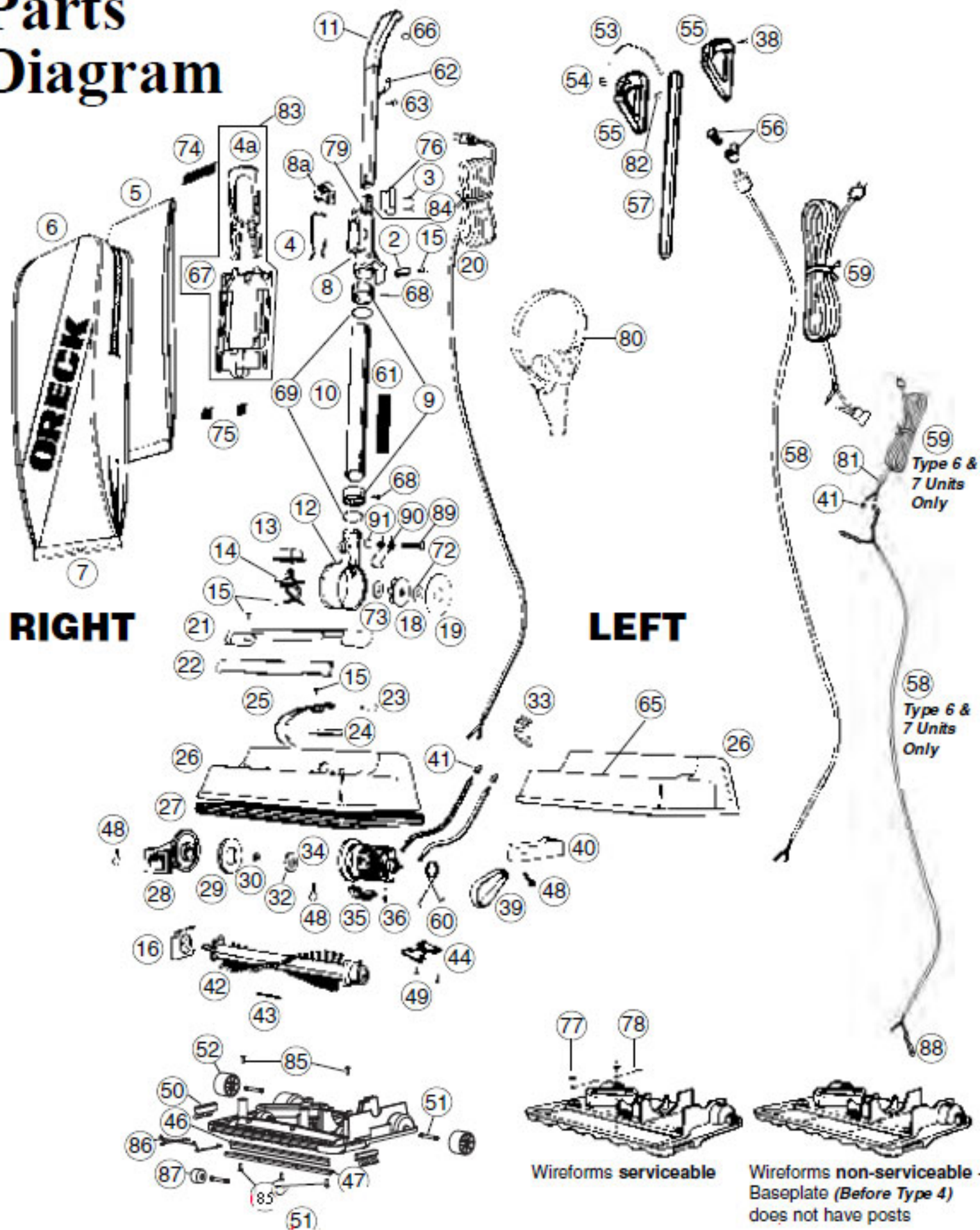

# Parts Assemblies

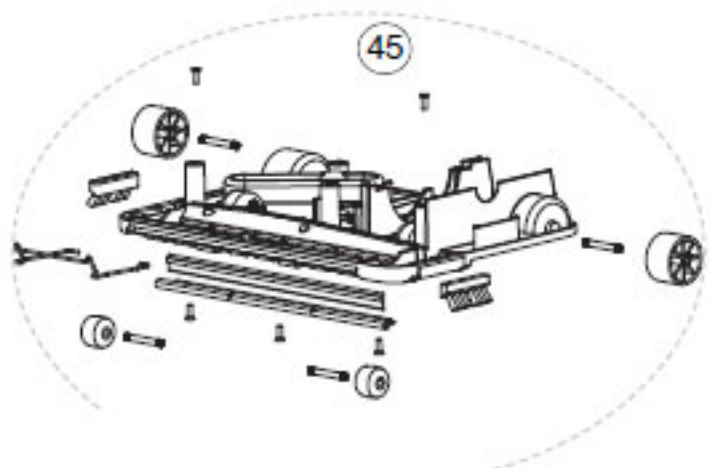
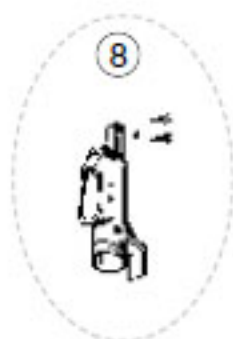
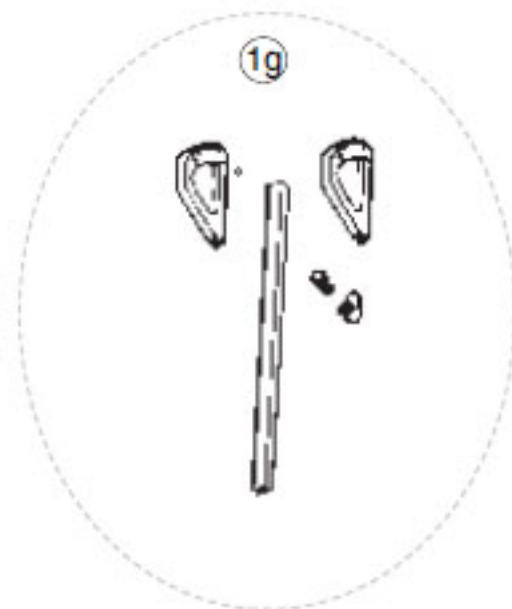
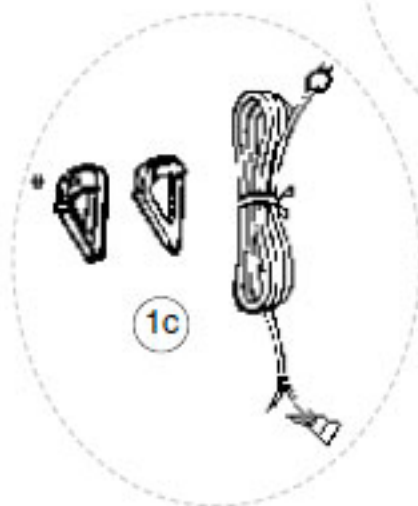
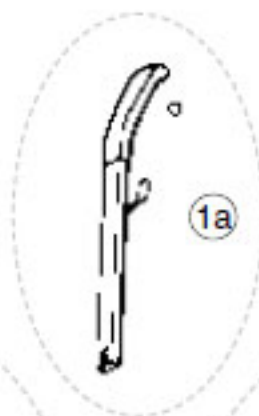

**Part Numbers Listing: XL2540RH / XL2320RH / U2640RH / U2510RH / U2520RH / U2530RH**  
**Regular Bag, No Lights, Helping Hand Handle**

#	Item	Order #	Qty.	Pk.			
1b	XL2540RH: Handle Assembly includes items #38, #53, #54, #55, #56, #57, #59	09-75288-07	1	1			
	XL2320RH: Handle Assembly includes items #38, #53, #54, #55, #56, #57, #59	09-75288-18	1	1			
1c	XL2540RH: Tortuous Grip & Cord Assembly, includes items #54, #55, #59	09-75342-07	1	1	NLA	NLA	NLA
1e	Kit, Retro, Handle Assembly, Residential, White, includes items #38, #54, #55, #58, #59, #61, #62 Type 1, 2, 3, 4 & 5 Units Only	09-75612-01	1	1			
4a	Docking Clip, Rear, Blue, Type CC (use w/#67 or order #63)	75583-01-438	1	1			
5	Dust Bag, (8 Pk.) Regular	CCPK8	1	8			
	Dust Bag, (25 Pk.) Regular	CCPK25	1	25			
6	XL2320RH: Outer Bag, Dark Gray, Red, USA	75246-27	1	1			
	XL2540RH / U2640RH: Outer Bag, Dk Gray, Black, Dark Gray	75246-11	1	1			
	U2510RH: Outer Bag, Dark Gray, Red, Red	75246-38	1	1			
	U2520RH: Outer Bag, Dark Gray, Black, White	75246-39	1	1			
	U2530RH: Outer Bag, Dark Gray, Blue, Blue	75246-37	1	1			
7	XL2540RH: Bag Clip, Dark Green	09-75078-11	1	1			
	XL2320RH: Bag Clip, Navy / Silver	09-75078-15	1	1			
	U2640RH: Bag Clip, Black / Silver	09-75078-06	1	1			
	U2510RH: Bag Clip, Red / Silver	09-75078-08	1	1			
	U2520RH: Bag Clip, White / Silver	09-75078-22	1	1			
	U2530RH: Bag Clip, Blue / Silver	09-75078-24	1	1			
8	Connector Assembly Kit, includes items #3 & #64	09-75308-57	1	1			
8a	Deflector, Black, Snap Type 1 & 2 Units Only	75220-01-0327	1	1			
9	Collar	75309-02-0327	2	1			
10	Tube Assembly Type 1, 2, 3 & 4 Units Only	75188-01	1	1			
	Tube Assembly Type 5, 6 & 7 Units Only	75198-05	1	1			
12	Fan Housing Assembly includes Rivet & Spring	09-75343-03	1	1			
16	End Cap	0134623	1	1			
18	METAXALLOY™ Fan Kit w/Washers	09-75300-01	1	1			
19	Fan Seal Cup	75012-01	1	1			
20	Cord Set	see #59					
26	XL2320RH: Housing, Navy w/Label	09-75426-14	1	1			
	XL2540RH / U2640RH: Housing, Gulf Gray w/Label	09-75426-21	1	1			
	U2510RH: Housing, Red w/Label	09-75426-23	1	1			
	U2520RH: Housing, White w/Label	09-75426-24	1	1			
	U2530RH: Housing, Blue w/Label	09-75426-25	1	1			
27	XL2540RH / XL2320RH / U2640RH / U2510RH / U2520RH / U2530RH: Bumper, White	75181-03	1	1			
28	Intake Pivot Assembly with Felt Seal	09-75066-02	1	1			
29	Felt Seal	75065-01	1	1			
32	Felt Seal, Motor	75117-01M	1	100			
33	Cord Retainer, Round Type 1, 2 & 3 Units Only	03-00455-01	1	1			
	Cord Retainer, Square Type 4, 5, 6 & 7 Units Only	03-00494-01	1	1			
34	Motor Assembly Kit	09-75505-01	1	1			
35	Motor Seal	75095-01	2	1			
36	Kit, Motor Brush (Large & Small) / Spring	09-75514-01	2	2			
39	Drive Belt, (3 Pk.)	0300604	1	3			
39a	Drive Belt, Single	75024-01	1	1			
40	XL2540RH: Door Belt, Dark Green	75057-01-439	1	1			
	XL2320RH: Door Belt, Navy	75057-01-0432	1	1			
	U2640RH: Door Belt, Gulf Gray	75057-02-0384	1	1			
	U2510RH: Door Belt, Red	75057-01-441	1	1			
	U2520RH: Door Belt, Wht.:	75057-01-0432	1	1			

**Part Numbers Listing: XL2540RH / XL2320RH / U2640RH / U2510RH / U2520RH / U2530RH cont.**

Regular Bag, No Lights, Helping Hand Handle

#	Item	Order #	Qty.	Pk.			
	U2530RH: Door Belt, Blue	75057-01-442	1	1			
42	Brush Roll, Plastic Pulley	75202-01	1	1			
43	Seal, Baseplate	75008-01	1	1			
44	Plastic Detent, (uses 2 #49 screws)	75299-01	1	1			
45	Complete Baseplate Assembly includes: #43, #46, #47, #50, #51, #52, #65, #66, #67	09-75715-01	1	1			
46	MICRO SWEEP Blade Type 1-6 Units Only	75009-01	1	1			
	MICRO SWEEP Blade Type 7 Units Only	75700-01	1	1			
47	Channel Type 1-6 Units Only	75007-02	1	1			
	Channel Type 7 Units Only	75701-01	1	1			
50	Edge Brush w/Wheel, Left Type 1-6 Units Only	09-75249-02	1	1			
	Edge Brush w/Wheel, Right Type 1-6 Units Only	09-75250-02	1	1			
	Edge Brush w/o Wheels, Left & Right	75179-03	2	1			
51	Wheel Axle	03-00630-01M	2/4"	100			
52	Soft Rear Wheel, Black	75187-01-0327	2	1			
53	Static Wire Type 1, 2, 3, 4 & 5 Units Only	75037-01	1	1			
54	XL2540RH / XL2320RH: Switch, 2 Position Assembly	75110-02	1	1			
	U2640RH / U2510RH / U2520RH / U2530RH: Switch, 2 Position Assembly	75559-01	1	1			
55	XL2540RH: Grips, Dark Green Set Type 2, 3, 4 & 5 Units Only (Type 1 Units Order Assembly 1e For Grips)	09-75301-07	1	1			
	XL2320RH: Grips, Navy Set	09-75301-21	1	1			
	U2640RH: Grips, Gull Gray Set	09-75576-29	1	1			
	U2510RH: Grips, Red Set	09-75576-28	1	1			
	U2520RH: Grips, White Set	09-75576-19	1	1			
	U2530RH: Grips, Blue Set	09-75576-30	1	1			
56	XL2540RH: Cord Wrap Assy, includes Post & Cord Wrap, Gray	09-75185-09	1	1			
	XL2320RH / U2640RH / U2530RH: Cord Wrap Assy, includes Post & Cord Wrap, Black	09-75185-01	1	1			
	U2510RH: Cord Wrap Assy includes Post & Cord Wrap, Red	09-75185-07	1	1			
	U2520RH: Cord Wrap Assy includes Post & Cord Wrap, White	09-75185-05	1	1			
57	XL2540RH / XL2320RH / U2640RH / U2510RH / U2520RH / U2530RH: Handle Tube, Chrome	75190-03	1	1			
58	XL2540RH / XL2320RH: Cord, Harness Assembly	75081-01	1	1			
	U2640RH: Cord, Harness Assembly	75552-02-327	1	1			
	U2510RH / U2520RH / U2530RH: Cord, Harness Assembly	75552-02-326	1	1			
59	XL2540RH / XL2320RH: Cord Set, White Type 2, 3, 4 & 5 Units Only (Type 1 Units Order Assembly 1e For Cord Set)	75292-01-326	1	1			
	U2640RH: Cord Set, Black	75556-02-327	1	1			
	U2510RH / U2520RH / U2530RH: Cord Set, White, 30'	75556-02-326	1	1			
60	Motor Spring	75283-01	2	1			
61	Tube Label	75087-05	1	1			
65	"Oreck" Name Plate Label	75599-03	1	1			
67	Bag Dock Hinge, Blue, Type CC (use w/#4a or order #63)	75582-01-438	1	1			
	User's Manual	75416-05	1	1			
	Vacuum Cleaner Cover	VACCOVER	1	1	NLA	NLA	NLA
	Magnet Clean Vacuum Protector	MC4BK	1	1			
79	Stiffener (uses same length screws, notched)	75189-02	1	1			
	Stiffener, Through Bolt Connector (uses different length screws)	75619-01	1	1			
81	Cord Flex Relief Type 6 & 7 Units Only	03-00600-01	1	1			
83	Kit, Bag Dock, includes items #4a & #67	09-75657-01	1	1			
87	Front Wheel Type 7 Units Only	75709-01	2	1			

\*Type 7 Units

# STANDARD FASTENER HARDWARE LISTING

Fasteners Fit Uprights Listed in Service Manual

#	FASTENER DESCRIPTION	FASTENER PART NO.	PART THAT FASTENER IS USED ON	QTY REQ'D	TORQUE RANGE (in/lb)	QTY PER PKG.
2	Cord Clamp	03-00613-01M	Foot Switch Units	1	n/a	100
		03-00619-01M	D-Handle Units	1	n/a	100
3	Screw, #8 - 32 x .440 Nylock Screw, #8 x .811 w/ Int Washer	03-00478-02M	Handle Tube	2	18 - 22	100
		03-00608-01M	Handle Tube w/Through Bolt	1	18 - 22	100
	Screw, #8-32 X .545 w/ Washer Screw, #8 - 32 x 29/32 w/ Washer	03-00504-02M	Handle Brace	2	18 - 22	100
		03-00605-01M	Handle Brace w/Through Bolt	1	18 - 22	100
15	Screw, #8 X .5 Phillips	03752-01M	Headlight Cover, Bulb Holder, Foot Switch, Cable Clamp	2/2 2/1	13 - 16	100
30	1/4 X 32 Yellow Chrome	03-00448-01M	Fan	1	18 - 20	100
38	Screw, #8 X .75 Phillips Screw, #8 x .75	03-00456-01M	D-Handle (small head)	4	17 - 20	100
		03-00476-01M	D-Handle <i>Type 6 &amp; 7 Only</i>	6	17 - 20	100
41	Wire Nut	03-00599-01M		as req'd	35 - 55	100
48	Screw, #8 x .75 Phillips	03-00476-01M	Baseplate, Belt Door,	5 / 1	13 - 16	100
			Intake Pivot,	1	13 - 16	100
			Motor	2	17 - 20	100
49	Screw, #7 X .38 Phillips	03-00475-01M	Edge Brush <i>Type 1-6 Only, Detent</i>	2 / 2	5 - 8	100
63	Screw, #10 x .5 Phillips	03-00450-01M	Cord Bracket	1	13 - 16	100
68	Screw, #6-20 x 1/4"	03-00482-01M	Collar <i>Type 1 &amp; 2 Only</i>	2	4 - 5	100
69	O-Ring	75191-02M	Collar	2	n/a	100
72	Washer, Thrust	03-00479-01M	Fan	1	n/a	100
73	Washer, Lock External Tooth	03-00480-01M	Fan	1	n/a	100
74	1" x 3", Loop Fastener	75304-01M	Bag Support	1	n/a	100
75	1" x 1", Hook Fastener	75303-01M	Bag Dock	2	n/a	100
77	Retainer Clip	03528M	Baseplate <i>Type 1-6 Serviceable</i>	2	n/a	100
78	Wireform	75194-03M	Baseplate <i>Type 1-6 Serviceable</i>	2	n/a	100
82	Steel Bushing Ring	03-00598-01M	D-Handle	1	n/a	100
84	Nut, Square	03-00606-01M	Connector	1	n/a	100
85	Screw, #6-20 x 7/16 Flat Undercut	03-00626-01M	Edge Brush, Channel <i>Type 7 Only</i>	2 / 3	6 - 8	100
86	Wireform, One-Piece	75698-01	Baseplate <i>Type 7 Only</i>	1	n/a	1
88	JST Insulator	75679-01M	Harness	1	n/a	100
89	Rivet	03-00453-01M	Fan Housing	1	n/a	100
90	Bag Spring	75015-01M	Fan Housing	1	n/a	100
91	Push Nut	03-00636-01M	Fan Housing	1	n/a	100

## Product Information

- Minimum water lift: 9 in. @ nozzle sealed suction
- Power consumption 120V/60Hz: 4.0 amps, 480 watts
- Weight: 8 lbs. without power cord
- Switch rating: 8 amps, 120 volts
- Power cord rating - Domestic 18/2 SJT 105°C  
Commercial: 18/3 SJT 105°C

## Data Label



**Type Code:** Represents product service revision number.

**Type 1:** Initial Production

**Type 2:** Improved strain relief  
D-Grip Handle.

**Type 3:** Improved deflector and  
removed collar set screw.

**Type 4:** Square cord retainer.

**Type 5:** Improved lower tube.

**Type 6:** Hardwire handle.

**Type 7:** Improved baseplate with one-  
piece wireform.

**Julian Date Code:**

Represents date of manufacture.

98 Represents the year.

166 Represents the day in that year

## Service Information

- Component configuration on exploded view may differ in case of specific versions. However, the actual components are distinguished by means of item and part numbers.
- If a repair has been made, make sure that all functions of the appliance are working correctly.
- Spare parts have been standardized as much as possible and the part may not be the exact replacement part.
- Only the new **METAXALLOY™** motor fan available.
- Only the new soft single rear wheel style available.
- Only housings with belt access door available.
- When assembling fan seal to fan housing, use a small bead of silicone.
- Only new plastic detent available.
- Baseplate assemblies with one-piece wireform are interchangeable on Type 1-6 units.