

This Owner's Manual is provided and hosted by Appliance Factory Parts.

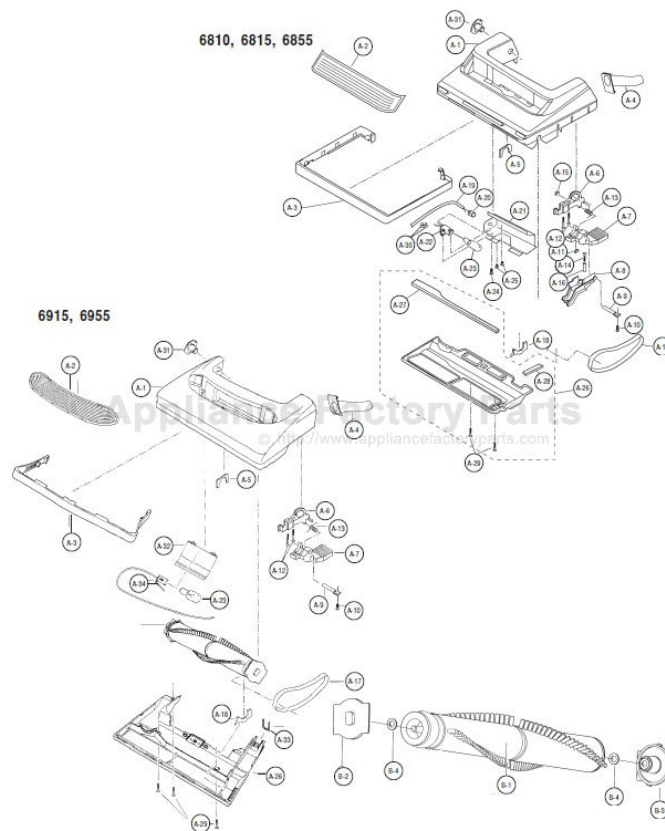

PANASONIC MC-6915 Owner's Manual

[Shop genuine replacement parts for PANASONIC
MC-6915](#)



[Find Your PANASONIC Vacuum Cleaner Parts - Select From 605 Models](#)

----- Manual continues below -----

PANASONIC

Original & Replacement

Model 6810, 6815, 6855, 6915, 6955

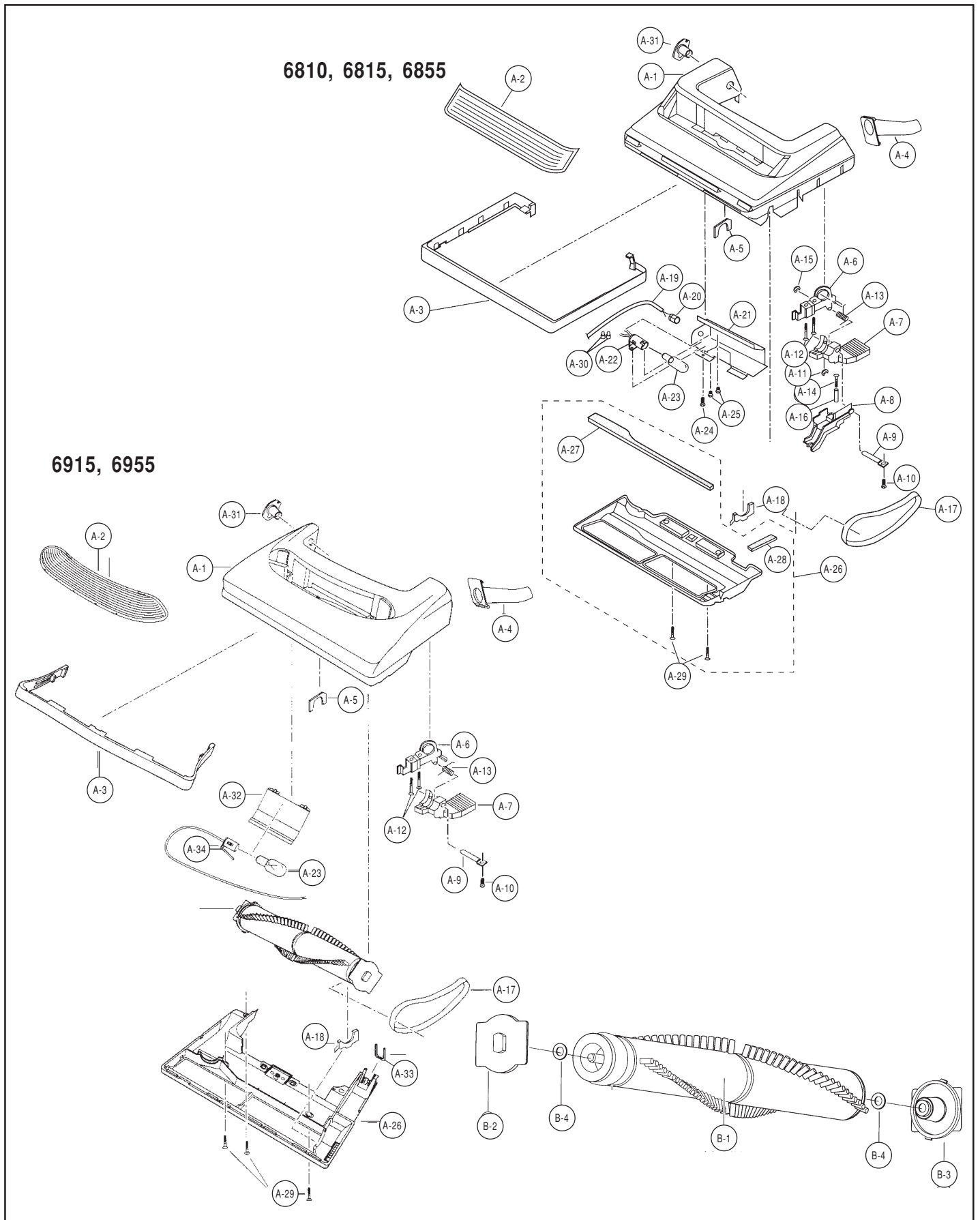

Original & Replacement **PANASONIC**

Models 6810, 6815, 6855, 6915, 6955

PARTS LIST (NOZZLE HOUSING)

KEY	PART NO.	DESCRIPTION	KEY	PART NO.	DESCRIPTION
A-1	NLA	Nozzle Housing, 6810	A-16	P-72070	Spacer, 6810/6815/6855
A-1	P-73097	Nozzle Housing, 6815	A-17	P-MC210B	Belt, UB 2 Pk
A-1	NLA	Nozzle Housing, 6915	A-17	PR-1015	Belt, UB
A-1	P-73098	Nozzle Housing, 6855	A-18	P-76435	Agitator Holder, 6810/6815/6855
A-1	NLA	Nozzle Housing, 6955	A-18	P-76740	Lower Plate Packing, 6915/6955
A-2	P-75814	Window, 6810/6815/6855	A-19	P-37G-V30	Wire Cord, 6810/6815/6855
A-2	P-75812	Window, 6915/6955	A-20	P-58E-V30	Wire Bushing, 6810/6815/6855
A-3	P-74048	Furniture, Guard 6810/6815/6855	A-21	P-85H-2X0	Bulb Supporter, 6810/6815/6855
A-3	P-74027	Furniture, Guard 6915/6955	A-22	P-93HZK000	Lamp Holder, 6810/6815/6855
A-4	P-73436	Nozzle Pipe	A-23	FA-3500	Bulb, 25 Watt
A-5	P-76425	Tight Packing	A-24	P-77020	Screw (Bulb Supporter), 6810-6855
A-6	P-73421	Frame	A-25	P-XTN3+9BFY	Screw (Lamp Holder), 6810-6855
A-7	P-73728	Pedal (Black)	A-26	P-76057	Lower Plate Ass'y, 6810/6815/6855
A-8	P-73425	Belt Cover, 6810/6815/6855	A-26	NLA	Lower Plate, 6915/6955
A-9	P-51A-2V0	Pedal Shaft	A-27	P-76107	Packing (Lower Plate Back), 6810-6855
A-10	P-77020	Screw (Pedal Shaft)	A-28	P-39A-2V0	Packing (Lower Plate Right), 6810-6855
A-11	NLA	E-Clip, 6810/6815/6855	A-29	P-77012	Screw (Lower Plate)
A-12	P-77020	Screw (Frame)	A-30	SS-3270	Wire Nut, 6810-6855
A-13	P-77206	Pedal Spring	A-31	P-73900	Plastic Shaft
A-14	P-77033	Screw (Spacer), 6810/6815/6855	A-32	P-84HURZW000	Reflector, 6915/6955
A-15	NLA	E-Clip, 6810/6815/6855	A-33	P-76315	Belt Cover, 6915/6955
			A-34	P-93HUKZ0000	Bulb Socket, 6915/6955

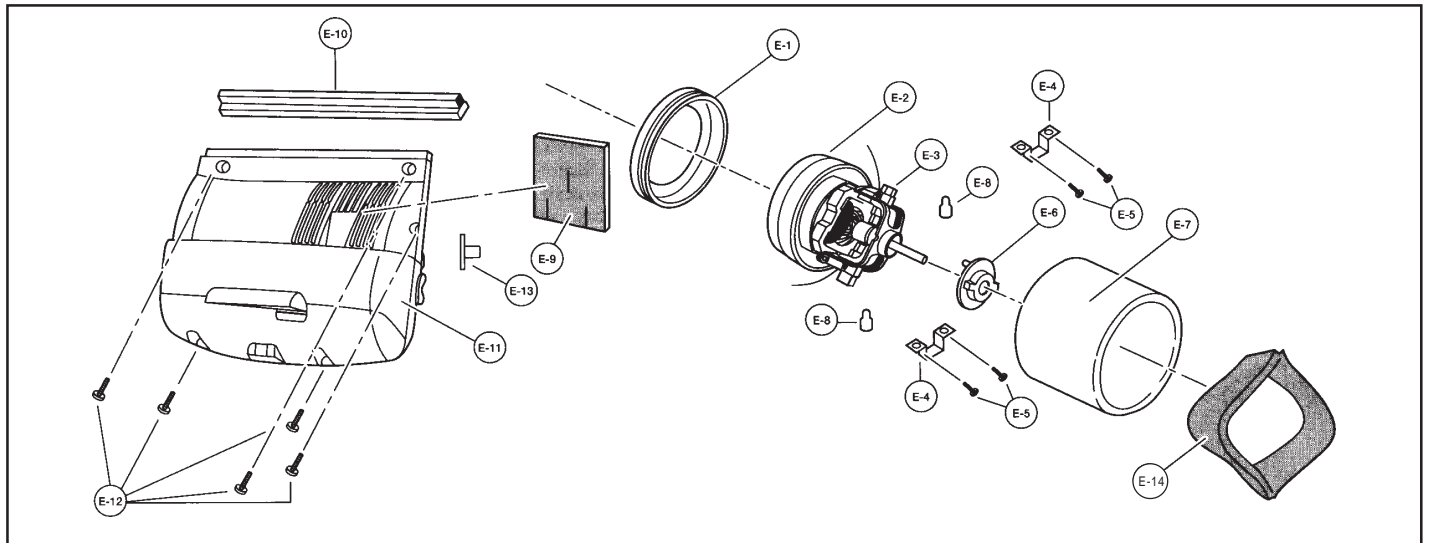

PARTS LIST (BRUSHROLL)

B-1	P-20020	Agitator Unit	E-5	P-40D-V300U	Screw (Brush Retainer Bracket)
B-2	P-20525	End Cap "A"	E-6	P-76769	Motor Support (Rubber Rear)
B-3	P-20535	End Cap "B"	E-7	P-18706	Noise Suppressor
B-4	P-681-424	Washer	E-8	P-1CTCE23	Wire Nuts

PARTS LIST (MOTOR HOUSING)

E-1	P-76768	Motor Support (Rubber Front)	E-9	P-75085	Rear Cover Packing
E-2	P-60125	Fan Motor Unit, 6815/6855	E-10	P-19FV0ZKU12	Packing (Motor Case)
E-2	P-60135	Fan Motor Unit, 6810, 6915, 6955	E-11	P-75080	Motor Case, 6810
			E-11	P-75120	Motor Case, 6915
			E-11	P-75125	Motor Case, 6815, 6855, 6955
E-3	P-63052	Carbon Brush Ass'y	E-12	P-77020	Motor Case Screws
E-4	P-02D-V300U	Carbon Brush Retainer Bracket	E-13	P-75930	Plastic Holder
			E-14	P-41FURZ000	Cooling Guide, 6855/6915/6955

NLA = No Longer Available

PANASONIC Original & Replacement

Model 6810, 6815, 6855, 6915, 6955

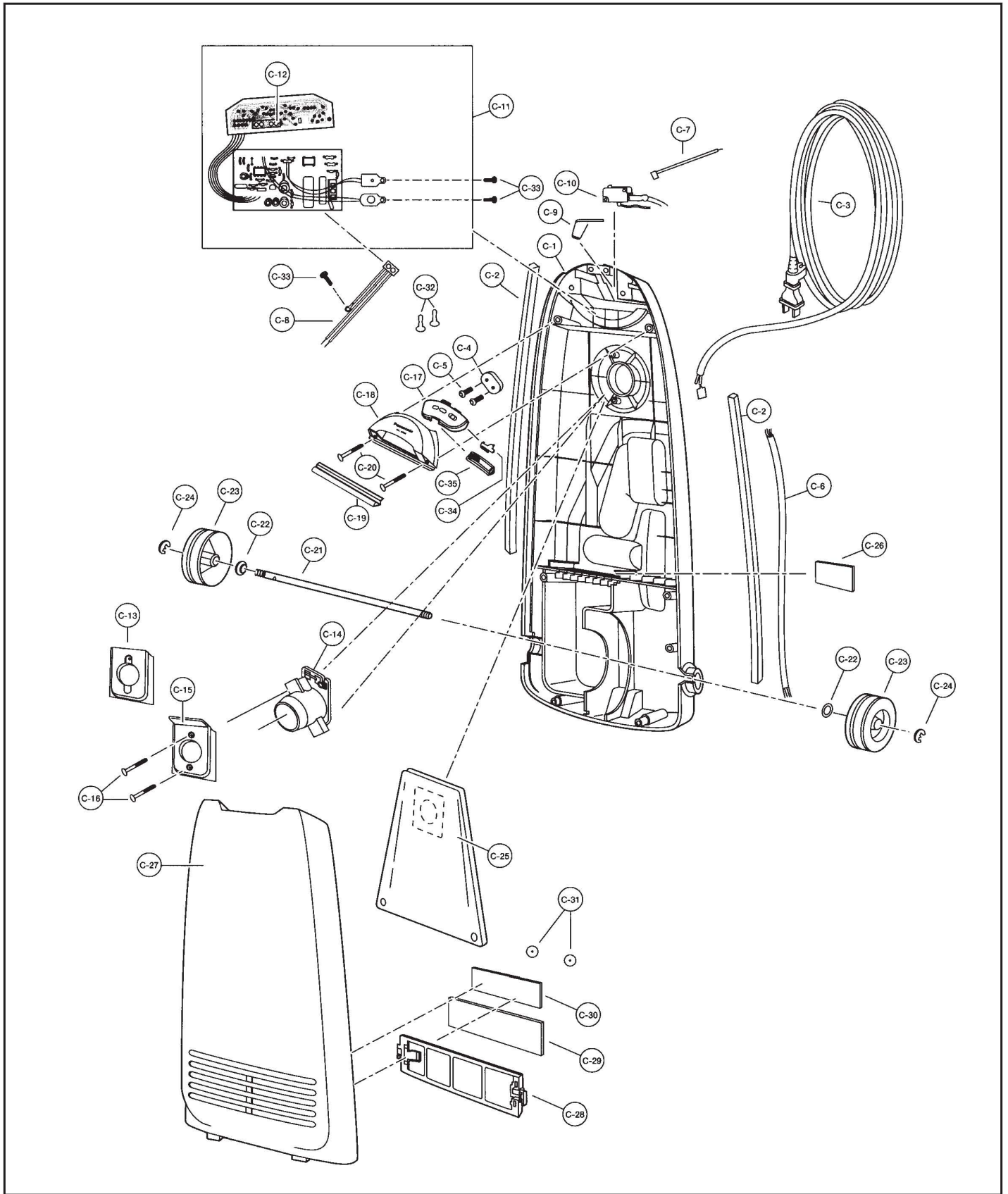

Original & Replacement **PANASONIC**

Model 6810, 6815, 6855, 6915, 6955

PARTS LIST (DUST COMPARTMENT)

KEY	PART NO.	DESCRIPTION
C-1	P-75275	Dust Compartment, 6815
C-1	NLA	Dust Compartment, 6810/6855/6915/6955
C-2	P-66K-V30J	Dust Compartment Packing
C-3	P-97EYXZV000	Power Cord, 6810
C-3	P-30044	Power Cord, 6815/6915
C-3	P-30045	Power Cord, 6855
C-3	P-30047	Power Cord, 6955
C-4	P-62E-J20	Cord Stopper
C-5	P-77020	Screw (Cord Stopper)
C-6	P-37G-V200U	Wire Cord
C-7	P-36024	Lead Wire
C-8	P-67VZAZ0000	Lead Wire AU, 6855/6955
C-9	P-34921	Switch Lever
C-10	P-34127	Switch On/Off
C-11	P-87GZAZ0000	PC Ass'y, 6855/6955 (Includes C-12)
C-12	P-59VZAZ0000	PCB Holder, 6855/6955
C-13	P-10KYYZV007	Bag Supporter, 6810/6815/6915
C-14	P-10KZAZK012	Bag Supporter, 6855/6955
C-15	P-28MZAZV007	Fin Cover, 6855/6955
C-16	P-77020	Screw
C-17	P-21TYZZU001	Ornamental Plate, 6855/6955
C-18	NLA	Switch Cover, 6810
C-18	NLA	Switch Cover, 6815
C-18	NLA	Switch Cover, 6855

KEY	PART NO.	DESCRIPTION
C-18	P-03EUSZGU06	Switch Cover, 6915
C-18	NLA	Switch Cover, 6955
C-19	P-73KZAZK012	Packing (Switch Cover)
C-20	P-77020	Screw (Switch Cover)
C-21	P-71350	Roller Shaft
C-22	P-XWG6E115FY	Washer (Roller Shaft)
C-23	P-71125	Wheel (Black)
C-24	P-XUC5FY	E-Clip
C-25	P-MC115P	Dust Bag, U3 3 Pack
C-26	P-18067	Secondary Filter
C-27	P-60KYYZB013	Dust Cover, 6810
C-27	P-60KYYZR009	Dust Cover, 6815/6855
C-27	P-60KYYZG006	Dust Cover, 6915
C-27	P-60KYYZR003	Dust Cover, 6955
C-28	P-18460	Filter Supporter, 6855-6955
C-29	P-MC180E	Electrostatic Filter, 6855-6955
C-30	P-18038	Filter, 6810/6815
C-31	P-415-5375	1/8 Spring Push Nut, 6810/6815
C-32	SS-3270	Wire Nut
C-33	P-XTN3+8B	Screw, 6855/6955
C-34	P-04EZAZV007	Sensor Knob, 6855/6955
C-35	P-33MZAZ0000	LED Lens, 6855/6955

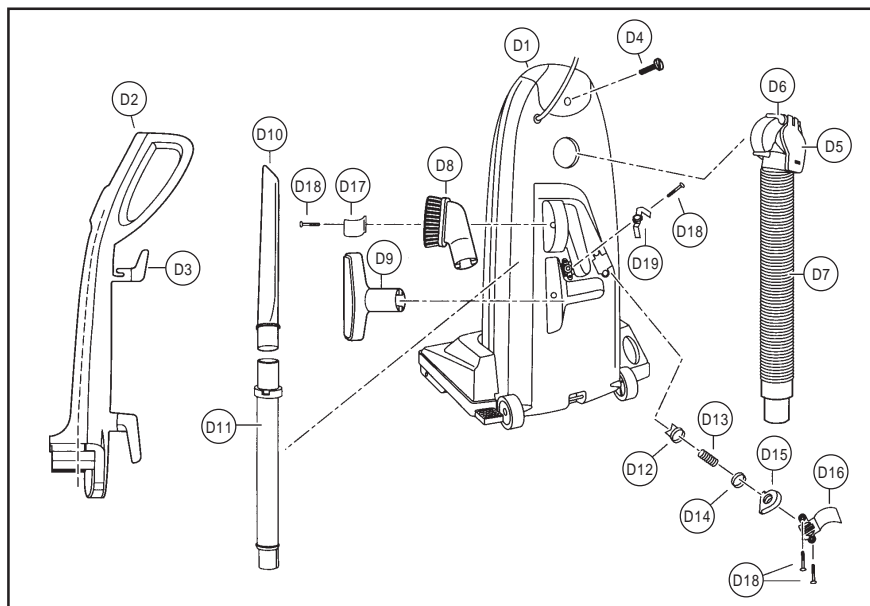

PARTS LIST (HANDLE, ATTACHMENTS)

KEY	PART NO.	DESCRIPTION
D-1	P-75275	Dust Compartment, 6815
D-1	NLA	Dust Compartment, 6810/6855/6915/6955
D-2	P-70140	Handle Ass'y, 6815/6855/6915/6955
D-2	P-95BYZZV07	Handle Ass'y, 6810
D-3	P-70842	Upper Cord Hook
D-4	P-73BZA000	Screw (Handle)
D-5	P-75690	Suction Inlet Cover
D-6	P-75419	Suction Inlet Packing
D-7	P-73660	Hose Ass'y
D-8	P-53020	Dusting Brush
D-9	P-52020	Upholstery Nozzle

KEY	PART NO.	DESCRIPTION
D-10	P-54017	Crevice Tool
D-11	P-50025	Extension Wand Unit
D-12	P-68K-D20	Protector Case
D-13	P-76865	Protector Spring
D-14	P-50521	Protector
D-15	P-50520	Protector Supporter
D-16	P-75920	Hose Hook
D-17	P-75925	Wand Holder
D-18	P-77020	Screw
D-19	P-75932	Holder