

This Owner's Manual is provided and hosted by [Appliance Factory Parts](#).



LG LSN120HYV Owner's Manual

[Shop genuine replacement parts for LG LSN120HYV](#)



[Find Your LG Air Conditioner Parts - Select From 2330 Models](#)

----- Manual continues below part list -----

Available Replacement Parts for LG LSN120HYV

4280A20004M	Bearing
6871A20259D	Sub Pcb Assembly
4681A20042E	Motor Assembly,dc,stepping
ADQ68719501	Air Cleaner Filter Assembly
EAU62004010	Motor Assembly,dc,indoor
ABW73492404	Chassis Assembly
AKB74375403	Remote Control



Internal Use Only

<http://biz.lgservice.com>

Room Air Conditioner

SVC MANUAL(Exploded View)

MODEL : LSN090HYV / LSU090HYV
LSN120HYV / LSU120HYV

CAUTION

Before Servicing the unit, read the safety precautions in General SVC manual.
Only for authorized service personnel.

Product Specifications

Models		Unit	LSN / LSU090HYV	LSN / LSU120HYV
Cooling Capacity		kW	0.30~2.63~3.80	0.30~3.51~4.04
		Btu/h.	1,023~9,000~12,966	1,023~12,000~13,785
Heating Capacity		kW	0.30~3.22~6.50	0.30~3.98~6.50
		Btu/h.	1,023~11,000~20,472	1,023~13,600~22,178
Power Input	Cooling/Heating	W	550/740	850/960
Running Current	Cooling/Heating	A	2.5/3.4	3.8 / 4.3
Starting Current	Cooling/Heating	A	2.5/3.4	3.8 / 4.3
EER		W/W	4.81	4.13
		Btu/h.W	16.4	14.1
SEER			28	26
HSPF			12	11.5
Power Supply		Ø / V / Hz	1/208-230/60	1/208-230/60
Power Factor		%	98.7	97.7
Air Flow Rate	Indoor,Max	m³/min(CFM)	15.5(547)	15.5(547)
	Outdoor,Max	m³/min(CFM)	33(1,165)	33(1,165)
Moisture Removal		l/h.	1.5	1.7
Sound Level	Indoor,H/M/L/Sleep	dB(A)±3	39 / 34 / 26 / 17	39 / 34 / 26 / 17
	Outdoor,Max	dB(A)±3	51	51
Refrigerant & Charge (at 7.5 m)		g(oz)	R410A, 1,250(44.1)	R410A, 1,250(44.1)
Additional Refrigerant charge		g/m(oz/ft)	20(0.22)	20(0.22)
Compressor	Type		2P Rotary	2P Rotary
	Model		GKT128MA	GKT128MA
	Motor Type		Hermetic Motor Compressor	Hermetic Motor Compressor
	Oil Type		FVC68D	FVC68D
	Oil Charge	cc	450	450
	O.L.P. name		-	-
Fan(Indoor)	Type		Cross Flow Fan	Cross Flow Fan
	Motor Output	W	20	20
Fan(Outdoor)	Type		Propeller, Fan	Propeller, Fan
	Motor Type		BLDC	BLDC
	Motor Output	W	85	85
Circuit Breaker*		A	15	15
Power Supply Cable		No.*mm²	3*1.0	3*1.0
Power and Transmission Cable No.*mm²		No.*mm²	4*1.0 (Including Earth)	4*1.0 (Including Earth)
Piping Connections	Liquid Side	mm(in)	6.35(1/4)	6.35(1/4)
	Gas Side	mm(in)	9.52(3/8)	9.52(3/8)
Drain Hose(O.D / I.D.)		mm(in)	21.5 / 16.0(0.85 / 0.63)	21.5 / 16.0(0.85 / 0.63)
Dimensions	Indoor (W*H*D)	mm	875*295*235	875*295*235
		inch	34.4*11.6*9.25	34.4*11.6*9.25
	Outdoor (W*H*D)	mm	870*655*320	870*655*320
		inch	34.2*25.8*12.6	34.2*25.8*12.6
Net Weight	Indoor	kg(lbs)	11.5(25.3)	11.5(25.3)
	Outdoor	kg(lbs)	43(94.8)	43(94.8)
Gross Weight	Indoor	kg(lbs)	13.0(28.6)	13.0(28.6)
	Outdoor	kg(lbs)	45(99.2)	45(99.2)
Operation Range	Cooling(Outdoor)	°C(°F)	-10~48(14~118.4)	-10~48(14~118.4)
	Heating(Outdoor)	°C(°F)	-10~24(14.0~75.2)	-10~24(14.0~75.2)
Piping Length (Min/Max)		m(ft)	3(9.84) / 15(49.2)	3(9.84) / 15(49.2)
Chargeless		m(ft)	-	-
Max. Elevation Difference		m(ft)	10(32.8)	10(32.8)
Tool Code(Chassis)	Indoor + Outdoor		SM + UE	SM + UE
Functions	Temperature Control		Thermistor	Thermistor
	Allergy free filter		-	-
	Plasma Filter		○	○
	Prefilter(washable/anti-fungus)		○	○
	Auto Clean		○	○
	CHAOS Wind(Auto Wind)		○	○
	Steps, Fan/Cool/Heat		5/6/6	5/6/6
	Airflow Direction Control(up& Down)		Auto	Auto
	Airflow Direction Control(left & right)		Auto	Auto
	Remote Controller Type		Better	Better
	Setting Temperature	Cooling	18°C ~ 30°C	18°C ~ 30°C
	Range	Heating	16°C ~ 30°C	16°C ~ 30°C
	Auto Operation (Micom Control)		-	-
	Auto Changeover (Micom Control)		○	○
	Self Diagnosis		○	○
	Timer		24h, On/Off	24h, On/Off
	Sleep Operation		○	○
	Soft Dry Operation		○	○
	Restart Delay(minute)		3	3
	Deice Control(Defrost)		○	○
	Hot Start		○	○
	Jet Cool		○	○
	Low Ambient Operation		○	○
	Special Function		Water Level Sensor	Water Level Sensor

Note:

○ : Applied, - : No relation

* For circuit breaker rating, please conform to local standards wherever necessary.

* Some of functions are slightly different depending upon models.

* The specification may be subject to change without notice for purpose of improvement.

2. Piping Diagrams

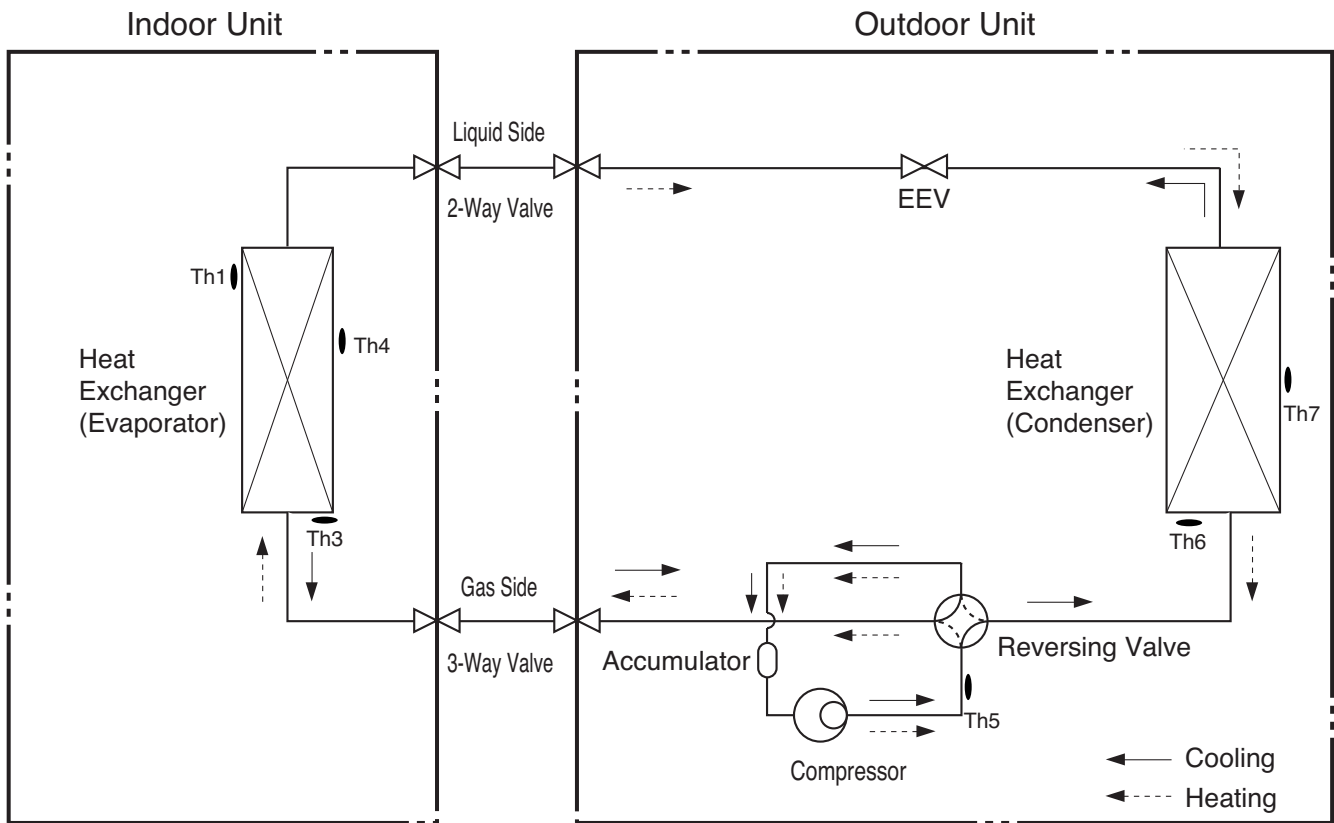

LOC.	Description	PCB Connector
Th1	Thermistor for suction air temperature	CN-TH1(Indoor)
Th3	Water level sensor (Option)	CN-TH2(Indoor)
Th4	Thermistor for evaporator middle temperature	CN-TH3(Indoor)
Th5	Thermistor for discharge pipe temperature	CN-TH2(OUTDOOR)
Th6	Thermistor for condensing temperature	CN-TH1(OUTDOOR)
Th7	Thermistor for outdoor air temperature	CN-TH1(OUTDOOR)

※ EEV : Electronic Expansion Valve

3. Wiring Diagrams

Indoor Unit

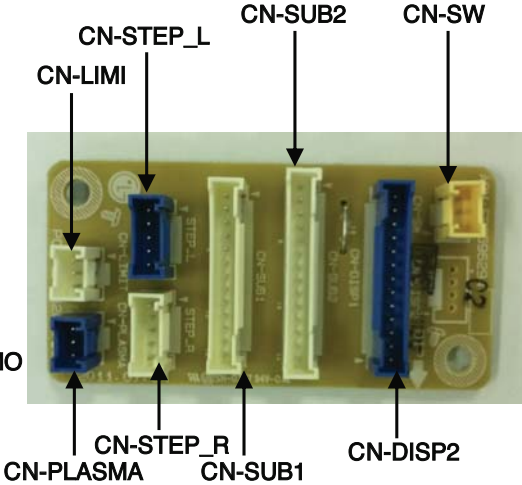
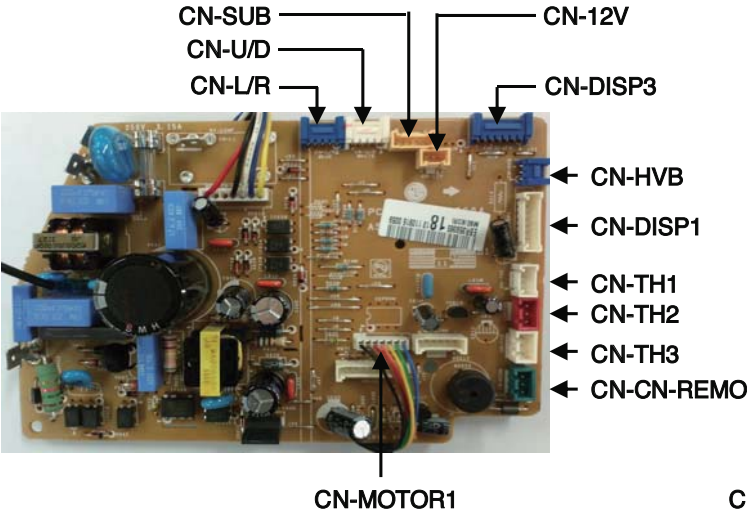
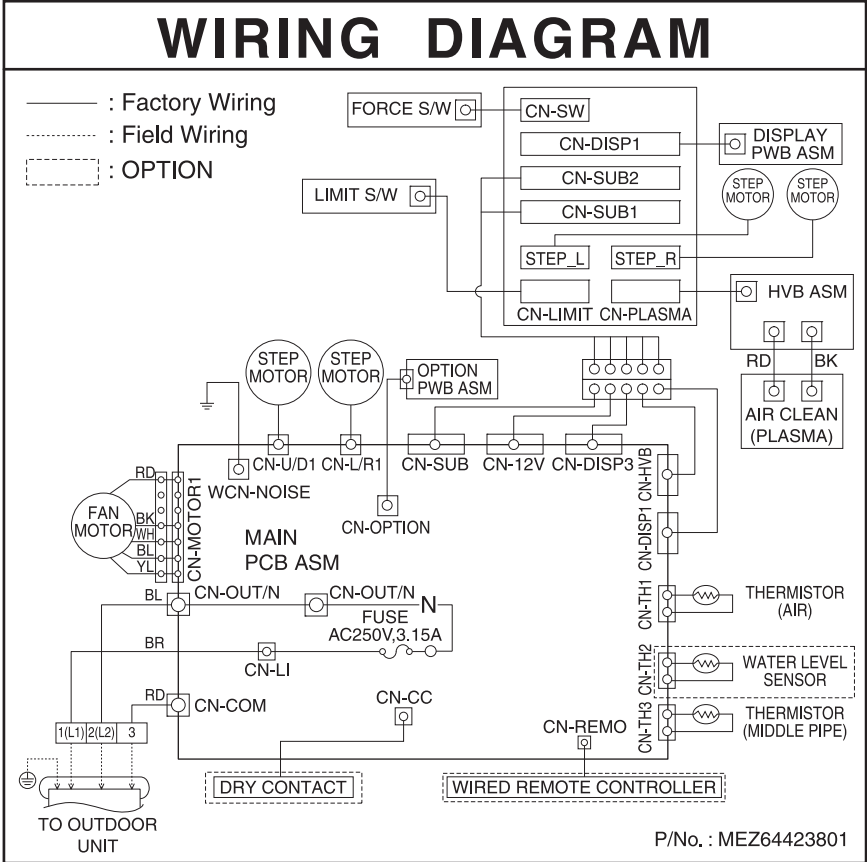

Outdoor Unit

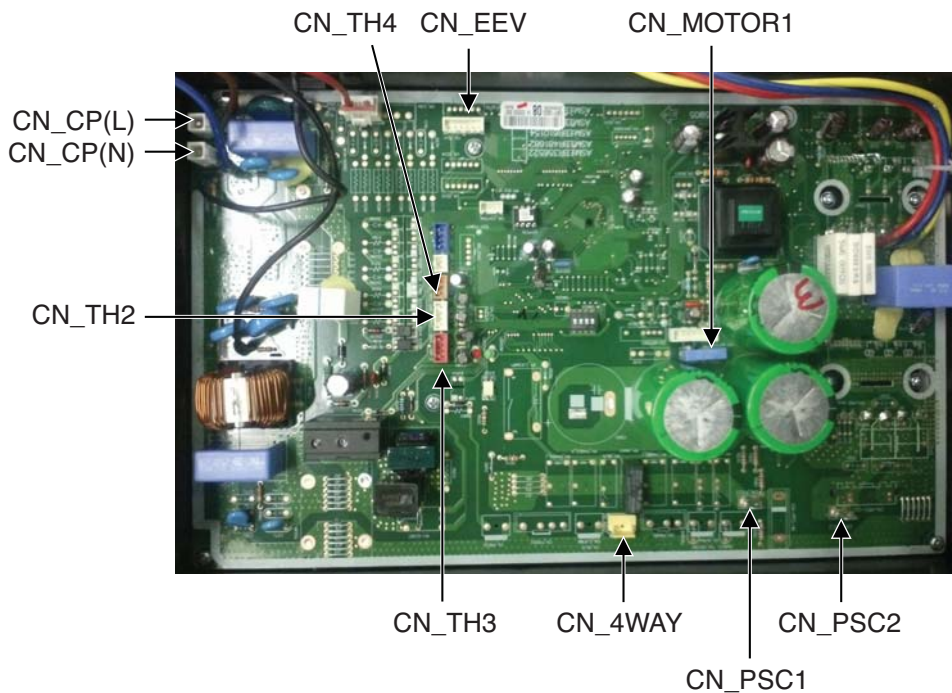
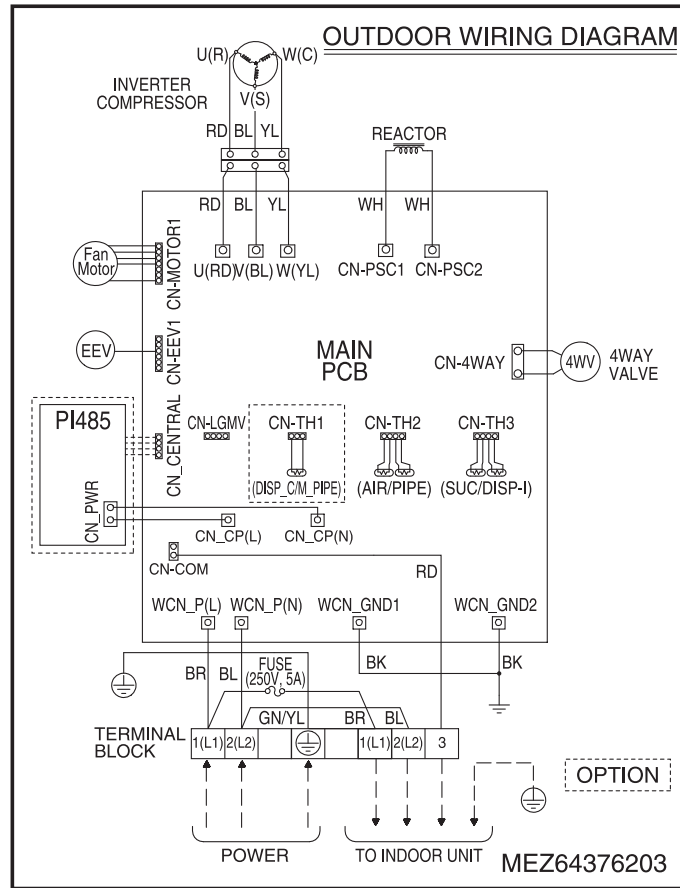

Exploded View

Indoor Unit

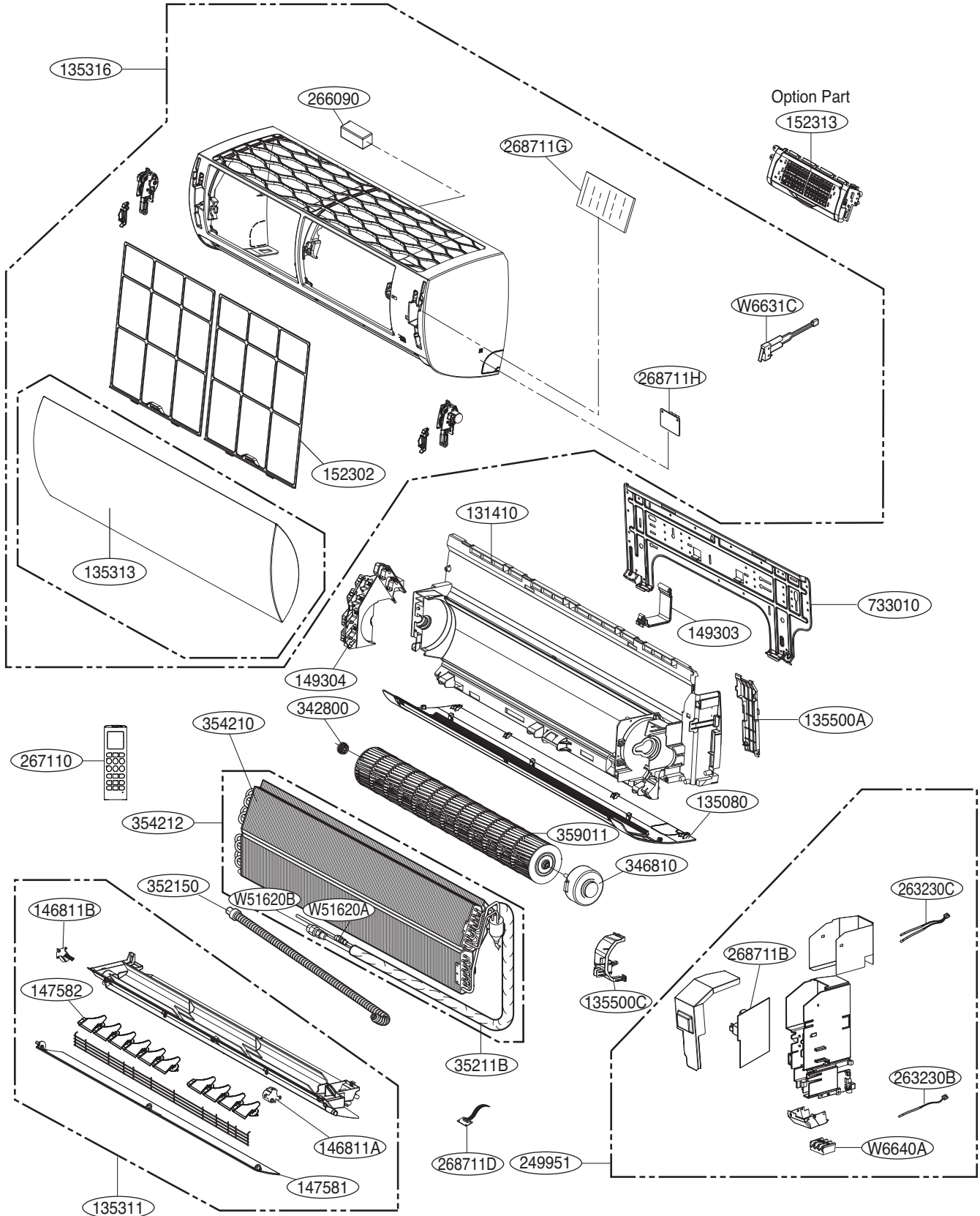

Outdoor Unit

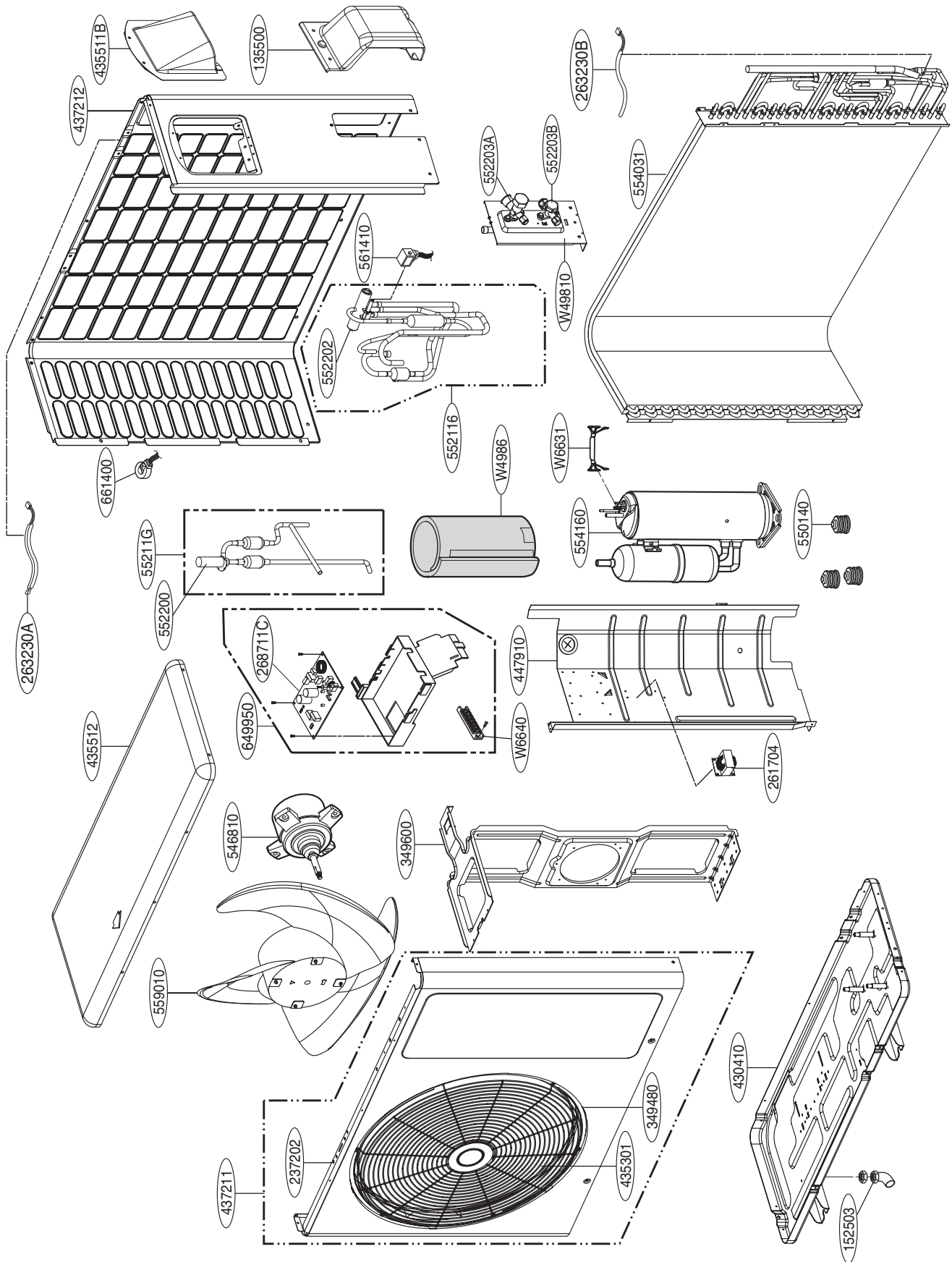



P/NO : MFL67501901

FEB. 2012