



ENGLISH

FRANÇAIS

ESPAÑOL

OWNER'S MANUAL AIR CONDITIONER

Please read this manual carefully before operating your set and retain it for future reference.

TYPE : Ceiling Cassette

P/NO : MFL42619114

<http://www.lghvac.com>

www.lg.com

TABLE OF CONTENTS

A. Safety Precautions3
B. Product Introduction6
C. Operating instructions10
D. Maintenance and Service35



FOR YOUR RECORDS

Write the model and serial numbers here:

Model # _____

Serial # _____

You can find them on a label on the side of each unit.

Dealer's Name _____

Date Purchased _____

- Staple your receipt to this page in the event you need it to prove date of purchase or for warranty issues.



READ THIS MANUAL

Inside you will find many helpful hints on how to use and maintain your air conditioner properly. Just a little preventive care on your part can save you a great deal of time and money over the life of your air conditioner.

You'll find many answers to common problems in the chart of troubleshooting tips. If you review our chart of

Troubleshooting Tips first, you may not need to call for service at all.



PRECAUTION

- Contact the authorized service technician for repair or maintenance of this unit.
- Contact the installer for installation of this unit.
- The air conditioner is not intended for use by young children or invalids without supervision.
- Young children should be supervised to ensure that they do not play with the air conditioner.
- When the power cord is to be replaced, replacement work shall be performed by authorized personnel only using only genuine replacement parts.
- Installation work must be performed in accordance with the National Electric Code by qualified and authorized personnel only.



Safety Precautions

To prevent injury to the user or other people and property damage, the following instructions must be followed.

- Incorrect operation due to ignoring instruction will cause harm or damage. The seriousness is classified by the following indications.

⚠ WARNING This symbol indicates the possibility of death or serious injury.

⚠ CAUTION This symbol indicates the possibility of injury or damage.

⚠ WARNING

Always ground the product.

- There is a risk of electric shock.

For electrical work, contact the dealer, seller, a qualified electrician, or an Authorized Service Center. Do not disassemble or repair the product by yourself.

- There is risk of fire or electric shock.

Use the correctly rated breaker or fuse.

- There is risk of fire or electric shock.

Do not install the product on a defective installation stand. Be sure that the installation area does not deteriorate with age.

- It may cause product to fall.

Be sure to check the refrigerant to be used. Please read the label on the product.

- Incorrect refrigerant used can prevent the normal operation of the unit.

Do not place a heater or other heating appliances near the power cable.

- There is risk of fire and electric shock.

Do not use a defective or underrated circuit breaker. Use the correctly rated breaker and fuse.

- There is risk of fire or electric shock .

Always ground the product as per the wiring diagram. Do not connect the ground wire to gas or water pipes lightning rod or telephone ground wire.

- There is risk of fire or electric shock.

Do not modify or extend the power cable. If the power cable or cord has scratches or skin peeled off or deteriorated then it must be replaced.

- There is risk of fire or electric shock.

Never install the outdoor unit on a moving base or a place from where it can fall down.

- The falling outdoor unit can cause damage or injury or even death of a person.

Don't use a power cord, a plug or a loose socket which is damaged.

- Otherwise it may cause a fire or electrical shock.

Do not allow water to run into electric parts. Install the unit away from water sources.

- There is risk of fire, failure of the product, or electric shock.

Do not use a multi consent. Always use this appliance on a dedicated circuit and breaker.

- Otherwise it can cause electric shock or fire.

Install the panel and the cover of control box securely.

- There is risk of fire or electric shock due to dust , water etc.

For installation, removal or reinstall , always contact the dealer or an Authorized Service Center.

- There is risk of fire, electric shock, explosion, or injury.

When the product is soaked (flooded or submerged) in water , contact an Authorized Service Center for repair before using it again.

- There is risk of fire or electric shock.

Do not touch , operate, or repair the product with wet hands. Hold the plug by hand when taking out

- There is risk of electric shock or fire.

Do not store or use or even allow flammable gas or combustibles near the product.

- There is risk of fire.

Safety Precautions

Indoor/outdoor wiring connections must be secured tightly and the cable should be routed properly so that there is no force pulling the cable from the connection terminals.

- Improper or loose connections can cause heat generation or fire.

In outdoor unit the step-up capacitor supplies high voltage electricity to the electrical components. Be sure to discharge the capacitor completely before conducting the repair work.

- An charged capacitor can cause electrical shock.

Do not use the product in a tightly closed space for a long time. Perform ventilation regularly.

- Oxygen deficiency could occur and hence harm your health.

Ventilate the product room from time to time when operating it together with a stove, or heating element etc.

- Oxygen deficiency can occur and hence harm your health.

Take care to ensure that nobody especially kids could step on or fall onto the outdoor unit.

- This could result in personal injury and product damage.

Do not plug or unplug the power supply plug to turn the unit ON/OFF .

- There is risk of fire or electric shock.

Safely dispose off the packing materials. Like screws, nails, batteries, broken things etc after installation or svc and then tear away and throw away the plastic packaging bags.

- Children may play with them and cause injury.

When installing the unit, use the installation kit provided with the product.

- Otherwise the unit may fall and cause severe injury.

Do not open the front grille of the product during operation. (Do not touch the electrostatic filter, if the unit is so equipped.)

- There is risk of physical injury, electric shock, or product failure.

Turn the main power off and unplug the unit when cleaning or repairing the product.

- There is risk of electric shock.

Take care to ensure that power cable could not be pulled out or damaged during operation.

- There is risk of fire or electric shock.

Make sure to check that the power cable plug is not dirty, loose or broken and then only insert the plug completely.

- Dirty, loose or broken power plug can cause electric shock or fire.

Be sure to use only those parts which are listed in the svc parts list. Never attempt to modify the equipment.

- The use of inappropriate parts can cause an electrical shock, excessive heat generation or fire.

If strange sounds, smell or smoke comes from product. Immediately turn the breaker off or disconnect the power supply cable.

- There is risk of electric shock or fire.

When the product is not to be used for a long time, disconnect the power supply plug or turn off the breaker.

- There is risk of product damage or failure, or unintended operation.

Do not place ANYTHING on the power cable.

- There is risk of fire or electric shock.

When flammable gas leaks, turn off the gas and open a window for ventilation before turn the product on.

- Do not use the telephone or turn switches on or off. There is risk of explosion or fire.

CAUTION

Two or more people must lift and transport the product.

- Avoid personal injury.

Keep level even when installing the product.

- To avoid vibration or noise.

Do not install the product where it will be exposed to sea wind (salt spray) directly.

- It may cause corrosion on the product.

Do not install the product where the noise or hot air from the outdoor unit could damage or disturb the neighborhoods.

- It may cause a problem for your neighbors and hence dispute.

Install the drain hose to ensure that the condensed water is drained away properly.

- A bad connection may cause water leakage.

Always check for gas (refrigerant) leakage after installation or repair of product.

- Low refrigerant levels may cause failure of product.

Do not use the product for special purposes, such as preserving foods, works of art, etc. It is a consumer air conditioner, not a precision refrigeration system.

- There is risk of damage or loss of property.

Do not block the inlet or outlet of air flow.

- It may cause product failure.

Use a soft cloth to clean. Do not use harsh detergents, solvents or splashing water etc .

- There is risk of fire, electric shock, or damage to the plastic parts of the product.

Do not touch the metal parts of the product when removing the air filter.

- There is risk of personal injury.

Do not step on or put anything on the product. (outdoor units)

- There is risk of personal injury and failure of product.

Always insert the filter securely after cleaning. Clean the filter every two weeks or more often if necessary.

- A dirty filter reduces the efficiency.

Do not insert hands or other objects through the air inlet or outlet while the product is operating.

- There are sharp and moving parts that could cause personal injury.

Be cautious when unpacking and installing the product.

- Sharp edges could cause injury.

If the refrigerant gas leaks during the repair, do not touch the leaking refrigerant gas.

- The refrigerant gas can cause frostbite (cold burn)

Do not tilt the unit when removing or uninstalling it.

- The condensed water inside can spill .

Do not mix air or gas other than the specified refrigerant used in the system .

- If air enters the refrigerant system, an excessively high pressure results, causing equipment damage or injury.

If the refrigerant gas leaks during the installation, ventilate the area immediately.

- Otherwise it can be harmful for your health.

Dismantling the unit, treatment of the refrigerant oil and eventual parts should be done in accordance with local and national standards.

Replace the all batteries in the remote control with new ones of the same type. Do not mix old and new batteries or different types of batteries.

- There is risk of fire or product failure.

Do not recharge or disassemble the batteries. Do not dispose off batteries in a fire.

- They may burn or explode.

If the liquid from the batteries gets onto your skin or clothes, wash it well with clean water. Do not use the remote if the batteries have leaked.

- The chemicals in batteries could cause burns or other health hazards.

If you eat the liquid from the batteries, brush your teeth and see doctor. Do not use the remote if the batteries have leaked.

- The chemicals in batteries could cause burns or other health hazard.

Do not let the air conditioner run for a long time when the humidity is very high and a door or a window is left open.

- Moisture may condense and wet or damage furniture.

Do not expose your skin or kids or plants to the cool or hot air draft.

- This could harm to your health.

Do not drink the water drained from the product.

- It is not sanitary and could cause serious health issues.

Use a firm stool or ladder when cleaning, maintaining or repairing the product at an height.

- Be careful and avoid personal injury.

Product Introduction

Here is a brief introduction of the indoor and outdoor units. Please see the information specific to your indoor unit type.

Indoor Units

[Ceiling Cassette Type]

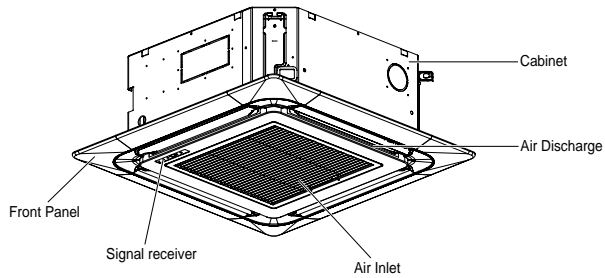

Outdoor Unit

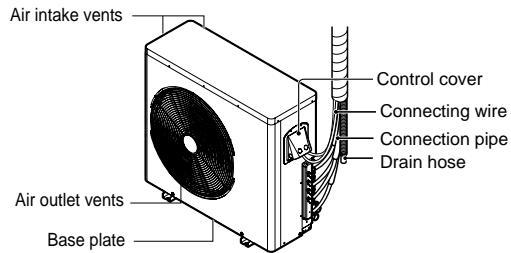

* The figure can be changed according to model.

Operation Indication Lamps

[Ceiling Cassette Type]

- ⓘ **On/Off** : Lights up during the system operation.
- 🔧 **Filter Sign** : Lights up after 2400 hours from the time of first operating unit.
- 🕒 **Timer** : Lights up during Timer operation.
- ❄️ **Defrost Mode** : Lights up during Defrost Mode or Hot Start operation.(Heat pump model only)
 - **Forced** : To operate the unit when the remote control can't be used for any reason.

* **Hot start operation:** Stops the indoor fan in heating operation for minutes to prevent cold air from blowing out from unit.

* In defrost mode unit stops heating operation for few minutes to remove formation of ice on the heat exchanger coils to maintain the efficiency.

Operating Method

1. The signal receiver is inside the unit.
2. Aim the remote controller towards the unit to operate it.
There should not be any blockage in between.

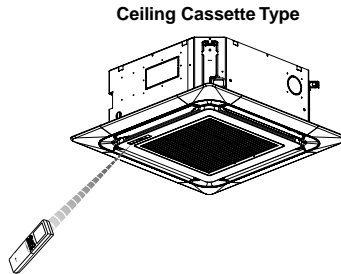

Wired Remote Controller

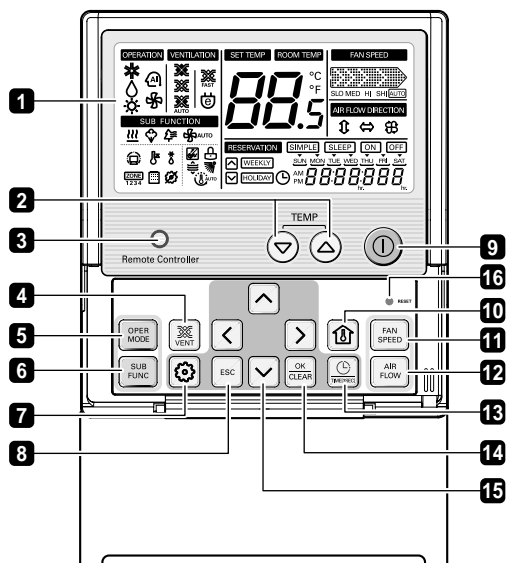

- 1** OPERATION INDICATION SCREEN
- 2** SET TEMPERATURE Button
- 3** WIRELESS REMOTE CONTROLLER RECEIVER
 - Some products don't receive the wireless signals.
- 4** VENTILATION Button
- 5** OPERATION MODE SELECTION Button
- 6** SUBFUNCTION Button
- 7** FUNCTION SETTING Button
- 8** EXIT Button
- 9** ON/ OFF Button
- 10** ROOM TEMPERATURE Button
- 11** FAN SPEED Button
- 12** AIR FLOW Button
- 13** RESERVATION/ TIME SETTING Button
- 14** SETTING/ CANCEL Button
- 15** UP, DOWN, LEFT, RIGHT Button
- 16** RESET Button

NOTE

- * Display temperature can be different from actual room temperature if the remote controller is installed at the place where sun-rays are falling directly or the place nearby heat source.
- * The actual product can be different from above contents depending upon model type.

Wireless Remote Controller

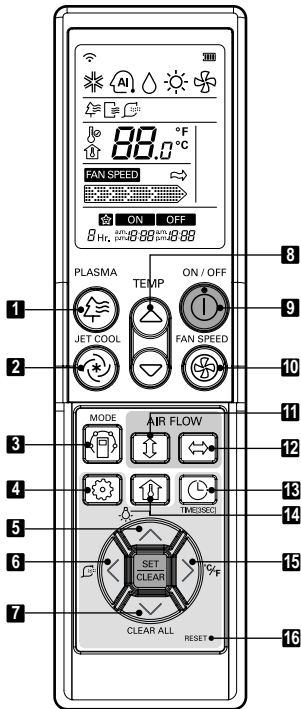



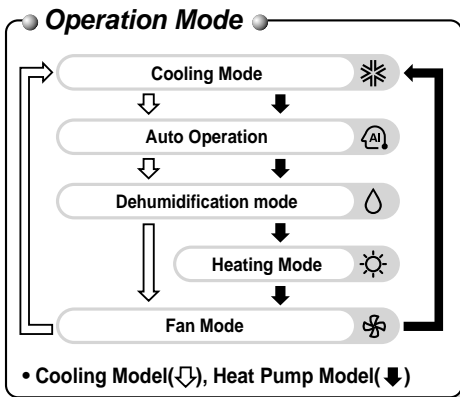



- 1 PLASMA Button (Optional)**
Used to start or stop the plasma-purification function.
- 2 JET COOL Button**
Speed cooling operates super high fan speed.
- 3 OPERATION MODE SELECTION Button**
Used to select the operation mode.
- 4 FUNCTION SETTING Button**
Used to set or clear Auto Clean or Amart Clean.
- 5 LCD LUMINOSITY Button (Optional)**
Used to adjust LCD luminosity
- 6 SMART CLEAN Button (Optional)**
Used to start or stop Smart Clean.
- 7 CLEAR ALL Button**
Used to clear all timer.
- 8 ROOM TEMPERATURE SETTING Button**
Used to select the room temperature.
- 9 ON/OFF Button**
Used to turn on/off the unit.
- 10 INDOOR FAN SPEED SELECTION Button**
Used to select fan speed in four steps low, medium, high and chaos.
- 11 UP/DOWN AIRFLOW Button**
Used to stop or start louver movement and set the desired up/down airflow direction.
- 12 LEFT/RIGHT AIRFLOW Button(Optional)**
Used to set the desired left/right(horizontal) airflow direction.
- 13 TIMER AND TIME SETTING Button**
Used to set the time of starting or stopping and sleeping operation.
- 14 ROOM TEMPERATURE CHECKING Button**
Used to check the room temperature.
- 15 °C/°F SWITCH Button**
Used to switch temperature reading from Celsius to Fahrenheit.
- 16 RESET Button**
Used to reset the remote controller.



Operating instructions

Cooling Mode - Standard Operation

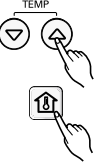

1. Wired Remote Controller

1	Press  button to turn on the indoor.	
2	Press  button to select Cooling operation mode.	
3	Adjust the desired temperature by pressing   buttons. Press  button to check the Room temperature. When setting the desired temperature higher than room temperature, only ventilation wind is blow out instead of cooling wind.	

❖ Setting Temp Range : 18°C~30°C.

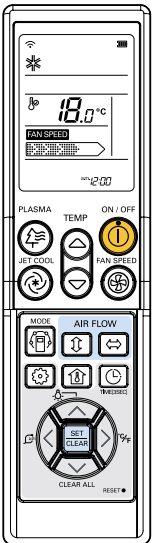
2. Wireless Remote Controller









1	Press the ON/OFF button. The unit will respond with beep sound.	 ON / OFF
2	Press MODE button to select Cooling Mode.	 MODE
3	Set the desired temperature by pressing TEMP button. Press ROOM TEMPERATURE CHECKING button to check the room temperature. When setting the desired temperature is higher than room temperature, cooling wind isn't blow out.	 To raise the temperature To lower the temperature

* Setting Temp. Range : 18~30°C(64~86°F)

Cooling Mode - Power Cooling

It makes the room cool using pleasant and fresh air quickly

1. Wired Remote Controller

- | | |
|----------|---|
| 1 | Press  button to turn on the indoor.  |
| 2 | Press  button to select Cooling operation mode.  |
| 3 | Press  button continuously until "Po" displayed.  |

2. Wireless Remote Controller

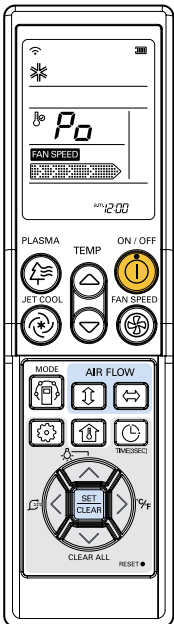

- 1** Press the ON/OFF button.
The unit will respond with beep sound.

ON / OFF



- 2** Press MODE button to select Cooling Mode.

MODE



- 3** Press the JET COOL button. The unit will operate in super high fan speed in cooling mode.
* Wall mounted models operate power cooling mode for 30 minutes.

JET COOL



- 4** To cancel the Power cooling Mode press the Jet Cool button or the fan button or the room temperature setting button again and the unit will operate in high fan speed in cooling mode.

JET COOL



or

FAN SPEED









or

TEMP



Heating Mode

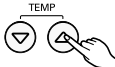

1. Wired Remote Controller

- 1 Press  button to turn on the indoor. 
- 2 Press  button to select Heating mode. 
- 3 Adjust the desired temperature by pressing   buttons. 
 When setting the desired temperature lower than room temperature, there is only ventilation wind.

❖ Setting Temp Range : 16°C~30°C.

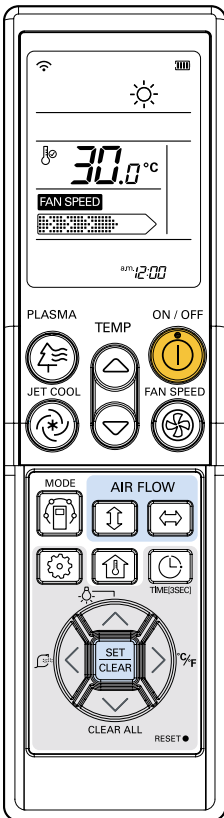
2. Wireless Remote Controller









- 1 Press the ON/OFF button. The unit will respond with beep sound. 
- 2 Press MODE button to select Heating Mode. 
- 3 Set the desired temperature by pressing TEMP button. Press ROOM TEMPERATURE CHECKING button to check the room temperature. When setting the desired temperature is lower than room temperature, heating wind isn't blow out. 
 - To raise the temperature
 - To lower the temperature

*** Setting Temp. Range in Heating Mode : 16~30°C (60°F~86°F)**
- 4 Set the fan speed again. You can select the fan speed in four steps—low, medium, high, or chaos. Each time the button is pressed, the fan speed mode is shifted. 

Dehumidification Mode

1. Wired Remote Controller

<p>1 Press  button to turn on the indoor.</p>	
<p>2 Press  button to select Dehumidification mode The temperature setting can not be adjusted during operation this mode.</p>	
<p>3 Press the  button to select airflow rate SLO → LO ' MED → HI → (NONE) → </p> <p>(The lists depends on products function)</p> <p>❖ NONE : Power level of Fan Speed</p>	

2. Wireless Remote Controller

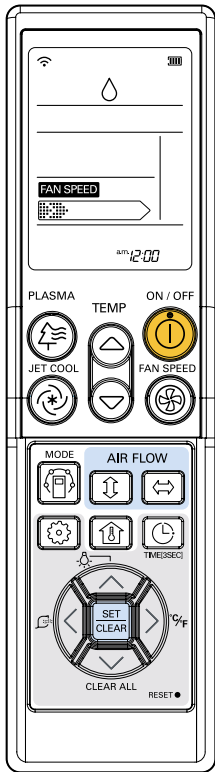

1 Press the ON/OFF button.
The unit will respond with beep sound.

ON / OFF

2 Press MODE button to select Dehumidification Mode.

MODE

3 Set the fan speed. You can select the fan speed in four steps - low, medium, high, or chaos. Each time the button is pressed, the fan speed mode is shifted.

FAN SPEED





During Dehumidification Mode

- If you select the dehumidification mode on the operation selection button, the indoor unit starts to run the dehumidification function, automatically setting the room temp. and air volume to the best condition for dehumidification based on the sensed room temp. In this case, the setting temp. is not displayed in the Remote Controller and you are not able to control the room temp. either.
- During the healthy dehumidification function, the air volume is automatically set according to the algorithm responding to the current room temp. and makes the room condition healthy and comfortable even in the high humidity season.

In rainy season or high humidity climate, it is possible to operate simultaneously dehumidifier and cooling mode to remove humidity effectively.

Auto Changeover Mode



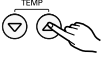

1. Wired Remote Controller

- 1 Press  button to turn on the indoor. 
- 2 Press  button to select Auto Changeover Mode. 
- 3 The setting temperature as the right side picture can be set in both cooling/ heating model. 

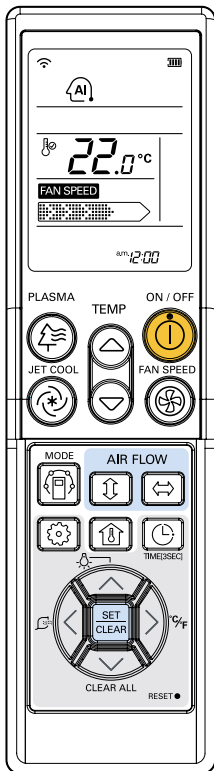
❖ Setting Temp Range : 18°C~30°C.

2. Wireless Remote Controller









- 1 Press the ON/OFF button. The unit will respond with beep sound. 
- 2 Press MODE button to select Auto Changeover Mode. 
- 3 Set the desired room temperature.
* Setting Temp. Range in Auto Changeover Mode : 18~30°C (64~86°F)
 To raise the temperature
To lower the temperature
- 4 You can select the fan speed in four steps-low, medium, high and chaos. Each time the button is pressed, the fan speed mode is shifted. 

During Auto changeover Mode

The air conditioner changes the operation mode automatically to keep indoor temperature. When room temperature vary over $\pm 2^{\circ}\text{C}$ (4°F) with respect to setting temperature, air conditioner keeps the room temperature within $\pm 2^{\circ}\text{C}$ (4°F) with respect to setting temperature by auto changeover mode.



Fan Mode



1. Wired Remote Controller

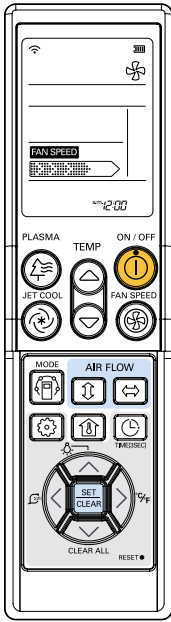

- 1 Press  button to turn on the indoor. 
- 2 Press  button to select Fan mode 
- 3 Press the  button to select airflow rate SLO → LO → MED → HI → (NONE) →  (The lists depends on products function) 

2. Wireless Remote Controller



- 1 Press the ON/OFF button. The unit will respond with beep sound.  

- 2 Press MODE button to select Fan Mode.  

- 3 Set the fan speed again. You can select the fan speed in four steps—low, medium, high, or chaos. Each time the button is pressed, the fan speed mode is shifted.  

Natural Wind by the chaos Logic

- For more fresh feeling than other fan speed, press the Indoor Fan Speed Selector and set to chaos mode. In this mode, the wind blows like natural breeze by automatically changing fan speed according to the chaos logic.







During Fan Mode

- The outdoor compressor doesn't work. Have a function to circulate the indoor as it sends out the air that doesn't have much temperature difference with indoor.

Ariflow Setting

We can simply adjust the desired airflow rate

1. Wired Remote Controller

- 1** Press  buttons to set the desired airflow direction.
-  → (NONE) →   →  → 
 - Display of these lists depends on products function.
 - ❖ NONE : Released swirl

2. Wireless Remote Controller

Up/Down Airflow Direction Control

1. Press the ON/OFF button to start the unit.
2. Press UP/DOWN AIRFLOW button and the louvers will swing up and down.
Press the UP/DOWN AIRFLOW button again to set the vertical louver at the desired airflow direction.





Left/Right Airflow Direction Control

1. Press the ON/OFF button to start the unit.
2. Press the LEFT/RIGHT AIRFLOW button and the louvers will swing left and right. Press the Horizontal Airflow Direction Control Button again to set the horizontal louver at the desired airflow direction.





<Ariflow Setting Table>

Symbol	Description
	Swirl : vane paired open cross
	Up-Down : Vane move from up to down automatically and continuously
	Left-Right : Vane move from left to right automatically and continuously

* Some functions may not be operated and displayed depending on the product type.

Temperature setting/ room temperature check

1. Wired Remote Controller

- 1** We can simply adjust the desired temperature.
- Press the   buttons to adjust the desired temperature.

 : Increase 1°C per one time pressing

 : Decrease 1°C per one time pressing

Room temp: Indicate the current room temperature.

Set temp: Indicate the temperature that user want to set.

Depend on what kind of controller, the desired temperature can be adjusted at 0.5°C.

Cooling operation: The cooling mode doesn't work if desired temperature is higher than room temperature Please lower the desired temperature.

Heating operation: The heating mode doesn't work if desired temperature is higher than room temperature Please lower the desired temperature.

- 2** Whenever press  button, the room temperature will be displayed within 5 seconds.

After 5 seconds, it turns to display the desired temperature.

Because of location of remote controller, the real room temperature and the this displayed value can be different

2. Wireless Remote Controller

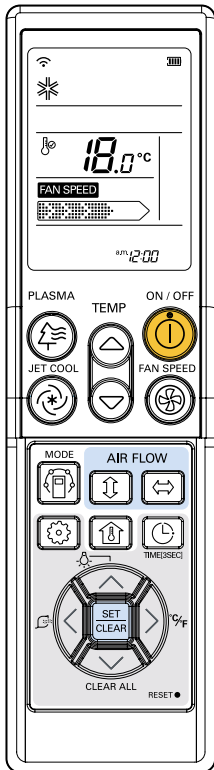

We can simply adjust the desired temperature

- Press the buttons to adjust the desired temperature

TEMP



: Increase 1°C or 2°F per one time pressing

: Decrease 1°C or 2°F per one time pressing

Room temp: Indicate the current room temperature

Set temp: Indicate the temperature that user want to set

<Cooling Mode>

The cooling mode doesn't work if desired temperature is higher than room temperature Please lower the desired temperature

<Heating Mode>

The heating mode doesn't work if desired temperature is lower than room temperature Please increase the desired temperature









Whenever press button, the room temperature will be displayed within 5 seconds.

After 5 seconds, it turns to display the desired temperature.

Because of location of remote controller, the real room temperature and the this displayed value can be different.

Sub function : Plasma Purification(Optional)

1. Wired Remote Controller

1	Repeat pressing  button until  icon flash.	
2	Operate or cancel Plasma Purification function by pressing  button. ( icon appears/disappears on SUB FUNCTION display part up to selection)	
3	After setting, press  button to exit.	

2. Wireless Remote Controller

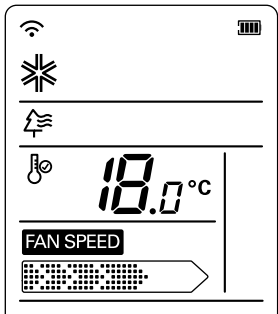

1 Press the ON/OFF button.
The unit will respond with beep sound.

ON / OFF



2 Press the PLASMA button. Plasma Purification will start when the button is pressed and stop when the button is pressed again.

PLASMA



PLASMA Purification only

The screenshot shows the remote control display with the Plasma Purification icon (a tree with a lightning bolt) highlighted. The 'FAN SPEED' indicator is also visible.

If you press the PLASMA button, Plasma Purification operates.

PLASMA









- Plasma filter is a technology developed by LG to get rid of microscopic contaminants in the intake air generating a plasma of high charge electrons. This plasma kills and destroys the contaminants completely to provide clean and hygienic air.
- This function can be used in any operation mode and any fan speed can be used while plasma filter is functioning.

When turn the machine off, Plasma function is off (And also off when restart indoor)
 In case of such model that has no Plasma sub function, it doesn't appear when pressing  button.

Function setting : Child Lock

This function is to prevent children or other people from using indoor.





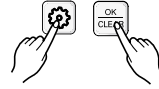







- Press  button. 
- Repeat pressing  button until the  icon flash.
- When the button flashing, press  button to set this function. 
- When setting this function,  icon will be displayed whenever entering any operation except for Room temperature access. However, it is possible to control normally by wireless remote controller.

To release this setting, keep pressing  button until  icon flash and then enter  button.



Function Setting : Mode Change Temp

This function is to set converting temp. of Auto Changeover

1	Press  button.	
2	Repeat pressing  button until  icon flash.	
3	Press   button to change converting temp value : 1~7	 
4	Press  button to complete and active the setting process.	
5	Press  button to exit or system will automatically release without any input after 25 seconds.	

Installer Setting-Celsius / Fahrenheit Switching

1. Wired Remote Controller

This function is used for switching the display between Celsius and Fahrenheit.
(Optimized only for U.S.A)

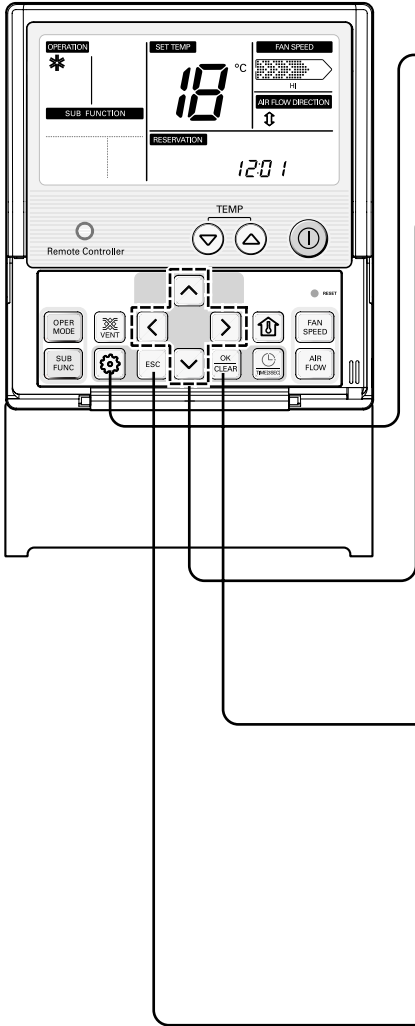

- 1** Press button for 4 seconds to enter the installer setting mode until timer segment display "01:01".



- 2** Repeat pressing button to select Function code 12.



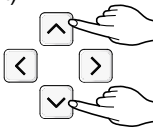

Function Code conversion mode value

Ex) Fahrengit Setting
- 3** Select Temperature unit mode by pressing button.
(00: Celsius, 01: Fahrenheit)

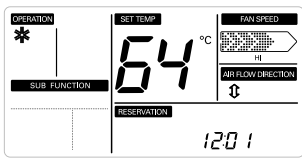

- 4** Press button to save or release.



- 5** Press button to exit or system will automatically exit after 25 seconds without any input.



* Whenever press button in Fahrenheit mode, the temperature will increase/drop 2 degrees.

2. Wireless Remote Controller

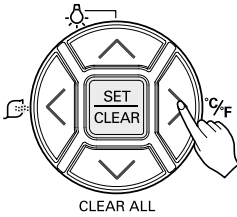
Press the °C/°F SWITCH button to change from Celsius to Fahrenheit or from Fahrenheit to Celsius.





Whenever press TEMPERATURE SETTING button in Fahrenheit mode, the temperature will increase/drop 2°F.

Function setting : Filter Sign Clear

This function is to clear the indicator of indoor filter cleaning.

1 Press  button.

Repeat pressing  button until the  icon flash.

















2 When the flashing, press the button to  clear this display.

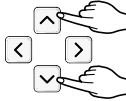

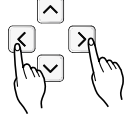
When filter is covered by dust, it will reduce cooling/ heating efficiency and accumulate more electric power. Therefore, do clean the filter whenever cleaning time is expired.

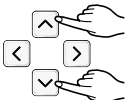













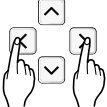

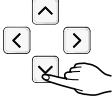

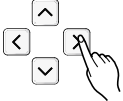

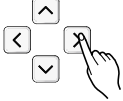
Function setting : Vane Angle Control

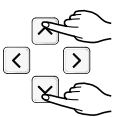
This function is to adjust angle at which airflow is blow out.

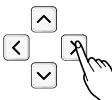
<p>1 Press  button.</p>	
<p>2 Repeat pressing  button until  icon flash.</p> <p>Ex) Setting second Vane Angle as 'P3'</p>	
<p>3 Press   button to select active vane: 1/2/3/4/All 1-4: control individually each vane All: control all vane with the same duration.</p>	
<p>4 Press   button to select Vane number/ Vane angle.</p> <p>Vane angle : 6 Step(P1~P6) & Sd Sd : Standard angle</p>	
<p>5 Press   button to adjust the angle value.</p>	
<p>6 Press  button to complete and active the setting process. (Airflow direction function will be released whenever setting vane angle)</p>	
<p>7 Press  button to exit or system will automatically release without any input after 25 seconds.</p>	

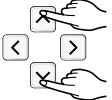
Setting Current Time

1. Wired Remote Controller

<p>1 Keep pressing  button for 4 secs to enter Setting current time mode.</p>	
<p>2 Press   key to adjust the current day.</p>	
<p>3 Press  key to move to AM/ PM setting mode (the 'AM/ PM' segment will flash).</p>	
<p>4 Setting AM/ PM value by pressing  button.</p>	
<p>5 Press  button to move to 'Hour' setting mode. (the 'Hour' segment will flash)</p>	
<p>6 Setting Hour value by pressing   button.</p>	
<p>7 Press  button to move to 'Minute' setting mode. (the 'Minute' segment will flash)</p>	
<p>8 Setting Minute value by pressing   button.</p>	
<p>9 Press  button to finish.</p>	
<p>10 In the process, press  button to release and exit from setting mode. (In case of exit with incomplete information, it will return to the previous setting</p>	

2. Wireless Remote Controller

1. Press the TIMER button for 3 seconds.



3. Press the SET / CLEAR button.



2. Press TIME SETTING buttons until the desired time is set.







NOTE

Check the indicator for A.M. and P.M.

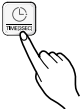
Programming : Setting Simple Reservation(Wired Remote Controller)

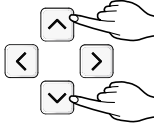







In case of there is not any reservation setup on system, it is possible to make a SIMPLE reservation on indoor unit.

<p>1 Press  button to enter the Programming mode. (the SIMPLE segment flashing)</p>	
<p>2 Press   button to adjust reservation time.</p>	
<p>3 Press  button to finish setting.</p>	
<p>4 Adjusting the reservation time after finish reservation setting will release the previous one.</p>	

* If the indoor is ON, we can make the reservation for turning OFF. In reserve, if the indoor is OFF, we can set the timer for turning ON. The reservation time is from 1 to 7 hours.

Programming : Weekly Reservation(Wired Remote Controller)

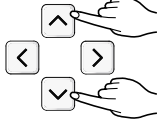
The weekly reservation is active after setting current time



<p>1 Press  button to enter the reservation setting mode.</p>	
<p>2 Repeat pressing  button to enter the weekly reservation setting mode. ( segment flashing)</p>	
<p>3 Set the ON/ OFF reservation for day in week</p> <ul style="list-style-type: none"> - Press   to adjust timing and Left/ Right to shift to next setting mode. - A day is considered as non-reservation if there is not any time reservation within. 	
<p>4 Press  button to finish setting.</p>	



Programming : Setting Sleep Reservation(Wired Remote Controller)

This function is able to turn off Air conditioner when sleeping or after some hours.



1 Press  button to enter the Programming mode.

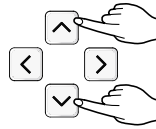

2 Repeat pressing  button to enter the SLEEP reservation setting mode.
( segment flashing)

3 Press   button to adjust reservation time.
The SLEEP reservation time is from 1 to 7 hours.



4 Press  button to finish setting.
Whenever reservation is done,  icon will flash.
When this setting is released,  icon will disappear.



5 Adjust the reservation time after finish reservation setting will release the previous one.

CAUTION



Please set a suitable time for sleep reservation.
(turning cooling for long time may be harmful to health)

Programming : Setting ON Reservation(Wired Remote Controller)



This function is able to turn air conditioner ON after a setting time.

1 Press  button.





2 Repeat pressing  button to enter the ON reservation setting mode.
( segment flashing)



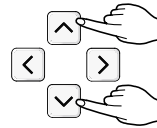

3 Press   button to adjust AM/ PM setting.



4 Press   button to Hour setting mode. When the Hour icon flash, please setting time.
The setting range is within 1~12.



5 Press   button to shift to Minute setting mode. When the Minute icon flash, please setting minute the setting range is within 00~59.















6 Press  button to finish setting.

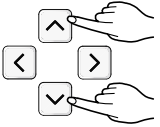

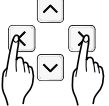

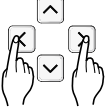







Programming : Setting OFF Reservation(Wired Remote Controller)

This function is able to turn air conditioner OFF after a setting time.

<p>1 Press  button.</p>	
<p>2 Repeat pressing  button to enter the OFF reservation setting mode. ( segment flashing)</p>	
<p>3 Press   button to adjust AM/ PM setting.</p>	
<p>4 Press   button to shift to Hour setting mode. When the Hour icon flash, please setting time. The setting range is within 1~12.</p>	
<p>5 Press   button to shift to Minute setting mode. When the Minute icon flash, please setting minute the setting range is within 00~59.</p>	
<p>6 Press  button to finish setting.</p>	

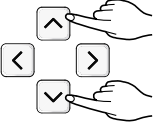
Programming : Holiday Reservation(Wired Remote Controller)

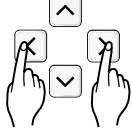
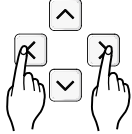
This function is to automatically stop the machine working on some days.

<p>1 Press  button to enter the reservation setting mode.</p>	
<p>2 Repeat pressing  button to enter the holiday reservation setting mode. (HOLIDAY segment flashing)</p>	
<p>3 Press   button to move to holiday position.</p>	
<p>4 Press   button to set or release a selected day as holiday or not. (* the holiday is indicated with a underline)</p>	
<p>5 If there is any holiday from Monday to Sunday, HOLIDAY segment on LCD will be displayed.</p>	
<p>6 Press the  button to exit or if there is not any input, system will release any setting after 10 seconds.</p>	
<p>7 It is possible to set the air conditioner OFF in every "holiday" (ex. 9:00, 10:00, 13:00)</p>	

Timer Setting(Wireless Remote Controller)

1. Press the TIMER button to turn timer on or off.



3. Press the SET / CLEAR button.



2. Press TIME SETTING buttons until the desired time is set.



NOTE Select one of the following 3 types of operation.



Timer Sleep



Timer On



Timer Off

To cancel the Timer Setting(Wireless Remote Controller)

• If you wish to cancel all timer setting, press the CLEAR ALL button.



• If you wish to cancel each timer setting, press the TIMER button to turn timer sleep or on or off as you want. And then press the SET/CLEAR button aiming the remote controller at the signal receptor.

(The timer lamp on the air conditioner and the display will go off.)



Ventilation Kit Control(Optional)

If there is a linkage between ventilator and air conditioner, it is able to control this ventilator.

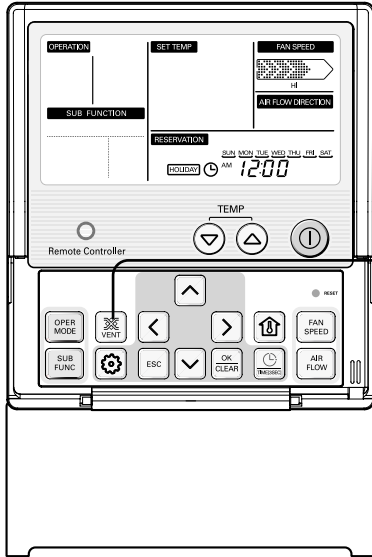

1 Press Ventilation button to turn ON/ OFF the ventilator.

2 In case of operating the ventilator, the 'Ventilation' icon will be displayed.

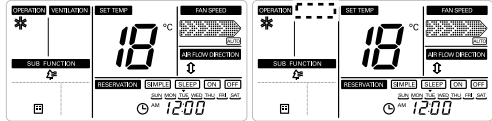

Operating ventilation

Stop ventilation

3 When turn off ventilator, the 'Ventilation' icon disappears.

4 Please refer the Ventilation instruction in function setting menu in order to connect a ventilator to air conditioner.

In case of not-connected ventilator, this ventilation function can not be operated.

Forced operation

Operation procedures when the remote control can't be used.
 The operation will be started if the ON/OFF button is pressed.
 If you want to stop operation, re-press the button.

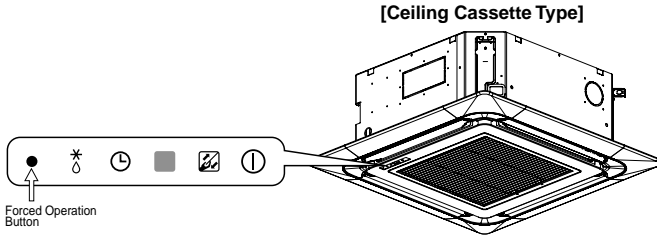

	Room Temp. $\geq 24^{\circ}\text{C}(75.2^{\circ}\text{F})$	$21^{\circ}\text{C}(69.8^{\circ}\text{F}) \leq \text{Room Temp.} < 24^{\circ}\text{C}(75.2^{\circ}\text{F})$	Room Temp. $< 21^{\circ}\text{C}(69.8^{\circ}\text{F})$
Operating mode	Cooling	Healthy Dehumidification	Heating
Indoor FAN Speed	High	High	High
Setting Temperature	$22^{\circ}\text{C}(72^{\circ}\text{F})$	$23^{\circ}\text{C}(74^{\circ}\text{F})$	$24^{\circ}\text{C}(76^{\circ}\text{F})$

Test operation

During the TEST OPERATION, the unit operates in cooling mode at high speed fan, regardless of room temperature and resets in 18 minutes.

During test operation, if remote controller signal is received, the unit operates as remote controller sets.

If you want to use this operation, Press and hold the ON/OFF button for 3~5 seconds, then the buzzer sound 1 "beep".

If you want to stop the operation, re-press the button.

Maintenance and Service

Indoor Unit

Grille, Case and Remote Control

□ Turn the system off before cleaning. To clean, wipe with a soft, dry cloth. Do not use bleach or abrasives.

NOTE

Supply power must be disconnected before cleaning the indoor unit.

Air Filters

The air filters behind the front grille should be checked and cleaned once every 2 weeks or more often if necessary.



■ Never use any of the followings:

- Water hotter than 40°C.
Could cause deformation and/or discoloration.
- Volatile substances.
Could damage the surfaces of the air conditioner.



1 Remove the Air filters.

- Take hold of the tab and pull slightly forward to remove the filter.



CAUTION: When the air filter is to be removed, do not touch the metal parts of the indoor unit. It may cause an injury.

2 Clean dirt from the air filter using a vacuum cleaner or washing with water.

- If dirt is conspicuous, wash with a neutral detergent in lukewarm water.
- If hot water (50°C or more) is used, it may be deformed.

3 After washing with water, dry well in the shade.

- Do not expose the air filter to direct sunlight or heat from a fire when drying it.

4 Install the air filter.

Purifying filter(Optional)

Cleaning

The PLASMA filter behind the air filters should be checked and cleaned once every 3 months or more often if necessary.

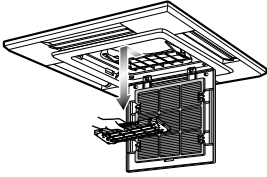

- 1 After removing the air filters, pull slightly forward to remove the PLASMA filter.
- 2 Dip the PLASMA filter into the water mixed with neutral detergent, for 20~30 minutes.
- 3 Dry the PLASMA filter in the shade for a day (Especially, the humidity must be removed perfectly on this parts).
- 4 Note the cuts of electric discharge lines.
- 5 Re-install the PLASMA filter to the original position.



CAUTION: Don't touch this PLASMA Filter within 10 seconds after opening the inlet grille, it may cause an electric shock.

Replacement

• Recommended use period : About 2 years

- 1 Open front panel and remove air filter.

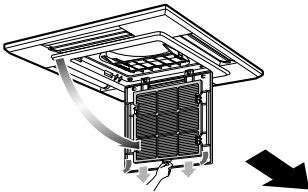

- 2 Remove air purifying filter.
- 3 Insert new air purifying filter.

- 4 Reinsert air filter and close front panel.

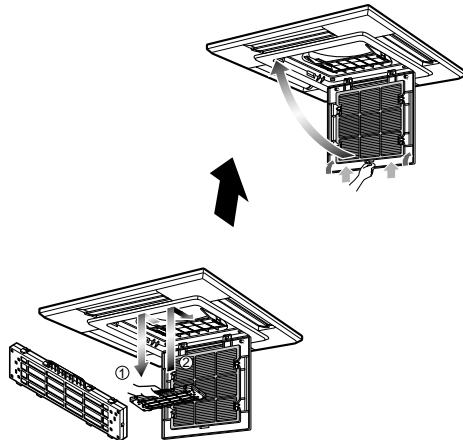

Operation Tips!

Do not overcool the room.

This is not good for the health and wastes electricity.

Keep blinds or curtains closed.

Do not let direct sunshine enter the room when the air conditioner is in operation.

Keep the room temperature uniform.

Adjust the vertical and horizontal airflow direction to ensure a uniform temperature in the room.

Make sure that the doors and windows are shut tight.

Avoid opening doors and windows as much as possible to keep the cool air in the room.

Clean the air filter regularly.

Blockages in the air filter reduce the airflow and lower cooling and dehumidifying effects. Clean at least once every two weeks.

Ventilate the room occasionally.

Since windows are kept closed, it is a good idea to open them and ventilate the room now and then.

When the air conditioner is not going...

When air conditioner is not going to be used for a long time.

- 1 Operate the air conditioner at the following settings for 2 to 3 hours.
 - Type of operation: Fan operation mode.(Refer to page 11.)
 - This will dry out the internal mechanisms.
- 2 Turn off the breaker.



CAUTION: Turn off the breaker when the air conditioner is not going to be used for a long time.
Dirt may collect and may cause a fire.

3. Remove the batteries from the Remote Controller.

Helpful information

The air filters and your electric bill.

If the air filters become clogged with dust, the cooling capacity will drop, and 6% of the electricity used to operate the air conditioner will be wasted.

When the air conditioner is to be used again.

1. Clean the air filter and install it in the indoor unit.
(Refer to page 33 for cleaning it.)
2. Check that the air inlet and outlet of the indoor/outdoor unit are not blocked.
3. Check that the ground wire is connected correctly. It may be connect to the indoor unit side.

Troubleshooting Tips! Save time and money!

Check the following points before requesting repairs or service.... If the malfunction persists, please contact your dealer.

Case	Explanation
The air conditioner does not operate.	<ul style="list-style-type: none"> • Have you made a mistake in timer operation? • Has the fuse blown or has the circuit breaker been tripped?
The room has a peculiar odor.	<ul style="list-style-type: none"> • Check that this is not a damp smell exuded by the walls, carpet, furniture or cloth items in the room.
It seems that condensation is leaking from the air conditioner.	<ul style="list-style-type: none"> • Condensation occurs when the airflow from the air conditioner cools the warm room air.
Air conditioner does not operate for about 3 minutes when restart.	<ul style="list-style-type: none"> • This is the protector of the mechanism. • Wait about three minutes and operation will begin.
Does not cool or heat effectively.	<ul style="list-style-type: none"> • Is the air filter dirty? See air filter cleaning instructions. • The room may have been very hot when the room air conditioner was first turned on. Allow time for it to cool down. • Has the setting temperature been set incorrectly? • Are the indoor unit's air inlet or outlet vents obstructed?
The air conditioner operation is noisy.	<ul style="list-style-type: none"> • For a noise that sounds like water flowing. -This is the sound of freon flowing inside the air conditioner unit. • For a noise that sounds like the compressed air releasing into atmosphere. -This is the sound of the dehumidifying water being processed inside the air conditioning unit.
Crack sound is heard.	<ul style="list-style-type: none"> • This sound is generated by the expansion/contraction of the inlet grille, etc. due to changes of temperature.
Filter sign lamp (LED) is ON.	<ul style="list-style-type: none"> • Cleaning the filter, press the Timer button and ◀ button of wired remote controller at the same time for 3 sec.
Remote control display is faint, or no display at all.	<ul style="list-style-type: none"> • Has the circuit breaker been tripped? • Are the batteries inserted in the opposite (+) and (-) directions?

Call the service immediately in the following situations

1. Anything abnormal such as burning smell, loud noise etc. happen. Stop the unit and turn the breaker off.
Never try to repair by yourself or restart the system in such cases.
2. Main power cord is too hot or damaged.
3. Error code is generated by self diagnosis.
4. Water leaks from indoor unit even if the humidity is low.
5. Any switch, breaker (safety, earth) or fuse fails to work properly

**User must carry routine checkup & cleaning to avoid unit's poor performance.
In case of special situation, the job must be carried out by service person only.**



US	1. Please call the installing contractor of your product, as warranty service will be provided by them. 2. If you have service issues that have not been addressed by the contractor, please call 1-888-865-3026.
CANADA	Service call Number # : (888) LG Canada, (888) 542-2623