

This Owner's Manual is provided and hosted by [Appliance Factory Parts](#).

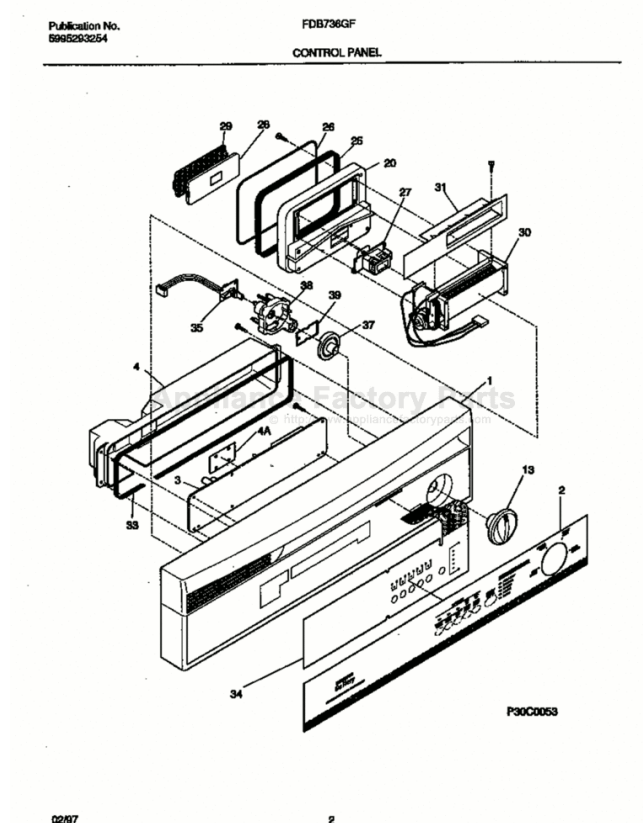

# FRIGIDAIRE FDB736GFR2 Owner's Manual

[Shop genuine replacement parts for FRIGIDAIRE  
FDB736GFR2](#)



[Find Your FRIGIDAIRE Dishwasher Parts - Select From 369 Models](#)

----- Manual continues below -----

# Dishwasher

## Installation Instructions

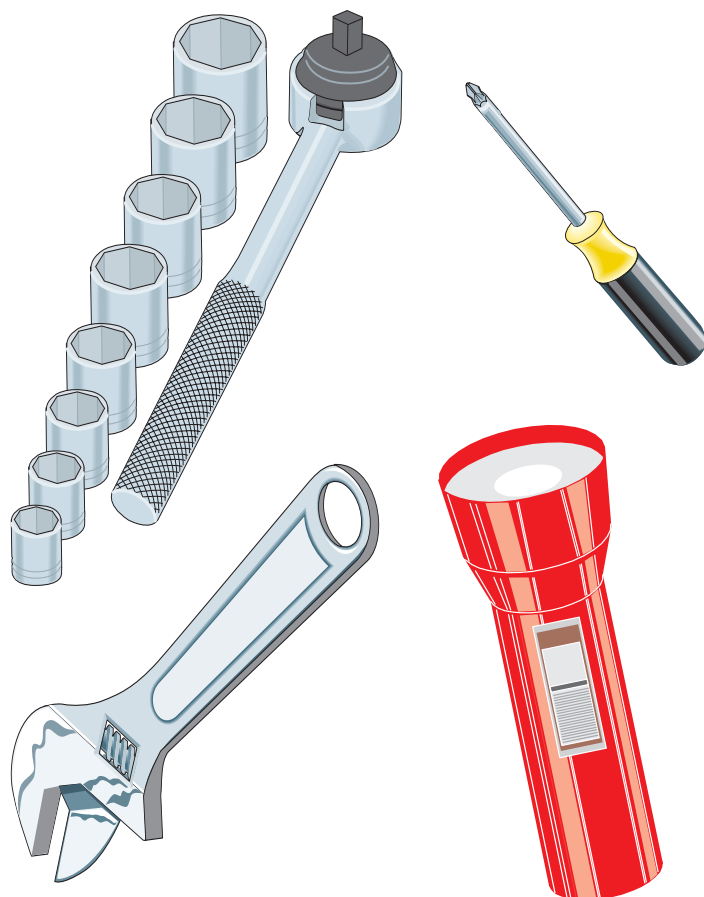

**INSTALLER:** Leave *Installation Instructions* with owner.

**OWNER:** Read your dishwasher *Use and Care Manual*. It contains important safety information for operating this appliance. It also has many suggestions for getting the best results from your dishwasher.

154256102  
(5/97)

### Before You Begin

Read all instructions before installing dishwasher.

For your safety, please read and observe all safety instructions.

This guide will help you anticipate drain, water, and electrical connections, and help you select the best location for the dishwasher.

### Parts You Will Need\* (Not Included)

- Drain Hose Clamp, 1 1/4" Diameter
- Elbow, 90° with a 3/8" National Pipe Thread
- Strain Relief Bushing
- Wire Nuts, two (2) for 12-14 gauge wire

#### \* If required:

- "Y" Branch Tailpiece and Connector Kit (See Step 4)
- Air Gap Kit (See Step 4)
- Fasteners for floor anchoring (See Step 10)

#### Available at:

Plumbing

Plumbing

Hardware

### ! WARNING



#### Electric Shock Hazard

Disconnect electrical power at the breaker box before beginning installation. Failure to follow this warning could result in injury.

- Examine dishwasher and locate connection points.
- Locate dishwasher where there is easy access to water and electrical lines. The best location is on the kitchen sink for access to existing plumbing and loading dishes. See Step 4.
- Electrical, water, and drain connections are common to all age, brands, or models of dishwashers. Consider the age and length of home utilities. See Step 4.
- A 15-20 amp, grounded, 120 volt AC only, electrical circuit is required. See Steps 4 and 9.
- If dishwasher drain hose will be connected to an existing drain for the first time, knock out plug located inside the drain. See Steps 4 and 6.
- Kinked water or drain hoses can cause problems. Do not remove drain hose from tub attachment. See Step 4.
- Dishwashers need to be connected to a hot water line with enough water pressure to insure an adequate flow. See Steps 4 and 8.
- Each home installation differs. You will need the parts listed above to complete your installation. See Step 4.
- Flush water line prior to making the final connection to prevent clogging of dishwasher's filter screen. See Step 4.
- The dishwasher will look, sound, and perform better if properly leveled. See Step 7. (NOTE: If leveling is required during installation, make sure the floor is flat and free of obstruction.)
- Anchor the dishwasher to countertop. See Step 10.

### Installation Preparation

1. Remove two (2) screws at front of the kickplate using a #2 Phillips screw driver.
2. Pull forward to remove. (Figure 1) Models with...

### ! WARNING

Tip Over Hazard