

This Owner's Manual is provided and hosted by [Appliance Factory Parts](#).

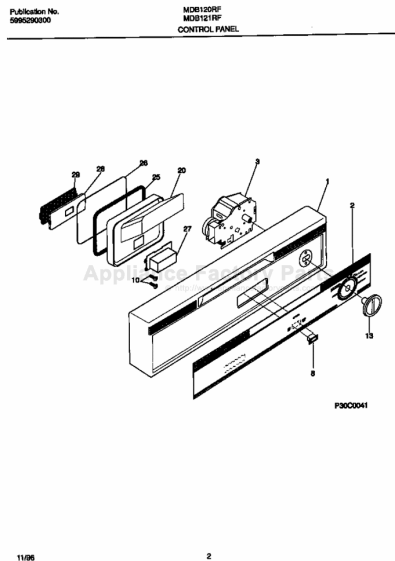

Electrolux MDB121RFS1 Owner's Manual

[Shop genuine replacement parts for Electrolux
MDB121RFS1](#)



[Find Your Electrolux Dishwasher Parts - Select From 406 Models](#)

----- Manual continues below -----

Dishwasher

Use & Care Manual

100 Series



**Record All Information
For Future Reference**

Brand: _____ Purchase Date: _____

Model #: _____

Serial #: _____
(see Features page for location)

Questions? 1-800-944-9044

(United States)

1-800-661-9913

(Canada)

Visit Frigidaire Company's
Web Site at
<http://www.frigidaire.com>

Product Registration Card

Please fill in completely, sign and return promptly!

Safety

Instructions 2

Features 3

Normal Operating
Sounds 4

Operating
Instructions 4-5

Preparing and
Loading Dishes 6-7

Dishwasher Dispenser
and Detergents 8-9

Factors Affecting
Performance 9

Care and
Cleaning 10-11

Changing
Color Panels 12-13

Solutions to Common
Dishwashing Problems . 14-16

Consumer Services

Warranty & Service 17-18

Versión en español 17

READ AND SAVE THESE INSTRUCTIONS

P/N 154256202 (9702)



Important Safety Instructions

! WARNING

This symbol will help alert you to such dangers as personal injury, burns, fire and electrical shock.

! WARNING

To reduce the risk of fire, electrical shock, or injury when using your dishwasher, follow basic precautions including the following:

- Read all instructions before using your dishwasher.
- Use your dishwasher only as instructed in this Use and Care Manual.
- This Manual does not cover every possible condition or situation that may occur. Use common sense and caution when installing, operating and maintaining any appliance.
- **DISHWASHER MUST BE ELECTRICALLY GROUNDED.** Read the Installation Instructions for details.
- This dishwasher is designed to operate on regular house current (120 V, 60 Hz). Use a circuit equipped with a 15 ampere fuse or circuit breaker. Use a 20 ampere fuse if dishwasher is connected with a food waste disposer.
- Do not operate dishwasher unless all enclosure panels are in their proper place.
- Dispose of discarded appliance and shipping or packing material properly.
- To avoid entrapment and/or suffocation, remove door or door latch mechanism from any dishwasher that is discarded or not in use.
- Keep young children and infants away from dishwasher when it is operating.
- Do not let children abuse, sit, stand or play on door or racks of a dishwasher.
- Use only detergents and rinse agents recommended for use in a dishwasher.
- Store dishwasher detergent and rinse agents out of the reach of children.
- Do not wash plastic items unless marked "dishwasher safe" or the equivalent. Check with manufacturer for recommendations, if not marked. Items that are not dishwasher safe may melt and create a potential fire hazard.
- If the dishwasher drains into a food disposer, make sure disposer is completely empty before running dishwasher.
- Disconnect electrical power to dishwasher before servicing.
- Repairs should be done by a qualified technician.
- Do not tamper with controls.
- Do not touch the heating element during or immediately after use.
- Load sharp knives with the handles up to reduce the risk of cut-type injuries.
- Under certain conditions, hydrogen gas may be produced in a hot water system that has not been used for 2 weeks or more. **HYDROGEN GAS IS EXPLOSIVE.** If hot water system has not been used for such a period, before using dishwasher, turn on all hot water faucets and let water flow from each for several minutes. This will release any accumulated hydrogen gas. **HYDROGEN GAS IS FLAMMABLE.** Do not smoke or use an open flame during this time.
- Do not store or use combustible materials, gasoline or other flammable vapors and liquids in the vicinity of this or any other appliance.

**SAVE THESE
INSTRUCTIONS**



Dishwasher Features

Your dishwasher cleans by spraying a mixture of hot water and detergent through the spray arms against soiled surfaces. Each cycle begins with a pre-drain. Next, the dishwasher fills with water covering the filter area. Water is then pumped through the filter and spray arms. Soil particles go down the drain as the water is pumped out and replaced with clean water. The number of water fills will vary with the cycle being used.

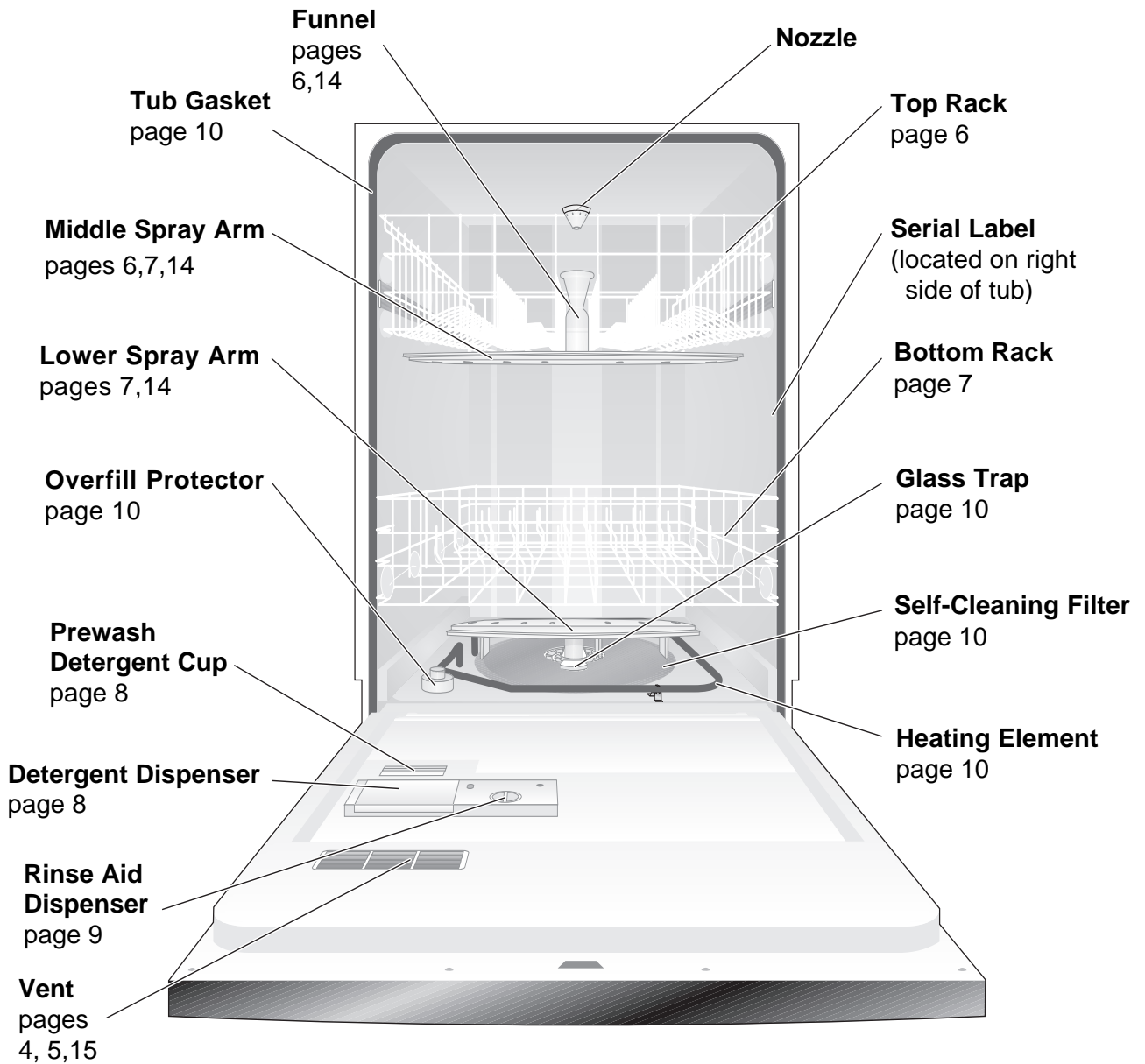



Operating Instructions

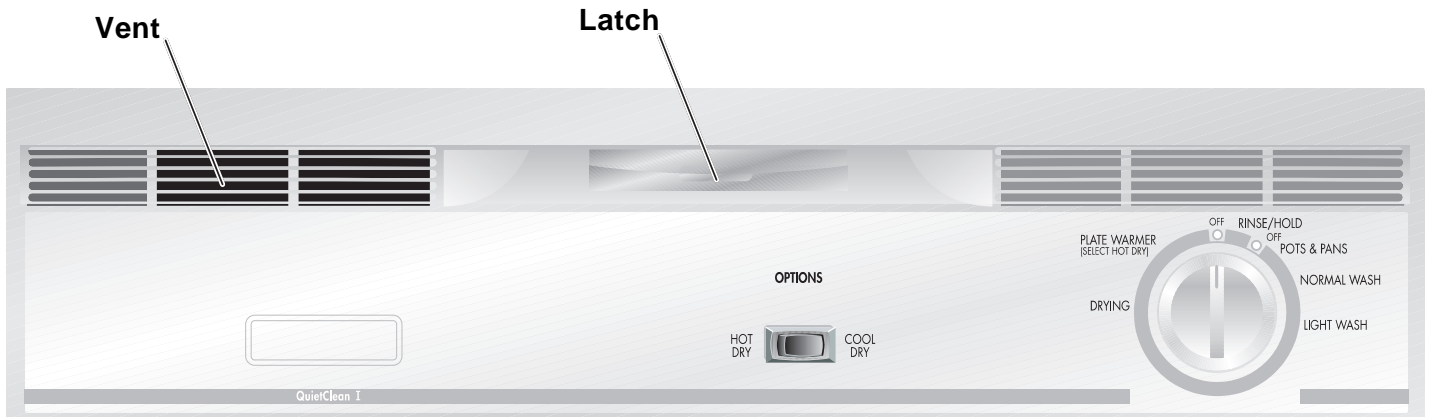

Model MDB121

Very Important Information— Read Before Operating Your Dishwasher!



Normal Operating Sounds

This dishwasher does not sound like most dishwashers—IT'S QUIETER!

The new wash system uses energy efficient motors for the wash and drain portions of the cycle you select. Each cycle has a series of water fills and drains for washing and rinsing dishes. As each cycle begins, you may—or may not—hear the drain motor.

The next sound you will hear is the splashing water as it enters the tub. Then the lower arm rotates and circulates water. This is followed by a pause and a slightly different sound as the upper arm sprays water. If you listen closely, you will hear the change in sound as the wash action switches from one arm to the other.

PLEASE BE ADVISED: If you compare this dishwasher to previous models, you may be surprised at what you DON'T hear!

Getting Started

1. Load dishwasher (See Preparing and Loading Dishes).
2. Add detergent (See Dishwasher Dispenser & Detergents).
3. Add rinse aid, if needed (See Rinse Aid).
4. Turn dial clockwise to select cycle (See Wash Cycle Selections).
5. Select desired energy OPTIONS (See Energy Options).
6. Run hot water faucet nearest dishwasher until water is hot. Turn water off.
7. To start, close door to latch.



Operating Instructions (continued)

Wash Cycle Selections

Note: Cycle times are approximate and not all cycles available on all models.

Pots & Pans

(89 minutes) (2 washes, 4 rinses, dry)
(7.2 gallons) (6.0 imp. gallons) (27.3 liters)
For pots, pans, casseroles and dinnerware with dried-on or baked-on soils:

- Turn dial to POTS & PANS.
- Select desired OPTIONS.

Heavy Wash

(89 minutes) (2 washes, 4 rinses, dry)
(7.2 gallons) (6.0 imp. gallons) (27.3 liters)
For heavily soiled dishes and silverware:

- Turn dial to HEAVY WASH.
- Select desired OPTIONS.

Normal Wash

(81 minutes) (2 washes, 3 rinses, dry)
(6.0 gallons) (5.0 imp. gallons) (22.7 liters)
For regularly soiled dishes and silverware:

- Turn dial to NORMAL WASH.
- Select desired OPTIONS.

Light Wash

(74 minutes) (1 wash, 3 rinses, dry)
(4.8 gallons) (4.0 imp. gallons) (18.2 liters)
For lightly soiled or pre-rinsed dishes and silverware:

- Turn dial to LIGHT WASH.
- Select desired OPTIONS.

Rinse/Hold

(8 minutes) (1 rinse)
(1.2 gallons) (1.0 imp. gallons) (4.5 liters)
For rinsing dishes that will be washed later:

- DO NOT USE detergent.
- Turn dial to RINSE/HOLD.

Plate Warmer

(14 minutes) (dry) (0 gallons)
For warming dishes and serving plates before serving hot foods.

- Load clean plates and dishes to be warmed.
- Turn dial to PLATE WARMER.
- Select HOT DRY option.

Energy Options

Hot Dry Option

HOT DRY option provides faster drying since the heating element is on during the drying portion of the cycle.

Cool Dry Option

COOL DRY option saves electricity since the heating element is off during the drying portion of the cycle. To speed drying process, open the door slightly after the cycle is complete. Some water droplets may remain on door and tub and in areas where dishes touch silverware basket and rack.

With either option, you may see water vapor coming from vent during drying portion of cycle. The vent is closed during washing to hold moisture and sound inside and then opens for drying.

The drying option may be changed at any time during the cycle and affects only the drying period.



Preparing and Loading Dishes

Dish Preparation

Scrape away large pieces of food, bones, pits, toothpicks, etc. The continuous filtered wash system will remove remaining food particles. Burned-on foods should be loosened before loading. Empty liquids from glasses and cups.

Foods such as mustard, mayonnaise, vinegar, lemon juice and tomato based products may cause discoloration of stainless steel and plastics if allowed to sit for a long period of time. Unless the dishwasher is to be operated at once, it is best to rinse off these food soils.

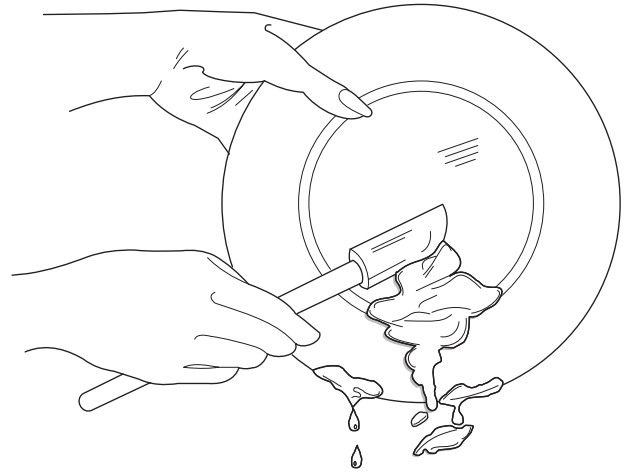

- Load racks so that large items do not prevent the detergent dispenser from opening.
- Check manufacturer's recommendations before washing items in question.
- If the dishwasher drains into a food disposer, **be sure disposer is completely empty before starting dishwasher.**

Loading the Top Rack

Important: Do not cover the funnel when loading.

The top rack is designed for cups, glasses, small plates, saucers and bowls.

Load glasses in top rack. Damage may occur if placed in bottom rack.

Load plastic items in top rack only. Melting may occur if placed in bottom rack.

Load items with open ends facing down for better cleaning and draining.

Damage may occur if delicate items touch each other during dishwasher operation.

Long-handled knives and utensils can be placed in top rack.

Be sure nothing protrudes through the bottom of the rack to block rotation of middle spray arm.

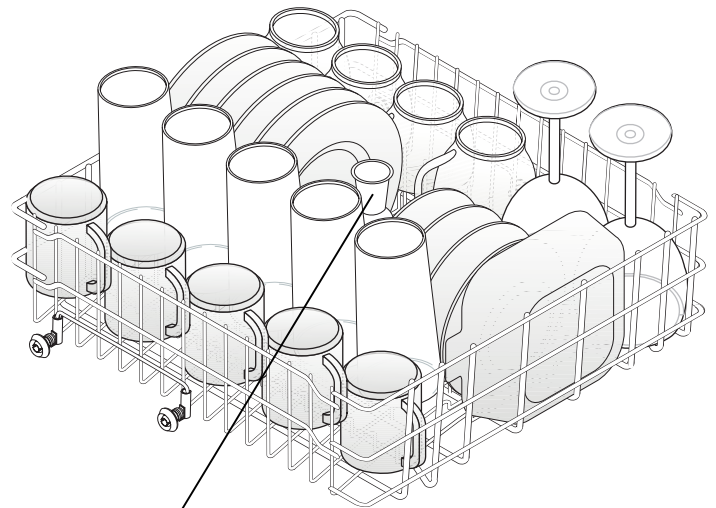

Do not cover funnel



Preparing and Loading Dishes (continued)

Loading the Bottom Rack

Make sure tall items do not block spray arm rotation.

Place plates and platters so that they do not touch.

Place bowls, casseroles and sauce pans with the soiled surface facing down or toward the center. Tilt slightly for better drainage.

Be sure pan handles do not protrude through the bottom of the rack and block the spray arm rotation.

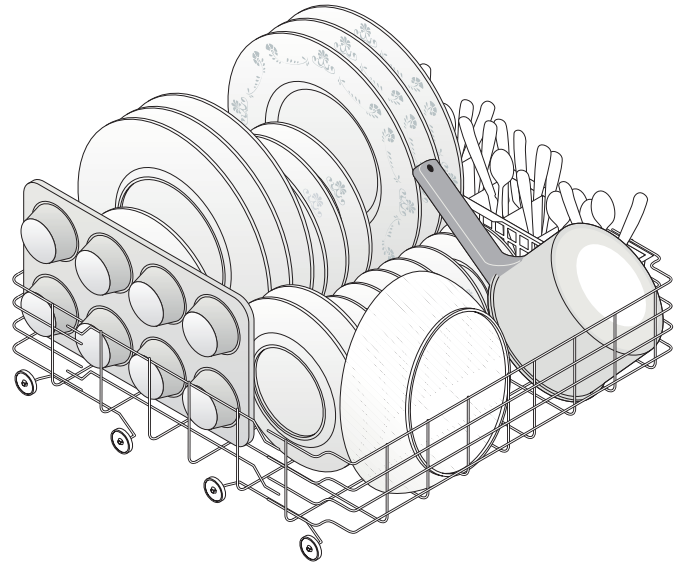

Loading the Silverware Basket

Mix spoons, forks and knives to prevent nesting. Mixing items gives better cleaning and drying.

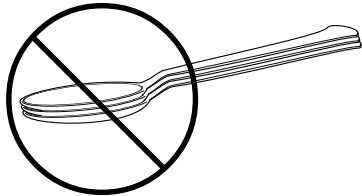

For safety, load sharp knives and forks with handles up.

Be sure nothing protrudes through bottom of basket or rack to block the spray arm.

Do not mix silver and stainless to avoid damaging the silver finish.

Note: Silverware basket may vary by model.

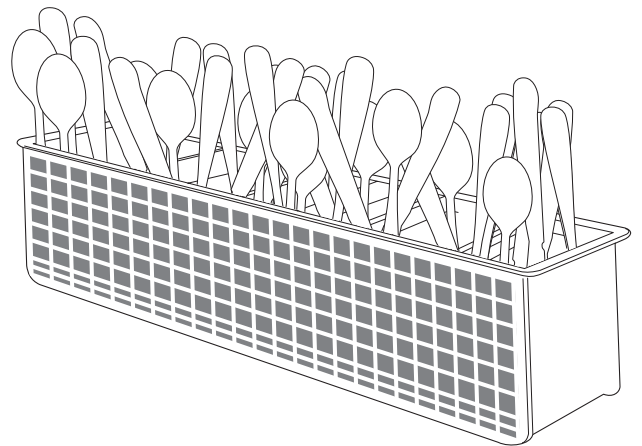

Adding a Dish

To add or remove items after wash cycle starts:

- Unlatch door and wait a few seconds until wash action stops before opening.
- Add the item and wait a few seconds to allow cold air to slowly expand inside dishwasher.
- Close door firmly to latch and resume cycle.



Dishwasher Dispenser & Detergents

- Use only fresh automatic dishwashing detergent. Other types will cause oversudsing.
- Add detergent just before starting cycle.
- Store detergent in a cool, dry location. Moist or caked detergent will not dissolve properly.

Filling the Detergent Dispenser

The detergent dispenser has one covered and one uncovered cup. Detergent in the uncovered cup falls into the dishwasher when the door is closed. The covered cup opens automatically in the main wash.

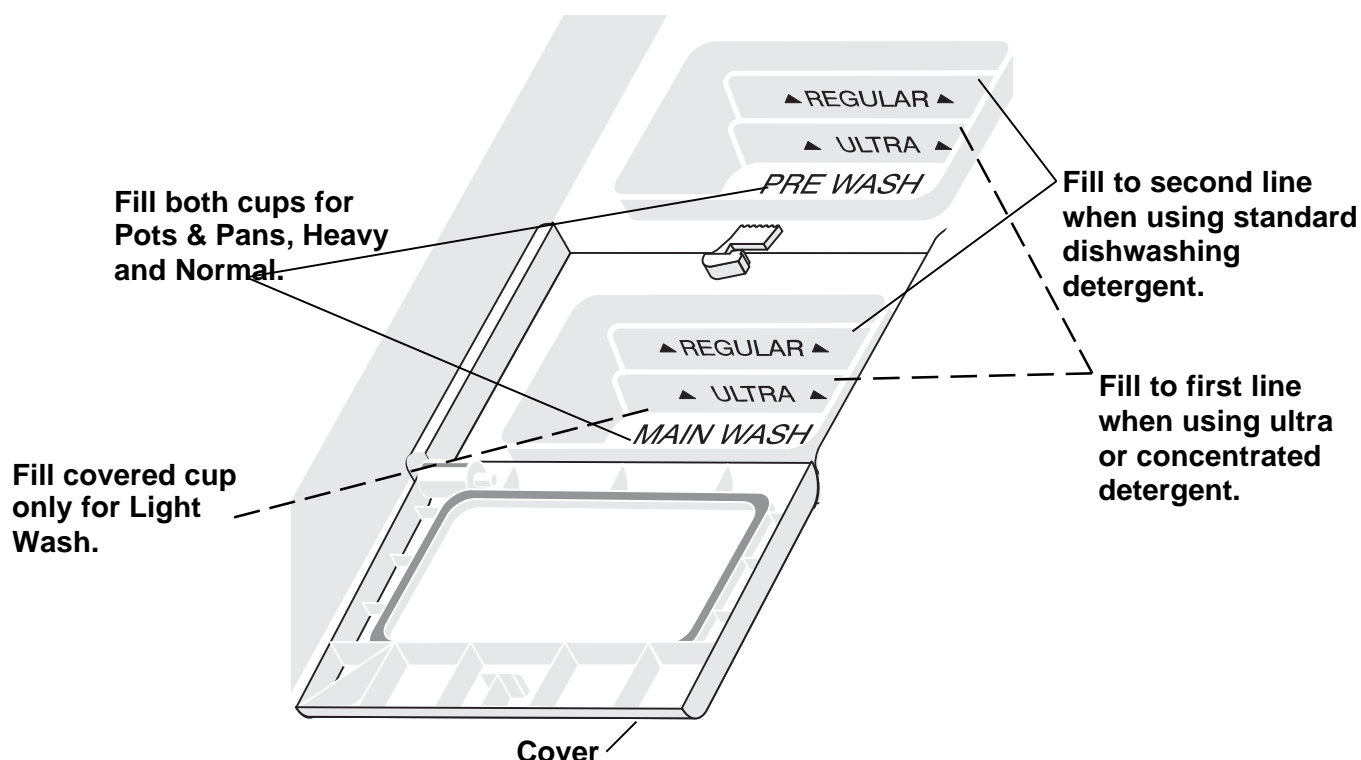

How much Detergent to use

The amount of detergent to use depends on the water hardness. Water hardness is measured in grains per gallon. Using too little detergent can result in poor cleaning and hard water filming or spotting. Using too much detergent in soft water can cause permanent etching on glassware. Your local water company, water softener company or county extension agent can tell you the water hardness in your area.

More detergent may be needed if the phosphorus content is 8.7% or less. The phosphorus content is shown on the detergent label.

Detergent Chart	
<u>Water Hardness</u>	<u>Amount per Cup</u>
Soft (0-3 grains)	2 Teaspoons
Medium (4-8 grains)	5 Teaspoons
Hard (9+ grains*)	10 Teaspoons (fill level with top)

* 12 grains and higher is extremely hard water. Detergent alone may not be enough. A water softener is recommended to improve water quality and dishwashing performance.



Dishwasher Dispenser & Detergents (continued)

Rinse Aid

Rinse aid greatly improves drying and reduces water spots and filming. Water "sheets" off dishes rather than forming water droplets that cling and leave spots.

A dispenser, located next to the detergent cup, automatically releases a measured amount of rinse aid during the last rinse. If spotting and poor drying are problems, increase the amount of rinse aid dispensed by rotating the dial to a higher number. The dial is located under the dispenser cap. The indicator will be dark when full and will show clear when it is time to refill.

To add liquid rinse aid, turn dispenser cap 1/4 turn counterclockwise and lift out. Pour in rinse aid until liquid touches the indicated fill level. Replace cap.

Do not overfill since this can cause oversudsing. Wipe up any spills with a damp cloth.

The dispenser holds enough for 35 to 140 washes, depending on setting.

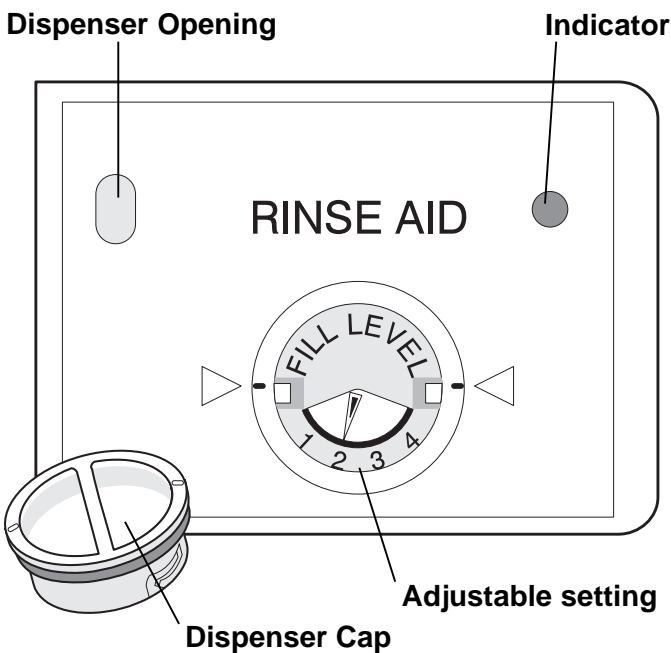

Factors Affecting Performance

Water Pressure

The hot water line to dishwasher must provide water pressure between 20 and 120 psi. Low water pressure may occur when laundry or showers are in operation. Wait until water use is reduced before starting dishwasher.

Water Temperature

Hot water is needed for best dishwashing and drying results. Water entering dishwasher should be at least 120°F (49°C) to give satisfactory results.

To check water temperature entering dishwasher:

- Turn on hot water faucet nearest dishwasher for several minutes to clear cool water from pipes.
- Hold a candy or meat thermometer in stream of water to check the temperature.
- If temperature is below 120°F (49°C), have a qualified person raise the thermostat setting.

Important: Before starting a cycle, run hot water to clear cool water from pipe.



Care and Cleaning

⚠ WARNING



Burn Hazard

Allow heating element to cool before cleaning the interior. Failure to do so can result in burns.

Outside—Occasionally wipe with a mild nonabrasive detergent and water. Rinse and dry.

Inside—The inside of the dishwasher is self-cleaning with normal use. If needed, clean around the tub gasket area with a damp cloth.

The filter is self-cleaning. A glass trap located in the center of the filter is designed to collect pieces of broken glass, straws, bones and pits. To remove items in glass trap, grasp handle, lift out, empty and replace.

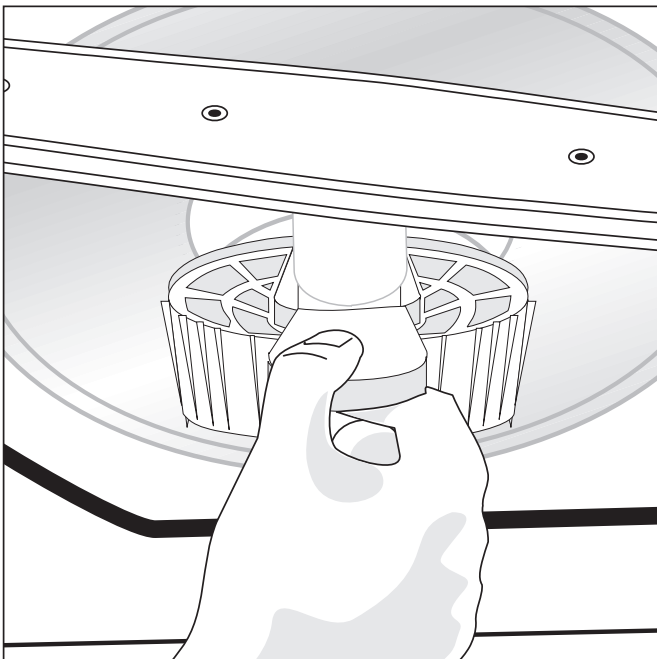

Note: Hard water may cause lime deposit buildup on the interior of the dishwasher. For cleaning instructions see "Removing Spots and Film" section.

Overfill Protector—keeps dishwasher from overfilling and is located in the left front corner of the tub.

- Clean occasionally with household cleaner containing vinegar or bleach to dissolve any buildup.
- Overfill Protector should move up and down freely about one inch. If it does not move, lift and clean underneath.

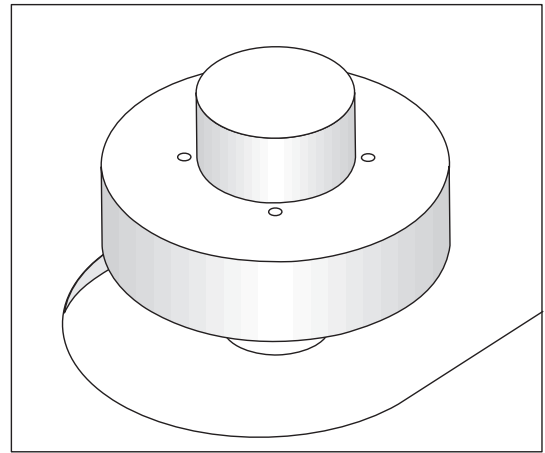

Care of Drain Air Gap

If a drain air gap was installed for your built-in dishwasher, check to make sure it is clean so the dishwasher will drain properly. A drain air gap is usually mounted on countertop and can be inspected by removing the cover. This is not part of your dishwasher and is not covered by warranty.



Care and Cleaning (continued)

⚠ CAUTION

Property Damage Hazard

Freezing temperatures may cause water lines to rupture. Be sure all supply lines to and circulating lines within dishwasher are protected.

Failure to do so could result in property damage.

Winterizing

A dishwasher left in an unheated place should be protected from freezing. Have a qualified person do the following:

To Disconnect Service:

1. Turn off electrical power to the dishwasher at the supply source by removing fuses or tripping circuit breaker.
2. Shut off water supply.
3. Place a pan under the inlet valve. Disconnect water line from inlet valve and drain into pan.
4. Disconnect drain line from pump and drain water into pan.

To Restore Service:

1. Reconnect the water, drain, and electrical power supply.
2. Turn on water and electrical power supply.
3. Fill both detergent dispensers and run dishwasher through a NORMAL cycle.
4. Check connections to make sure they do not leak.

Note: See Installation Instructions for more details.



Changing Color Panels

Some models come with reversible door panel inserts which offer three decorative colors. The panels are separated by a divider trim strip. Depending on the model, either or both panels may be changed.

To change the color panel:

Note: If your unit does not have a divider trim strip, exceptions to these directions are noted after the individual steps.

1. Remove snap-on bottom trim by pulling forward. Support door panels by pressing in gently while removing trim. **Note:** After trim is removed, check bottom edge of door for reference when replacing later.

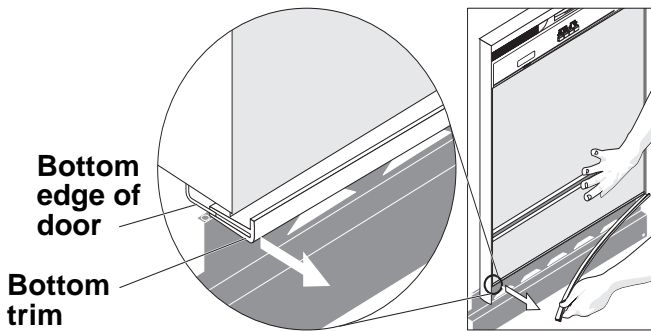

2. With one hand on the upper panel and one hand on the lower panel, gently slide the panel assembly down until the entire assembly rests on the floor. **Note:** Slide color panel(s) down about 1/2" on units without a divider trim strip.

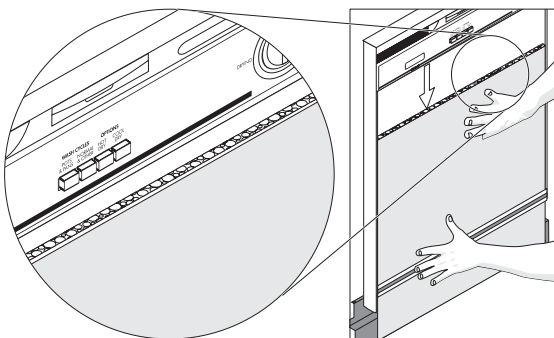

3. Grasp top of upper panel(s) and pull up until clear of divider trim strip. Then bow panel(s) until clear of side trim. Remove panel(s) but do not remove spacer. **Note:** To complete color panel change on units without a divider trim strip, proceed with steps 5, 6 and 8.

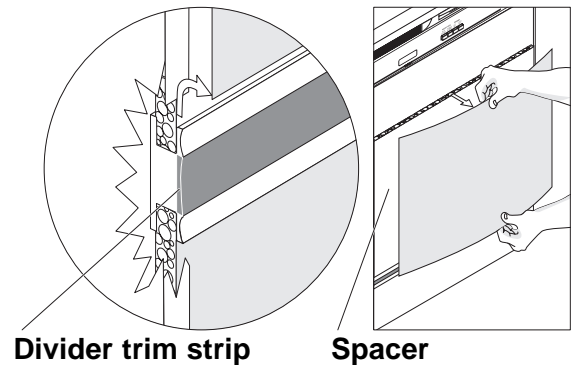

4. Check to see if spacer has remained in the channel of the divider trim strip. If it has not, replace securely in channel. It may be helpful to gently push in on divider trim strip while reinserting the spacer.

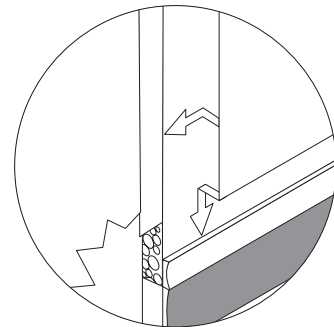

⚠ CAUTION	
	<p>Cut Hazard</p> <p>Metal door panels are sharp and should be handled with care. Wear gloves to protect hands.</p> <p>Failure to do so can result in injury.</p>



Changing Color Panels (continued)

5. Arrange panel(s) so the desired color is facing out. Place one side of panel(s) under side trim and bow slightly until other side fits under opposite trim. Push down to make sure panel(s) and spacer are in channel of divider trim strip.

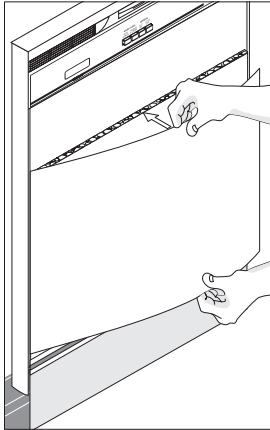

7. To change lower panel, use one hand to hold upper panel assembly and divider trim strip in place and use the other hand to slide lower panel down until it clears divider. Remove panel(s), arrange desired color and replace per above directions for upper panel. Do not remove foam spacer.

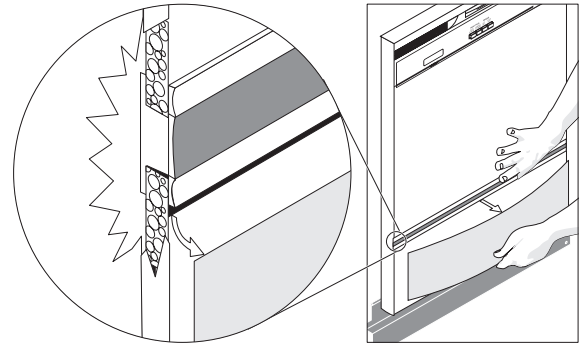

6. Move complete panel assembly up by pushing from sides and bottom of lower panel. Check to make sure the color panel(s) fit securely under control panel by pressing in at top of color panel(s).

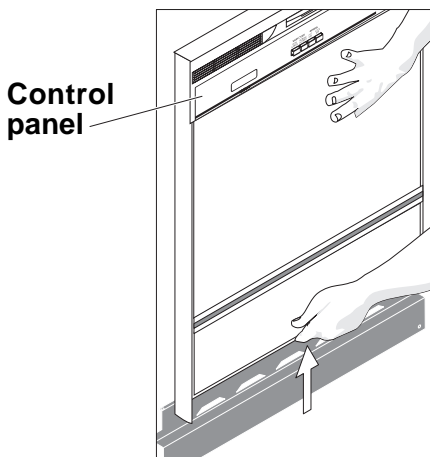

8. Replace bottom trim by fitting slot over bottom edge of door and secure by pressing from one side to the other. **Note:** If trim does not go on easily, check to make sure assembly is pushed all the way up under the control panel and spacers and panels are in channel of divider trim strip.

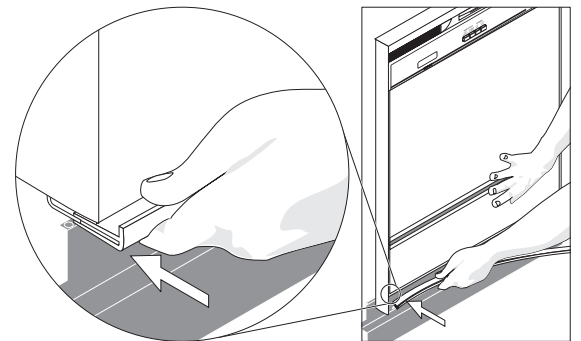

Customized Wood Panels

Your dishwasher can be customized with 1/4" wood panels. Refer to your Installation Instructions for more information.



Solutions to Common Dishwashing Problems

Before calling for service, review this list. It may save you both time and expense. This list includes common experiences that are not the result of defective workmanship or material in your dishwasher.

Food Soils Left on Dishes

- Choose another cycle for longer washing time.
- Check rack loading section for proper loading—avoid nesting items.
- Home water pressure may be too low—should be 20 to 120 pounds per square inch (psi).
- Check incoming water temperature. It should be at least 120°F (49°C). (See Factors Affecting Performance.)
- Check water hardness. For extremely hard water, it may be necessary to install a water softener. (See Detergent Chart.)
- Use fresh detergent.
- Check to make sure funnel in top rack is not blocked.
- Make sure items are not blocking the spray arms, preventing them from rotating.
- Check to see if the rinse aid dispenser needs refilling.

Dishes not Dry

- Select Hot Dry option.
- Make sure the rinse aid dispenser is filled.
- Increase the amount of rinse aid. (See Rinse Aid.)
- Check the incoming water temperature. Be sure it is at least 120°F (49°C).
- Check for proper loading—avoid nesting items.
- Plastic items may need to be towel dried.
- Cups with a concave bottom will collect water.

Glassware/Flatware Spotted or Cloudy

- Check water hardness. For extremely hard water, it may be necessary to install a water softener. (See Detergent Chart.)
- Water temperature may be low. Avoid extremely low or high temperatures. (See

Factors Affecting Performance.)

- Avoid overloading and improper loading. (See Preparing and Loading Dishes.)
- Use fresh detergent. Old detergent is ineffective.
- Make sure rinse aid dispenser is filled.
- Check to see that proper amount of detergent is being used for cycle selected. Also, check phosphate level. (See Detergent Dispenser.)
- Home water pressure may be too low—it should be 20 to 120 pounds per square inch (psi).

Dishware Chipped

- Load with care and do not overload. (See Preparing and Loading dishes.)
- Place delicate items in top rack.
- Place glasses securely against pins and not over pins.
- Load items so they are secure and don't jar loose when moving racks in and out. Move racks in and out slowly.
- Make sure tall glasses and stemware will clear top of tub when rack is pushed in.
- Fine antique china and crystal should be hand-washed.

Dishware Stained or Discolored

- Tea and coffee can stain cups. Remove the stains by hand washing in a solution of 1/2 cup (120 ml) bleach and one quart (1 L) of warm water. Rinse thoroughly.
- Iron deposits in water can cause a yellow or brown film. A special filter installed in the water supply line will correct this problem. (See Removing Spots and Film.)
- Aluminum utensils can leave gray/black marks when they rub against other items. Load properly.
- Certain high acid foods can cause discoloration of stainless steel and plastics if allowed to sit for a long period. Use the Rinse/Hold cycle or rinse by hand if not operating dishwasher at once.
- Mixing stainless steel and silver utensils in silverware basket can cause pitting of the stainless steel blades. Avoid mixing stainless steel and silver.



Solutions to Common Dishwashing Problems

(continued)

Etching

- Using too much detergent in soft or softened water causes this film that cannot be removed.
- Adjust the amount of detergent based on the water hardness. (Check Detergent Chart.)
- Lower the water temperature.
- Use the Cool Dry option.

Detergent Left in Cups

- Detergent may be old. Discard and use fresh detergent.
- Be sure water action can reach the dispenser.
- Check to see if cycle has been completed.
- Make sure items do not prevent the detergent dispenser from opening.

Dishwasher Leaks

- Use only fresh detergent designed for automatic dishwashers. Measure detergent carefully. Try a different brand.
- Spilled rinse aid can cause foam and lead to overflowing. Wipe up any spills with a damp cloth.
- Check to see that dishwasher is level. (See Installation Instructions.)

Normal Sounds You Will Hear

- Normal sounds include water fill, water circulation and motor sounds.
- There is a noticeable change in sound when the wash action switches between the lower and middle spray arm. This is normal since each spray arm has its own sound.
- It is normal for dishwasher to pause (no sound) when the wash action is switching between the lower and middle spray arms.

Water in Bottom of Tub

- Water left in bottom of tub after cycle is complete is not normal. If water remains in the bottom of the tub, dishwasher may not be draining properly. (See Dishwasher Does Not Drain Properly.)

Vapor at Vent

- Water vapor escapes from the vent when the dishwasher goes into the drying part of cycle. This is normal.

Dishwasher Won't Run

- Check to see if circuit breaker is tripped or if a fuse is blown.
- Make sure water supply is turned on.
- Check to see if cycle is set correctly. (See Operating Instructions.)
- Is dishwasher set for delay start option?
- Make sure door is closed and latched.

Dishwasher Does Not Drain Properly

- If unit is hooked up to a food waste disposer, make sure the disposer is empty.
- Check to see if the knockout plug has been removed from inside the food waste disposer inlet.
- Check to see if drain hose is kinked.
- Make sure cycle is complete, not in a pause.

Cycle Takes a Long Time

- Is cycle in a water heating delay?
- Has the delay start option been selected?

Dishwasher Won't Fill

- Is water supply turned on?
- Does overflow protector move up and down freely? (See Overflow Protector section.)

Dishwasher Has an Odor

- Soiled dishes left in dishwasher too long can create an odor. Use Rinse/Hold cycle.
- There will be a "new" smell when first installed. This is normal.
- Check to see if unit is draining properly. (See Dishwasher Does Not Drain Properly.)

Stains on Tub Interior

- Washing large amounts of dishware with tomato based soil can cause a pink/orange appearance. This will not affect performance and will gradually fade over time. Pre-rinsing or using the Rinse/Hold cycle will reduce the chance of staining. Using Cool Dry option will lessen staining.



Solutions to Common Dishwashing Problems

(continued)

Removing Spots and Film

Hard water can cause lime deposit buildup on the interior of the dishwasher. Dishes and glasses may also get spots and film for a number of reasons. (See Glassware/Flatware Spotted or Cloudy section.) To remove buildup, spots and film, clean using the following instructions:

1. Load clean dishes and glasses in normal manner. Do not load any metal utensils or silverware.
2. Do not add detergent.
3. Select the POTS & PANS or HEAVY WASH cycle. Close and latch door to start.
4. Allow dishwasher to run for 25 minutes to reach the main wash portion of cycle.
5. Unlatch and open door and pour 2 cups of white vinegar into the bottom of dishwasher.
6. Close and latch door and allow the cycle to finish.

Note: If these conditions persist, a home water softener should be considered.

Consumer Services

Keep your bill of sale, delivery slip or some other appropriate payment record. The date on the bill establishes the warranty period should service be required.

Dishwasher Warranty

Warrantor: Frigidaire Company, a division of White Consolidated Industries, Inc.

Covered

Full One Year Parts and Labor Warranty

For one year from date of purchase, Frigidaire Company will repair or replace any part of the appliance that proves to be defective in materials or workmanship.



Limited One Year Parts and Labor Warranty (State of Alaska only)

All terms stated above apply except all of the technician's travel costs to the home for service and any costs for pickup and delivery of the appliance (required because of service), are excluded.

Extended Limited 2nd Year Warranty

For two years from date of purchase, Frigidaire Company will provide a replacement (or functional equivalent), for any part in the water distribution system that proves to be defective in materials or workmanship. Associated inlet and drain plumbing parts are not included. The consumer must pay for all labor and service charges, and the cost to ship the part(s) to the nearest authorized servicer.

Extended Limited 2nd-10th Year Warranty

For ten years from date of purchase, Frigidaire Company will provide a replacement tub or door liner if the original tub or door liner fails to contain water because of a manufacturing defect. Door seals are not included. The consumer must pay for all labor and service charges, and the cost to ship the replacement part(s) to the nearest authorized servicer.

Not Covered

- Service calls where the problem is *not the fault* of the appliance. Examples—applicable to various appliance types but not limited to the following things:
 - Service calls to remove shipping devices; to level your appliance; to correct leaks at water inlet hose connections; to correct improper placement of drain hose in drain; to turn gas supply line on; to correct an improper exhaust system or to connect your appliance to your exhaust duct; to advise you on proper setting of controls or on proper use of your appliance; to correct installation of appliance; to replace owner-accessible light bulbs or fluorescent tubes.
 - Service calls where the problem is due to house wiring or improper voltage supply; a blown fuse or tripped circuit breaker; a slow or backed-up drain; a weak or spongy floor; insects, rodents or pests; frozen water lines in your appliance or house; improper power cord connections to appliance; blockage or restrictions in house exhaust duct or hood; appliance installed outside, exposed to elements.
- Repairs when product is used in dwellings with multiusers (such as in community-type complexes).
- Damage to your appliance caused by misuse, fire, flood, acts of God, or by using parts and/or service not approved by Frigidaire Company Consumer Services or an authorized Frigidaire Servicer.
- Consequential or incidental damages such as property damage and incidental expenses resulting from any breach of this written or any implied warranty.**

Note: Some states do not allow the exclusion or limitation of incidental or consequential damages, so this limitation or exclusion may not apply to you.
- Expenses to make appliance accessible for servicing (for instance, removal of cabinets, cabinet doors or molding).
- Service calls to products with serial plates that have been removed, altered, and that cannot be read well.



Warranty (continued)

Conditions

- This warranty gives you specific legal rights; you may have other rights, which vary from state-to-state. We authorize no one to change or make additions to this warranty.
- Service and installation must be provided by Frigidaire Company Consumer Services, or by an authorized Frigidaire Company Servicer. Use only genuine Frigidaire Company Consumer Parts.
- Product features/specifications are subject to change without notice.
- In the event a product cannot be repaired, a usage charge will be incurred.
- The consumer must:
 - properly use and maintain appliance.
 - read and follow all warning/safety instructions in the instruction manuals and on the product.
 - read and follow all instructions in the Use & Care Manual, the Installation Instructions and on the product.
 - have product properly installed in line with all local, plumbing, electrical and/or gas codes. Appliance must be properly connected and grounded to a power supply of sufficient voltage.
 - have the product moved out of place and back into place (if moving the appliance is essential for service). If product cannot be moved by the consumer, the servicer will not be liable for damages to the floor.



To Obtain Parts and Service

- Contact Frigidaire Company Consumer Services or an authorized Frigidaire Servicer.

- If there is a question on where to obtain service, call or write our Consumer Assistance Center at:

800•944•9044
Frigidaire
P.O. Box 7181
Dublin, OH 43017

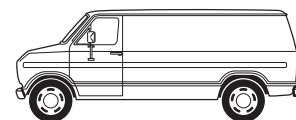

Versión en español

Si desea obtener una copia en español de este Manual del Usuario, sírvase escribir a la dirección que se incluye a continuación. Solicite la P/N 154285401.

Spanish Use & Care Manual
Frigidaire Company
P.O. Box 9061
Dublin, OH 43017-0961

Visit Frigidaire Company's Web Site at
<http://www.frigidaire.com>

Consumer Services

Dishwasher Warranty — Canada

WARRANTOR:

Frigidaire Canada
866 Langs Drive
Cambridge, Ontario
N3H 2N7

This dishwasher is a branded product of Frigidaire Canada.

WARRANTY PERIOD:

For the first year after purchase by the original consumer/owner:

For the second and third year after purchase by the original consumer/owner:

For the second through tenth year after purchase by the original consumer/owner.

For the useful life of the dishwasher by the original consumer/owner.

For service under this warranty, contact your local dealer/retailer, authorized FRIGIDAIRE PARTS AND SERVICE depot, or:

FRIGIDAIRE PARTS AND SERVICE

866 Langs Drive
Cambridge, Ontario
N3H 2N7
Tel.: (519) 653-0095
Fax: (519) 653-5761

WARRANTOR WILL THROUGH ITS AUTHORIZED SERVICE DEPOT:

Pay all costs to repair or replace any defective parts.

Pay all costs (excluding labour) to repair or replace defective heating element and water distribution system including the circulation pump/motor, drain pump/motor, lower spray arm system, middle spray arm system, delivery tube system and filtration system.

Pay all costs (excluding labour) to repair or replace a defective inner door liner arising out of the manufacturing process.

Pay all costs (excluding labour) to repair or replace a defective polypropylene tub arising out of the manufacturing process.

WARRANTY APPLIES TO:

- Products purchased and installed in Canada for personal single family household use.
- Defects resulting or arising out of the manufacturing process.
- Products bearing legible manufacturer's model and serial numbers.
- Replacement parts only for the remainder of the original warranty.

WARRANTY DOES NOT APPLY TO:

- Transportation damage.
- Supply and replacement of porcelain, fuses, glass and light bulbs.
- Parts and service supplied or obtained from other than FRIGIDAIRE PARTS AND SERVICE or FRIGIDAIRE PARTS AND SERVICE authorized depots.
- Damage or failure as the result of abuse, improper or commercial use.

CONSUMER/OWNER RESPONSIBILITY:

- To provide proof of the original date of purchase by means of a bill of sale or payment record verifying purchase date.
- To pay all costs to make the appliance readily accessible for service.
- To ensure proper power supply and connection of the appliance to same.
- Proper installation, control setting and care of finish.

This warranty is in addition to any statutory warranties contained in any applicable legislation. The terms and conditions of this warranty are not intended to exclude or limit your rights under those statutes. The warrantor however reserves the right to charge transportation and travelling costs for distances in excess of 48 kilometres (30 miles) from the nearest FRIGIDAIRE PARTS AND SERVICE authorized service depot.

This warranty plus the statutory warranties mentioned are the only warranties given to the consumer/owner for this product.