

This Owner's Manual is provided and hosted by [Appliance Factory Parts](#).

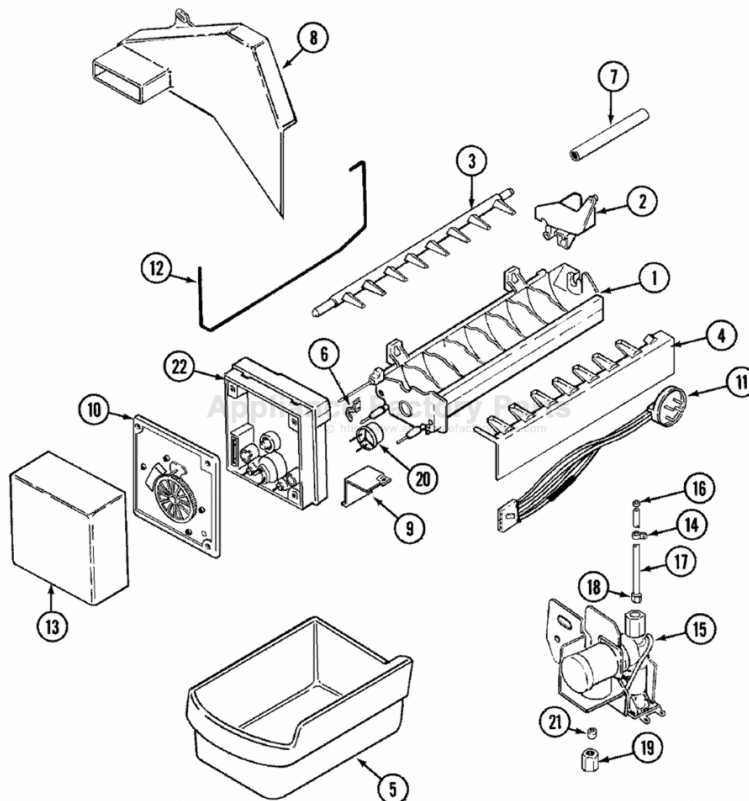

# MAYTAG RC223AV Owner's Manual

[Shop genuine replacement parts for MAYTAG  
RC223AV](#)



[Find Your MAYTAG Refrigerator Parts - Select From 2846 Models](#)

----- Manual continues below -----

# Your New Refrigerator .....Its Use and Care

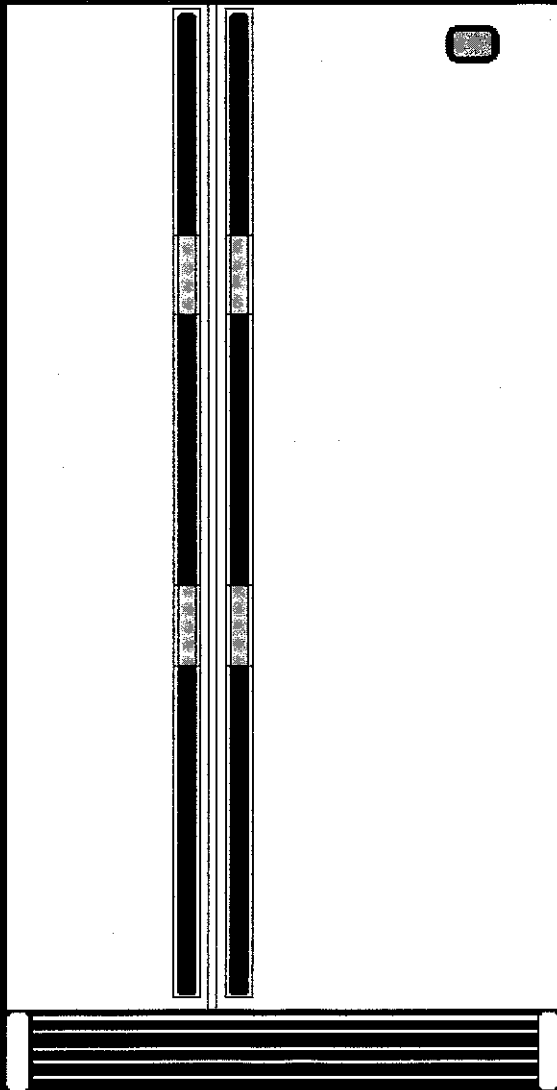

## Your New Refrigerator....2-3

General Features  
Appliance Registration  
Safety Instructions  
Installation  
Location  
Leveling  
No Defrosting

## Operating Instructions .....3

Setting Controls  
Warm Cabinet Surfaces

## Fresh Food Compartment

### Features.....3-4

Shelves  
Crispers  
Humidity Control Drawer  
Meat Keeper  
Temp Control Meat Keeper  
Beverage Rack

## Door Features.....4

Egg Storage  
Dairy Compartment  
Bottle Retainer  
Package Divider  
Magnetic Door Gaskets  
Door Bins

## Freezer Compartment

### Features.....4-6

Shelves  
Freezer Storage Drawer  
Ice Cube Service  
Optional Automatic Ice Maker  
Automatic Ice Maker  
Ice Dispensers  
Water Dispensers

## Care & Cleaning.....6

Replacing Light Bulbs  
Cleaning

## Energy Saving Tips.....6

## Going on Vacation!.....6

## How To Obtain Replacement Parts and Service.....7

## Problem Solving Table.....7

Note: This model refrigerator may not have all of the features listed above.

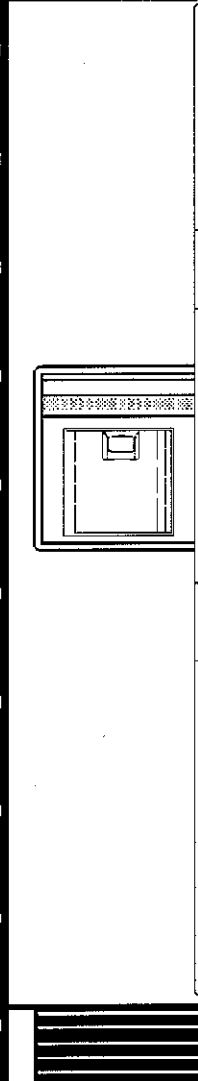

## SIDE-BY-SIDE REFRIGERATOR

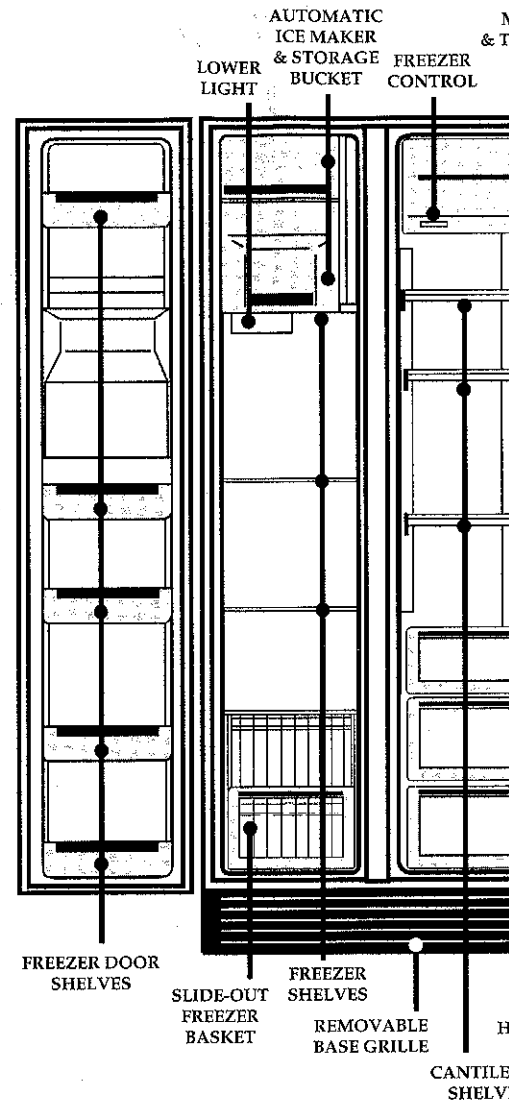
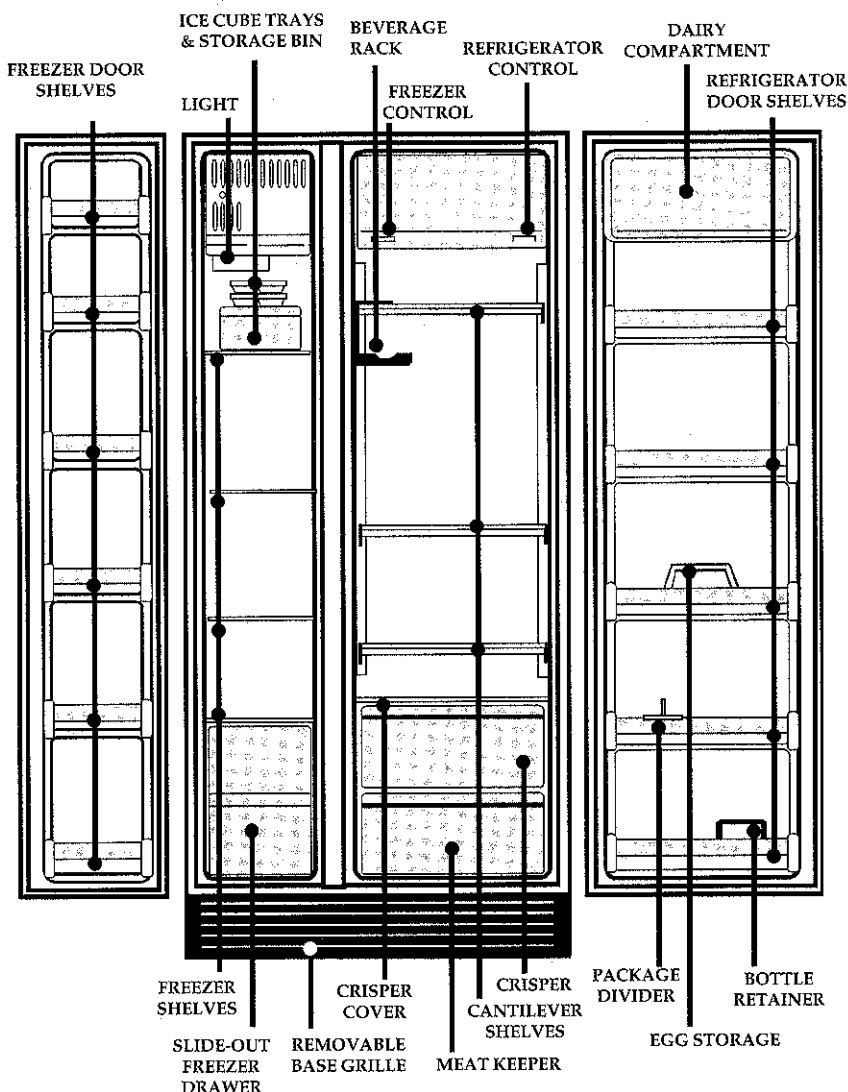

The model you have selected may not have all of these features.

## GENERAL FEATURES

MODEL NO. SERIAL NO. REV. NO. MAX AMPS ELEC RATING DESIGN PRESSURE PSIG 285 HI. & 140 LOW	 <small>UL</small> <small>URC</small>
--	--

Appliance  
Registration

Your new refrigerator is designed for ease of cleaning and reliable operation. It will help you operate thoroughly. It will help you operate

Record the model number and space provided. They are found on the grille at the bottom of the cabinet to the left. Retain this Use & Care

Model No. \_\_\_\_\_

## Safety Instructions

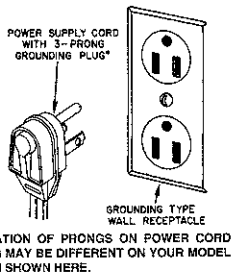

LOCATION OF PRONGS ON POWER CORD PLUG MAY BE DIFFERENT ON YOUR MODEL THAN SHOWN HERE.

To prevent the possibility of hazard due to electrical shock, never plug refrigerator into a receptacle that has not been grounded adequately and in accordance with local and national electrical codes.

## WARNING: Electrical Connection

*This appliance is designed to operate on a normal 115 volt, 15 amp, 60 cycle line. There should be a separate, grounded circuit serving this appliance only. Do not use an extension cord.*

*This appliance is equipped with a three-pronged grounding plug for your protection against possible electrical shock hazards. It must be plugged into a grounding receptacle. Where a standard two-prong wall receptacle is encountered, it is the personal responsibility and obligation of the customer to have it replaced with a properly grounded three-prong wall receptacle. Do not, under any circumstances, cut or remove the third (ground) prong from the power cord. Do not use an adapter plug.*

## Follow these safety guidelines:

- Unplug refrigerator before cleaning condenser or replacing a light bulb.
- In case of power failure, minimize door openings. Frozen foods that have thawed completely should not be refrozen.
- Do not operate refrigerator in the presence of explosive fumes.
- If you're replacing an older refrigerator, remove the doors from the out-of-use model to prevent child entrapment and suffocation.
- Children should not climb, hang or stand on doors or shelves.

## Installation

Your new refrigerator was packed carefully for shipment. Remove and discard shelf packing clips (if used) located just above each shelf where they hook onto the frame. To remove plastic clips, wiggle the clips sideways and pull straight out.

## Location

When considering where to locate the refrigerator, keep these points in mind:

- Allow for a free flow of air through the front base grille.
- Install refrigerator where room temperature will not go below 55° F., because the refrigerator will not run frequently enough to maintain proper temperature in the freezer.
- Allow a minimum 1/2" clearance on sides, top and back for ease of installation. If refrigerator is placed with door hinge side against a wall, you may want to allow additional space so door can open wider.

## Leveling

To enhance its appearance and maintain performance, your refrigerator should be level. Depending on the model that you have selected, the refrigerator may be leveled in one of these two ways.

Refrigerator models that have four wheels and a leveling screw beneath each front corner at the base of the cabinet can be adjusted by turning in or out as required (see Fig. 1).

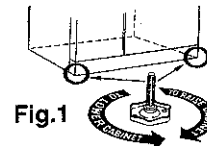

Fig. 1

Refrigerator models that have adjustable wheels can be leveled by removing the base grille and adjusting the wheels with a screwdriver (see Fig. 2). To lock the cabinet in place, turn down one or both locking feet, located near the front wheels. Rear leveler feet are not required.

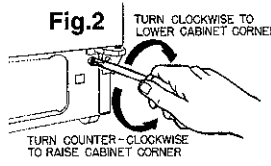

Fig. 2

If the floor is not level and it is necessary to raise the rear of the cabinet, we suggest rolling the rear wheels on to a piece of plywood or other shim material.

## No Defrosting

Your refrigerator is designed to defrost itself automatically.

## Operating Instructions

### Setting Controls

#### Certain Models Only

Your refrigerator has two temperature controls: one for the fresh food compartment and one for the freezer. The controls are located at the top, rear of the fresh food compartment. To adjust the controls, grasp the underside of the control and turn.

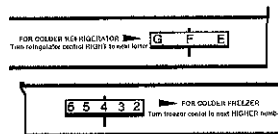

The fresh food compartment has settings from A (warmest) to J (coldest). Initially set this control on F.

The freezer control has settings from 1 (warmest) to 9 (coldest). Initially set this control to 4. It is recommended that the coldest freezer setting (9) be used for short periods only. Your refrigerator will run continuously for several hours when you first start it. This is normal.

In a day or so, you may decide one or both compartments should be colder or warmer. If so, adjust the control(s) as indicated below:

To start:	Set fresh food control on F. Set freezer control on 4.
Refrigerator too WARM	Turn fresh food control to next higher letter.
Refrigerator too COLD:	Turn fresh food control to next lower letter
Freezer too WARM:	Turn freezer control to next higher number.
Freezer too COLD:	Turn freezer control to next lower number.
Refrigerator OFF.	Set fresh food control to OFF.

#### Certain Models Only

Your refrigerator has two temperature controls: one for the fresh food compartment and one for the freezer. The controls are located at the top, rear of the fresh food compartment.

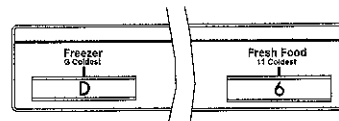

The fresh food compartment (coldest). Initially set this control to F.

The freezer control has settings from 1 (warmest) to 9 (coldest). Initially set this control to 4. It is recommended that the coldest freezer setting (9) be used for short periods only. Your refrigerator will run continuously for several hours when you first start it. This is normal.

In a day or so, you may decide one or both compartments should be colder or warmer. If so, adjust the control(s) as indicated below:

To start:	Set fresh food control on F. Set freezer control on 4.
Refrigerator too WARM	Turn fresh food control to next higher letter.
Refrigerator too COLD:	Turn fresh food control to next lower letter
Freezer too WARM:	Turn freezer control to next higher number.
Freezer too COLD:	Turn freezer control to next lower number.
Refrigerator OFF.	Set fresh food control to OFF.

## All Models

Except when starting the refrigerator, you should not turn the control more than one number or letter. Turn the control to stabilize before resetting. Frequent adjustments will have some effect on the refrigerator's performance.

NOTE: Turning the control to the coldest setting will cause cooling in BOTH compartments. To stop the refrigerator from cooling in BOTH compartments, turn the control to a warmer setting.

## Warm Cabinet

At times, the front surface of the refrigerator may feel warm to the touch. This is a normal condition. It is caused by condensing on the cabinet. To stop this, you first start the refrigerator. After a prolonged door opening, the refrigerator will feel warm.

## Fresh Food Compartment

### Shelves

**Slide-Out Shelves:** To move on plastic rails a shelf forward for access, pull it toward you. To move a shelf toward the rear, lift the front edge slightly and pull it completely out. (Some models have cantilever shelves to contain spills. Height of shelves may vary. Be careful that the movable shelves do not fall out.)

**Adjustable Cantilever Shelves:** Glass or wire shelves may be used with your refrigerator. To move a shelf, lift the rear edge up a fraction of an inch and pull it straight out. To lock the shelf into another position, tilt the front up. Insert the shelf into desired frame opening and let the shelf settle into place.

## Fresh Food Compartment Features

### Crispers

**Sealed Crisper:** These special drawers are ideal for storing vegetables and fruit. Keep your crispers tightly closed to insure freshness. Storing leafy vegetables, such as celery and lettuce in plastic bags, reduces moisture evaporation. The fruit and vegetable crispers are completely removable for cleaning (hand wash only). The crisper cover also serves as a refrigerator storage shelf. To remove the cover, pull it straight out.

### Humidity Control Crispers

Dispenser models have humidity controlled crispers that are ideal for storing fresh produce.

The humidity slide control is located on the front of the drawer. For storing fruits, the control should generally be set at the "LOW" position. For storing vegetables, the control should generally be set at the "HIGH" position. Odorous foods should be wrapped.

### Meat Keeper

A sliding drawer is provided for short term storage of fresh meat. This Meat Keeper is suspended from one of the rails at the bottom of the compartment. It slides out to the front so you can easily reach all items stored within. **KEEP YOUR MEAT KEEPER TIGHTLY CLOSED AT ALL TIMES.**

Your Meat Keeper may have a control lever along the left side with which you can vary the internal temperature. With the lever set in the "COOL" position, the temperature in the drawer is the same as the surrounding air in the food compartment. With the lever set at the "COLD" position, the temperature in the drawer is colder and most good quality meats can be stored for several days. Select the lever position that keeps the meat at the temperature of your choice.

All meats or poultry should be stored in their original store wrappings or in plastic bags to reduce the evaporation of moisture from them.

To remove the meat pan, pull it out until it stops. Then apply a little more pressure and pull completely out.

### Temperature Control Meat Keeper

Your model may have a Temperature Controlled Meat Keeper which provides short term storage of fresh meat without freezing. The control knob is located between the refrigerator control and the freezer control on the refrigerator light shield. As the control knob is moved from the "COOL" setting toward the "COLD" setting, the temperature will get colder enabling good quality meat to be stored for several days. Select the control knob position best suited for keeping the meat at the temperature of your choice.

All meats or poultry should be stored in their original store wrappings or in plastic bags to reduce the evaporation of moisture from them.

To remove the meat pan, pull it out until it stops. Then apply a little more pressure and pull completely out.

### Beverage Rack

Your model may have a multi-use Beverage Rack. Position the beverage rack to rest on the left hand side of a refrigerator shelf and lay either an egg carton, bottle or cans on the rack.

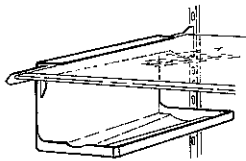

## Door Features

### Egg Storage

The egg tray holds a "dozen-plus" eggs and fits securely on a door shelf. This tray can be removed and carried to your working area.

### Dairy Compartment

Special, extra deep dairy compartment bins store butter and cheeses.

### Bottle Retainer

Some models have a bottle retainer located on the lower refrigerator door shelf. It prevents tall bottles from falling out when the refrigerator door is opened or closed. To attach the retainer in models with door bins, have the smooth side of the retainer facing forward, align the retainer with the front lip of the bin and snap into position. The bottle retainer can be adjusted to any position on the bin by sliding sideways.

Other models may have a formed rod in the lower door shelf. Grasp each end of the retainer rod and move up or down as required. Before you close the door, make sure the formed rod is in the down position.

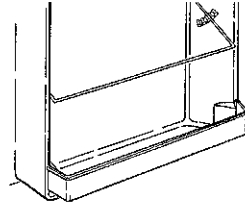

### Package Dividers

Some models have a Package Divider located on the refrigerator door shelves. It provides upright storage for packages or bottles. The divider can be adjusted to any position on the shelf by sliding sideways.

### Magnetic Door Gaskets

Door gaskets are magnetized to insure an air-tight seal. The gaskets cling to the cabinet front, once the doors are closed to within their magnetic range.

### Door Bins

Some models have removable bins in the door that are adjustable. Lift the bin straight up until it clears the retainers on the door liner and pull straight out. Reverse this procedure when replacing a bin. Other shelves are easily removed by lifting the shelf up while pulling it out. Reverse this procedure when replacing it. There are several different features available for the refrigerator doors, depending upon the model you have selected.

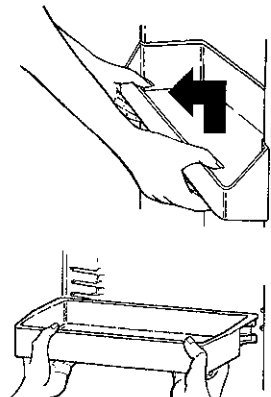

### Easy Clean Door Shelf Fronts

Certain models have door shelf fronts that can be removed for easy cleaning of the door liner and shelf fronts. Lift the shelf front straight up until it clears the retainers on the door liner and pull straight out. Reverse this procedure when replacing door shelf fronts.

## Freezer C

### Freezer Shelf

To remove a freezer shelf, pull it straight out. Follow the procedure.

### Freezer Storage

The slide-out freezer shelf is removed by pulling it straight out, then lift the front edge. If you notice that the shelf does not slide smoothly or easily, apply petroleum jelly to the points as shown. The slide rails at the bottom of the freezer compartment make contact.

### Ice Cube Serv

To release ice cube tray, twist both ends.

### Optional Auto

Some refrigerators have an optional automatic ice maker. Order the ice maker kit. The kit contains instructions and other information.

### Automatic Ice

#### MODELS WITH A

The water inlet tubing is connected to the water valve on the ice maker to the instructions furnished with the ice maker.

The automatic ice maker produces ice cubes. With this unit, the amount of filling ice cube tray is determined by the amount of ice produced.

The amount of ice produced is controlled by the amount of water produced. We suggest you adjust the controls at their midpoint. If the amount of ice produced is abnormally low, the amount of water produced is abnormally low.

# Automatic Ice & Water Dispensers

After your model has been installed and the water supply connected to the ice maker, it may be 8 to 12 hours before the ice maker furnishes any usable ice cubes. The first one or two harvests will probably contain undersized and irregular cubes because of air in the supply line.

The initial harvest may also contain impurities from the new water supply piping. Therefore, all cubes from the first two or three harvests should be discarded. Once this initial starting period is past, your ice maker will perform steadily and dependably.

Ice cubes that have been in the ice storage bin for a considerable length of time may pick up off-flavor taste, stick together and gradually become smaller. We suggest that these cubes be thrown away. We also suggest using an open box of baking soda in the refrigerator for food odor absorption.

Certain sounds may accompany the various cycles of the ice maker. The motor may have a slight hum--the cubes will rattle as they fall into an empty storage pan--the water valve may click or "buzz" occasionally. All of these sounds are normal and should be ignored.

The ice maker has a wire sensor arm that is connected to a shut-off switch. This arm stops the mechanism when the ice cube storage pan is full, and restarts it after several ice cubes have been used. You can use the stop arm to stop all production of ice at any time. All you need to do is raise the arm into the OFF position.

## The ice maker should be turned off (arm up) when:

1. Ice storage bin is to be removed for extended period of time.
2. Refrigerator is not to be used for a considerable length of time, such as vacations. Also, turn off the water supply to the ice maker in this instance, if practical.
3. Water supply is to be shut-off for several hours.

## HOW THE ICE MAKER WORKS:

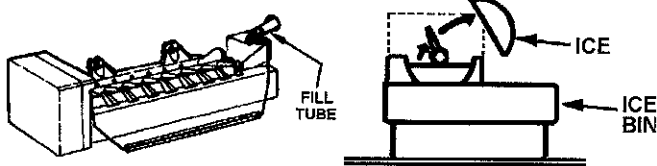

Water fills the empty cube mold when the freezer compartment has cooled to freezing temperature. Cold air is forced directly over the mold. When frozen, the cubes are rotated up and out of the mold. The sweeper arm ejects them into the storage bin below. The sensor arm senses when the bin is full and signals the ice maker to stop ejecting more cubes. Meanwhile, the mold has been refilled and cubes frozen so the new supply is ready when needed. As soon as ice is removed from the bin, the sensor arm signals that more is needed. The ice maker resumes operation by ejecting ready-and-waiting frozen cubes.

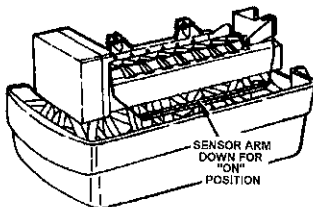

## FOR YOUR SAFETY

Do not place fingers or hands on the automatic ice making mechanism while the refrigerator is plugged in. This will help protect you from possible injury. It will also prevent interference with moving parts of the ejector mechanism and the heating element that releases the cubes.

Under certain rare circumstances, ice cubes may be discolored, usually appearing with a green-bluish hue. The cause of this unusual discoloration is apparently a combination of factors such as certain characteristics of local waters, household plumbing and the accumulation of copper salts in an inactive water supply line which feeds the ice maker.

Continued consumption of such discolored ice cubes may be injurious to health. If such discoloration is observed, discard the ice cubes and contact the dealer from whom the refrigerator was purchased.

## Dual Lever Dispenser - Ice and Water

### Ice Dispenser

Prevent ice cubes from missing your glass by holding it as high as possible below the ice chute. Press the glass against the padded lever at the left side of the fountain. To stop dispensing ice, release pressure enough to stop the dispenser motor and leave the glass in place to hold the door open until the ice stops falling. With practice, you will learn to anticipate when to release pressure to prevent an unwanted dispense of ice.

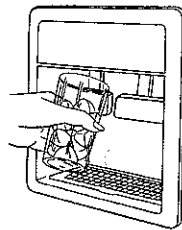

To remove the ice dispenser bin, lift the front of the bin and pull it straight out. Wash the bin occasionally in mild soap and lukewarm water. To replace the bin, push it all the way back until the bottom of the bin is behind the raised edge at the front of the shelf it rests upon. Make sure the tabs at the back of the bin that turn the spiral auger are positioned between the prongs from the auger motor.

**Note:** After installation, it may take two to three days to fill the ice storage bin with cubes. NEVER ADD ICE CUBES FROM ANOTHER SOURCE TO YOUR DISPENSER STORAGE BIN. THIS COULD CAUSE A JAM IN YOUR DISPENSER. If this happens, remove the storage bin and discard all ice cubes. Remove any clumps that are stuck in the chute at the front of the bin, the ice chute and those blocking the dispenser opening.

If the dispenser has not been used for a considerable length of time (10 days or more) ice may stick together forming clumps. This should be discarded and a fresh supply allowed to accumulate.

### Water Dispenser

To dispense water, press a container against the padded lever at the right side of the fountain. To stop the water flow, release pressure. After releasing pressure, hold the glass in place to catch the last few drops of water. To minimize splashing, hold the container as high as possible.

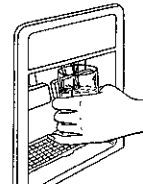

When you first operate your dispenser, or after reconnecting water to your refrigerator, air will escape from the dispenser for a moment before water begins to flow. Draw 10 glasses of water and empty them in the kitchen sink.

Do not discard water in the spill area. IS A SPILL AREA, the recessed area be removed with an ab cleaned occasional

**DISPENSER LIGHT** and on the right side light on or off.

**LOCK SWITCH.** Y located behind the p This push button sw

## Single Pad D Crushed Ice

### Water/Ice Control

For dispensing ice control must be moved to the "Ice" position (center). For crushed ice, move the control to the "Ice" position (left).

For dispensing chilled water, move the control to the "Water" position (right).

Water from the dispenser is colder water simply by holding a glass of water dispenser for a few seconds. It will be colder than a partial glass. Fill a glass to avoid splashing.

### Dispensing

To fill a glass, position the top portion of the glass against the press. **Hold the glass against the dispenser opening while the ice is falling outside the**

Some crushed ice may be scattered even though you select the "Ice" position. It happens occasionally and you may accidentally get char

When changing from ice to water, the dispenser will dispense. This may happen if the glass is in the storage bin

There may be a delay of a few seconds before the dispenser starts. Crushed ice pieces may be scattered if dispensed directly into a glass. They can crack or chip from the glass if they are against the act

Ice other than that produced by your ice maker should not be added to the ice storage bin--it may not crush and/or dispense properly.

For large quantities of cubed ice, remove the ice directly from the storage bin. Do not operate the ice dispenser continuously for more than five minutes.

If the ice dispenser is not used frequently, ice cubes may clump together and may need to be broken apart or discarded.

### To Stop Dispensing

Release the pressure on the pad and hold the container in position momentarily to catch the last pieces of ice or drops of water. The ice delivery door will remain open for a short time. When it closes you may hear a closing sound.

### Removing and Replacing the Automatic Ice Cube Dispenser Bin

Lift the front of the Automatic Dispenser bin and pull it straight out. Wash the bin occasionally in mild soap and lukewarm water. To replace the bin, push it straight back until it stops. Lift it up and over the stop, pushing it back into position. Make sure the tabs, at the back of the bin, that turn the spiral auger are positioned between the prongs from the auger motor.

## Care & Cleaning

### Replacing Light Bulbs

**DISCONNECT THE POWER CORD BEFORE REPLACING LIGHT BULBS.** To replace a light bulb at the upper rear, grasp the light shield near the ends and pull either the top or bottom out until the shield pulls free of the retainer lugs.

Use a 60 watt, standard base, appliance type bulb when replacing the upper refrigerator compartment light. The upper freezer compartment light requires a 40 watt standard base bulb.

**To replace the freezer light bulb;** (1) unhook the tabs on the top of the light shield by pressing in with the thumb on the center top of the light shield; (2) pivot shield down; (3) unscrew the bulb when cool and replace with a standard 40 watt appliance bulb; (4) pivot shield up into place, snapping the tabs into the slots.

**To replace the dispenser freezer light bulb;** (1) remove the ice cube dispenser bin and the top freezer shelf; (2) unhook the tabs on the top of the light shield by pressing in with the thumb on center top of the light shield; (3) pivot the shield down; (4) unscrew the bulb when cool and replace it with a standard 40 watt appliance bulb; (5) pivot shield up into place, snapping the tabs into the slots; and (6) replace the freezer shelf and the ice cube dispenser bin.

**DISPENSER LIGHT - DISPENSER MODELS ONLY.** For replacement, use a 120V, 7 watt bulb. Disconnect the power cord before replacing the light bulb.

### Cleaning

**DISCONNECT POWER CORD BEFORE CLEANING.** Your refrigerator can be rolled out for cleaning. Turn the levelers, at each front corner of the cabinet, counterclockwise until they turn freely. Then pull the cabinet straight out. If your model has an automatic ice maker, we recommend that you turn the water supply off before moving the cabinet.

After cleaning behind your model, push it back and turn the levelers clockwise to lock cabinet in place.

#### Inside

Clean both compartments and inner door panels with mild soap and water. **DO NOT** use an abrasive powder, solvent, polish cleaner or undiluted detergent. Use baking soda and warm water only on interior compartments and interior door liners. Rinse with clear water. Do not wash interior parts in your dishwasher. Be sure to wring out excess water from the sponge or cloth when cleaning in the area of controls, lights or electrical parts.

Glass shelves can be removed and completely immersed in warm water. **ALLOW GLASS TO WARM TO ROOM TEMPERATURE BEFORE IMMERSING.**

#### Outside

Keep the finish clean. Wipe with a clean, soft cloth lightly dampened with kitchen appliance wax or mild liquid dishwashing detergent. Dry and polish with a clean, soft cloth. Do not wipe the refrigerator with a soiled dishwashing cloth or wet towel. These may leave residue that can erode the paint. Do not use scouring pads, powdered cleansers, bleach or cleaners containing bleach because these products can scratch and weaken the paint finish.

Protect the paint finish. The finish on the outside of the refrigerator is a high-quality, baked-on paint finish. With proper care, it will stay new-looking and rust-free for years.

Your door gaskets are vinyl. They may be cleaned with a baking soda solution, soap and water or with a mild scouring powder.

### Removing Base Grille

Grasp the base grille at both ends and pull straight out. To replace the base grille, align the spring clips with the square openings in the cabinet and push each end in until the grille locks into place.

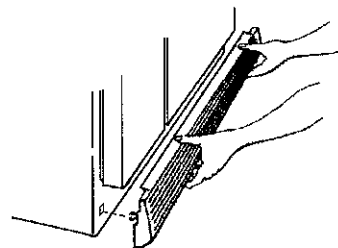

### Defrost Pan

Defrost water drains into a shallow pan beneath the cabinet and evaporates. During periods of high humidity, water could remain in the pan. This pan should be cleaned once a month with a strong solution of soap and water.

To remove the defrost pan, grasp the base grille at both ends and pull it straight out. Lift the front of the defrost pan and pull it straight out. To replace the defrost pan, position the side flange over the slide rails and push down on the center of the pan to snap it in place.

To replace base grille, align square openings in the grille with the cabinet and push down on the center of the grille to snap it in place.

### Condenser

To allow your refrigerator to operate properly, the condenser coils must be cleaned. The area around the condenser coils should be moved during routine cleaning. Move away from the wall and the area where the condenser coils are located after cleaning. To clean the condenser coils, pull out. After cleaning, re-

### Energy Saving

- Be sure refrigerator is not blocked.
- Check door seals at all places, top, bottom and sides.
- Check the temperature controls.
- Keep freezer full to help insulate the openings.
- Let hot dishes cool before putting them in the refrigerator.
- Cover liquids. If you spill, clean up immediately.

### Going On Vacation

If you will be gone for a long time, set the refrigerator to the setting. During longer trips, follow these steps:

- Remove all food.
- Disconnect from power.
- Clean the refrigerator.
- Leave doors open.

## HOW TO OBTAIN REPLACEMENT PARTS & SERVICE

**Problems? Save yourself the nuisance of unnecessary service calls; check the Problem Solving Table.**

The merchandise you have purchased from us has been carefully engineered and manufactured under strict quality standards and should give you satisfactory and dependable operation. However, like all mechanical merchandise, it may occasionally require adjustment, replacement parts or maintenance. Should you ever need assistance please contact or write the dealer from whom you purchased the refrigerator.

**Provide the following:**

1. Model, serial number and all of the other data shown on the model plate.
2. State briefly the trouble you are having.

**Should you still have a problem after following the above procedure, write to:**

Major Appliance Consumer Action Panel  
20 North Wacker Drive  
Chicago, IL 60606

MACAP is an industry sponsored by an independent group of consumer experts who receive and act on complaints from appliance owners.

**NOTE:** When writing about an unresolved service problem, please include the following information:

- a) Your name, address and telephone number.
- b) Model number, rev. number, and serial number (found behind the front grille).
- c) Name and address of dealer and date the appliance was bought.
- d) A clear description of the problem you are having.

## Problem Solving Table

Problems? Save yourself the nuisance of unnecessary service calls; check the Problem Solving Table.

<b>LOCATION</b> <ul style="list-style-type: none"><li>• Do not install refrigerator where temperature falls below 55°.</li></ul>	<b>WARM AIR FROM BOTTOM</b> <ul style="list-style-type: none"><li>• Normal air flow for condensation.</li></ul>
<b>NOISY OPERATION</b> <ul style="list-style-type: none"><li>• Sound level is more noticeable due to many features.</li><li>• Cabinet not level.</li><li>• Fan motor noise is normal.</li><li>• Weak floor.</li></ul>	<b>FRONT CABINET S WARM TO THE TOUCH</b> <ul style="list-style-type: none"><li>• Special design to limit condensation during periods of high humidity.</li></ul>
<b>CABINET VIBRATES</b> <ul style="list-style-type: none"><li>• Cabinet not level.</li><li>• Tubing vibration.</li><li>• Defrost pan not properly installed.</li><li>• Weak floor.</li></ul>	<b>ODOR IN CABINET</b> <ul style="list-style-type: none"><li>• Food left uncovered.</li><li>• Check crisper for spoiled food.</li></ul>
<b>WATER ON FLOOR UNDER CABINET</b> <ul style="list-style-type: none"><li>• Defrost pan missing or not positioned properly. Remove base grille to gain access.</li><li>• Defrost pan needs to be emptied due to high humidity conditions.</li></ul>	<b>FOODS DRY OUT (FRESH OR FROZEN)</b> <ul style="list-style-type: none"><li>• Packages not wrapped or properly sealed.</li><li>• Crisper not tightly closed.</li><li>• Temperature control set too low.</li></ul>
<b>SIZZLING SOUND IN FREEZER</b> <ul style="list-style-type: none"><li>• Normal sound cause by defrost water dripping on defrost heater.</li></ul>	<b>EXCESSIVE MOISTURE IN CRISPER</b> <ul style="list-style-type: none"><li>• Food not wrapped properly.</li><li>• Hot, humid weather.</li></ul>
<b>REFRIGERATOR RUNS TOO FREQUENTLY</b> <ul style="list-style-type: none"><li>• Frequent running provides more stable temperatures.</li><li>• Too many door openings.</li><li>• Prolonged door openings.</li></ul>	<b>MOISTURE ON OUTSIDE SURFACE</b> <ul style="list-style-type: none"><li>• This condition can occur in hot and humid weather and is most evident during the hottest hours.</li><li>• Check energy saver switch.</li></ul>
<b>REFRIGERATOR RUNS TOO LONG</b> <ul style="list-style-type: none"><li>• Under normal conditions modern refrigerators run a greater percentage of the time.</li><li>• Warm room temperature.</li><li>• Prolonged or frequent door openings.</li><li>• Condenser needs cleaning. See detail in operating Manual.</li></ul>	<b>MOISTURE ON INSIDE CABINET WALLS</b> <ul style="list-style-type: none"><li>• Can occur during hot, humid weather with frequent or prolonged door openings.</li><li>• Door not closing properly.</li></ul>
<b>REFRIGERATOR WILL NOT RUN</b> <ul style="list-style-type: none"><li>• Temperature control turned to Off.</li><li>• Power cord not plugged in.</li><li>• No power at electrical outlet.</li><li>• House fuse blown or circuit breaker tripped.</li><li>• Refrigerator is in automatic defrost for approximately 20 minutes.</li></ul>	<b>FREEZER NOT FREEZING PROPERLY (ice cream, concentrated juices)</b> <ul style="list-style-type: none"><li>• Products with high sugar content do not harden completely with normal freezing.</li></ul>
	<b>FRESH FOOD COMPARTMENT TOO WARM</b> <ul style="list-style-type: none"><li>• Refrigerator control set too low.</li><li>• Freezer control set at coldest position.</li><li>• Prolonged door openings.</li></ul>

The manufacturer, whose policy is one of continuous improvement, reserves the right to change specifications without notice.