

This Owner's Manual is provided and hosted by [Appliance Factory Parts](#).



LG LW2412ER Owner's Manual

[Shop genuine replacement parts for LG LW2412ER](#)



[Find Your LG Air Conditioner Parts - Select From 2328 Models](#)

----- Manual continues below -----



LG

Life's Good

ENGLISH

ESPAÑOL

OWNER'S MANUAL

AIR CONDITIONER

Please read this manual carefully before operating your set and retain it for future reference.

TYPE: WINDOW

MODELS: **LW1512ER, LW1812ER, LW2412ER**

TABLE OF CONTENTS

Safety Precautions	3
Before Operation	7
Introduction	8
Electrical Safety	9
Installation	11
Operating Instructions	16
Maintenance and Service	20



FOR YOUR RECORDS

Write the model and serial numbers here:

Model #

Serial #

You can find them on a label on the side of each unit.

Dealer's Name

Date Purchased

■ Staple your receipt to this page in the event you need it to prove date of purchase or for warranty issues.



READ THIS MANUAL

Inside you will find many helpful hints on how to use and maintain your air conditioner properly. Just a little preventive care on your part can save you a great deal of time and money over the life of your air conditioner.

You'll find many answers to common problems in the chart of troubleshooting tips. If you review our chart of

Troubleshooting Tips first, you may not need to call for service at all.



PRECAUTION

- Contact the authorized service technician for repair or maintenance of this unit.
- Contact the installer for installation of this unit.
- The air conditioner is not intended for use by young children or invalids without supervision.
- Young children should be supervised to ensure that they do not play with the air conditioner.
- When the power cord is to be replaced, replacement work shall be performed by authorized personnel only using only genuine replacement parts.
- Installation work must be performed in accordance with the National Electric Code by qualified and authorized personnel only.



Safety Precautions

To prevent injury to the user or other people and property damage, the following instructions must be followed.

■ Incorrect operation due to ignoring instruction will cause harm or damage. The seriousness is classified by the following indications.

⚠ WARNING This symbol indicates the possibility of death or serious injury.

⚠ CAUTION This symbol indicates the possibility of injury or damage to properties only.

■ Meanings of symbols used in this manual are as shown below.

	Be sure not to do.
	Be sure to follow the instruction.

⚠ WARNING

■ Installation

Don't use a power cord, a plug or a loose socket which is damaged.

- Otherwise, it may cause a fire or electrical shock.

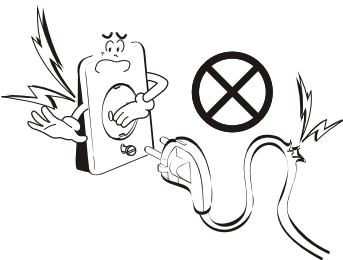

Always plug into a grounded outlet.

- Otherwise, it may cause a fire or electrical shock.

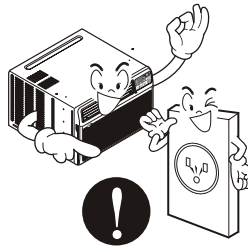

Do not modify or extend the power cord length.

- It will cause electric shock or fire due to heat generation.

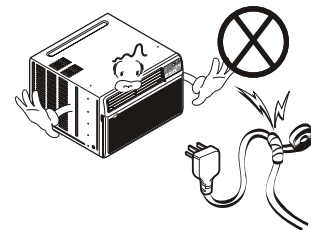

Do not disassemble or modify products.

- It may cause failure and electric shock.

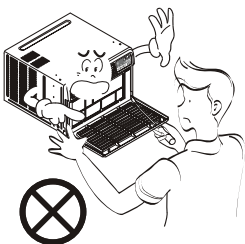

Be caution when unpacking and installing.

- Sharp edges may cause injury.

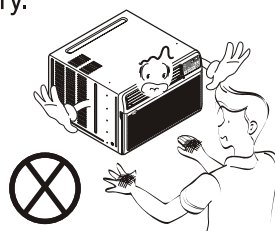

Do not use the power cord near flammable gas or combustibles such as gasoline, benzene, thinner, etc.

- It may cause explosion or fire.

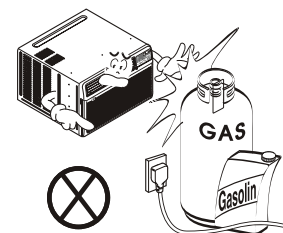

■ Operation

Do not place heavy object on the power cord and take care so that the cord should not be pressed.

- There is danger of fire or electric shock.

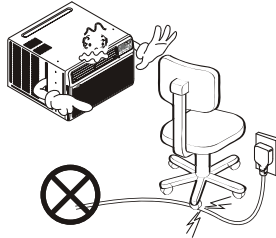

Do not share the outlet with other appliances.

- It will cause electric shock or fire due to heat generation.

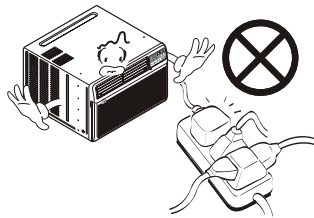

Take the power plug out if necessary, holding the head of the plug and do not touch it with wet hands.

- Otherwise, it may cause a fire or electrical shock.



Do not place the power cord near a heater.

- It may cause fire and electric shock.

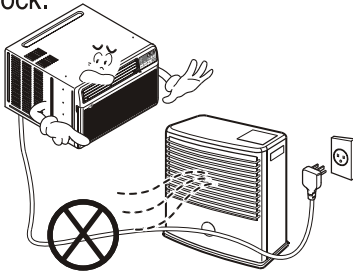

Do not allow water to run into electric parts.

- It will cause failure of machine or electric shock.



Use a soft cloth to clean. Do not use wax, thinner, or a strong detergent.

- The appearance of the air conditioner may deteriorate, change color, or develop surface flaws.

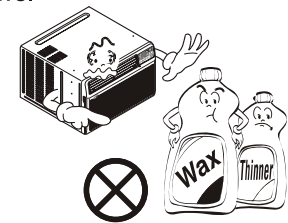

Unplug the unit if strange sounds, odors, or smoke come from it.

- Otherwise it may cause fire and electric shock accident.

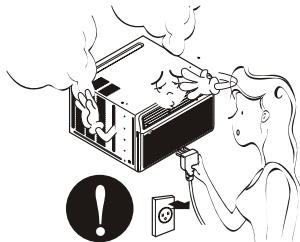

Do not open the suction inlet grill of the product during operation.

- Otherwise, it may electrical shock and failure.



If water enters the product, turn off the the power switch of the main body of appliance. Contact service center after taking the power-plug out from the socket.



Ventilate the room well when using this appliance together with a stove, etc.

- An oxygen shortage may occur.

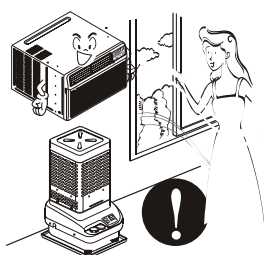

Turn off the power and breaker firstly when cleansing the unit.

- Since the fan rotates at high speed during operation, it may cause injury.

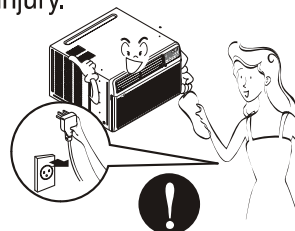

Turn off the main power switch when not using it for a long time.

- Prevent accidental startup and the possibility of injury.

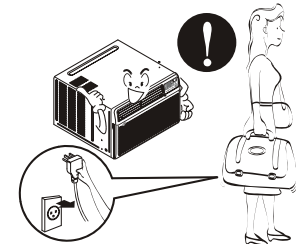

Do not operate or stop the unit by inserting or pulling out the power plug.

- It will cause electric shock or fire due to heat generation.

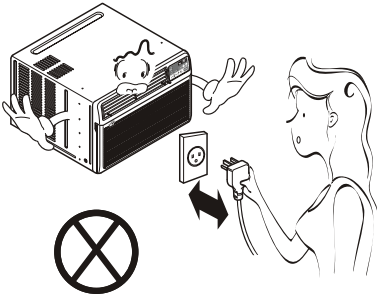

Do not damage or use an unspecified power cord.

- It will cause electric shock or fire.

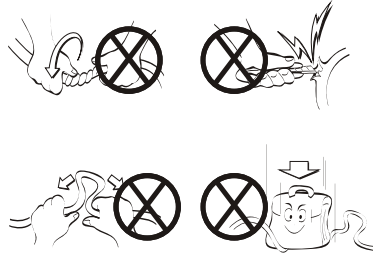

Do not operate with wet hands or in damp environment.

- It will cause electric shock.

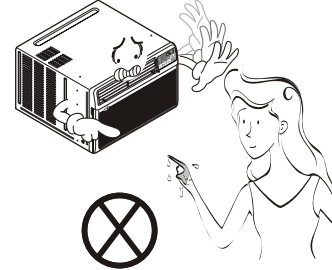

Hold the plug by the head (not the cable) when taking it out.

- It may cause electric shock and damage.



When gas leaks, open the window for ventilation before operating the unit.

- Otherwise, it may cause explosion, and a fire.

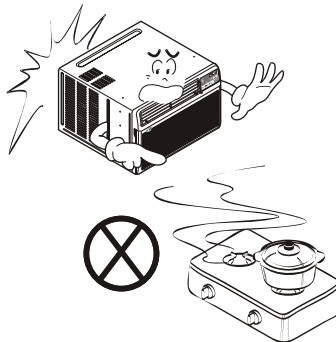

Never touch the metal parts of the unit when removing the filter.

- They are sharp and may cause injury.

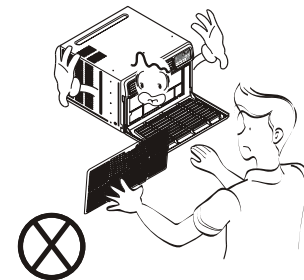

⚠ CAUTION

■ Installation

Install the product so that the noise or hot wind from the outdoor unit may not cause any damage to the neighbors.

- Otherwise, it may cause dispute with the neighbors.

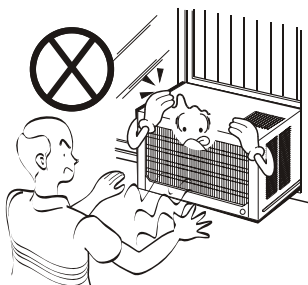

Keep level parallel in installing the product.

- Otherwise, it may cause vibration or water leakage.

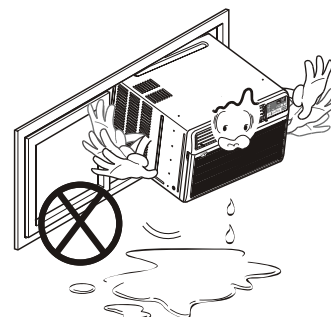

■ Operation

Do not put a pet or house plant where it will be exposed to direct air flow.

- It may cause injury.

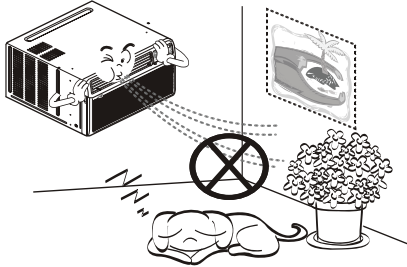

Do not block the inlet or outlet of air flow.

- It may cause product failure.

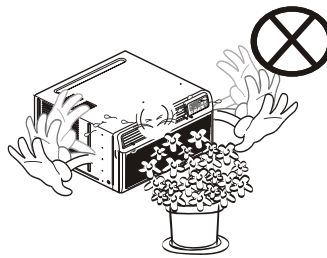

Use a soft cloth to clean. Do not use wax, thinner, or a strong detergent.

- The appearance of the air conditioner may deteriorate, change color, or develop surface flaws.

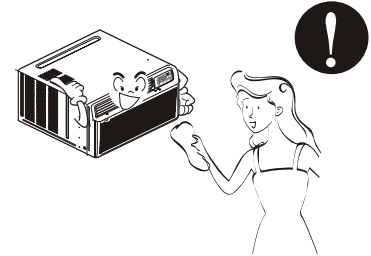

Do not step on the indoor/outdoor unit and do not put anything on it.

- It may cause an injury through dropping of the unit or falling down.

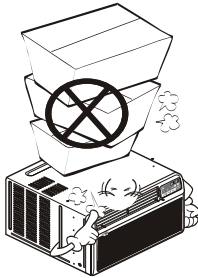

Always insert the filter securely. Clean it every two weeks.

- Operation without filters will cause failure.

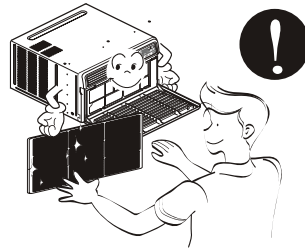

Do not drink water drained from air conditioner.

- It contains contaminants and will make you sick.

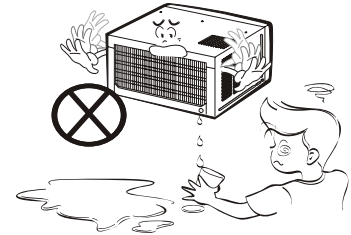

Be cautious not to touch the sharp edges when installing.

- It may cause injury.

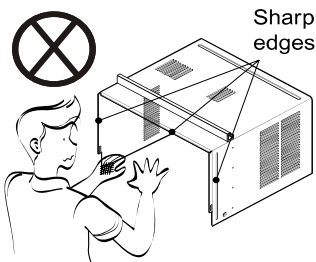

Avoid excessive cooling and perform ventilation sometimes.

- Otherwise, it may do harm to your health.

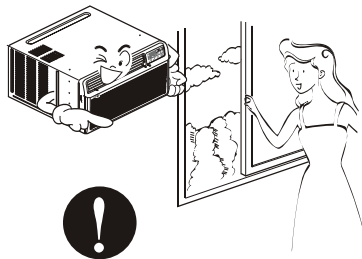

Do not insert the hands or bars through the air inlet or outlet during operation.

- Otherwise, it may cause personal injury.

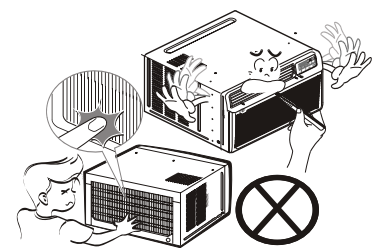

Before Operation

Preparing for Operation

1. Contact an installation specialist for installation.
2. Plug in the power plug properly.
3. Use a dedicated circuit.
4. Do not use an extension cord.
5. Do not start/stop operation by plugging/unplugging the power cord.
6. If the cord/plug is damaged, replace it with only an authorized replacement part.

Usage

1. Being exposed to direct airflow for an extended period of time could be hazardous to your health. Do not expose occupants, pets, or plants to direct airflow for extended periods of time.
2. Due to the possibility of oxygen deficiency, ventilate the room when used together with stoves or other heating devices.
3. Do not use this air conditioner for non-specified special purposes (e.g. preserving precision devices, food, pets, plants, and art objects). Such usage could damage the items.

Cleanin and Maintenance

1. Do not touch the metal parts of the unit when removing the filter. Injuries can occur when handling sharp metal edges.
2. Do not use water to clean inside the air conditioner. Exposure to water can destroy the insulation, leading to possible electric shock.
3. When cleaning the unit, first make sure that the power and breaker are turned off. The fan rotates at a very high speed during operation. There is a possibility of injury if the unit's power is accidentally triggered on while cleaning inner parts of the unit.

Service

For repair and maintenance, contact your authorized service dealer.

Introduction

Symbols Used in this Manual



This symbol alerts you to the risk of electric shock.



This symbol alerts you to hazards that could cause harm to the air conditioner.

NOTICE

This symbol indicates special notes.

Features

⚠ WARNING

This appliance should be installed in accordance with the National Electric Code.

NOTE: Your air conditioner may differ from the one shown.

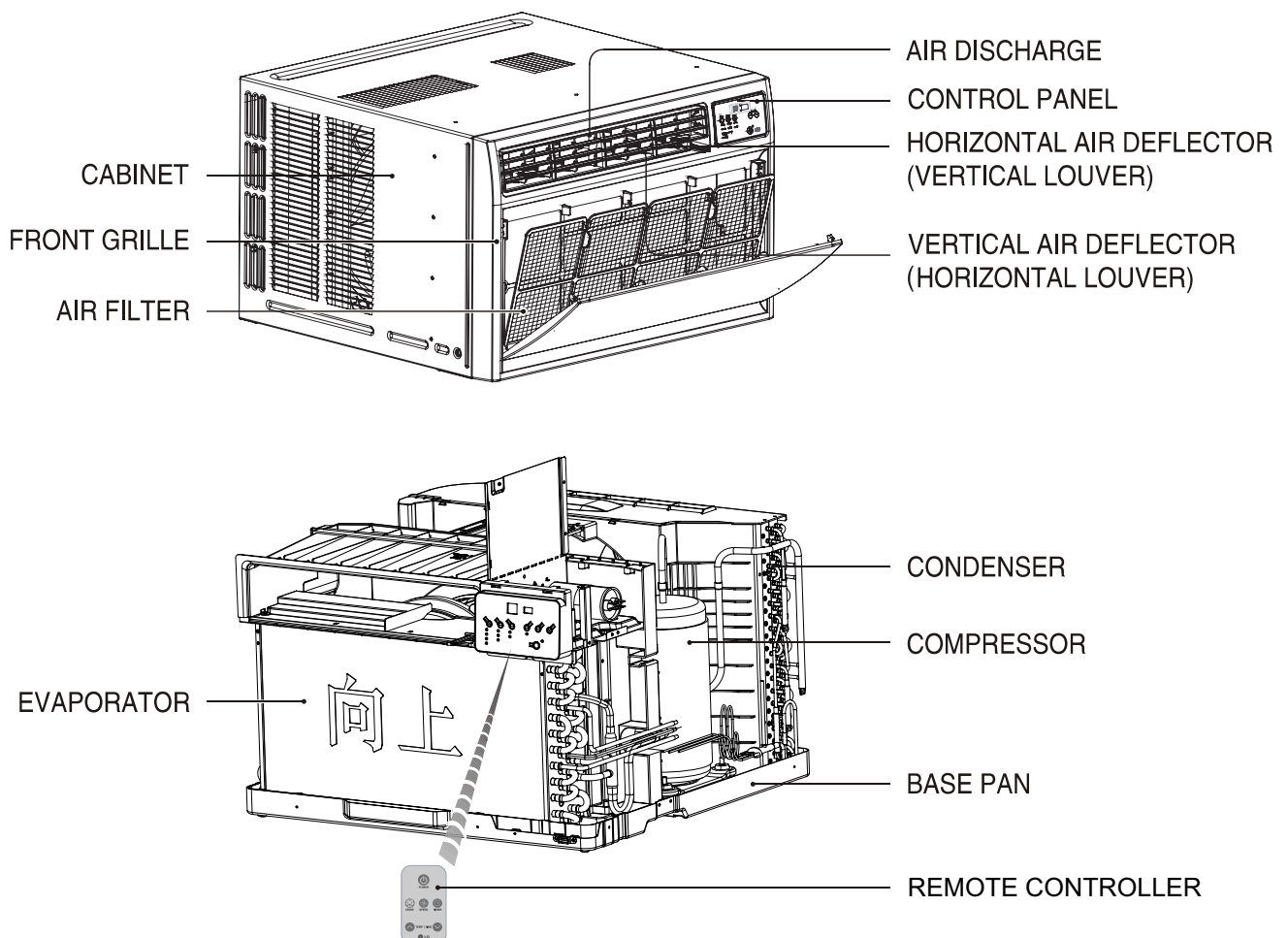

Electrical Safety

Electrical Data

115V~	230V~	
		<p>Power cord may include a current interrupter device. A test and reset button is provided on the plug case. The device should be tested on a periodic basis by first pressing the TEST button and then the RESET button. If the TEST button does not trip or if the RESET button will not stay engaged, discontinue use of the air conditioner and contact a qualified service technician.</p>

NOTICE

The shape may be different according to its model.

Use Wall Receptacle	Power Supply
<p>Standard 125V, 3-wire grounding receptacle rated 15A, 125V AC</p>	<p>Use 15 AMP. time delay fuse or 15 AMP. circuit breaker.</p>
<p>Standard 250V, 3-wire grounding receptacle rated 15A, 250V AC</p>	
<p>Standard 250V, 3-wire grounding receptacle rated 20A, 250V AC</p>	<p>Use 20 AMP. time delay fuse or 20 AMP. circuit breaker.</p>

Use of extension cords

Because of potential safety hazards, we strongly discourage the use of an extension cord. However, if you wish to use an extension cord, use a UL-listed 3-wire (grounding) extension cord, rated 15A, 125V.

All wiring should be made in accordance with local electrical codes and regulations.

NOTICE

Aluminum house wiring may pose special problems. Consult a qualified electrician.

ELECTRICAL SAFETY

IMPORTANT GROUNDING INSTRUCTIONS

Air conditioner has a three-prong grounding plug on its power supply cord, which must be plugged into properly grounded three-prong wall receptacle for your protection against possible shock hazard.

230, 208, and 230/208 VOLT UNITS

These units are equipped with a three-prong grounding plug on the power supply cord, which must be plugged into a matching properly grounded three-prong wall receptacle for your protection against possible shock hazard. If such an outlet is not present, one must be installed by a qualified electrician in accordance with the National Electrical Code and local codes and ordinances.

NOTICE

DO NOT USE AN EXTENSION CORD on 230, 208, and 230/208 Volt units.

Electrical Safety

⚡ WARNING: This appliance must be properly grounded.

The power cord of this appliance is equipped with a three-prong grounding plug. To minimize the risk of electric shock, use the plug with a standard three-slot grounding wall power outlet. If the power outlet does not include a grounding slot, have a qualified electrician replace the outlet before you use the room air conditioner.

⚡ WARNING: Changing the outlet without making the appropriate wiring changes will create an unsafe condition that could result in fire or electrical shock. Refer all such work to a licensed and qualified electrician.

⚡ WARNING: Do not cut or remove the grounding prong from the power plug.

⚡ WARNING: Attaching the adapter ground terminal to the wall receptacle cover screw does not ground the appliance unless the cover screw is metal and not insulated, and the wall receptacle is grounded through the house wiring.

⚡ WARNING: If you have any doubt whether the air conditioner is properly grounded, have the wall receptacle and circuit checked by a qualified electrician.

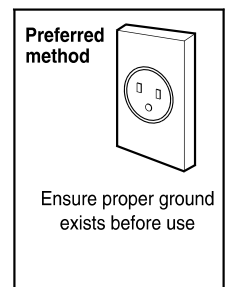

Temporary Use of an Adapter

We **strongly discourage** the use of an adapter due to potential safety hazards. For temporary connections, use only a UL-listed adapter, available from most local hardware stores. Ensure that the large slot in the adapter is aligned with the large slot in the receptacle for a proper polarity connection.

To disconnect the power cord from the adapter, use one hand on each to avoid damaging the ground terminal. Avoid frequently unplugging the power cord as this can lead to eventual ground terminal damage.

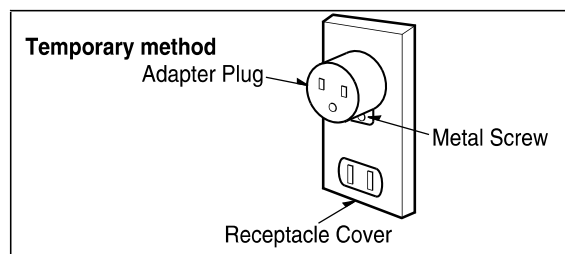

⚡ WARNING: Never use the appliance with a broken adapter.

Temporary Use of an Extension Cord

We **strongly discourage** the use of an extension cord due to potential safety hazards. For temporary situations, use only CSA certified and UL listed 3-wire grounded extension cords, rated 15 A, 125 V.

Installation

Installation Kits Contents

Parts supplied:

Check that all parts are included in parts package.

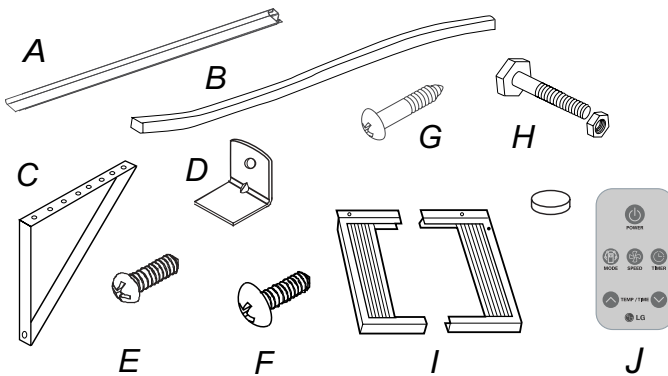

- A. Top rail
- B. Foam seal
- C. Installation brackets (left and right)
- D. Window lock bracket
- E. 14500-18000 BTU: $1\frac{3}{32}$ " screws (12)
24000 BTU: $1\frac{3}{32}$ " screws (10)
- F. $1\frac{3}{32}$ " bracket screws (6)
- G. 14500-18000 BTU: $3\frac{1}{32}$ " screws (8)
24000 BTU: $3\frac{1}{32}$ " screws (10)
- H. 2 1/2" Long flat head bolt and locknut(2)
- I. Left and right side curtains
- J. Remote control

Suggested Tool Requirements

Gather the required tools and parts before starting installation.
Read and follow the instructions provided with any tools listed here.

Tools needed

- Phillips head screwdriver
- Flat-blade screwdriver
- Scissors
- Level
- Tape measure
- Cordless drill and 1/8" bit
- Pencil
- Pliers
- Socket wrench and sockets
- Adjustable wrench

Location Requirements

IMPORTANT: Observe all governing codes and ordinances.

Check the location where the air conditioner will be installed.

Make sure you have everything necessary for correct installation.

The location should provide:

- Grounded electrical outlet within 4 ft (122 cm) of where the power cord exits the air conditioner.

NOTE: Do not use an extension cord.

- Free movement of air in room to be cooled.
- A large enough opening for the air conditioner. Installation parts are supplied for double-hung windows.
- Adequate wall support for weight of air conditioner. Air conditioner weighs 100 lbs to 130 lbs (45.4 kg to 59.0 kg).

NOTE: Cabinet louvers must not be obstructed. Air must be able to pass freely through the cabinet louvers.

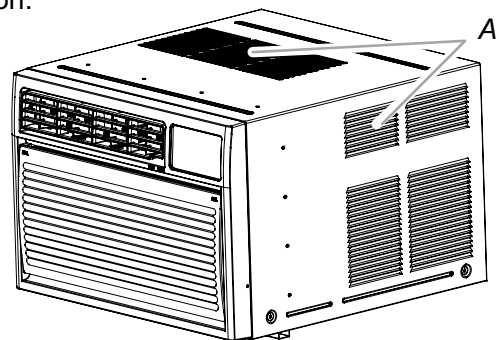

A. Cabinet louvers

Window Installation

Window opening measurements:

MODEL	14500-18000 BTU	24000 BTU
Dimension		
A(inch) Min	28 $\frac{3}{8}$ "(72.1cm)	31 $\frac{1}{4}$ "(79.4cm)
A(inch) Max	38"(96.5cm)	40"(101.6cm)
B(inch) Min	17 $\frac{3}{8}$ "(44.1cm)	20 $\frac{1}{4}$ "(51.4cm)

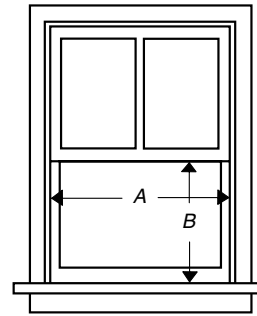

A. Width
B. Height



WARNING: This product is a WINDOW AIR CONDITIONER.
As such, a standard single-hung or double-hung window is required for proper installation. Non-window installations, including using sleeves, holes in walls, and other installations are not recommended.

Unpack the Air Conditioner

Remove Packaging Materials

- NOTE: The air conditioner must set upright for one hour before operating.
- Remove and dispose of/recycle packaging materials. Remove tape and glue residue from surfaces before turning on the air conditioner. Rub a small amount of liquid dish soap over the adhesive with your fingers. Wipe with warm water and dry.
- Do not use sharp instruments, rubbing alcohol, flammable fluids, or abrasive cleaners to remove tape or glue. These products can damage the surface of your air conditioner.
- Handle the air conditioner gently.

WARNING

Excessive Weight Hazard

Use two or more people to move and install air conditioner.

Failure to do so can result in back or other injury.

Prepare Air Conditioner for Installation

Unpack unit on the floor next to installation location.

- Remove two front attachment screws. Separate the outer case from the front with a putty knife at the catch points designated by the arrows.
- 14500-18000 BTU: Remove the four screws on both sides of the outer case.
24000 BTU: Remove the two screws on both sides of the outer case.
- Using the basepan handle, slowly and evenly pull chassis out from outer case.

NOTE: Cover putty knife blade with masking tape to guard against damage of the unit finish.

CAUTION: Never expose plastic front or grille to extreme temperatures.

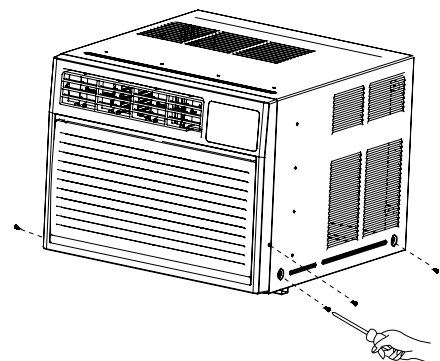

Assemble Curtain/Top Rail

NOTE: Attach curtains to the air conditioner before placing the air conditioner in window.

1. Install top rail with four 13/32" screws.
2. Slide left-hand curtain assembly into left end of top and bottom rails. Repeat for right-hand curtain assembly.
3. 14500-18000 BTU: Fasten curtain retainer strips to the sides of the outer case with eight 13/32" screws.
- 24000 BTU: Fasten curtain retainer strips to the sides of the outer case with six 13/32" screws.

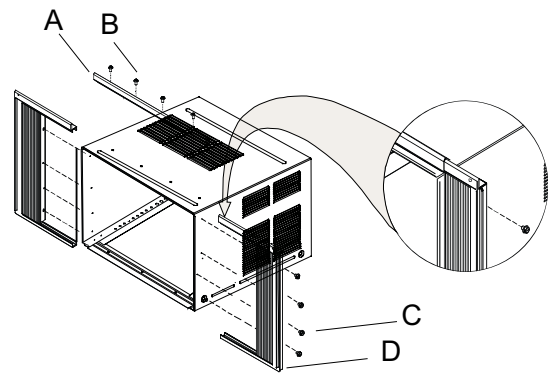

A. Top channel C. 13/32" screws
B. 13/32" screws D. Side curtains

Prepare the Window for Installation

1. Measure the width of the window opening.
2. Mark the center line on the inside windowsill.

- A. Width of window opening
B. Center line

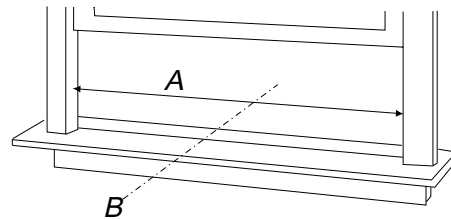

Positioning the Air Conditioner

Caution: During the following step, hold unit firmly until window sash is lowered to top channel behind side panel frames. Personal injury or property damage may result if unit falls from window.

WARNING

Excessive Weight Hazard

Use two or more people to move and install air conditioner.

Failure to do so can result in back or other injury.

NOTES:

- Handle the air conditioner gently.
- Be sure your air conditioner does not fall out of the opening during installation or removal.
- The place where the power cord exits the air conditioner should be no more than 4 ft (122 cm) from a grounded outlet.
- Do not block the louvers in the front panel.
- Do not block the louvers on the outside of the air conditioner.

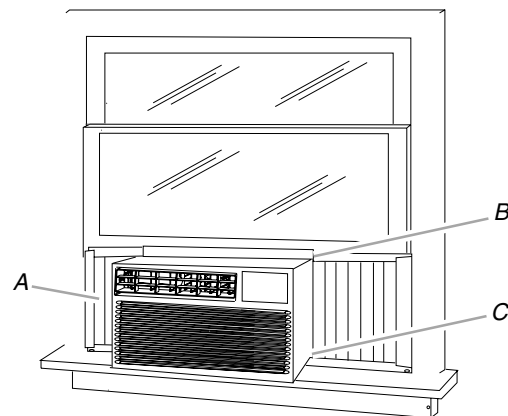

A. Side curtain against window channel
B. Window sash behind top channel
C. Bottom channel in behind windowsill

NOTE: Your model may differ from the one shown.

Install Outer Case in Window

1. Place outer case in window. Lower sash until it rests behind front flange of top rail. Bottom rail must rest behind window sill.

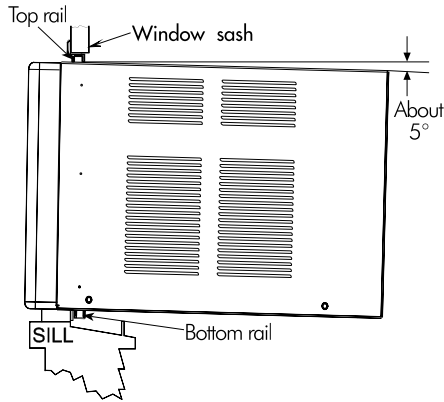

2. Expand both curtains to contact the window frame. Install four wood screws 3/32". Two in each upper right and left of the curtains.

3. 24000 BTU: Install three wood screws 3/32" in the top mounting channel.

3. 24000 BTU: Install three wood screws 3/32" in the top mounting channel.

4. Use three wood screw 3/32" to fix the case to windows sash.

14500-18000 BTU:

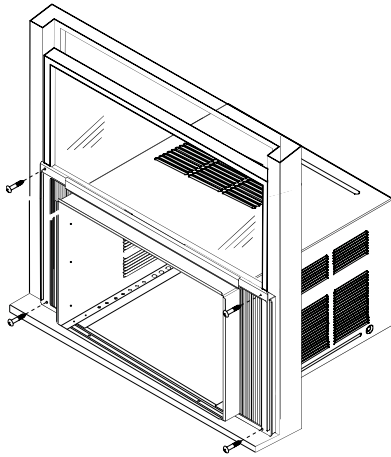

24000 BTU:

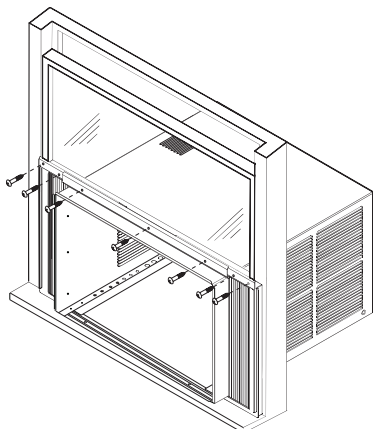

NOTE: To make screws easier to drive, drill a pilot hole into the sash through clearance hole in curtains.

NOTE: Tilt the outer case about 1/2" down towards the outside for proper condensate water drainage.

5. Install left&right installation bracket and as shown in fig. Install bolt (2-1/2" long flat head bolt and locknut) to the installation bracket and adjust them to proper length, then use 6 (13/32") screws to fix the bracket on the case.

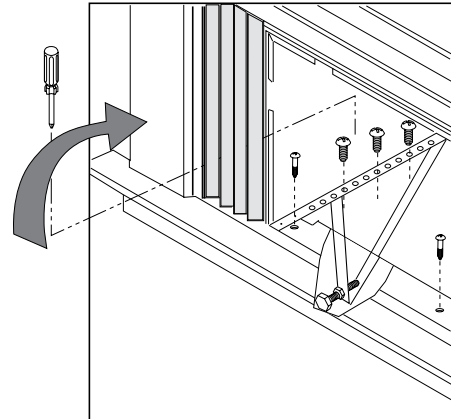

6. Use a wood block between the leveling bolts and the wall if the wall is weak or if the weight of the air conditioner falls between the studs in the wall.

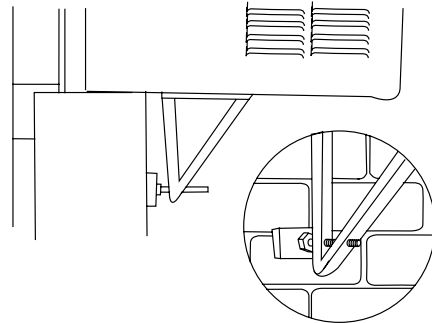

Completing the Installation

1. Insert the foam seal behind the top of the lower window sash and against the glass of the upper window.

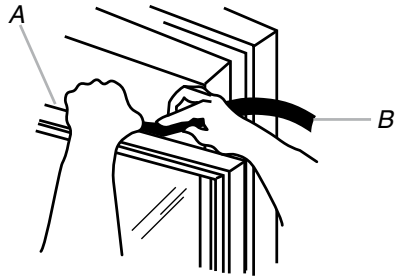

A. Top of lower window sash
B. Foam seal

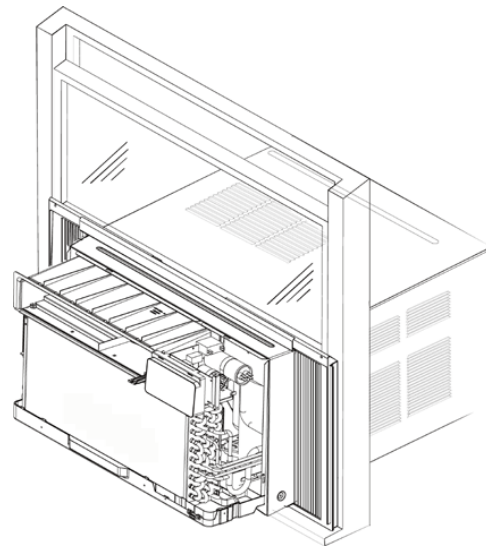

2. Place the window lock bracket as shown. Use a 1/8" drill bit to drill a starter hole through the hole in the window lock bracket and into the upper window.
3. Attach the window lock bracket to the upper window with one 31/32" screw to secure the window in place.

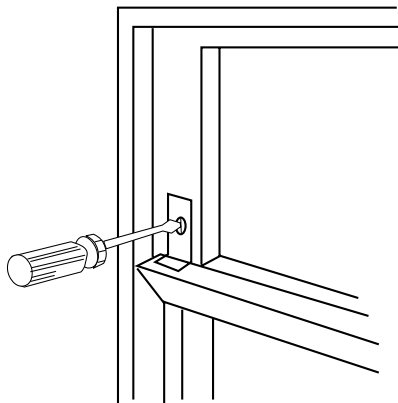

Note: For security purposes, reinstall screws at cabinet's sides, removed at the beginning.
IMPORTANT: Because the window sash helps keep the unit in window, make certain the window sash contacts the outer case before reinstalling the chassis.

⚠ WARNING

Electrical Shock Hazard

- Plug into a grounded 3 prong outlet.
- Do not remove ground prong.
- Do not use an adapter plug.
- Do not use an extension cord.

Failure to follow these instructions can result in death, fire, or electrical shock.

Return Chassis to the Outer Case

⚠ WARNING

Excessive Weight Hazard

Use two or more people to move and install air conditioner.
Failure to do so can result in back or other injury.

Find someone to help you replace the chassis in outer case. Replace front panel and grille.

1. Plug into a grounded 3 prong outlet.
2. Press RESET on the power supply cord. See "Electrical Requirements."

Operating Instructions

Remote Control Operations

ENGLISH

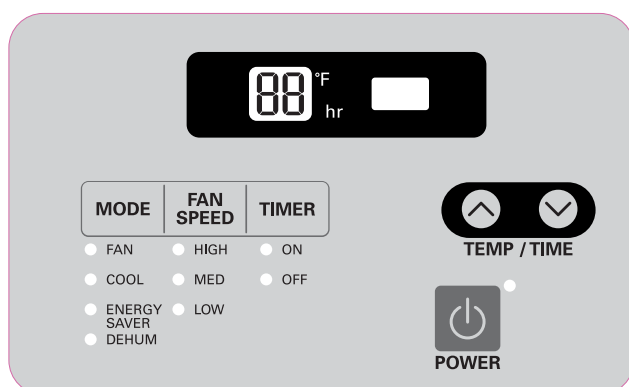

REMOTE CONTROLLER

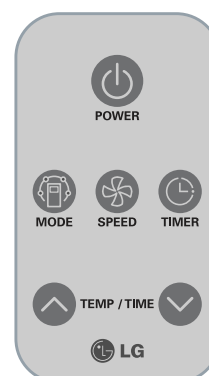

1 POWER

Operation starts when this button is pressed and stops when you press the button again.

2 FAN SPEED SELECTOR

For increased power while cooling, select a higher fan speed. 3 steps: High — Med — Low.

3 ON/OFF TIMER

- Press TIMER. Timer OFF indicator light will flash. Display will show remaining hours before the air conditioner will turn off.
- Press the TEMP/TIME up or down arrow button to change the delay time from 1 hour to 24 hours.
- After 5 seconds, Timer OFF indicator light will remain on. Display will show the current room temperature.

4 OPERATION MODE SELECTOR

- Press MODE until you see the indicator light glow for the desired setting.
- Choose Fan, Cool, Energy Saver or Dehum.
 - Fan—Only the fan runs. Press SPEED to select High, Med or Low fan speed. The display shows the current room temperature.
 - Cool—Cools the room. Press SPEED to select High, Med or Low fan speed. Press the TEMP/TIME up or down arrow button to adjust the temperature.
 - Energy Saver—Fan runs only when cooling is needed. Press SPEED to select High, Med or Low fan speed. Because the fan does not circulate the room air continuously, less energy is used, but the room air is not circulated as often.
 - Dehum—Dries the room. The air conditioner automatically selects the temperature. Fan runs on Low speed only.

5 TEMPERATURE CONTROL

- Press the TEMP/TIME up arrow button to raise the temperature. Each time you press or hold the TEMP/TIME up arrow button, the temperature will go up 1°F until it reaches 86°F (30°C).
- Press the TEMP/TIME down arrow button to lower the temperature. Each time you press or hold the TEMP/TIME down arrow button, the temperature will go down 1°F until it reaches 61°F (16°C).

6 REMOTE CONTROL SENSOR

AUTO RESTART

During operation in failure of electric power, the unit runs as previous setting operation.

⚠ CAUTION

The Remote Controller will not function properly if strong light strikes the sensor window of the air conditioner or if there are obstacles between the Remote Controller and the air conditioner.

NOTE: One CR2025 battery (included) powers the remote control. Replace battery after 6 months of use, or when the remote control starts to lose power.

Power

Press ON/OFF to turn on the air conditioner.

Mode

Press MODE to choose Fan, Cool, Energy saver or Dehum.

Speed

Press SPEED to choose High, Med or Low.

Temperature

- Press the TEMP/TIME up arrow button to raise the temperature. Each time you press or hold the TEMP/TIME up arrow button, the temperature will go up 1°F until it reaches 86°F (30°C).
- Press the TEMP/TIME down arrow button to lower the temperature. Each time you press or hold the TEMP/TIME down arrow button, the temperature will go down 1°F until it reaches 61°F (16°C).

Timer

To set the Timer for a 1-hour to 24-hour delay before the air conditioner is turned off (the air conditioner must be On):

1. Press TIMER. Timer OFF indicator light on the air conditioner control panel will flash.
2. Press the TEMP/TIME up or down arrow button to change the delay time from 1 hour to 24 hours.
3. After 5 seconds, Timer OFF indicator light on the air conditioner control panel will remain on.

To set Timer to turn on the air conditioner, keeping previous settings:

1. Turn on the air conditioner.

Press TIMER. Timer On indicator light on the air conditioner control panel will flash.

Press the TEMP/TIME up or down arrow button to change the delay time from 1 hour to 24 hours.

After 5 seconds, Timer On indicator light on the air conditioner control panel will remain on.

To set Timer to turn on the air conditioner, changing the previous settings:

1. Turn on the air conditioner.
2. Adjust the mode to Fan or Cool.
3. For Fan, Cool or Energy Saver mode, adjust the fan speed to High, Med or Low.
4. Adjust the temperature between 61°F and 86°F (16°C and 30°C).
NOTE: In Fan mode, the temperature cannot be set.
5. Press TIMER. Timer On indicator light on the air conditioner control panel will flash. Display will show remaining hours before the air conditioner will turn on.
6. Press the TEMP/TIME up or down arrow button to change the delay time from 1 hour to 24 hours.
7. Timer On indicator light on the air conditioner control panel will remain on.

To clear Timer delay program:

NOTE: Air conditioner can be either on or off.

1. Press TIMER once after it has been programmed. Display on the air conditioner control panel will show remaining time.
2. While the display is showing the remaining time, press TIMER until Timer indicator light turns off.

To see or change the remaining time (in hours):

Timer Off :

1. Press TEMP/TIME once after it has been programmed. Display on the air conditioner control panel will show remaining time.
2. While the display is showing the remaining time, press the TEMP/TIME up or down arrow button to increase or decrease the time.
3. After 5 seconds, the display on the air conditioner control panel will show the current room temperature.

Timer On :

1. Display on the air conditioner control panel will show remaining time.
2. While the display is showing the remaining time, press the TEMP/TIME up or down arrow button to increase or decrease the time.

Air Direction

Airflow can be adjusted by changing the direction of the air conditioner's louvers. This can also increase the cooling efficiency of the air conditioner.

4-Way Air Flow: The air directional louvers let you control the direction of the airflow to the desired direction. The airflow can be directed up-down, left-right.

Vent: The fresh air vent allows the air conditioner to recirculate inside air, draw fresh air into the room and exhaust stale air to the outside.

14500-18000 BTU:

24000 BTU:

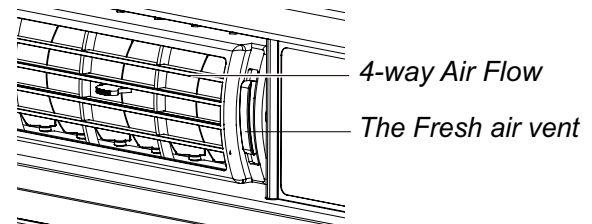
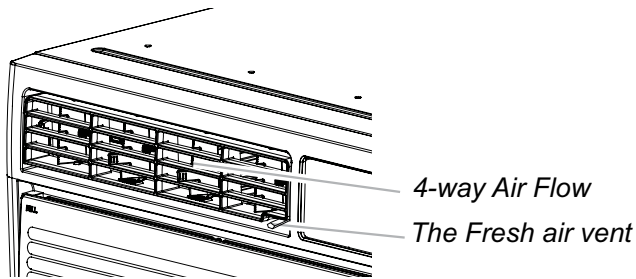

Normal Sounds

When your air conditioner is operating normally, you may hear sounds such as:

- Droplets of water hitting the condenser, causing a pinging or clicking sound. The water droplets help cool the condenser.
- Air movement from the fan.
- Clicks from the thermostat cycle.
- Vibrations or noise due to poor wall or window construction.
- A high-pitched hum or pulsating noise caused by the modern high-efficiency compressor cycling on and off.

Maintenance and Service

Turn the power off and unplug the power plug before cleaning the air conditioner.

Air Filter

Your new air conditioner is designed to give you many years of dependable service. This section tells you how to clean and care for your air conditioner properly.

Cleaning the Air Filter

The air filter is removable for easy cleaning. A clean filter helps remove dust, lint, and other particles from the air and is important for best cooling and operating efficiency. Check the filter every 2 weeks to see whether it needs cleaning.

Note: Do not operate the air conditioner without the filter in place.

1. Turn off the air conditioner.
2. Remove the air filter by opening the front panel and removing the air filter.
3. Use a vacuum cleaner to clean air filter. If the air filter is very dirty, wash it in warm water with a mild detergent. Do not wash the air filter in the dishwasher or use any chemical cleaners. Air dry the air filter completely before replacing to ensure maximum efficiency.
4. Replace the air filter.
5. Close the front panel.
6. Turn on the air conditioner.

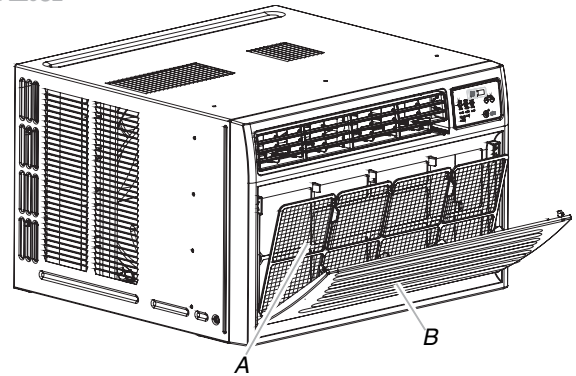

A. Air filter
B. Front panel

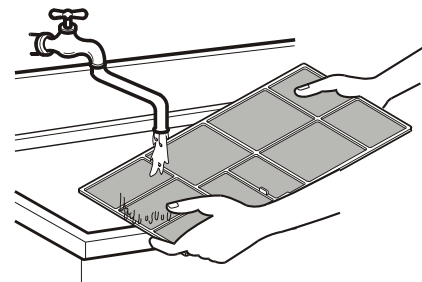

Cleaning the Front Panel

1. Turn off the air conditioner.
2. Clean the front panel with a soft, damp cloth.
3. Air dry the front panel completely.
4. Turn on the air conditioner.

Annual Maintenance

Your air conditioner needs annual maintenance to help ensure steady, top performance throughout the year. Call your local authorized dealer to schedule an annual checkup. The expense of an annual inspection is your responsibility.

Common Problems and Solutions

Before calling for service, please review the following list of common problems and solutions.

The air conditioner is operating normally when:

- You hear a pinging noise. This is caused by water being picked up by the condenser on rainy days or in highly humid conditions. This feature is designed to help remove moisture in the air and improve cooling efficiency.
- You hear the thermostat click. This is caused by the compressor cycle starting and stopping.
- You see water dripping from the rear of the unit. Water may be collected in the base pan in highly humid conditions or on rainy days. This water overflows and drips from the rear of the unit.
- You hear the fan running while the compressor is silent. This is a normal operational feature.

The air conditioner may be operating abnormally when:

<i>Problem</i>	<i>Possible Causes</i>	<i>What To Do</i>
The air conditioner does not operate at all	■ The air conditioner is unplugged or not plugged in completely	• Make sure the plug is completely plugged into the outlet
	■ The fuse is blown/circuit breaker is triggered	• Check the fuse/circuit breaker box and replace the fuse or reset the breaker
	■ Power failure.	• In the event of a power failure, set the power control to OFF. When the power is restored, wait 3 minutes to restart the air conditioner to prevent the compressor from overloading
	■ The current interrupter device is tripped.	• Press the RESET button located on the power cord plug. If the RESET button will not stay engaged, discontinue use of the air conditioner and contact a qualified service technician.
Air conditioner does not cool	■ Air flow is restricted	• Make sure there are no curtains, blinds, furniture or other obstacles in front of the air conditioner
	■ The THERMOSTAT may not be set cool enough	• Turn the knob to a higher setting. The highest setting provides maximum cooling
	■ The air filter is dirty.	• Clean the filter at least every 2 weeks. Refer to the "Maintenance and Service" section of the manual.
	■ The air conditioner was just turned on.	• After the air conditioner is turned on, you need to give the air conditioner some time to cool the room.
	■ Cold air is escaping.	• Check for open furnace floor registers and cold air returns. • CLOSE the air conditioner vent
Ice appears on the air conditioner.	■ Cooling coils are iced up	• See Ice appears on the air conditioner below
	■ The cooling coils are iced over.	• Ice may block the air flow and obstruct the air conditioner from properly cooling the room. Set the fan at MED or HIGH while setting the thermostat at 1 or 2 until the ice melts.



LG ELECTRONICS, INC.
1000 Sylvan Ave., Englewood Cliffs, NJ 07632

LG Customer Information Center

1-800-243-0000

Register your product Online!

www.lgappliances.com