

This Owner's Manual is provided and hosted by [Appliance Factory Parts](#).

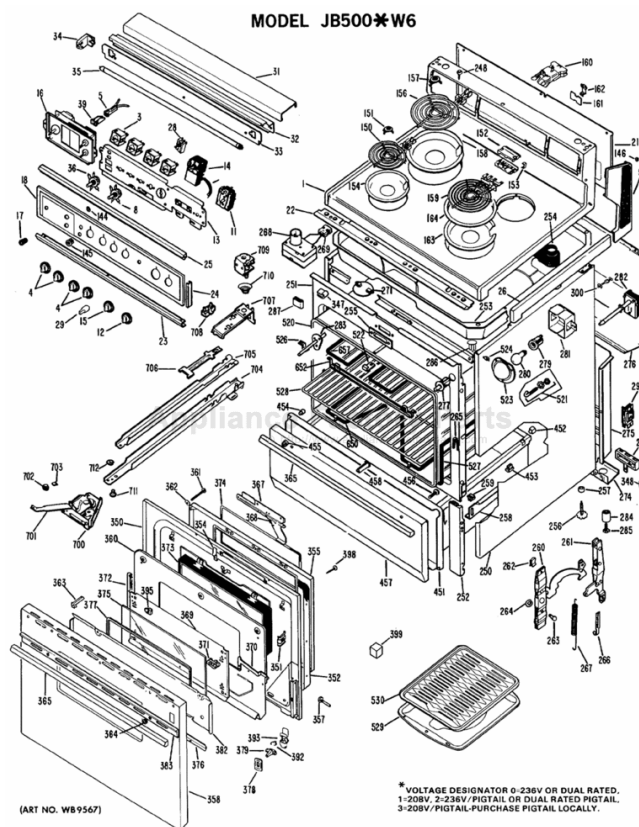

# GE JB500\*W6 Owner's Manual

[Shop genuine replacement parts for GE JB500\\*W6](#)



[Find Your GE Electric Range Parts - Select From 348 Models](#)

----- Manual continues below -----



# Self-Cleaning Radiant Ranges

*Safety Instructions* ..... 2-6

***Operating Instructions***

Clock and Timer ..... 13  
Oven ..... 10-18  
    Sabbath Feature ..... 15  
    Self-Cleaning ..... 17, 18  
    Thermostat ..... 16  
    Timed Baking & Roasting ... 14  
Surface Units ..... 7-9

***Care and Cleaning***

Broiler Pan & Grid ..... 22  
Control Knobs ..... 19  
Glass Cooktop ..... 23, 24  
Lift-Off Oven Door ..... 20  
Light ..... 22  
Shelves ..... 21

***Troubleshooting Tips*** ... 25-28

***Consumer Support***

Consumer Support .. Back Cover  
Product Registration ..... 29, 30  
Warranty ..... 31

**Owner's Manual**

- EER2000
- EER3000
- EER3001
- EER3002
- JB500
- JB600
- JB700
- JBP64
- JBP65
- JBP66
- JBP67
- JBP68
- JBP69
- JBP70
- JBP78

**Write the model and serial numbers here:**

**Model #** \_\_\_\_\_

**Serial #** \_\_\_\_\_

You can find them on a label behind the storage drawer on the front of the range frame.



## **IMPORTANT SAFETY INFORMATION. READ ALL INSTRUCTIONS BEFORE USING.**

### **⚠ WARNING!**

*For your safety, the information in this manual must be followed to minimize the risk of fire, electric shock, or to prevent property damage, personal injury, or loss of life.*



### **⚠ WARNING ANTI-TIP DEVICE**

**All ranges can tip and injury could result.**

*To prevent accidental tipping of the range, attach it to the wall and floor by installing the Anti-Tip device supplied.*



*To check if the device is installed and engaged properly, remove the kick panel or storage drawer and inspect the rear leveling leg. Make sure it fits securely into the slot.*



If you pull the range out from the wall for any reason, make sure the device is properly engaged when you push the range back against the wall. If it is not, there is a possible risk of the range tipping over and causing injury if you or a child stand, sit or lean on an open door.

Please refer to the Anti-Tip device information in this manual. Failure to take this precaution could result in tipping of the range and injury.



## IMPORTANT SAFETY NOTICE

*The California Safe Drinking Water and Toxic Enforcement Act requires the Governor of California to publish a list of substances known to the state to cause cancer, birth defects or other reproductive harm, and requires businesses to warn customers of potential exposure to such substances.*

*The fiberglass insulation in self-clean ovens gives off a very small amount of carbon monoxide during the cleaning cycle. Exposure can be minimized by venting with an open window or using a ventilation fan or hood.*

*Fluorescent light bulbs contain mercury. If your model has a surface light, you must recycle the fluorescent light bulb according to local, state and federal codes.*



## SAFETY PRECAUTIONS

*When using electrical appliances, basic safety precautions should be followed, including the following:*

- Use this appliance only for its intended purpose as described in this Owner's Manual.
- Be sure your appliance is properly installed and grounded by a qualified installer in accordance with the provided installation instructions.
- Have the installer show you the location of the circuit breaker or fuse. Mark it for easy reference.
- Do not attempt to repair or replace any part of your range unless it is specifically recommended in this manual. All other servicing should be referred to a qualified technician.
- Before performing any service, disconnect the range power supply at the household distribution panel by removing the fuse or switching off the circuit breaker.
- Do not leave children alone—children should not be left alone or unattended in an area where an appliance is in use. They should never be allowed to sit or stand on any part of the appliance.
- Do not allow anyone to climb, stand or hang on the door, storage drawer or cooktop. They could damage the range and even tip it over, causing severe personal injury.

## IMPORTANT SAFETY INFORMATION. READ ALL INSTRUCTIONS BEFORE USING.

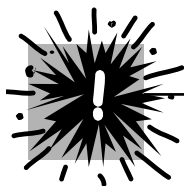

### ⚠ **WARNING!** SAFETY PRECAUTIONS

*Do not operate the oven or cooktop controls if the glass is broken. Food splatter or cleaning solution may penetrate a broken control panel and create a risk of electrical shock. Contact a qualified technician immediately should your glass control panel become broken.*

- Do not store flammable materials in an oven or near the cooktop.
  - **CAUTION:** Items of interest to children should not be stored in cabinets above a range or on the backsplash of a range—children climbing on the range to reach items could be seriously injured.
  - Never wear loose-fitting or hanging garments while using the appliance. Be careful when reaching for items stored over the range. Flammable material could be ignited if brought in contact with hot surface units or heating elements and may cause severe burns.
  - Use only dry pot holders—moist or damp pot holders on hot surfaces may result in burns from steam. Do not let pot holders touch hot surface units or heating elements. Do not use a towel or other bulky cloth in place of pot holders.
  - Do not use water on grease fires. Never pick up a flaming pan. Turn the controls off. Smother a flaming pan on a surface unit by covering the pan completely with a well-fitting lid, cookie sheet or flat tray. Use a multi-purpose dry chemical or foam-type fire extinguisher.
- Flaming grease outside a pan can be put out by covering it with baking soda or, if available, by using a multi-purpose dry chemical or foam-type fire extinguisher.
- Flame in the oven can be smothered completely by closing the oven door and turning the oven off or by using a multi-purpose dry chemical or foam-type fire extinguisher.
- For your safety, never use your appliance for warming or heating the room.
  - Do not let cooking grease or other flammable materials accumulate in or near the range.
  - Do not touch the surface units, the heating elements or the interior surface of the oven. These surfaces may be hot enough to burn even though they are dark in color. During and after use, do not touch, or let clothing or other flammable materials contact the surface units, areas nearby the surface units or any interior area of the oven; allow sufficient time for cooling first.
- Potentially hot surfaces include the cooktop, areas facing the cooktop, oven vent opening, surfaces near the opening, crevices around the oven door.
- REMEMBER:** The inside surface of the oven may be hot when the door is opened.
- Do not store or use combustible materials, gasoline or other flammable vapors and liquids in the vicinity of this or any other appliance.
  - Keep the hood and grease filters clean to maintain good venting and to avoid grease fires.
  - Teach children not to play with the controls or any other part of the range.
  - Always keep dish towels, dish cloths, pot holders and other linens a safe distance from your range.
  - Always keep wooden and plastic utensils and canned food a safe distance from your range.
  - Always keep combustible wall coverings, curtains or drapes a safe distance from your range.



### COOK MEAT AND POULTRY THOROUGHLY...

*Cook meat and poultry thoroughly—meat to at least an INTERNAL temperature of 160°F. and poultry to at least an INTERNAL temperature of 180°F. Cooking to these temperatures usually protects against foodborne illness.*



## RADIANT SURFACE UNITS

Use proper pan size—select cookware having flat bottoms large enough to cover the surface unit heating element. The use of undersized cookware will expose a portion of the surface unit to direct contact and may result in ignition of clothing. Proper relationship of cookware to surface unit will also improve efficiency.

- Never leave the surface units unattended at high heat settings. Boilovers cause smoking and greasy spillovers that may catch on fire.
  - Only certain types of glass, glass/ceramic, earthenware or other glazed containers are suitable for cooktop service; others may break because of the sudden change in temperature.
  - To minimize the possibility of burns, ignition of flammable materials and spillage, the handle of a container should be turned toward the center of the range without extending over nearby surface units.
  - Always turn the surface units off before removing cookware.
  - When preparing flaming foods under the hood, turn the fan on.
  - Use care when touching the cooktop. The glass surface of the cooktop will retain heat after the controls have been turned off.
  - Keep an eye on foods being fried at high or medium high heat settings.
  - Foods for frying should be as dry as possible. Frost on frozen foods or moisture on fresh foods can cause hot fat to bubble up and over the sides of the pan.
  - Use little fat for effective shallow or deep fat frying. Filling the pan too full of fat can cause spillovers when food is added.
  - If a combination of oils or fats will be used in frying, stir together before heating, or as fats melt slowly.
  - Always heat fat slowly, and watch as it heats.
  - Use a deep fat thermometer whenever possible to prevent overheating fat beyond the smoking point.
  - Avoid scratching the glass cooktop. The cooktop can be scratched with items such as sharp instruments, rings or other jewelry, and rivets on clothing.
  - Do not operate the radiant surface units if the glass is broken. Spillovers or cleaning solution may penetrate a broken cooktop and create a risk of electrical shock. Contact a qualified technician immediately should your glass cooktop become broken.
  - Never use the glass cooktop surface as a cutting board.
  - Do not place or store items that can melt or catch fire on the glass cooktop, even when it is not being used.
  - Be careful when placing spoons or other stirring utensils on glass cooktop surface when it is in use. They may become hot and could cause burns.
  - Clean the cooktop with caution. If a wet sponge or cloth is used to wipe spills on a hot surface unit, be careful to avoid steam burns. Some cleaners can produce noxious fumes if applied to a hot surface.
- NOTE:** We recommend that you avoid wiping any surface unit areas until they have cooled and the indicator light has gone off. Sugar spills are the exception to this. Please see the *Cleaning the glass cooktop* section.
- When the cooktop is cool, use only the recommended cleaning cream to clean the cooktop.
  - To avoid possible damage to the cooking surface, do not apply cleaning cream to the glass surface when it is hot.
  - After cleaning, use a dry cloth or paper towel to remove all cleaning cream residue.
  - Read and follow all instructions and warnings on the cleaning cream labels.
  - Large scratches or impacts to glass doors or cooktops can lead to broken or shattered glass.

## IMPORTANT SAFETY INFORMATION. READ ALL INSTRUCTIONS BEFORE USING.



### **⚠ WARNING!** OVEN

*Stand away from the range when opening the oven door. Hot air or steam which escapes can cause burns to hands, face and/or eyes.*

- Do not heat unopened food containers. Pressure could build up and the container could burst, causing an injury.
- Keep the oven vent unobstructed.
- Keep the oven free from grease buildup.
- Place the oven shelf in the desired position while the oven is cool. If shelves must be handled when hot, do not let pot holder contact the heating elements.
- When using cooking or roasting bags in the oven, follow the manufacturer's directions.
- Pulling out the shelf to the stop-lock is a convenience in lifting heavy foods. It is also a precaution against burns from touching hot surfaces of the door or oven walls.
- Do not use the oven to dry newspapers. If overheated, they can catch on fire.
- Do not use the oven for a storage area. Items stored in an oven can ignite.
- Do not leave paper products, cooking utensils or food in the oven when not in use.
- Do not use aluminum foil to line oven bottoms, except as suggested in this manual. Improper installation of aluminum foil may result in a risk of electric shock or fire.



### SELF-CLEANING OVEN

*Do not use oven cleaners. No commercial oven cleaner or oven liner protective coating of any kind should be used in or around any part of the oven. Residue from oven cleaners will damage the inside of the oven when the self-clean cycle is used.*

- Do not clean the door gasket. The door gasket is essential for a good seal. Care should be taken not to rub, damage or move the gasket.
- Before self-cleaning the oven, remove the broiler pan, grid and other cookware.
- Be sure to wipe up excess spillage before starting the self-cleaning operation.
- If the self-cleaning mode malfunctions, turn the oven off and disconnect the power supply. Have it serviced by a qualified technician.
- Clean only parts listed in this Owner's Manual.



*READ AND FOLLOW THIS SAFETY INFORMATION CAREFULLY.*  
**SAVE THESE INSTRUCTIONS**

Throughout this manual, features and appearance may vary from your model.

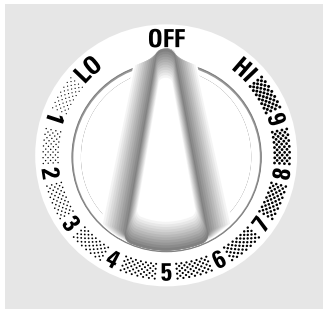

At both **OFF** and **HI** the control **clicks** into position. You may hear slight **clicking** sounds during cooking, indicating the control is maintaining your desired setting.  
Be sure you turn the control knob to **OFF** when you finish cooking.

### How to Set

Push the knob in and turn in either direction to the setting you want.

A **HOT COOKTOP** indicator light will glow when any radiant element is turned on, and will remain on until the surface is cooled to approximately 150°F.

### Indicator light will:

- come on when the unit is hot to the touch.
- stay on even after the unit is turned off.
- glow until the unit is cooled to approximately 150°F.

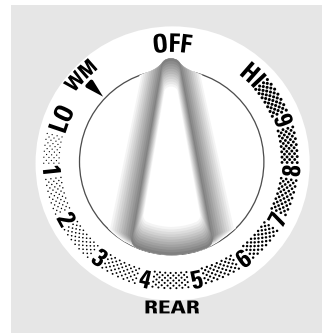

The **WM** (warm) setting (on some models) on the right **REAR** surface unit keeps already heated food warm until ready to serve.

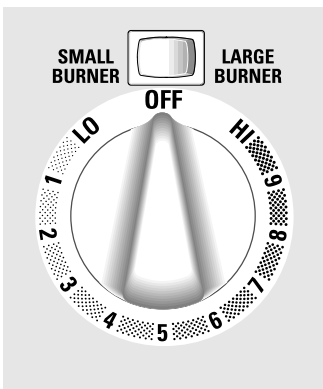

### Dual Surface Unit Control Knob (on some models)

The dual surface unit has 2 cooking sizes to select from so you can match the size of the unit to the size of the cookware you are using.

To use the small (5 or 6 inch) surface unit, push in the **SMALL BURNER** portion of the switch above the control knob.

To use the large (8 or 9 inch) surface unit, push in the **LARGE BURNER** portion of the switch above the control knob.

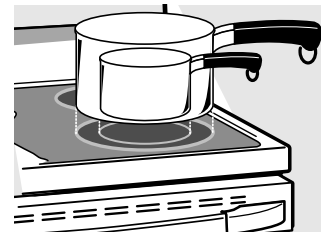

### Using the Warming Zone (on some models)

The **WARMING ZONE**, located in the back center of the glass surface, will keep hot, cooked food at serving temperature. Always start with hot food. Do not use to heat cold food. Placing uncooked or cold food on the **WARMING ZONE** could result in food-borne illness.

Push and turn the control knob to any desired setting.

For best results, all foods on the **WARMING ZONE** should be covered with a lid or aluminum foil. When warming pastries or breads, the cover should be vented to allow moisture to escape.

Always use potholders or oven mitts when removing food from the **WARMING ZONE**, as cookware and plates will be hot.

**CAUTION:** Do not warm food on the **WARMING ZONE** for more than two hours.

**NOTE:** The surface warmer will not glow red like the cooking elements.

A **HOT** surface indicator light will glow when the glass surface is hot and will remain on until the surface is cool enough to touch. Lower settings may not heat the glass surface enough to cause the **HOT** surface indicator light to come on.

A **WARMING ZONE** indicator light will glow when the unit is on.

- Do not use plastic wrap to cover food. Plastic may melt onto the surface and be very difficult to clean.
- Use only cookware recommended for top-of-range cooking.

### WARMER GUIDE

SETTING	FOOD
(Low)	Bread/Pastries
(Medium)	Chocolate/Butter
(Medium)	Sauces, Stews, Cream Soups
(Medium)	Vegetables
(High)	Soups (liquid)
(High)	Tea or Coffee

The Warmer Guide is for reference only and the **SETTING** that you need will depend on the amount and type of food, the starting temperature of the food, and the length of the holding time.

## Using the surface units.

Throughout this manual, features and appearance may vary from your model.



Never cook directly on the glass. Always use cookware.



Always place the pan in the center of the surface unit you are cooking on.



### About the radiant surface units...

The radiant cooktop features heating units beneath a smooth glass surface.

**NOTE:** A slight odor is normal when a new cooktop is used for the first time. It is caused by the heating of new parts and insulating materials and will disappear in a short time.

**NOTE:** On models with light colored glass cooktops, it is normal for the cooking zones to change color when hot or cooling down. This is temporary and will disappear as the glass cools to room temperature.

The surface unit will cycle on and off to maintain your selected control setting.

It is safe to place hot cookware on the glass surface even when the cooktop is cool.

Do not slide cookware across the cooktop because it can scratch the glass—the glass is scratch resistant, not scratch proof.

Even after the surface units are turned off, the glass cooktop retains enough heat to continue cooking. To avoid over-cooking, remove pans from the surface units when the food is cooked. Avoid placing anything on the surface unit until it has cooled completely.

- Water stains (mineral deposits) are removable using the cleaning cream or full strength white vinegar.
- Use of window cleaner may leave an iridescent film on the cooktop. The cleaning cream will remove this discoloration.
- Don't store heavy items above the cooktop. If they drop onto the cooktop, they can cause damage.
- Do not use the surface as a cutting board.

### Temperature Limiter

Every radiant surface unit has a temperature limiter.

The temperature limiter protects the glass cooktop from getting too hot.

The temperature limiter may cycle the units off for a time if:

- The pan boils dry.
- The pan bottom is not flat.
- The pan is off center.
- There is no pan on the unit.

# Selecting types of cookware.

The following information will help you choose cookware which will give good performance on glass cooktops.

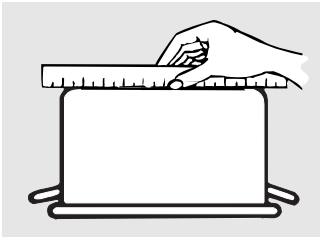

Check pans for flat bottoms by using a straight edge.

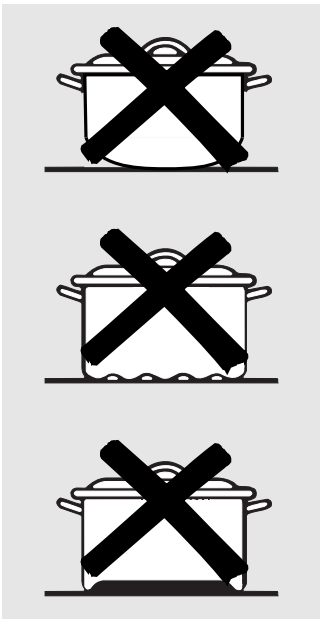

Pans with rounded, curved, ridged or warped bottoms are not recommended.

## **Stainless Steel:**

*recommended*

## **Aluminum:**

*heavy weight recommended*

Good conductivity. Aluminum residues sometimes appear as scratches on the cooktop, but can be removed if cleaned immediately. Because of its low melting point, thin weight aluminum should not be used.

## **Copper Bottom:**

*recommended*

Copper may leave residues which can appear as scratches. The residues can be removed, as long as the cooktop is cleaned immediately. However, do not let these pots boil dry. Overheated metal can bond to glass cooktops. An overheated copper bottom pot will leave a residue that will permanently stain the cooktop if not removed immediately.

## **Porcelain Enamel Covered Cast Iron:**

*recommended*

As long as the cookware is covered completely with porcelain enamel, this cookware is recommended. Caution is recommended for cast iron cookware that is not completely covered with smooth porcelain enamel, as it may scratch the glass ceramic cooktop.

## **Glass-ceramic:**

*usable, but not recommended*

Poor performance. May scratch the surface.

## **Stoneware:**

*usable, but not recommended*

Poor performance. May scratch the surface.

## **Home Canning Tips:**

Be sure the canner is centered over the surface unit.

Make sure the canner is flat on the bottom.

Use recipes and procedures from reputable sources. These are available from manufacturers such as Ball® and Kerr® and the Department of Agriculture Extension Service.

To prevent burns from steam or heat, use caution when canning.

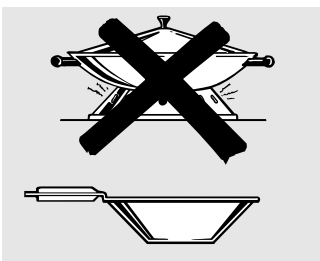

Use only flat-bottomed woks.

## **Wok Cooking**

We recommend that you use only a flat-bottomed wok. They are available at your local retail store.

Do not use woks that have support rings.

Do not use round bottom woks. You could be seriously burned if the wok tipped over.

## Using the oven controls.

Throughout this manual, features and appearance may vary from your model.

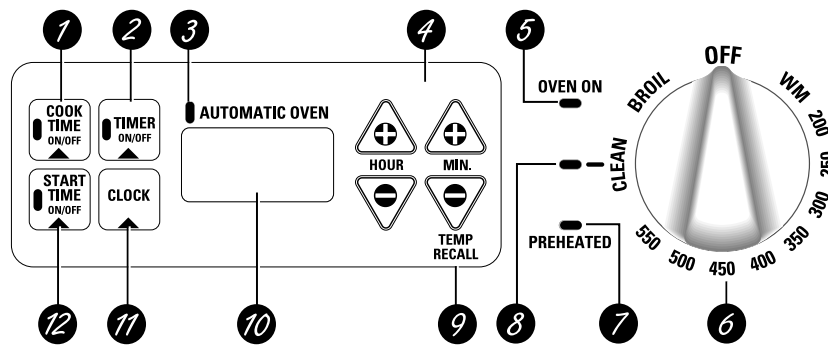

### Oven Control, Clock and Timer Features and Settings

- 1 COOK TIME ON/OFF Pad**  
Press this pad and then press the **HOUR** and **MIN.** pads to set the amount of time you want your food to cook. Turn the Oven Temperature knob to the desired temperature. The oven will shut off when the Cook Time has run out.
- 2 TIMER ON/OFF Pad**  
Press this pad to select the timer feature.
- 3 AUTOMATIC OVEN Light**  
This lights anytime the oven has been programmed to automatically turn on or off.
- 4 HOUR and MIN. Pads**  
These pads allow you to set times up to 11 hours and 59 minutes.

*As a safety feature, this oven will automatically shut off after 12 hours. On models with touch pad clock controls this feature may be deactivated to allow the oven to be left on for more than 12 hours. **To deactivate or reactivate the Automatic Oven Shut-Off, press and hold both the MIN. +/- pads for about 4 seconds.***

- 5 OVEN ON Light**  
Glow anytime the oven is heating. The light will flash when the oven automatically turns off to remind you to turn the Oven Temperature knob to **OFF**.
- 6 Oven Temperature Knob**  
Turn this knob to the setting you want. (On some models, you must push the knob in before turning.) The temperature will be displayed to indicate setting. Display will change back to time after a few seconds.
- 7 PREHEATED Light**  
Glow when the oven reaches your selected temperature.
- 8 CLEAN Light**  
Glow when the oven is in the self-clean cycle. After the self-clean cycle, the light will flash. Unlatch the door and turn the Oven Temperature knob to **OFF**.
- 9 TEMP RECALL**  
Press the – pad above **TEMP RECALL** to display the selected oven temperature.
- 10 Display**  
Shows the time of day and the time set for the timer.
- 11 CLOCK Pad**  
Press this pad before setting the clock.
- 12 START TIME ON/OFF Pad**  
Press this pad and the **HOUR** and **MIN.** pads to delay the starting of your oven up to 11 hours and 59 minutes.

*On some models, opening the oven door will not automatically turn the oven light on. You may use the oven light switch to turn the light on and off.*

*Do not lock the oven door with the latch during cooking. The latch is used for self-cleaning only.*

*If “F— and a number or letter” flash in the display and the oven control signals, this indicates a function error code.*

*If your oven was set for a timed oven operation and a power outage occurred, the clock and all programmed functions must be reset.*

*The time of day will flash in the display when there has been a power outage.*

# Using the oven.

To avoid possible burns, place the shelves in the desired position before you turn the oven on.

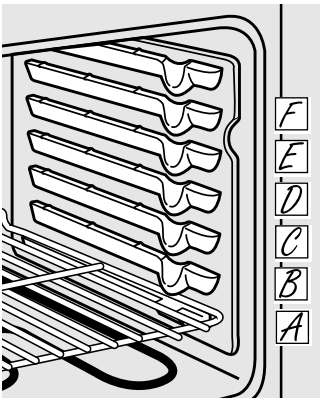

The oven has 6 shelf positions.

## Before you begin...

The shelves have stops, so that when placed correctly on the supports, they will stop before coming completely out, and will not tilt.

When placing and removing cookware, pull the shelf out until it stops.

**To remove a shelf**, pull it toward you, tilt the front end up and pull it out.

**To replace**, place the end of the shelf (stop-locks) on the support, tilt up the front and push the shelf in.

**CAUTION:** When you are using the shelf in the lowest position (A), you will need to use caution when pulling the shelf out. We recommend that you pull the shelf out several inches and then, using two pot holders, pull the shelf out by holding the sides of it. The shelf is low and you could be burned if you place your hand in the middle of the shelf and pull all the way out. Be very careful not to burn your hand on the door when using the shelf in the lowest position (A).

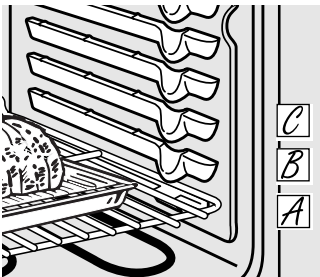

## How to Set the Oven for Baking or Roasting

- 1 Turn the Oven Temperature knob to the temperature you desire.  
On some models, you must push the knob in before turning.
- 2 Check food for doneness at minimum time on recipe. Cook longer if necessary.
- 3 Turn the Oven Temperature knob to **OFF** when cooking is complete.

Type of Food	Shelf Position
Frozen pies (on cookie sheet)	D
Angel food cake	A
Bundt or pound cakes	C or D
Biscuits, muffins, brownies, cookies, cupcakes, layer cakes, pies	C or D
Casseroles	C or D
Turkey	A

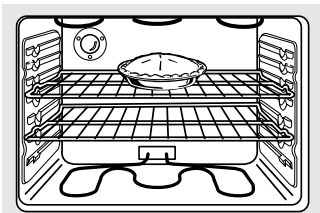

Center baking pans in the oven

## Preheating and Pan Placement

Preheat the oven if the recipe calls for it. Preheating is necessary for good results when baking cakes, cookies, pastry and breads.

To preheat, set the oven at the correct temperature. The control will beep when the oven is preheated and the display will show your set temperature. This will take approximately 6–10 minutes.

Baking results will be better if baking pans are centered in the oven as much as possible. If baking with more than one pan, place the pans so each has at least 1 to 1½" of air space around it. If baking four cake layers at the same time, place two layers on rack B and two layers on rack D. Stagger the pans on the rack so one is not directly above the other.

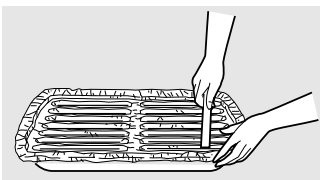

Cut slits in the foil just like the grid.

## Aluminum Foil

You can use aluminum foil to line the broiler pan and broiler grid. However, you must mold the foil tightly to the grid and cut slits in it just like the grid.

Without the slits, the foil will prevent fat and meat juices from draining into the broiler pan. The juices could become hot enough to catch on fire. If you do not cut the slits, you are essentially frying, not broiling.

Do not use aluminum foil on the bottom of the oven.

Never entirely cover a shelf with aluminum foil. This will disturb the heat circulation and result in poor baking.

A smaller sheet of foil may be used to catch a spillover by placing it on a lower shelf several inches below the food.

## Using the oven.

To avoid possible burns, place the shelves in the desired position before you turn the oven on.

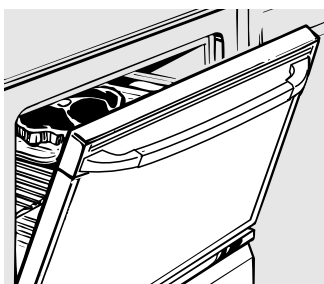

Leave the door open to the broil stop position. The door stays open by itself, yet the proper temperature is maintained in the oven.

### How to Set the Oven for Broiling

- 1 Place the meat or fish on the broiler grid in the broiler pan.
- 2 Follow suggested shelf positions in the *Broiling Guide*.
- 3 Turn the Oven Temperature knob to **BROIL**.  
On some models, you must push the knob in before turning.
- 4 When broiling is finished, turn the Oven Temperature knob to **OFF**.

If your range is connected to 208 volts, rare steaks may be broiled by preheating the broiler and positioning the oven shelf one position higher.

Use **LO Broil** to cook foods such as poultry or thick cuts of meat thoroughly without over-browning them.

### Broiling Guide

The size, weight, thickness, starting temperature, and your preference of doneness will affect broiling times. This guide is based on meats at refrigerator temperature.

† The U.S. Department of Agriculture says "Rare beef is popular, but you should know that cooking it to only 140°F. means some food poisoning organisms may survive." (Source: *Safe Food Book, Your Kitchen Guide*. USDA Rev. June 1985.)

Food	Quantity and/or Thickness	Shelf Position	First Side Time (min.)	Second Side Time (min.)	Comments
<b>Ground Beef</b>	1 lb. (4 patties) 1/2 to 3/4" thick	D	13	8	Space evenly.
	4 lbs. (12 patties)	D	15	11	
<b>Beef Steaks</b>	Rare†	F	6	4	Steaks less than 3/4" thick are difficult to cook rare. Slash fat.
	Medium	E	8	6	
	Well Done	E	10	8	
Rare†	1 1/2" thick 2 to 2 1/2 lbs.	D	10	8	
		D	15	10-12	
		E	20	20	
<b>Chicken</b>	1 whole cut up 2 to 2 1/2 lbs., split lengthwise	C	25	25	Brush each side with melted butter. Broil skin-side-down first.
	Breast	C	25	15	
<b>Bakery Product</b>	Bread (toast)	E	3	1	Space evenly. Place English muffins cut-side-up and brush with butter if desired.
	English Muffin	F	3-4		
<b>Lobster Tails</b>	2-4	C	18-20	Do not turn over.	Cut through back of shell. Spread open. Brush with melted butter before broiling and after half of broiling time.
<b>Fish Fillets</b>	1 lb. (1/4 to 1/2" thick)	E	5	5	Handle and turn very carefully. Brush with lemon butter before and during cooking, if desired.
<b>Salmon</b>	Steaks 2 (1" thick) Fillets 2 (1/2 to 3/4" thick)	E	10	5	Turn carefully. Do not turn skin side down.
		E	10		
<b>Ham Slices</b> (precooked)	1/2" thick 1" thick	D	6	6	
		D	8	8	
<b>Pork Chops</b>	2 (1/2" thick) Well Done 2 (1" thick) about 1 lb.	D	10	10	Slash fat.
		D	15	15	
<b>Lamb Chops</b>	Medium Well Done Medium Well Done	E	7	4	Slash fat.
		E	10	9	
		E	9	6	
		E	14	10	

# Using the clock and timer.

Not all features are on all models.



Make sure the clock is set to the correct time of day.

## To Set the Clock

The clock must be set to the correct time of day for the automatic oven timing functions to work properly. The time of day cannot be changed during a timed baking or self-cleaning cycle.

- 1 Press the **CLOCK** pad.
- 2 Press the **HOUR** and **MIN.** pads until the time of day shows in the display.

## To Black-Out the Clock

If you have several clocks in your kitchen, you may wish to black-out the time of day display of your range. If so, press the **CLOCK** pad.

Press the **CLOCK** pad twice to retain the time of day after a black-out.

Although you cannot see it, the clock maintains the correct time of day. It will reappear for the duration of any function that displays a Start Time or Cook Time. Press the **CLOCK** pad again to bring back the display.



The timer is a minute timer only.

The timer does not control oven operations.

The maximum setting on the timer is 11 hours and 59 minutes.

## To Set the Timer

- 1 Press the **TIMER ON/OFF** pad.

- 2 Press the **HOUR** and **MIN.** pads until the amount of time you want shows in the display. The timer will start automatically within a few seconds of releasing the pad.

## To Reset the Timer

If the display is still showing the time remaining, you may change it by pressing the **HOUR** and **MIN.** pads until the time you want appears in the display.

If the remaining time is not in the display, recall the remaining time by pressing the **TIMER ON/OFF** pad and then pressing the **HOUR** and **MIN.** pads until the new time you want shows in the display.

## To Cancel the Timer

Press the **TIMER ON/OFF** pad twice.

## End of Cycle Tones

Clear the tones by pressing the pad of the function you are using.

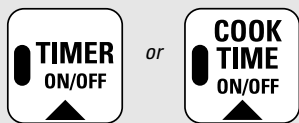

## Using the timed baking and roasting features.

Do not latch the oven door during timed cooking. The latch is used for self-cleaning only.

**NOTE:** Foods that spoil easily—such as milk, eggs, fish, stuffings, poultry and pork—should not be allowed to sit for more than 1 hour before or after cooking. Room temperature promotes the growth of harmful bacteria. Be sure that the oven light is off because heat from the bulb will speed harmful bacteria growth.

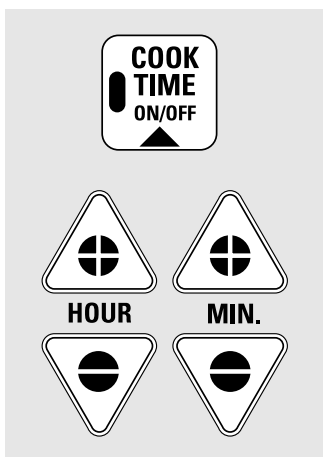

### How to Set an Immediate Start and Automatic Stop

The oven will turn on immediately and cook for a selected length of time. At the end of the cooking time the oven will turn off automatically.

- 1 Press the **COOK TIME ON/OFF** pad.
- 2 Using the **HOUR** and **MIN.** pads, enter the length of cooking time.
- 3 Turn the Oven Temperature knob to the desired temperature.

On some models, you must push the knob in before turning.

The display will show the cooking time remaining. When the oven reaches the set temperature, a tone sounds.

When the oven automatically turns off the **AUTOMATIC OVEN** light will flash and the oven will signal. Turn the oven control to **OFF** to stop the flashes and signal.

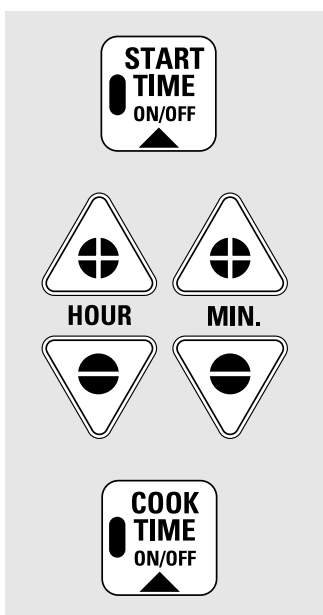

### How to Set a Delayed Start and Automatic Stop

You can set the oven control to delay-start the oven, cook for a specific length of time and then turn off automatically.

Make sure the clock shows the correct time of day.

- 1 Press the **START TIME ON/OFF** pad.
- 2 Using the **HOUR** and **MIN.** pads, enter the time you want cooking to start.
- 3 Press the **COOK TIME ON/OFF** pad.
- 4 Using the **HOUR** and **MIN.** pads, enter the length of cooking time.
- 5 Turn the Oven Temperature knob to the desired temperature.

On some models, you must push the knob in before turning.

When the oven automatically turns off the **AUTOMATIC OVEN** light will flash and the oven will signal. Turn the oven control to **OFF** to stop the flashes and signal.

# Using the Sabbath Feature.

(Designed for use on the Jewish Sabbath and Holidays) (On some models)

GEAppliances.com

The Sabbath feature can be used for baking/roasting only. It cannot be used for broiling, self-cleaning, or Delay Start cooking.

**NOTE:** The oven light comes on automatically (on some models) when the door is opened and goes off when the door is closed. The bulb may be removed. See the Oven Light Replacement section. On models with a light switch on the control panel, the oven light may be turned on and left on.



## How to Set for Regular Baking/Roasting

Make sure the clock shows the correct time of day and the oven is off.

- 1 Press and hold **both** the **MIN. + AND -** pads, **at the same time**, until the display changes.
- 2 Press and hold **either** the **MIN. + OR -** pad until the display changes, then release the pad. If **SAb** appears in the display, go to the next step. If **SAb** is not in the display, continue to press, hold and release the pad until **SAb** appears.
- 3 Turn the Oven Temperature knob to the desired temperature between

warm (**WM**) and 550°. The display will show  $\supset$ .

After a random delay period of approximately 30 seconds to 1 minute,  $\supset$   $\subset$  will appear in the display indicating that the oven is baking or roasting. If  $\supset$   $\subset$  does not appear in the display, reset the temperature.

To adjust the oven temperature, turn the Oven Temperature knob to the desired temperature.

**NOTE:** The **COOK TIME ON/OFF** pad is active during the Sabbath feature.

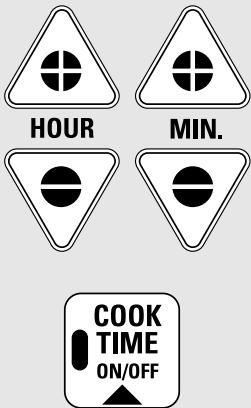

## How to Set for Timed Baking/Roasting - Immediate Start and Automatic Stop

Make sure the clock shows the correct time of day and the oven is off.

- 1 Press and hold **both** the **MIN. + AND -** pads, **at the same time**, until the display changes.
- 2 Press and hold **either** the **MIN. + OR -** pad until the display changes, then release the pad. If **SAb** appears in the display, go to the next step. If **SAb** is not in the display, continue to press, hold and release the pad until **SAb** appears.
- 3 Press the **COOK TIME ON/OFF** pad.
- 4 Immediately enter the length of cooking time, using the **HOUR** and **MIN.** pads. The cooking time that you entered will be displayed.

- 5 Turn the Oven Temperature knob to the desired temperature. The display will show  $\supset$ .

After a random delay period of approximately 30 seconds to 1 minute,  $\supset$   $\subset$  will appear in the display indicating that the oven is baking or roasting. If  $\supset$   $\subset$  does not appear in the display, reset the temperature.

To adjust the oven temperature, turn the Oven Temperature knob to the desired temperature.

When cooking is finished, the display will change from  $\supset$   $\subset$  to  $\supset$ , indicating that the oven has turned **OFF** but is still set in Sabbath. Remove the cooked food.



## How to Exit the Sabbath Feature

- 1 Turn the Oven Temperature knob to **OFF**.  
If the oven is cooking, wait for a random time delay of approximately 30 seconds to 1 minute until only  $\supset$  is in the display.
- 2 Press and hold **both** the **MIN. + AND -** pads, **at the same time**, until the display changes.
- 3 Press and hold **either** the **MIN. + OR -** pad until the display changes, then release the pad. Continue to press, hold and release the pad until **ON** or **OFF**

appears for your preference of 12 hour automatic oven shut-off. **ON** indicates that the 12 hour automatic oven shut-off is turned on and **OFF** indicates that the 12 hour automatic oven shut-off is turned off.

- 4 Press the **CLOCK** pad to return to the time of day.

**NOTE:** If a power outage occurred when the oven was in Sabbath mode, the oven will automatically turn off and the oven control must be reset.

## Adjust the oven thermostat—Do it yourself!

You may find that your new oven cooks differently than the one it replaced. Use your new oven for a few weeks to become more familiar with it. If you still think your new oven is too hot or too cold, you can adjust the thermostat yourself.

Do not use thermometers, such as those found in grocery stores, to check the temperature setting of your oven. These thermometers may vary 20–40°F.



### To Adjust the Thermostat

- 1 Put the Oven Temperature knob in the **OFF** position.
- 2 Press and hold the **HOUR +/-** pads for 5 seconds until the display changes.
- 3 Before display changes back, press the **HOUR +/-** pads to increase or decrease the temperature in 5 degree increments.

The oven temperature can be adjusted up as much as 35°F. or down as much as 35°F.

If the oven adjustment is set cooler than the factory setting a minus sign (–) and the adjusted temperature will appear in the display.

- 4 Wait several seconds for the control to automatically set and return to its previous setting.

**NOTE:** This adjustment will not affect the broiling or the self-cleaning temperatures. The adjustment will be retained after a power failure.

## The type of margarine will affect baking performance!

Most recipes for baking have been developed using high fat products such as butter or margarine (80% fat). If you decrease the fat, the recipe may not give the same results as with a higher fat product.

Recipe failure can result if cakes, pies, pastries, cookies or candies are made with low fat spreads. The lower the fat content of a spread product, the more noticeable these differences become.

Federal standards require products labeled “margarine” to contain at least 80% fat by weight. Low fat spreads, on the other hand, contain less fat and more water. The high moisture content of these spreads affects the texture and flavor of baked goods. For best results with your old favorite recipes, use margarine, butter or stick spreads containing at least 70% vegetable oil.

# Using the self-cleaning oven.

Never force the latch handle. Forcing the handle will damage the door lock mechanism.

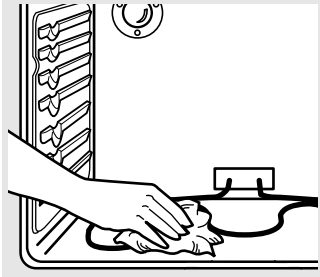

Wipe up heavy soil on the oven bottom.

## Before a Clean Cycle

We recommend venting your kitchen with an open window or using a ventilation fan or hood during the first self-clean cycle.

Remove the shelves, broiler pan, broiler grid, all cookware and any aluminum foil from the oven.

The oven shelves can be self-cleaned, but they will darken, lose their luster and become hard to slide.

Soil on the front frame of the range and outside the gasket on the door will need to be cleaned by hand. Clean these areas with hot water, soap-filled steel-wool pads or cleansers such as Soft Scrub®. Rinse well with clean water and dry.

Do not clean the gasket. The fiberglass material of the oven door gasket cannot withstand abrasion. It is essential for the gasket to remain intact. If you notice it becoming worn or frayed, replace it.

Wipe up any heavy spillovers on the oven bottom.

Make sure the oven light bulb cover is in place and the oven light is off.

**IMPORTANT:** The health of some birds is extremely sensitive to the fumes given off during the self-cleaning cycle of any range. Move birds to another well ventilated room.

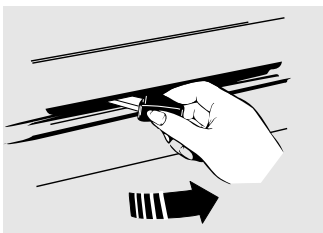

## How to Set the Oven for Cleaning

- 1 Latch the door.
- 2 Turn the Oven Temperature knob to **CLEAN**.

On some models, you must push the knob in before turning.

Clean cycle time is normally 4 hours and 20 minutes. On models with **COOK TIME** and **START TIME** pads, you can change the clean time to between 3 hours and 5 hours, 59 minutes by using the **HOUR** and **MIN.** pads. The display will show the clean time counting down.

When the **CLEAN** light flashes, slide the latch handle to the left, and turn the Oven Temperature knob to **OFF**.

**To stop a clean cycle,** turn the Oven Temperature knob to **OFF**. Wait until the oven has cooled and unlatch the door.

■ While the oven is self-cleaning, you can press the **CLOCK** pad to display the time of day. To return to the clean countdown, press the **COOK TIME ON/OFF** pad.

## Using the self-cleaning oven.

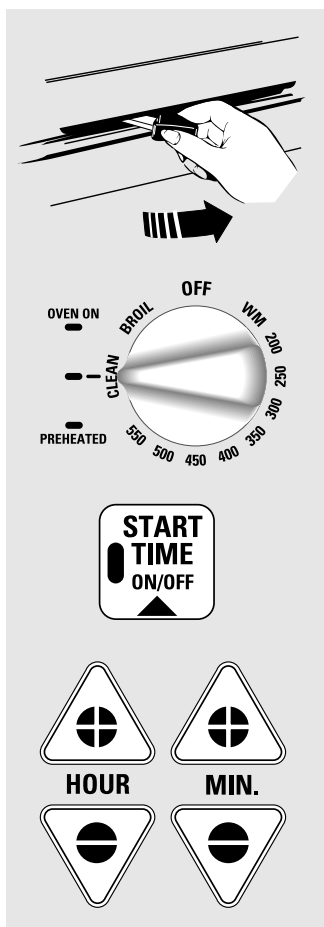

### How to Delay the Start of Cleaning

Make sure the clock shows the correct time of day.

- 1 Latch the door.
- 2 Turn the Oven Temperature knob to **CLEAN**.  
On some models, you must push the knob in before turning.
- 3 Press the **START TIME ON/OFF** pad.
- 4 Press the **HOUR** and **MIN.** pads to set the time cleaning will start.

When the **CLEAN** light flashes, slide the latch handle to the left as far as it will go and turn the Oven Temperature knob to **OFF**.

### After a Clean Cycle

You may notice some white ash in the oven. Wipe it up with a damp cloth after the oven cools.

*If white spots remain, remove them with a soap-filled steel wool pad and rinse thoroughly with a vinegar and water mixture.*

These deposits are usually a salt residue that cannot be removed by the clean cycle.

If the oven is not clean after one clean cycle, repeat the cycle.

- You cannot set the oven for cooking until the oven is cool enough for the door to be unlatched.
- If the shelves become hard to slide, apply a small amount of vegetable oil or cooking oil to a paper towel and wipe the edges of the oven shelves with the paper towel.

# Care and cleaning of the range.

GEAppliances.com

Be sure all controls are off and all surfaces are cool before cleaning any part of the range.

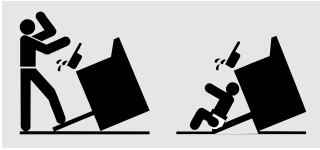

If your range is removed for cleaning, servicing or any reason, be sure the anti-tip device is re-engaged properly when the range is replaced. Failure to take this precaution could result in tipping of the range and cause injury.

## How to Remove Packaging Tape

To assure no damage is done to the finish of the product, the safest way to remove the adhesive left from packaging tape on new appliances is an application of a household liquid dishwashing detergent, mineral oil or cooking oil.

Apply with a soft cloth and allow to soak. Wipe dry and then apply an appliance polish to thoroughly clean and protect the surface.

**NOTE:** The plastic tape (on some models) must be removed from all chrome trim. It cannot be removed if it is baked on.

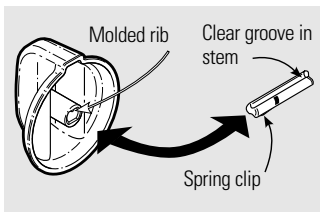

## Control Knobs

### To Remove:

- 1 Be sure the knob is in the **OFF** position.
- 2 Pull straight off the stem. Using a piece of string can make removing the knob easier. Slip the string under and around the knob, pull straight out.

Wash the knob thoroughly with warm soapy water. Dry completely with a soft cloth. **DO NOT** let the knob soak.

### To Replace:

- 1 Check the back of the knob.
- 2 The molded rib of the knob is designed to fit perfectly onto the knob stem.
- 3 Align the molded rib to the clear groove in the knob stem. Push the knob back as far as it will go.

## Control Panel

- Clean up splatters with a damp cloth.
- You may also use a glass cleaner.
- Remove heavier soil with warm soapy water.
- Do not use abrasives of any kind.

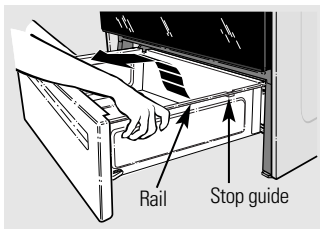

## Storage Drawer Removal

### To remove the drawer:

- 1 Pull the drawer out until it stops.
- 2 Lift the front of the drawer until the stops clear the guides.
- 3 Remove the drawer.

### To replace the drawer:

- 1 Place the drawer rails on the guides.
- 2 Push the drawer back until it stops.
- 3 Lift the front of the drawer and push back until the stops clear the guides.
- 4 Lower the front of the drawer and push back until it closes.

## Care and cleaning of the range.

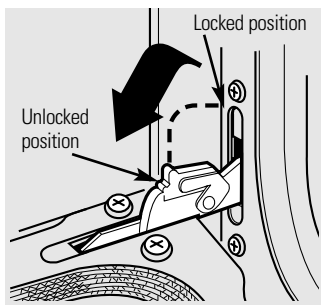

Pull the hinge locks down to the unlocked position.

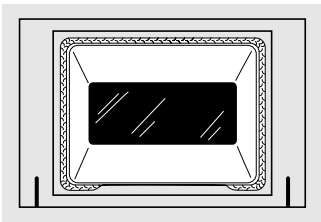

The gasket is designed with a gap at the bottom to allow for proper air circulation.

Do not rub or clean the door gasket—it has an extremely low resistance to abrasion.

If you notice the gasket becoming worn, frayed or damaged in any way or if it has become displaced on the door, you should have it replaced.

### Lift-Off Oven Door

The oven door is removable for easier access to the light bulb.

Do not lift the door by the handle.

#### To remove the door:

- 1 Fully open the door.
- 2 Each hinge has a hinge lock. Using a tool, pull the hinge locks down against the door frame.
- 3 Firmly grasp the door **at the top sides**.
- 4 Close the door to the stop position.
- 5 Lift the door up and pull straight out.

#### To replace the door:

- 1 Firmly grasp the door **at the top sides. This is critical.**
- 2 Approach the range with the door angled in a vertical position.

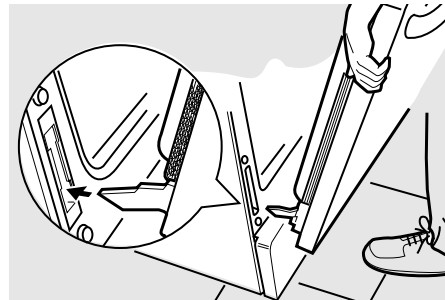

- 3 Guide the hinges into the slots.
- 4 Push door in firmly while opening.
- 5 Once in position, open the door completely. Push the hinge locks back in towards the front frame.

#### To clean the inside of the door:

- Because the area inside the gasket is cleaned during the self-clean cycle, you do not need to clean this by hand.
- The area outside the gasket and the door liner can be cleaned with a soap-filled steel wool or plastic pad, hot water and detergent. Rinse well with a vinegar and water solution.

#### To clean the outside of the door:

- Use soap and water to thoroughly clean the top, sides and front of the oven door. Rinse well. You may also use a glass cleaner to clean the glass on the outside of the door. Do not let water drip into the vent openings.
- If any stain on the door vent trim is persistent, use a soft abrasive cleaner and a sponge-scrubber for best results.
- Spillage of marinades, fruit juices, tomato sauces and basting materials containing acids may cause discoloration and should be wiped up immediately. When surface is cool, clean and rinse.
- Do not use oven cleaners, cleaning powders or harsh abrasives on the outside of the door.

### Painted Surfaces

Painted surfaces include the sides, top of backguard and the drawer front.

Clean these with soap and water or a vinegar and water solution.

Do not use commercial oven cleaners, cleaning powders, steel wool or harsh abrasives on any painted surface.

### Oven Vent

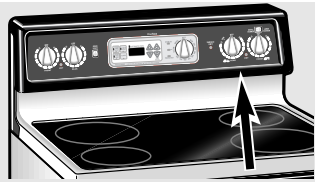

The oven vent is located behind the right rear surface unit.

This area could become hot during oven use.

It is normal for steam to come out of the vent and moisture may collect underneath it when the oven is in use.

The vent is important for proper air circulation. Never block this vent.

### Oven Shelves

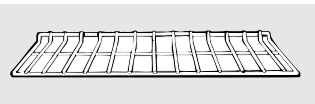

Clean the oven shelves with an abrasive cleanser or steel wool. After cleaning, rinse the shelves with clean water and dry with a clean cloth.

**NOTE:** The oven shelves may be cleaned in the self-cleaning oven. However, the shelves will darken in color, lose their luster and become hard to slide if cleaned during the self-cleaning cycle.

To make the shelves slide more easily apply a small amount of vegetable oil or cooking oil to a paper towel and wipe the edges of the oven shelves with the paper towel.

## Care and cleaning of the range.

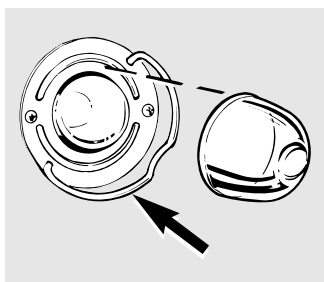

Wire cover holder.

### Oven Light Replacement

**CAUTION:** Before replacing your oven light bulb, disconnect the electrical power to the range at the main fuse or circuit breaker panel.

Be sure to let the light cover and bulb cool completely.

#### To remove the cover:

- 1 Hold a hand under the cover so it doesn't fall when released. With fingers of the same hand, firmly push back the wire cover holder. Lift off the cover.

*Do not remove any screws to remove the cover.*

- 2 Replace bulb with a 40-watt appliance bulb.

#### To replace the cover:

- 1 Place it into groove of the light receptacle. Pull wire forward to the center of the cover until it snaps into place.
- 2 Connect electrical power to the range.

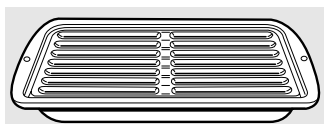

After broiling, remove the broiler pan from the oven.

### Broiler Pan & Grid

*Do not clean the broiler pan or grid in a self-cleaning oven.*

After broiling, remove the broiler pan from the oven. Remove the grid from the pan. Carefully pour out the grease from the pan into a proper container.

Wash and rinse the broiler pan and grid in hot water with a soap-filled or plastic scouring pad.

If food has burned on, sprinkle the grid with detergent while hot and cover with wet paper towels or a dishcloth. Soaking the pan will remove burned-on foods.

Both the broiler pan and grid may be cleaned with a commercial oven cleaner.

Both the broiler pan and grid can also be cleaned in a dishwasher.

*Do not store a soiled broiler pan and grid anywhere in the range.*

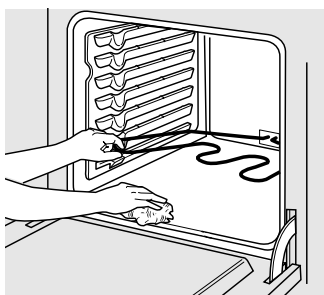

### Oven Heating Elements

*Do not clean the bake element or the broil element. Any soil will burn off when the elements are heated.*

To clean the oven floor, gently lift the bake element. Clean with warm soapy water.



**Clean your cooktop after each spill.**

## Normal Daily Use Cleaning

**ONLY** use the recommended cleaning cream, Cerama Bryte®, on the glass cooktop. Other creams may not be as effective.

To maintain and protect the surface of your glass cooktop, follow these steps:

- 1 Before using the cooktop for the first time, clean it with the cooktop cleaning cream. This helps protect the top and makes clean-up easier.
- 2 Daily use of the cooktop cleaning cream will help keep the cooktop looking new.

- 3 Shake the cleaning cream well. Apply a few drops of the cream directly to the cooktop.
- 4 Use a paper towel or sponge to clean the entire cooktop surface.

**NOTE:** It is very important that you **DO NOT** heat the cooktop until it has been cleaned thoroughly.

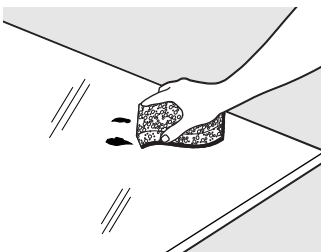

Scotch-Brite® Multi-Purpose No Scratch blue scrub pad

## Burned-On Residue

**WARNING:** DAMAGE to your glass surface may occur if you use scrub pads other than BLUE Scotch-Brite® Multi-Purpose No Scratch scrub pads by 3M.

- 1 Allow the cooktop to cool.
- 2 Spread a few drops of Cerama Bryte® to the entire burned residue area.
- 3 Using the Scotch-Brite® blue pad, rub the residue area, applying pressure as needed.

- 4 If any residue remains, repeat the steps listed above as needed.
- 5 For additional protection, after all residue has been removed, polish the entire surface with Cerama Bryte® and a paper towel.

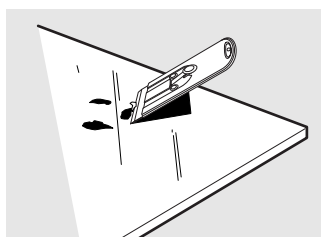

The RAZOR SCRAPER is available through our Parts Center. See instructions under "To Order Parts" section on next page.

**NOTE:** Razor blade is packed inverted for safety reasons. Prior to use, the blade must be rotated and reinserted into slot. Do not use a dull or nicked blade.

## Heavy, Burned-On Residue

- 1 Allow the cooktop to cool.
- 2 Spread a few drops of Cerama Bryte® to the entire burned residue area.
- 3 Hold the razor scraper at approximately a 45° angle against the glass surface and scrape the soil. It will be necessary to apply pressure to the razor scraper in order to remove the residue.
- 4 Keep a small amount of cream on the residue as you scrape.
- 5 After scraping with the razor scraper, use the Scotch-Brite® blue pad to remove any remaining residue.

- 6 For additional protection, after all residue has been removed, polish the entire surface with Cerama Bryte® and a paper towel.

**NOTE:** Razor blade is packed inverted for safety reasons. Prior to use, the blade must be rotated and reinserted into slot. Do not use a dull or nicked blade.

## Cleaning the glass cooktop.

### Metal Marks and Scratches

- 1 Be careful not to slide pots and pans across your cooktop. It will leave metal markings on the cooktop surface.

These marks are removable using the cleaning cream with a Scotch-Brite® blue pad and/or razor scraper.

- 2 If pots with a thin overlay of aluminum or copper are allowed to boil dry, the overlay may leave black discoloration on the cooktop.

This should be removed immediately before heating again or the discoloration may be permanent.

**WARNING:** Carefully check the bottom of pans for roughness that would scratch the cooktop.

### Cooktop Seal

To clean the cooktop seal around the edges of the glass, lay a wet cloth on it for a few minutes, then wipe clean with nonabrasive cleaners.

## Glass surface – potential for permanent damage.

*Our testing shows that if you are cooking high sugar mixtures such as jelly or fudge and have a spillover, it can cause permanent damage to the glass surface unless the spillover is immediately removed.*

### Damage from Sugary Spills and Melted Plastic

- 1 Turn off all surface units. Remove hot pans.
- 2 Wearing an oven mitt:
- Use the razor scraper to move the spill to a cool area on the cooktop.
  - Remove the spill with paper towels.

- 3 Any remaining spillover should be left until the surface of the cooktop has cooled.

- 4 Don't use the surface units again until all of the residue has been completely removed.

**NOTE:** If pitting or indentation in the glass surface has already occurred, the cooktop glass will have to be replaced. In this case, service will be necessary.

### To Order Parts

To order Cerama Bryte® cream and the razor scraper, please call our toll-free number:

**National Parts Center**      **800-626-2002.**

**Cerama Bryte® Cream** . . . . . # WX10X300

**Razor Scraper** . . . . . # WX5X1614

**Kit** . . . . . # WB64X5027

(Kit includes cream and razor scraper)

# Before You Call For Service...



**Troubleshooting Tips**  
 Save time and money! Review the charts on the following pages first and you may not need to call for service.

<b>Problem</b>	<b>Possible Causes</b>	<b>What To Do</b>
<b>Surface units will not maintain a rolling boil or cooking is not fast enough</b>	Improper cookware being used.	<ul style="list-style-type: none"> <li>Use pans which are flat and match the diameter of the surface unit selected.</li> </ul>
<b>Surface units do not work properly</b>	<p>A fuse in your home may be blown or the circuit breaker tripped.</p> <p>Cooktop controls improperly set.</p>	<ul style="list-style-type: none"> <li>Replace the fuse or reset the circuit breaker.</li> <li>Check to see the correct control is set for the surface unit you are using.</li> </ul>
<b>Scratches (may appear as cracks) on cooktop glass surface</b>	<p>Incorrect cleaning methods being used.</p> <p>Cookware with rough bottoms being used or coarse particles (salt or sand) were between the cookware and the surface of the cooktop.</p> <p>Cookware has been slid across the cooktop surface.</p>	<ul style="list-style-type: none"> <li>Scratches are not removable. Tiny scratches will become less visible in time as a result of cleaning.</li> <li>To avoid scratches, use the recommended cleaning procedures. Make sure bottoms of cookware are clean before use, and use cookware with smooth bottoms.</li> </ul>
<b>Areas of discoloration on the cooktop</b>	<p>Food spillovers not cleaned before next use.</p> <p>Hot surface on a model with a light colored glass cooktop.</p>	<ul style="list-style-type: none"> <li>See the <i>Cleaning the glass cooktop</i> section.</li> <li>This is normal. The surface may appear discolored when it is hot. This is temporary and will disappear as the glass cools.</li> </ul>
<b>Plastic melted to the surface</b>	Hot cooktop came into contact with plastic placed on the hot cooktop.	<ul style="list-style-type: none"> <li>See the <i>Glass surface—potential for permanent damage</i> section in the <i>Cleaning the glass cooktop</i> section.</li> </ul>
<b>Pitting (or indentation) of the cooktop</b>	Hot sugar mixture spilled on the cooktop.	<ul style="list-style-type: none"> <li>Call a qualified technician for replacement.</li> </ul>
<b>Frequent cycling off and on of surface units</b>	Improper cookware being used.	<ul style="list-style-type: none"> <li>Use only flat cookware to minimize cycling.</li> </ul>
<b>The display goes blank or indicator lights come on when range is not in use</b>	Power surge.	<ul style="list-style-type: none"> <li>Disconnect power at the fuse box or circuit breaker for at least 10 seconds. Turn power on and power up your range. If the indicator lights are still on, call for service.</li> </ul>
<b>Clock and timer do not work</b>	<p>Plug on range is not completely inserted in the electrical outlet.</p> <p>A fuse in your home may be blown or the circuit breaker tripped.</p> <p>Oven controls improperly set.</p>	<ul style="list-style-type: none"> <li>Make sure electrical plug is plugged into a live, properly grounded outlet.</li> <li>Replace the fuse or reset the circuit breaker.</li> <li>See the <i>Using the clock and timer</i> section.</li> </ul>

## Before You Call For Service...



### Troubleshooting Tips

<b>Problem</b>	<b>Possible Causes</b>	<b>What To Do</b>
<b>Oven light does not work</b>	Light bulb is loose or defective.	• Tighten or replace the bulb.
	Switch operating light is broken.	• Call for service.
<b>Oven will not work</b>	Plug on range is not completely inserted in the electrical outlet.	• Make sure electrical plug is plugged into a live, properly grounded outlet.
	A fuse in your home may be blown or the circuit breaker tripped.	• Replace the fuse or reset the circuit breaker.
	Oven controls improperly set.	• See the <i>Using the oven</i> section.
	Door left in the locked position.	• If necessary, allow the oven to cool then unlock the door.
<b>Food does not bake or roast properly</b>	Oven controls improperly set.	• See the <i>Using the oven</i> section.
	Shelf position is incorrect or the shelf is not level.	• See the <i>Using the oven</i> section.
	Incorrect cookware or cookware of improper size being used.	• See the <i>Using the oven</i> section.
	Oven thermostat needs adjustment.	• See the <i>Adjust the oven thermostat—Do it yourself!</i> section.
<b>Food does not broil properly</b>	Oven controls improperly set.	• Make sure you turn the knob all the way to the <b>BROIL</b> position.
	Door not open to the broil stop position as recommended.	• See the <i>Using the oven</i> section.
	Improper shelf position being used.	• See the <i>Broiling Guide</i> .
	Cookware not suited for broiling.	• Use the broiling pan and grid that came with your range.
	Aluminum foil used on the broiling pan and grid has not been fitted properly and slit as recommended.	• See the <i>Using the oven</i> section.
	In some areas the power (voltage) may be low.	• Preheat the broil element for 10 minutes. • Broil for the longest period of time recommended in the <i>Broiling Guide</i> .
<b>Oven temperature too hot or too cold</b>	Oven thermostat needs adjustment.	• See the <i>Adjust the oven thermostat—Do it yourself!</i> section.

<b>Problem</b>	<b>Possible Causes</b>	<b>What To Do</b>
<b>Power outage, clock flashes</b>	Power outage or surge.	<ul style="list-style-type: none"> <li>Some models will automatically resume their setting once the power is restored. On models with a clock, you must reset the clock. If the oven was in use, you must reset it by turning the Oven Temperature knob back to <b>OFF</b>, setting the clock and resetting any cooking function.</li> </ul>
<b>Storage drawer is crooked</b>	Rear drawer support is on top of the guide rail.	<ul style="list-style-type: none"> <li>Reposition the drawer. See the <i>Storage Drawer Removal</i> instructions in the <i>Care and cleaning of your range</i> section.</li> </ul>
<b>Storage drawer won't close</b>	Power cord may be obstructing drawer in the lower back of the range.	<ul style="list-style-type: none"> <li>Reposition the drawer and power cord. See the <i>Storage Drawer Removal</i> instructions in the <i>Care and cleaning of your range</i> section.</li> </ul>
	Rear drawer support is on top of the guide rail.	<ul style="list-style-type: none"> <li>Reposition the drawer. See the <i>Storage Drawer Removal</i> instructions in the <i>Care and cleaning of your range</i> section.</li> </ul>
<b>Oven will not self-clean</b>	The oven temperature is too high to set a self-clean operation.	<ul style="list-style-type: none"> <li>Allow the range to cool to room temperature and reset the controls.</li> </ul>
	Oven controls improperly set.	<ul style="list-style-type: none"> <li>Make sure you turn the control knob all the way to the <b>CLEAN</b> position.</li> </ul>
	Oven door is not in the locked position.	<ul style="list-style-type: none"> <li>Make sure you move the door latch handle all the way to the right.</li> </ul>
<b>Oven starts a self-clean cycle when you wanted to bake, roast or broil</b>	Oven door locked during cooking.	<ul style="list-style-type: none"> <li>Turn the Oven Temperature knob to <b>OFF</b>. Allow the oven to cool. Never force the door latch handle.</li> </ul>
<b>"Crackling" or "popping" sound</b>	This is the sound of the metal heating and cooling during both the cooking and cleaning functions.	<ul style="list-style-type: none"> <li>This is normal.</li> </ul>
<b>Excessive smoking during a clean cycle</b>	Excessive soil.	<ul style="list-style-type: none"> <li>Turn the Oven Temperature knob to <b>OFF</b>. Open the windows to rid the room of smoke. Wait until the <b>CLEAN</b> light goes off. Wipe up the excess soil and reset the clean cycle.</li> </ul>
<b>Oven door will not unlock</b>	Oven too hot.	<ul style="list-style-type: none"> <li>Allow the oven to cool below locking temperature.</li> </ul>
<b>CLEAN light flashes</b>	Oven controls not properly set.	<ul style="list-style-type: none"> <li>Move the door latch handle to the right before setting the Oven Temperature knob to <b>CLEAN</b>.</li> </ul>

## Before You Call For Service...



### Troubleshooting Tips

<b>Problem</b>	<b>Possible Causes</b>	<b>What To Do</b>
<b>Oven not clean after a clean cycle</b>	Oven controls not properly set.	<ul style="list-style-type: none"> <li>• See the <i>Using the self-cleaning oven</i> section.</li> </ul>
	Oven was heavily soiled.	<ul style="list-style-type: none"> <li>• Clean up heavy spillovers before starting the clean cycle. Heavily soiled ovens may need to self-clean again or for a longer period of time.</li> </ul>
<b>Oven makes clicking noise</b>	This is the sound of the heating element turning off and on during cooking functions.	<ul style="list-style-type: none"> <li>• This is normal.</li> </ul>
<b>CLEAN light is on when you want to cook</b>	The oven door was accidentally locked.	<ul style="list-style-type: none"> <li>• Turn the Oven Temperature knob to <b>OFF</b>. Allow the oven to cool. Then move the latch to the far left. Never force the door latch handle.</li> </ul>
<b>"F— and a number or letter" flash in</b>	You have a function error code.	<ul style="list-style-type: none"> <li>• Turn the Oven Temperature knob to <b>OFF</b>. Put the oven back into operation.</li> </ul>
	If the function code repeats.	<ul style="list-style-type: none"> <li>• Disconnect all power to the range for at least 30 seconds and then reconnect power. If the function error code repeats, call for service.</li> </ul>
<b>The display goes blank or indicator lights come on when range is not in use</b>	Power surge.	<ul style="list-style-type: none"> <li>• Disconnect power at the fuse box or circuit breaker for at least 10 seconds. Turn power on and power up your range. If the indicator lights are still on, call for service.</li> </ul>
	The clock is in the black-out mode.	<ul style="list-style-type: none"> <li>• See the <i>Using the clock and timer</i> section.</li> </ul>
<b>Oven door will not lock</b>	Oven too hot.	<ul style="list-style-type: none"> <li>• Turn the Oven Temperature knob to <b>CLEAN</b>. The glowing oven cleaning light after the knob is turned indicates the oven is too hot from previous use. To cool the oven, open the door wide, and allow the oven to cool. After the oven has cooled, close the door and slide the latch handle all the way to the right.</li> </ul>
<b>"Burning" or "oily" odor emitting from the vent</b>	This is normal in a new oven and will disappear in time.	<ul style="list-style-type: none"> <li>• To speed the process, set a self-clean cycle for a minimum of 3 hours. See the <i>Using the self-cleaning oven</i> section.</li> </ul>
<b>Strong odor</b>	An odor from the insulation around the inside of the oven is normal for the first few times the oven is used.	<ul style="list-style-type: none"> <li>• This is temporary.</li> </ul>

## GE Service Protection Plus™

GE, a name recognized worldwide for quality and dependability, offers you Service Protection Plus™—comprehensive protection on all your appliances—**No Matter What Brand!**

**Benefits Include:**

- Backed by GE
- All brands covered
- Unlimited service calls
- All parts and labor costs included
- No out-of-pocket expenses
- No hidden deductibles
- One 800 number to call

***We'll Cover Any Appliance.  
Anywhere. Anytime.\****

You will be completely satisfied with our service protection or you may request your money back on the remaining value of your contract. No questions asked. It's that simple.

Protect your refrigerator, dishwasher, washer and dryer, range, TV, VCR and much more—**any brand!** Plus there's no extra charge for emergency service and low monthly financing is available. Even icemaker coverage and food spoilage protection is offered. You can rest easy, knowing that all your valuable household products are protected against expensive repairs.

Place your confidence in GE and call us in the U.S. toll-free at **800.626.2224** for more information.

\*All brands covered, up to 20 years old, in the continental U.S.

 Cut here

Please place in envelope and mail to:

***General Electric Company***  
**Warranty Registration Department**  
**P.O. Box 32150**  
**Louisville, KY 40232-2150**

# Consumer Product Ownership Registration

Dear Customer:

Thank you for purchasing our product and thank you for placing your confidence in us. We are proud to have you as a customer!

Follow these three steps to protect your new appliance investment:

# 1

Complete and mail your Consumer Product Ownership Registration today. Have the peace of mind of knowing we can contact you in the unlikely event of a safety modification.

# 2

After mailing the registration below, store this document in a safe place. It contains information you will need should you require service. Our service number is 800.GE.CARES (800.432.2737).

# 3

Read your Owner's Manual carefully. It will help you operate your new appliance properly.

Model Number

Serial Number

**Important: If you did not get a registration card with your product, detach and return the form below to ensure that your product is registered, or register online at [GEAppliances.com](http://GEAppliances.com).**

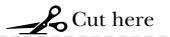

## Consumer Product Ownership Registration



Model Number

Serial Number

Mr.  Ms.  Mrs.  Miss

First Name

Last Name

Street Address

Apt. #

E-mail Address\*

City

State

Zip Code

Date Placed In Use Month

Day

Year

Phone Number  -  -

\* Please provide your e-mail address to receive, via e-mail, discounts, special offers and other important communications from GE Appliances (GEA).

Check here if you do not want to receive communications from GEA's carefully selected partners.



**GE Appliances**

General Electric Company  
Louisville, Kentucky  
[GEAppliances.com](http://GEAppliances.com)

# GE Electric Range Warranty.



All warranty service provided by our Factory Service Centers, or an authorized Customer Care® technician. To schedule service, on-line, 24 hours a day, contact us at [GEAppliances.com](http://GEAppliances.com), or call 800-GE-CARES.

Staple your receipt here. Proof of the original purchase date is needed to obtain service under the warranty.

For The Period Of:	GE Will Provide:
<b>One Year</b> From the date of the original purchase	<b>Any part</b> of the range which fails due to a defect in materials or workmanship. During this <b>full one-year warranty</b> , GE will also provide, <b>free of charge</b> , all labor and in-home service to replace the defective part.
<b>Five Years</b> From the date of the original purchase	<b>A replacement glass cooktop</b> if it should crack due to thermal shock, discolor, crack at the rubber seal between the glass cooktop and the porcelain edge, or if the pattern wears off. <b>A replacement radiant surface unit</b> if it should burn out. During this <b>limited additional four-year warranty</b> , you will be responsible for any labor or in-home service.

## What GE Will Not Cover:

- Service trips to your home to teach you how to use the product.
- Improper installation.
- Failure of the product if it is abused, misused, or used for other than the intended purpose or used commercially.
- Damage to the glass cooktop caused by use of cleaners other than the recommended cleaning creams.
- Damage to the glass cooktop caused by hardened spills of sugary materials or melted plastic that are not cleaned according to the directions in the Owner's Manual.
- Replacement of house fuses or resetting of circuit breakers.
- Damage to the product caused by accident, fire, floods or acts of God.
- Incidental or consequential damage caused by possible defects with this appliance.

*This warranty is extended to the original purchaser and any succeeding owner for products purchased for home use within the USA. In Alaska, the warranty excludes the cost of shipping or service calls to your home.*

*Some states do not allow the exclusion or limitation of incidental or consequential damages. This warranty gives you specific legal rights, and you may also have other rights which vary from state to state. To know what your legal rights are, consult your local or state consumer affairs office or your state's Attorney General.*

**Warrantor: General Electric Company, Louisville, KY 40225**

Safety Instructions

Operating Instructions

Care and Cleaning

Troubleshooting Tips

Consumer Support

## Consumer Support.

---



### *GE Appliances Website*

**GEAppliances.com**

Have a question or need assistance with your appliance? Try the GE Appliances Website 24 hours a day, any day of the year! For greater convenience and faster service, you can now download Owner's Manuals, order parts, catalogs, or even schedule service on-line. You can also "Ask Our Team of Experts™" your questions, and so much more...



### *Schedule Service*

**GEAppliances.com**

Expert GE repair service is only one step away from your door. Get on-line and schedule your service at your convenience 24 hours any day of the year! Or call 800.GE.CARES (800.432.2737) during normal business hours.



### *Real Life Design Studio*

**GEAppliances.com**

GE supports the Universal Design concept—products, services and environments that can be used by people of all ages, sizes and capabilities. We recognize the need to design for a wide range of physical and mental abilities and impairments. For details of GE's Universal Design applications, including kitchen design ideas for people with disabilities, check out our Website today. For the hearing impaired, please call 800.TDD.GEAC (800.833.4322).



### *Extended Warranties*

**GEAppliances.com**

Purchase a GE extended warranty and learn about special discounts that are available while your warranty is still in effect. You can purchase it on-line anytime, or call 800.626.2224 during normal business hours. GE Consumer Home Services will still be there after your warranty expires.

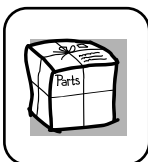

### *Parts and Accessories*

**GEAppliances.com**

Individuals qualified to service their own appliances can have parts or accessories sent directly to their homes (VISA, MasterCard and Discover cards are accepted). Order on-line today, 24 hours every day or by phone at 800.626.2002 during normal business hours.

***Instructions contained in this manual cover procedures to be performed by any user. Other servicing generally should be referred to qualified service personnel. Caution must be exercised, since improper servicing may cause unsafe operation.***



### *Contact Us*

**GEAppliances.com**

If you are not satisfied with the service you receive from GE, contact us on our Website with all the details including your phone number, or write to: General Manager, Customer Relations  
GE Appliances, Appliance Park  
Louisville, KY 40225



### *Register Your Appliance*

**GEAppliances.com**

**Register your new appliance on-line—at your convenience!** Timely product registration will allow for enhanced communication and prompt service under the terms of your warranty, should the need arise. You may also mail in the pre-printed registration card included in the packing material.