





Use and Care Guide

Dishwasher

| | |
|---|-----------------------------------|
|  | Safety instructions3 |
|---|-----------------------------------|

| | |
|---|---|
|  | Operating Instructions, Tips |
| | Appliance Registration2 |
| | China, Crystal, Sterling 10 |
| | Cycle Features4, 5 |
| | Cycle Selection Chart5 |
| | Detergent Guide7 |
| | Dispenser Cups7 |
| | Drying Options4 |
| | Energy-Saving Tips2 |
| | Features4, 5 |
| | Loading8, 9 |
| | Operating instructions4, 5 |
| | Rinse Agent6 |
| | Water Temperature6 |

| | |
|---|-------------------------------|
|  | Care and Cleaning |
| | Air Gap 11 |
| | Winter Storage11 |

| | |
|--|---------------------------------------|
|  | Problem Solver15-17 |
| | More questions ?...call |
| | GE Answer Center™ 800.626.2000 |

| | |
|--|-------------------------------------|
|  | Preparation |
| | Front Panel, Change 12 |

| | |
|---|---|
|  | Consumer Services 19 |
| | Important Phone Numbers 19 |
| | Model and Serial Numbers2 |
| | Repair Service2 |
| | WarrantyBackCover |

Models GSD650, GSD680



HELP US HELP YOU...

Before using your dishwasher, read this guide carefully.

It is intended to help you operate and maintain your new dishwasher properly.

Keep it handy for answers to your questions.

If You don't understand something or-need more help, write (include your phone number):

Consumer Affairs
GE Appliances
Appliance Park
Louisville, KY 40225

If you received a damaged dishwasher...

Immediately contact the dealer (or builder) that sold you the dishwasher.

Save time and money. Before you request service . . .

Check the Problem Solver in the back of this guide. It lists causes of minor **operating** problems that you can correct yourself.

Write down the model and serial numbers.

You'll find them on a label fastened to the tub wall just inside the dishwasher door.

These numbers are also on the Consumer Product Ownership Registration Card that came with your dishwasher. Before sending in this card, please write these numbers here:

Model Number

Serial Number

Use these numbers in any correspondence or service calls concerning your dishwasher.

To obtain a Spanish language version of this book, call GE Answer Center® 800.626.2000 consumer information service.

Para obtener la versión en español de este manual, name a GE Answer Center®, servicio de información para el consumidor, teléfono 800.626.2000.

IF YOU NEED SERVICE...

To obtain service, see the Consumer Services page in the back of this guide.

We're proud of our service and want you to be pleased. If for some reason you are not happy with the service you receive, here are three steps to follow for further help.

FIRST, contact the people who serviced your appliance. Explain why you are not pleased. In most cases, this will solve the problem.

NEXT, if you are still not pleased, write all the details—including your phone number—to:

Manager, Consumer Relations
GE Appliances
Appliance Park
Louisville, KY 40225

FINALLY, if your problem is still not resolved, write:

Major Appliance Consumer Action Panel
20 North Wacker Drive
Chicago, IL 60606

ENERGY-SAVING TIPS

- Operate dishwasher only when it's full. Let the dishes accumulate in dishwasher. When you put in only a partial load, use the RINSE & HOLD cycle to rinse off heavy soils.
- Always select the cycle that uses least amount of water that will remove the soil from the load. (See the Operating section).
- If you don't need your dishes right away, allow the dishes to dry naturally over a longer period such as overnight.

IMPORTANT SAFETY INSTRUCTIONS

Read all instructions before using this appliance.



A

WARNING—When using this appliance, always exercise basic safety precautions, including the following:

- Use this appliance only for its intended purpose, as you will find described in this Use and Care Guide.



• This dishwasher must be properly installed and located in accordance with the Installation Instructions before it is used. If you did not receive an Installation Instructions sheet with your dishwasher, you can obtain one by calling, toll free, the GE Answer Center,® 800.626.2000.

—This appliance must be connected to a grounded metal, permanent wiring system; or an equipment-grounding conductor must be run with the circuit conductors and connected to the equipment-grounding terminal or lead of the appliance.

—Connect to a properly rated, protected and sized power-supply circuit to avoid electrical overload.



• Do not store or use combustible materials, gasoline or other flammable vapors and liquids in the vicinity of this or any other appliance.

- Use only powder or liquid detergents or wetting agents recommended for use in a dishwasher.
- Do not wash plastic items unless marked “dishwasher safe” or the equivalent. For plastic items not so marked, check the manufacturer’s recommendations.
- Load light plastic items so they will not become dislodged and drop to the bottom of the dishwasher—they might come into contact with the heating element and be damaged.

To minimize the possibility of injury.

- When loading items to be washed:
 - A. Locate sharp items so that they are not likely to damage the door seal, and
 - B. Load sharp knives with the handles up to reduce the risk of cut-type injuries,
- Do not tamper with controls.

- Do not touch the heating element during or immediately after use.
- Do not operate your dishwasher unless all enclosure panels are properly in place,
- Do not abuse, sit on, or stand on the door or dish rack of the dishwasher,
- Close supervision is necessary if this appliance is used by or near children. Do not allow children to play inside, on or with this appliance or any discarded appliance. Dispose of discarded appliances and shipping or packing material properly. Before discarding a dishwasher, remove the door of the washing compartment.
- Keep all washing detergents and wetting agents out of the reach of children, preferably in a locked cabinet. Observe all warnings on container labels to avoid personal injury.



• To minimize the possibility of electric shock, disconnect this appliance from the power supply before attempting any maintenance. NOTE: Turning the control dial to the OFF position does not disconnect the appliance from the power supply. We recommend having a qualified technician service your appliance.

A

WARNING—HYDROGEN GAS is produced by the chemical action within your water heater. It can accumulate in the water heater and/or water pipes if hot water has not been used for a period of two weeks or longer. **HYDROGEN GAS IS EXPLOSIVE.** To prevent the possibility of damage or injury, if you have not used hot water for two weeks or more, or moved into a residence in which the hot water system may not have been used for some time, turn on all hot water faucets and allow them to run for several minutes before using any electrical appliance which is connected to the hot water system. This will allow any hydrogen gas to escape. Also, since the gas is flammable, do not smoke or use an open flame or appliance during this process.

SAVE THESE INSTRUCTIONS



HOW TO OPERATE YOUR DISHWASHER

NOTE: If dishwasher drains into a food waste disposal, operate the disposal until it is empty before starting dishwasher.

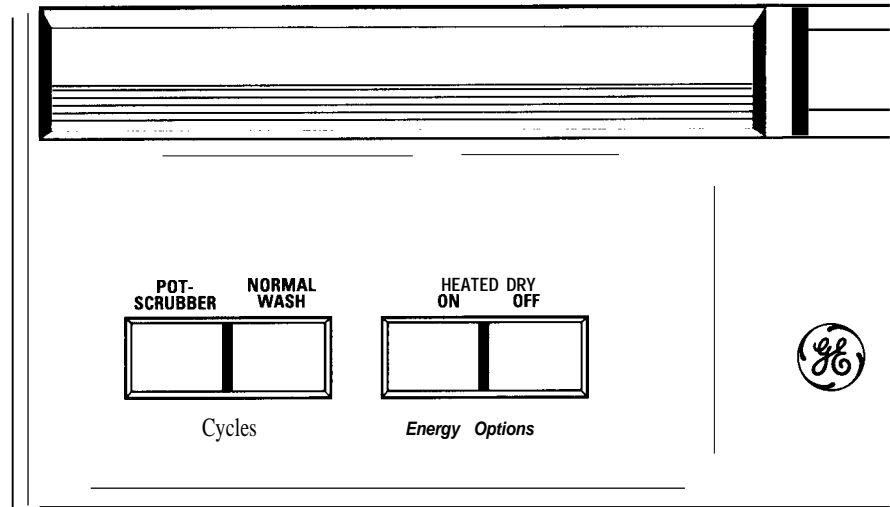

Features and (appearance may vary slightly.

Step 1. Load your dishwasher.
(See Loading section.)

Step 2. Make sure the Cycle Indicator Dial is at the OFF position. Add detergent to the detergent dispenser. (See Detergent Guide.) Use a rinse aid agent to help prevent spotting. (See How to Use a Rinse Agent section.)

Step 3. Latch the door.

Step 4. Select desired wash cycle.

- **POTSCRUBBER**—For items such as pots, pans and casseroles with dried-on or baked-on soils. Everyday dishes may be included. This cycle will get heavily soiled dishes cleaner than the normal cycle. It will not remove burned-on foods.
- **NORMAL WASH**—For most loads of everyday dishes, glasses and cookware with medium soils. Designed to yield high performance on normal soils.

Step 5. Select the desired Energy Options.

- **HEATED DRY ON**—Turns the drying heater on for fast drying. When selected, the cycle time will be extended for 35 minutes.
- **HEATED DRY OFF**—Shuts off the heating unit, thus saving energy. Dishes air-dry naturally. It takes longer but saves energy. You can open the door after the motor stops to speed drying. Excellent for overnight drying.

Step 6. Turn the Cycle Indicator Dial to START.

- Turning the dial to START will begin the cycle immediately. To obtain the benefits of a complete cycle, be careful that you do not turn the dial any farther than is necessary to start the dishwasher. There is a time delay between start-up and water fill so you will not hear any wash action right away.

Dial Cycles

The **SHORT WASH** cycle allows you to quickly wash loads of everyday dishes with medium soils that have not dried on, such as loads consisting mostly of glasses.

- Select The **NORMAL WASH** cycle and any Energy Option if desired.
- Be sure the door is unlatched.
- Slowly turn the Cycle Indicator Dial to **SHORT WASH**.
- Latch the door to start the cycle.

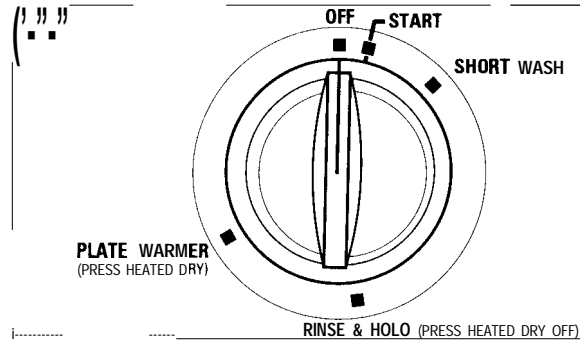
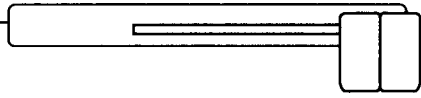

Dial Cycles (continued)

The RINSE & HOLD cycle is for rinsing partial loads which will be washed later. *Do not use detergent.*

- a. Select HEATED DRY OFF.
- b. Be sure the door is unlatched.
- c. Slowly turn the Cycle Indicator Dial to RINSE & HOLD.
- d. Latch the door to start the cycle.

The PLATE WARMER cycle (on some models) is for warming clean dishes and serving plates for the serving of hot foods. The cycle will take approximately 35 minutes if selected.

- a. Load clean plates and dishes to be warmed.
- b. Select HEATED DRY ON.
- c. Be sure the door is unlatched.
- d. Slowly turn the Cycle Indicator dial to **PLATE WARMER**.
- e. Latch the door to start the cycle.

Cycle Selection Chart

| Wash Cycles | Water Use Gallons (approx.) | Wash Cycle Time Minutes (approx.) | Cycle Sequence | | | | | | |
|--------------|-----------------------------------|--|----------------|-------|-------|-----------|-------|-------|-------|
| | | | Rinse | Rinse | Rinse | Main Wash | Rinse | Rinse | Rinse |
| POTSCRUBBER | 10.6 | 72 | Rinse | Rinse | Rinse | Main Wash | Rinse | Rinse | Rinse |
| NORMAL WASH | 9.1 | 51 | | Rinse | Rinse | Main Wash | Rinse | Rinse | Rinse |
| SHORT WASH | 7.4 | 43 | | | Rinse | Main Wash | Rinse | Rinse | Rinse |
| RINSE & HOLD | 3.0 | 12 | | | | | | Rinse | Rinse |

Drying Options:

HEATED DRY ON. Available on all wash cycles except RINSE & HOLD. Add 35 minutes to wash cycle time.

HEATED DRY OFF. Drying heater is turned off. Dishes dry naturally.



Good Dishwashing Starts with HOT Water

To get dishes clean and dry, you need hot water. For good washing and drying, the entering water must be at least 120°F. To prevent dish damage, inlet water should not exceed 150°F.

How to Test Water Temperature

Check your water temperature with a candy or meat thermometer. Turn on the hot water faucet nearest the dishwasher. Put the thermometer in a glass and let the water run continuously into the glass until the temperature stops rising. If the water temperature is below 120°F., adjust your water heater.

Helpful hints: If outside temperatures are unusually low, or if your water travels a long distance from water heater to dishwasher, you may need to set your water heater's thermostat up. If you have not used hot water for some time, the water in the pipes will be cold. Turn on the hot water faucet at the sink and allow it to run until the water is hot. Then start the dishwasher. If you've recently done laundry or run hot water for showers, give your water heater time to recover before operating the dishwasher.

To improve washability if the water is less than 120°F. and you cannot adjust your water heater: Select a longer cycle and fill both detergent cups at least half-full with detergent.

How to Use a Rinse Agent

The rinse agent makes water flow off dishes quicker than usual. This lessens water spotting and makes drying faster, too.

For best dishwashing performance, use of a rinse agent such as JET-DRY brand is recommended.

Rinse agents come in either liquid or solid form. Your dishwasher uses the liquid form.

How to fill the rinse agent dispenser.

Unscrew the cap. Note the FULL line on the top of the cap. Add liquid rinse agent until it just reaches the top of the FULL line. Replace the cap. The dispenser automatically releases the rinse agent into the final rinse water.

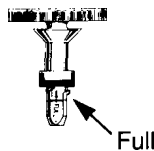

Your dishwasher's rinse agent container holds approximately 4½ ounces. This should last about 3 months. Fill as needed.

If you accidentally spill: Wipe up the rinse agent with a damp cloth. Don't leave the spill in the dishwasher. It can keep your detergent from working.

If you can't find any rinse agent, write:

BENCKISER CONSUMER PRODUCTS, INC.
("JET-DRY")
Corporate Centre 1
55 Federal Road
P.O. Box 1991
Danbury, CT 06813-1991



How to Choose and Use the Right Detergent

Use only powder or liquid detergent specifically made for use in dishwashers. Other types will cause oversudsing.

How much detergent should you use? That depends. Is your water “hard” or “soft”? With hard water, you need extra detergent to get dishes clean. With soft water, you need less detergent.

Your water department can tell you how hard your water is. So can your county extension agent or your area’s water softener company. Just call and ask them how many “grains” of hardness there are in your water.

Too much detergent with soft water not only wastes money, it can be harmful. It can cause a permanent

cloudiness of glassware, called “etching.” An outside layer of glass is etched away! Of course, this takes some time. But why take a chance when it’s easy to find out the hardness of your water.

Keep your detergent fresh and dry. Under the sink isn’t a good place to store detergent because there is too much moisture. Don’t put powder detergent into the dispenser until you’re ready to wash dishes, either. (It won’t be fresh OR dry.)

If your powder detergent gets old or lumpy, throw it away. Old detergent often won’t dissolve. If you use a liquid dishwasher detergent, these precautions are not necessary because liquid detergents don’t “lump” as they age or come in contact with moisture.

Detergent Dispensers

You’ll find two detergent dispensers on the inside door of your dishwasher. Two, because some cycles use two washes.

See “Detergent Usage Guide” below. (Be sure the **CYCLE INDICATOR DIAL** is at **OFF** position before adding detergent. Otherwise, the detergent cup will not close and latch properly).

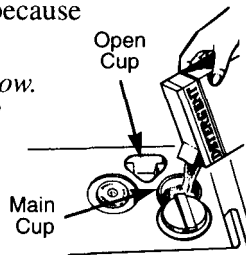

Close the *main* cup.

NOTE: To open detergent cup after it has been closed, unlatch the door and rotate the Cycle Indicator Dial a full turn to the OFF position.

When the closed cup contains soap it is best that the door be in a partially open position before rotating the Cycle Indicator Dial. This will help reduce the amount of detergent and rinse aid agent spillage into the tub.

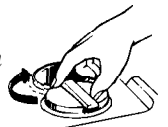

Grasp handle, rotate and close tightly

Detergent Usage Guide (powder or liquid)

| CYCLES | SOFT WATER (0-3 grains hardness) | | MEDIUM WATER (3-7 grains) | | HARD WATER (7-12 grains*) | |
|----------------------------|----------------------------------|-------------|---------------------------|-------------|---------------------------|-------------------|
| | Main Cup | Open Cup | Main Cup | Open Cup | Main Cup‡ | Open Cup‡ |
| POTSCRUBBER NORMAL WASH | Half Full | + Half Full | Completely Full | + Half Full | Completely Full | + Completely Full |
| SHORT WASH | Half Full | None | Half Full | None | Completely Full | None |
| RINSE & HOLD | Use no detergent | | Use no detergent | | Use no detergent | |

*12 grains and up is extremely hard water. A water softener is recommended. Without it, lime can build up in the water valve. The water valve may stick while open and cause flooding.

‡Filled Main Cup holds 3 tablespoons; Filled Open Cup holds 2 tablespoons.

How to Prepare the Dishes for Washing

If this is your first dishwasher, or if you’re replacing a much older model, you may wonder how much preparation your dishes need. Actually very little. Scrape off bones, seeds, skins, toothpicks and other hard solids. Remove excessive quantities of oil or grease.

NOTE: You may also want to consider removing foods such as mustard, mayonnaise, vinegar, lemon juice and other foods that can cause discoloration of stainless steel if allowed to remain on dishes for a long period of time.

The POTSCRUBBER cycle can wash heavily soiled dishes and remove dried-on and baked-on soils from pots, pans and casseroles. Items with burned-on soils need extra preparation.



HOW TO LOAD YOUR DISHWASHER

NOTE: Do not load large platters or trays in front right corner of lower rack. They may prevent detergent from circulating in the wash cycle.

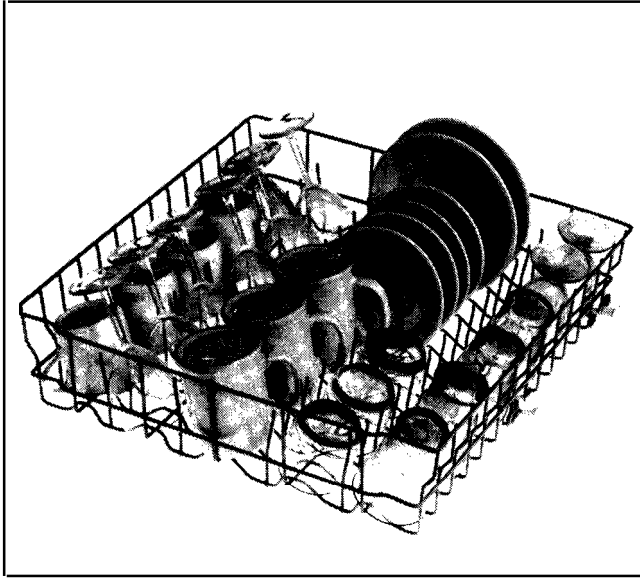

The upper rack is best for glasses, cups and saucers. Cups and glasses fit best along the sides. This is also the place for dishwasher-safe plastics. Make sure small plastic items are lodged in tightly so they can't fall onto the heating unit. Arrange stemware so that it cannot move easily. Don't let the glasses touch each other.

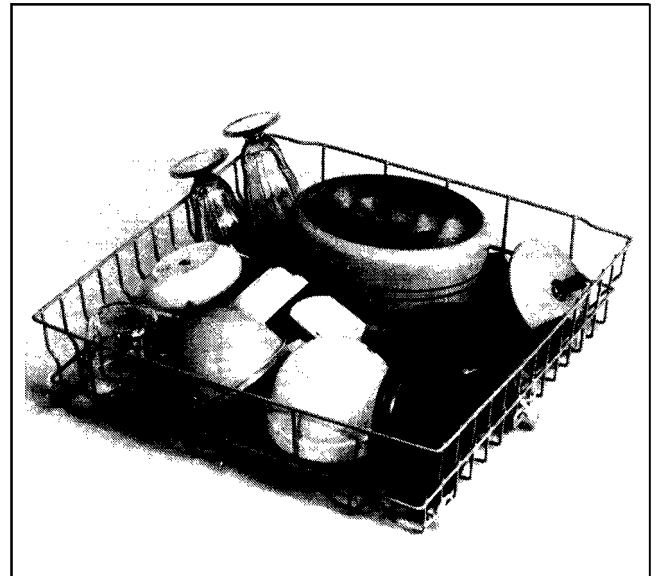
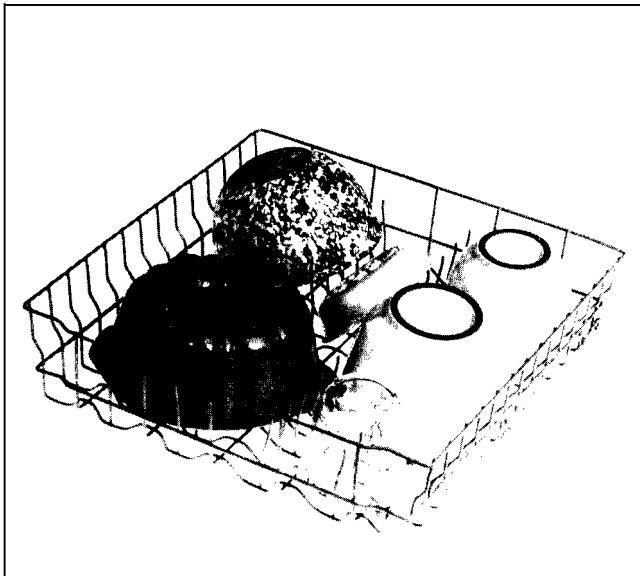

The upper rack is handy for all kinds of odd shapes. Sauce pans, mixing bowls and other items should be placed face down. When loading dishwasher safe plastics make sure each plastic item is secured over two fingers. This will insure good washing results.

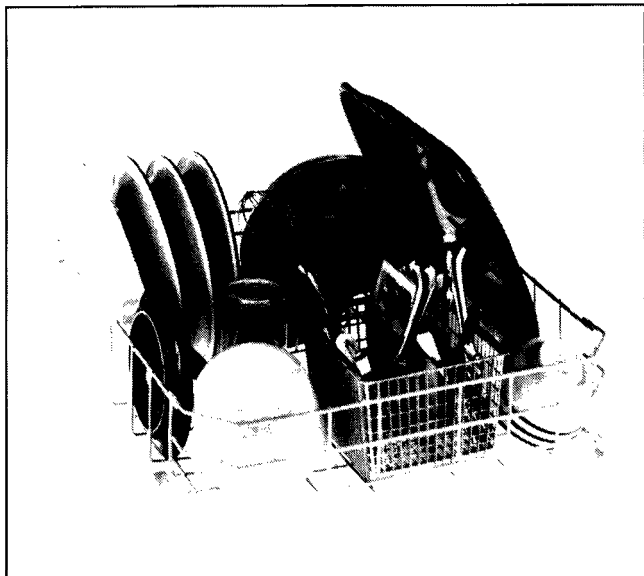
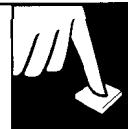

The lower rack is best used for plates, saucers, and cookware. Large items such as broiler pans and racks should go in the lower rack along the edge. Load platters, pots and bowls along the sides, in corners, or in the back. For best washing results, all items should be positioned with the soiled side of the dish facing the center of the rack.

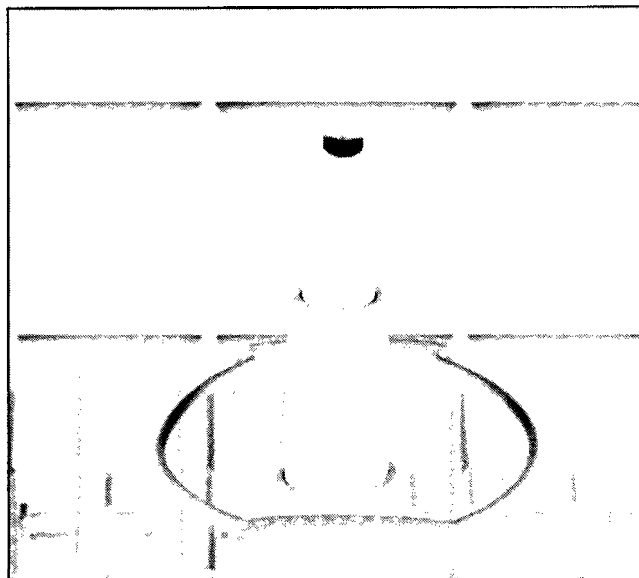

Keep center area clear in the lower rack.

The wash tower rises through the center of the lower rack during the wash and rinse portions of the cycle. Don't block it or load tall things next to it. Also, be careful not to let a portion of an item such as a pot or dish handle extend through the bottom rack. This could block the wash arm and cause poor washing results.

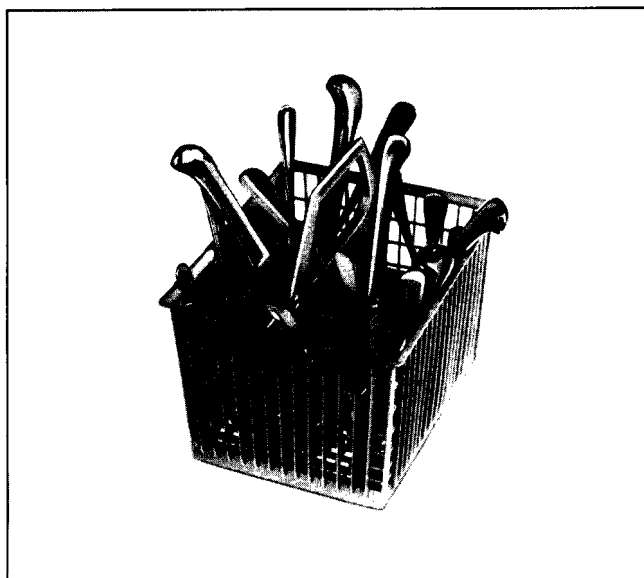

Put flatware in the removable basket with handles **up** to protect your hands. Mix knives, forks and spoons so they don't nest together. Distribute evenly.

Small plastic items, such as measuring spoons and lids from small containers are not recommended for automatic dishwashing. If placed in dishwasher, they should go in bottom of silverware basket with silverware on top.

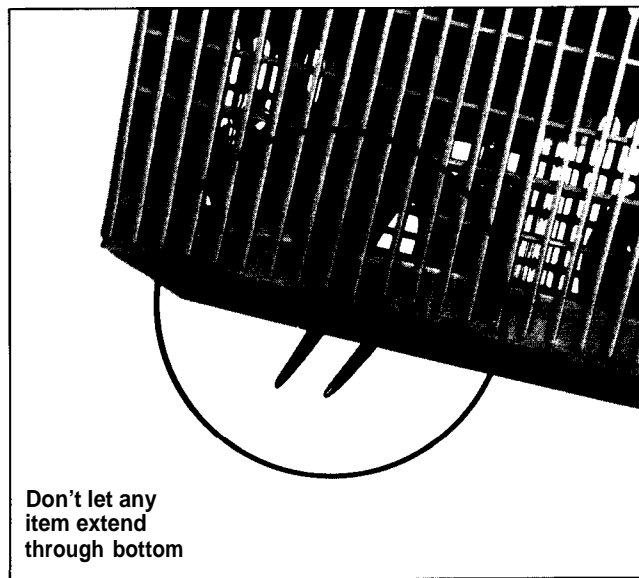

Don't let any item extend through bottom

Precaution!

Take out anything that may fall or extend through the bottom of the basket.



WHAT YOU CAN USUALLY WASH SAFELY IN YOUR DISHWASHER.

| Material | Usually Safe | Exceptions (not safe) | Special Instructions |
|---|--------------|---|--|
| Aluminum | YES | Some colored anodized aluminum can fade. | Some darkening or spotting possible. Remove by scouring with soap-filled steel wool pads. |
| China/ Stoneware | YES | Antique, metal-trimmed, hand-painted or over-the-glaze patterns fade. Gold leaf will discolor. | If in doubt, check with the manufacturer. Or test wash one piece daily for at least a month. Compare with the rest of the set. |
| Crystal | YES | Antique, metal-trimmed or hand-painted patterns fade. Gold leaf will discolor. | Load securely to prevent movement. Check your manufacturer's instructions for your crystal. |
| Non-dishwasher items—such as electronic air cleaner filters, furnace filters, paint brushes, etc. | NO | | Do not wash in dishwasher. Damage to dishwasher and discoloration or staining of dishwasher may result. |
| Glass | YES | | |
| Iron | NO | Iron will rust. | |
| Pewter | NO | Pewter tarnishes. | |
| Plastics | YES | | If it doesn't say DISHWASHER SAFE, test one piece in the top rack before dishwashing an entire set. |
| Stainless steel | YES | | Rinse if not washing immediately. Salty or acid foods can stain if left on. |
| Sterling Silver and Silver plate | YES | Don't put in same silverware basket with stainless steel. Contact between metals can damage silver. Don't wash copper utensils in the same load. Silver may get a brown film. Adhesive used to attach some hollow-handle knives can loosen. | Rinse if not washing immediately. Salty or acid foods can stain if left on. Dry detergent can cause difficult-to-remove black spots. Place in back section of silverware basket to avoid exposure to detergent from the detergent cup. |
| Non-stick coatings | YES | | After washing, wipe the non-stick coating area with vegetable oil to keep it from losing its non-stick quality. |
| Tin | NO | Tin can rust. | |
| Wood | NO | Wood can warp, crack or lose its finish with any type of washing. | |

Forget a dish? Here's when you can add it.

Add dishes any time during the RINSE & HOLD cycle. With other wash cycles, you can add dishes at any time BEFORE the main detergent wash portion of the cycle.

However, opening the door during any cycle lessens cleaning power. So try to load everything at the beginning.

Here's how to add a forgotten dish:

1. Push the door latch to the left. Washing will stop.
2. Wait a few seconds until the water calms. Then open the door. WARNING: Hot vapor may rise from opened door.
3. Add dishes you've forgotten.
4. Close the door and push the latch to the far right. When the door is locked, washing will continue.

CARE AND CLEANING

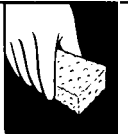

USER MAINTENANCE INSTRUCTIONS

Clean the control panel with a lightly dampened cloth. Dry thoroughly. Do not use abrasives or sharp objects on the panel. They can damage it.

Clean the outside with a good appliance polish wax. The outside cabinet finish is durable, but it can scratch. So use no scouring pads, or harsh or gritty cleaners.

Appliance Polish Wax & Cleaner (Cat. No. WR97X0216) is available from GE Service and Parts Center.

The inside usually takes care of itself. If it should ever need cleaning, use a mild cleansing powder. Scouring pads and harsh cleaners can mar the finish.

Not Using Your Dishwasher in Winter? Protect Against Freezing.

If your dishwasher is left in an unheated place during the winter, ask a service technician to:

- Cut off electrical power to the dishwasher. Remove fuses or trip circuit breaker.
- Turn off the water supply,
- Disconnect the water inlet line from the water valve.

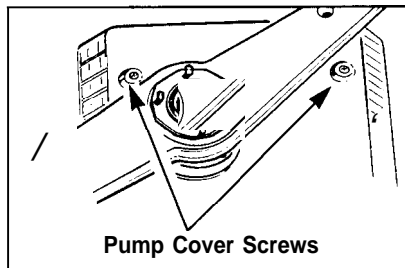

- Drain water from the inlet line and water valve. (Use a pan to catch the water.)
- Reconnect the water inlet line to the water valve.
- Remove the plastic pump cover in the tub bottom and use a sponge to soak up water in the rubber boot.

Built-in Dishwashers Often Use an Air Gap. Keep It Clean.

An air gap is a plumbing device. It protects your dishwasher against water backing up into it if a drain clogs. The air gap is not a part of the dishwasher. And you may not even have one. Not all plumbing codes require air gaps.

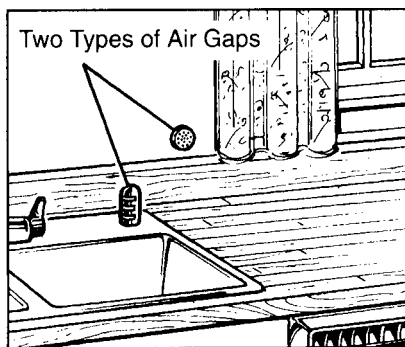

Check the air gap any time your dishwasher isn't draining well.

If you have an air gap, check it at least once a month. **IT IS NOT PART OF YOUR DISHWASHER. IT IS NOT COVERED IN YOUR WARRANTY.**

The air gap is easy to clean. With most types, first turn off the dishwasher, then lift off the chrome cover. Then unscrew the plastic cap and check for any buildup of grit. A toothpick makes cleaning easy.



HOW TO CHANGE COLOR PANELS

If you are redecorating, you can change your dishwasher's front panels to match or blend with your new colors, by flipping them over. Each side of each panel is a different color. You may also paint a panel with a color of your own choice.

How to Change the Door Panel:

1. Take out trim screws on either side of the dishwasher door. Remove the side trim.
2. Slide the door panel out.
(Careful—edges may be sharp.)
3. Turn the door panel around and put the color you want in front.
4. Replace the door panel, side trim and screws.

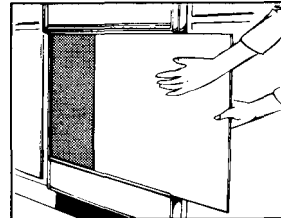

NOTE: Do not operate dishwasher while changing panels or when lower access panel is removed.

How to Change the Lower Panel:

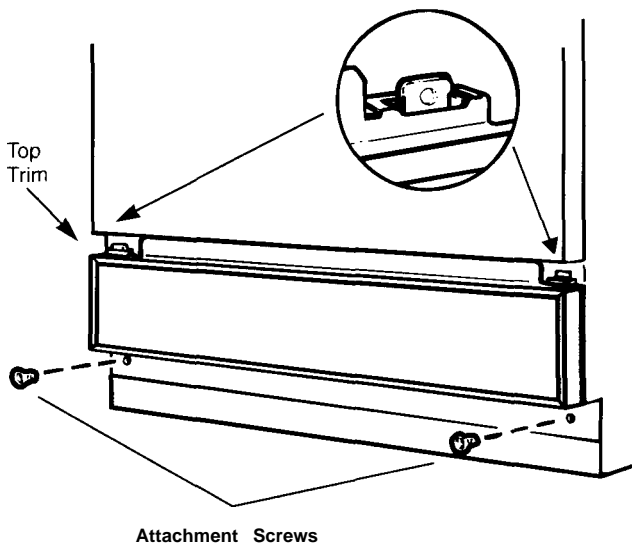

1. Remove the panel attachment screws.
2. Remove the entire access assembly by lifting it up and over the retaining tabs.
3. Take out the top trim screws and remove the top trim.
4. Slide the color panel(s) up and out and put the color you want in front.
5. Replace the top trim and screws.
6. Replace the entire access assembly by hanging it back on the retaining tabs. Hold the access assembly in place and replace attachment screws.

Wood Panel Trim Kits (Available for both models)

Wood panel trim kits, contain trim and instructions for adding a decorative wood door panel and lower access panel no thicker than 1/4" to match kitchen cabinets.

Specify the trim color of your choice from the following options:

- GPF40BC (Chrome Trim and Screws)
- GPF40BK (Black Trim)
- GPF40WH (White Trim)

The kit is available for \$5.00 (shipping and handling).
Make check payable to the General Electric Co.

Color Panels (For model GSD650 only)

If you have redecorated, and the color panels in your dishwasher do not blend with your new color scheme you may order one additional color panel without charge.

Specify the color panel you would like from the following options:

- GPF24 White/Almond
- GPF26 Harvest/Black

Order a Trim Kit or a Color Panel from:

GE Appliances
c/o Dri-View Manufacturing
4706 Allmond Ave.
Louisville, KY 40209

QUESTIONS? USE THIS PROBLEM SOLVER



| PROBLEM | POSSIBLE CAUSE |
|--|---|
| DISHWASHER WON'T RUN | A fuse in your home maybe blown, or the circuit breaker tripped. Replace fuse or reset circuit breaker. Remove any other appliances from the circuit. |
| UNUSUAL NOISE | Utensils may not be secure on rack pins, or something small may have dropped from the rack. Water is causing utensils to rattle. Make sure everything is securely placed in dishwasher. |
| DISHES DON'T DRY | <p>Make sure inlet water temperature is correct. (See How to Test Water Temperature section).</p> <p>Unload the bottom rack first. Water from dishes in the top rack maybe spilling into the bottom rack.</p> <p>Check for improper loading. Dishes shouldn't nest together. Avoid overloading,</p> <p>Check the rinse agent dispenser to see that it's not empty.</p> |
| UNCLEAN DISHES AND FLATWARE | <p>Check inlet water temperature. It should be at least 120°F. (To test, see How to Test Water Temperature section).</p> <p>Water pressure may be temporarily low. Turn on a faucet. Is water coming out slower than usual? If so, wait until pressure is normal before using your dishwasher.</p> <p>Plugged air gap. (See Care and Cleaning section).</p> <p>Improper rack loading. (See Loading section).</p> <p>Choose another cycle to give you longer washing time.</p> |
| DETERGENT LEFT IN DISPENSER CUPS | <p>Water may not be reaching the detergent cups. Move dishes that maybe blocking detergent cup.</p> <p>The dispenser cover may not be opening or may be blocked by improperly loaded items. If you used a powder detergent, open the cup and remove any caked-on detergent. If the cup still doesn't open automatically, cdl for service.</p> <p>Detergent may be old. If the powder detergent is hard or caked in the box, throw it away. The detergent may not be working well. Try another brand.</p> |
| DETERGENT CUP LID WON'T LATCH AFTER ADDING DETERGENT | Cycle Indicator Dial must be OFF for cup lid to close and latch properly. If you unlatch the door and open it to dry your dishes, the Cycle Indicator Dial does not advance by itself. |
| YELLOW OR BROWN FILM | <p>Tea or coffee can stain cups. Remove the stain by hand, using a solution of 1/2 cup bleach and 3 cups warm water.</p> <p>An overall yellow or brown film on dishes or glassware can be caused by iron deposits in water. A special filter in the water supply line is the only way to correct this problem, Your water softener company can tell you about the filter.</p> <p>Yellow film on sterling silver results when you wash copper utensils in the same load. Silver polish will usually remove this stain,</p> |

(continued next page)



THE PROBLEM SOLVER

(continued)

| PROBLEM | POSSIBLE CAUSE |
|--|--|
| SPOTS AND FILMING ON GLASSES AND FLATWARE | <p>Spotting can be caused by all these things:</p> <ul style="list-style-type: none">• Extremely hard water. (See How to Choose and Use Detergent section).• Low inlet water temperature, (See How to Test Water Temperature section),• Overloading the dishwasher.• Improper loading. (See Loading section).• Old or damp powder detergent.• Phosphate level in detergent too low. (See How to Choose and Use Detergent section).• Rinse agent dispenser empty. (See How to Use a Rinse Agent section).• Too little detergent. (See How to Choose and Use Detergent section). <p>Local water conditions and personal preferences vary. Try several brands of detergents to find one that gives the best results for you. A liquid dishwasher detergent may help reduce filming.</p> <p>To remove stubborn spots and film from glassware:</p> <ol style="list-style-type: none">1. Remove all metal utensils from the dishwasher.2. Do not add detergent.3. Select POTSCRUBBER cycle.4. Start the dishwasher and allow to run for 18 to 22 minutes. The dishwasher will now be@ the main wash.5. Then open the door and pour 2 cups (500 ml) of white vinegar into the bottom of the dishwasher.6. Close the door and allow to complete the cycle. <p>If vinegar rinse doesn't work: Repeat as above, except use 1/4 cup {60 ml} of citric acid crystals instead of vinegar. (Most drugstores carry citric acid crystals. If yours doesn't, call GE Factory Service).</p> <p>Using a vinegar or citric acid crystal rinse more than twice a month? Consider a home water softener.</p> |
| CLOUDINESS ON GLASSWARE | <p>If vinegar or citric acid crystal rinse doesn't work, the cloudiness is "etching." The film cannot be removed.</p> <p>It can be prevented: Use less detergent if you have soft water. Wash glassware in the shortest cycle that will get them clean.</p> <p>Water temperature entering dishwasher exceeds 150°F.</p> |
| CHIPPING OF CHINA | <p>Rough handling can cause chipping. Load with care. Make sure glassware and china are secure and can't jar loose. (See Loading section). Make sure tall glasses and stemware will clear the top of the tub when you push the rack into the dishwasher.</p> <p>Always use the top rack for delicate items.</p> |



| PROBLEM | POSSIBLE CAUSE |
|---|--|
| BLACK OR GRAY MARKS ON DISHES | Aluminum utensils often leave marks when they rub against dishes. Remove marks with a mild abrasive cleanser. |
| SMALL AMOUNT OF WATER STANDING IN THE BOTTOM OF THE TUB | Water around the outlet on the tub bottom at the back of the tub is normal . It is clean water. It's there to keep the water seal lubricated. |
| WATER WON'T PUMP OUT OF THE TUB | If the entire bottom of the tub has water, you may have a drain problem. Clean the air gap, if you have one. (See Care and Cleaning section). Check the kitchen sink. Is it draining well? You may need a plumber. If dishwasher drains into disposer, run disposer to clear. Be sure disposer is not clogged. |
| SUDS IN THE TUB | Sudsing detergents are not meant for dishwashers. USE ONLY AUTOMATIC DISHWASHER DETERGENTS TO AVOID SUDSING. To remove suds from the tub: Open the dishwasher. Let suds evaporate. Add 1 gallon of cold water to the tub. Close and latch the dishwasher. Pump out water by slowly turning the control dial until a drain period is reached. Repeat if necessary. |
| DISHWASHER LEAKS | Suds can cause unit to overflow . That's why it's so important to use a detergent that's designed for automatic dishwashers. Spilling the rinse agent can cause foam during washing. This can lead to overflowing . Wipe up accidental spill of rinse agent with a damp cloth. |
| MOTOR HUMS | Dishwasher has not been used on a regular basis. If you do not use your dishwasher often, set it to fill and pump out once every week. This will help keep the seal moist, and the garbage disposer clear. |
| STAINING OF TUB INTERIOR | Some detergents contain colorant (pigment or dyes) that will discolor the tub interior with extended use. Check the detergent cup for signs of any discoloration. If cup is discolored, change to detergent without any colorant. |
| SOUNDS YOU WILL HEAR | You'll hear occasional clicking sounds. These are normal. <ul style="list-style-type: none">• Soft food disposal shredding action.• Drain valve opening to pump water out.• Timer control as cycle progresses. * Detergent cup opening. During the drying period: <ul style="list-style-type: none">• The motor stops. |
| VAPOR AT THE VENT | Water vapor comes through the vent by the door latch during drying and when water is being pumped out. |

If you need more help.. call, toll free:
GE Answer Center®
800.626.2000
consumer information service

NOTES

NOTES

NOTES

YOUR GE DISHWASHER WITH PERMATUF® INTERIOR WARRANTY

Staple sales slip or cancelled check here. Proof of original purchase date is needed to obtain service under warranty.

WHAT IS COVERED

FULL ONE-YEAR WARRANTY

For one year from date of original purchase, we will provide, free of charge, parts and service labor in your home to repair or replace **any part of the dishwasher** that fails because of a manufacturing defect.

FULL TEN-YEAR WARRANTY

For ten years from date of original purchase, we will provide, free of charge, parts and service labor in your home to repair or replace **the PermaTuf® tub or door liner** if it fails to contain water because of a manufacturing defect such as cracking, chipping, peeling or rusting.

LIMITED SECOND-YEAR WARRANTY

For the second year from date of original purchase, we will provide, free of charge, replacement parts for **any part of the Water Distribution System** (as illustrated below) that fails because of a manufacturing defect. Associated inlet and drain plumbing parts are not covered by this warranty. You pay for the service trip to your home and service labor charges.

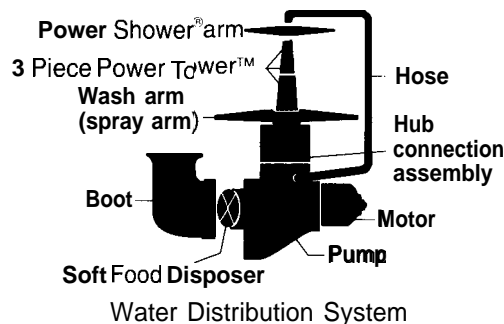

This warranty is extended to the original purchaser and any succeeding owner for products purchased for ordinary home use in the 48 mainland states, Hawaii and Washington, D.C. In Alaska the warranty is the same except that it is LIMITED because you must pay to ship the product to the service shop or for the service technician's travel costs to your home.

All warranty service will be provided by our Factory Service Centers or by our authorized Customer Care® servicers during normal working hours.

Should your appliance need service, during warranty period or beyond, call 800-GE-CARES (800-432-2737).

WHAT IS NOT COVERED

- Service trips to your home to teach you how to use the product.
 - **Read your Use and Care material.** If you then have any questions about operating the product, please contact your dealer or our Consumer Affairs office at the address below, or call, toll free: GE Answer Center™ 800.626.2000 consumer information service
 - Improper installation.
- If you have an installation problem, contact your dealer or installer. You are responsible for providing

- adequate electrical, plumbing, and other connecting facilities.
 - Replacement of house fuses or resetting of circuit breakers.
 - Cleaning or servicing of air gap device in drain line.
 - **Failure of the product if it is used for other than its intended purpose or used commercially.**
 - Damage to product caused by accident, fire, floods or acts of God.
- WARRANTOR IS **NOT** RESPONSIBLE FOR CONSEQUENTIAL DAMAGES.

Some states do not allow the exclusion or limitation of incidental or consequential damages, so the above limitation or exclusion may not apply to you. This warranty gives you specific legal rights, and you may also have other rights which vary from state to state. To know what your legal rights are in your state, consult your local or state consumer affairs office or your state's Attorney General.

Warrantor: General Electric Company

If further help is needed concerning this warranty, write:
Manager—Consumer Affairs, GE Appliances, Louisville, KY 40225

This book is printed on recycled paper.

Part No. 165D3080P317
Pub No. 49-5625

6-93 CG

GSD650
GSD680

Printed in Louisville, KY