

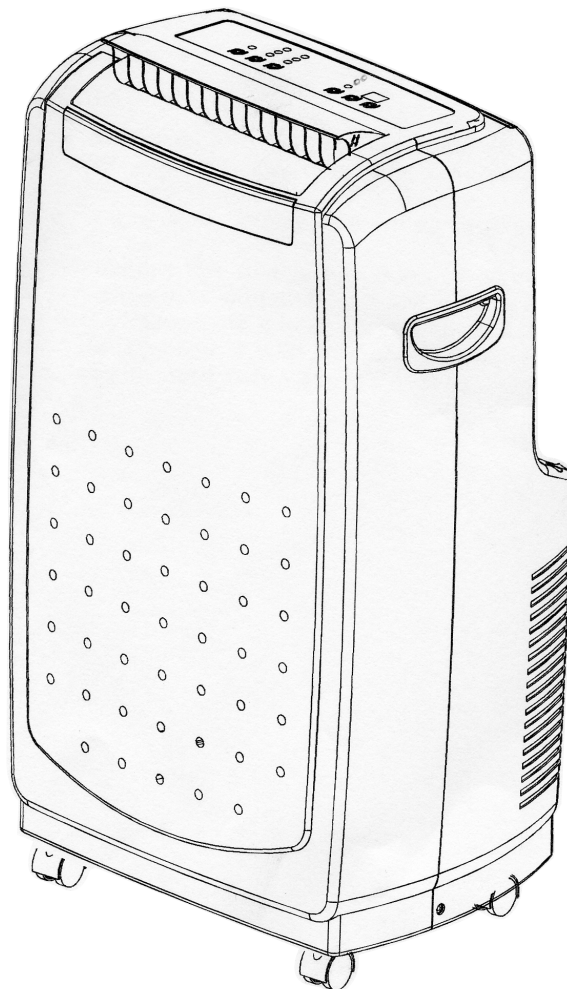

PORTABLE AIR CONDITIONER
CLIMATISEUR PORTATIF
ACONDICIONADOR DE AIRE PORTATIL



Model#
Modèle#
Modelo#

HPRD12XC5
HPRD12HC5

A Word From Haier

Thank You for buying a dependable, energy saving and easy to operate HAIER air conditioner. This manual contains useful information for you to maintain, operate, install and safely use your air conditioner. Your air conditioner cleans, cools and dehumidifies the air in your room to provide you with the ultimate level of comfort.

Please read instructions carefully before using the product. Also, do not forget to fill out and mail the **Product Registration Card**.

Product Registration

Record Your Model and Serial Number.

For all your service calls during the warranty period the following information will be needed. Attach the sales receipt to this guide and keep for future reference. This information can be obtained from the serial plate, which is on your air conditioner.

Model Number:





Serial Number:

Date of Purchase:

Dealer's Name:

Dealers Address:

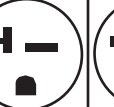
Dealers Phone Number:

TABLE					
RECEPTACLE AND FUSE TYPES					
RATED VOLTS	125/60		250/60		
AMPS	15	20	15	20	30
WALL OUTLET					
FUSE SIZE	15	20*	15	20*	30
TIME DELAY FUSE (or circuit breaker)	Plug	Plug	Plug		

SAFETY PRECAUTIONS



WARNING: Following these basic precautions will reduce the risk of fire, electrical shock, injury or death when using your air conditioner.

- 1) Air conditioner must be connected to proper electrical outlet with the correct electrical supply. (see table)
- 2) Proper grounding must be ensured to reduce the risk of shock and fire. **DO NOT CUT OR REMOVE THE GROUNDING PRONG.** If you do not have a three-prong electric receptacle outlet in the wall, have a certified electrician install the proper receptacle. The wall receptacle **MUST** be properly grounded.
- 3) Do not operate air conditioner if power cord is frayed or otherwise damaged. Also avoid using it if there are cracks or abrasion damage along the length, plug connector or if the unit malfunctions or is damaged in any manner. Contact an authorized service for examination, repairs or adjustments.
- 4) **DO NOT USE AN ADAPTER OR AN EXTENSION CORD.**
- 5) Do not block airflow around the air conditioner. Also the exhaust hose should be free of any obstructions.
- 6) Always unplug the air conditioner before servicing it or moving it.
- 7) Do not install or use the air conditioner in any area where the atmosphere contains combustible gases or where the atmosphere is oily or sulphurous. Avoid any chemicals coming in contact with your air conditioner.
- 8) Do not place any object on the top of the unit.
- 9) Never operate the air conditioner without the filters in place.
- 10) Do not use the air conditioners near a bathtub, shower or wash basin.

Table Of Contents

	PAGE
A Word From Haier	1
Product Registration	1
Safety Precautions	2
Advantages	4
Parts and Features	5
Assembly and Installation	6
Operation	9
Product Specification	12
Care and Cleaning	12
Storage	12
Trouble Shooting	13
Warranty Information	14

Advantages of this Model

1. Unique dual-hose design, providing more powerful and faster cooling than the single-hose design.
2. Adjustable airflow direction for convenient and effective cooling.
3. Heat and cool functions for HPRD12XH5.
4. This model is easy to operate. The electronic control panel has a timer, thermostat, three speed cooling speeds, three fan speeds and one speed dehumidification function (dry).
5. This portable air conditioner does not require water to be added.
6. The unit has a unique design which evaporates the water. Therefore no condensation tank is necessary, thus avoiding you to have to wake up in the middle of the night to empty the bucket and turn on the unit.
7. Easy to install window kit is included which consists of the, exhaust hose, 2 hose nozzle, the window panel kit, exhaust hose connector and cover for the exhaust hose connector.
8. Full directional casters are included to help to move the unit to be conveniently used in almost any area.
9. The filter screen is designed for easily accessibility of the filter.
10. Portable air conditioners are easy to store when not in use.

Parts and Features

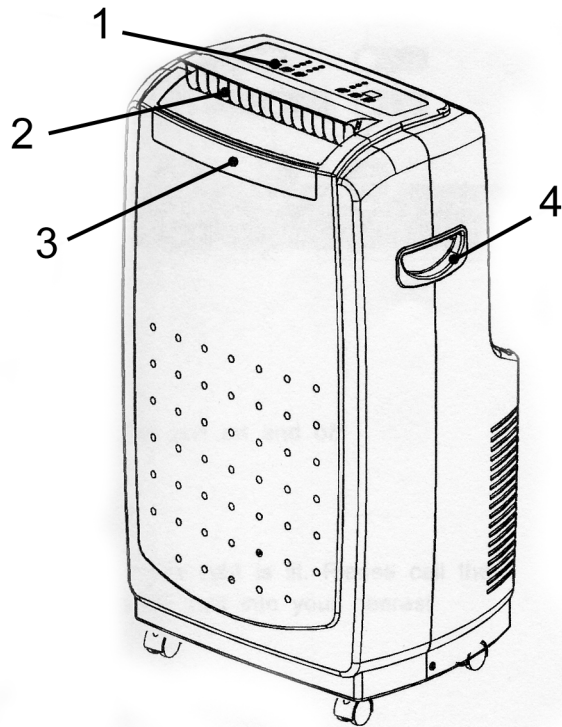

- 1. Control Panel
- 2. Cold Air Outlet
- 3. Signal Receptor
- 4. Transport Handle
- 5. Air Outlet Hose
- 6. Evaporator Air Intake
- 7. Air Intake Hose
- 8. Drain Port
- 9. Power Supply

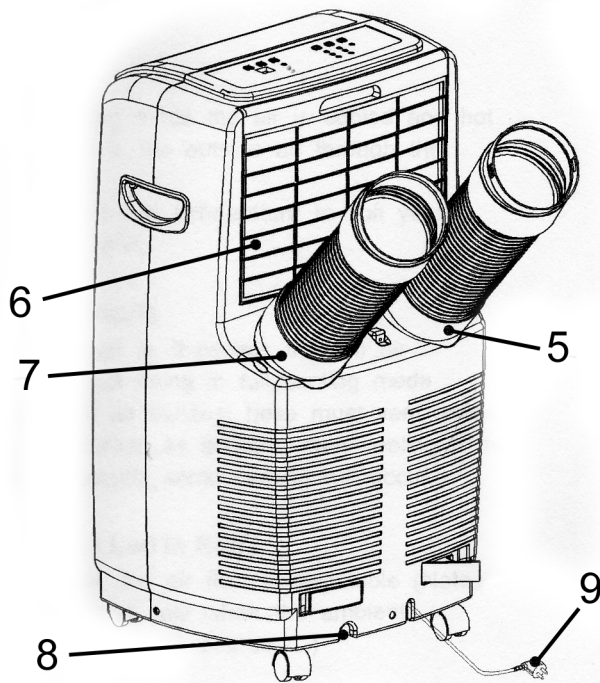

Fig. 1

Assembly and Installation

Assembly Instruction

A. Connect exhaust hose to the back of the unit. Extend hose to desired length and connect with window kit.

USING EXHAUST DUCT SET

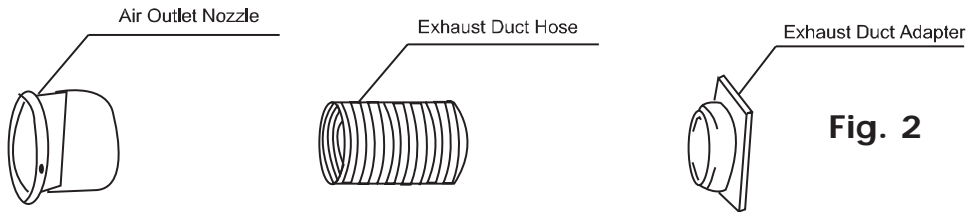

Fig. 2

1. Insert ends of Exhaust hose into air outlet nozzle and Exhaust duct "A" by twisting until it stops.
2. Fix the Exhaust duct "A" to the exhaust outlet on the rear of the unit. This is achieved by sliding the appropriate connector downward over the exhaust outlet ensuring that the lugs on the outlet are engaged with the grooves on the connector.
3. The exhaust hose is snap-fit to the unit. To take it off, turn it clockwise and remove.

Note: Air outlet hose should be mounted at right side (see fig. 1)

4. Extend the Exhaust hose and close the Window as far as possible trapping the air outlet nozzle.

B. Repeat same steps for the air intake hose.

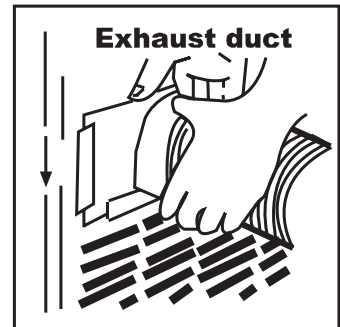
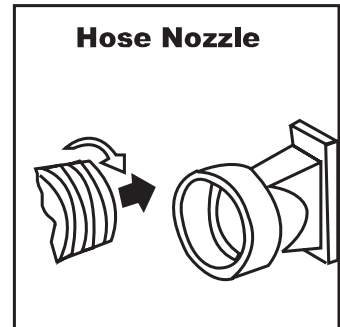

Window Kit Installation

USING WINDOW PANEL KIT

1. Air Inlet Hose - 1 set
2. Air Outlet Hose - 1 set
3. Window Exhaust Adapter - 2 pieces
4. Window/Patio Door Slider Kit - 1 set

①

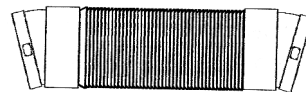

③

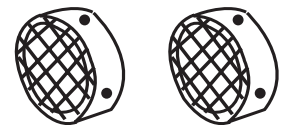

②

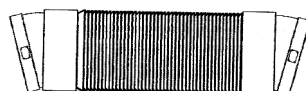

④

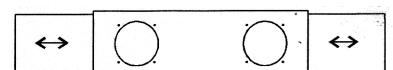

Your window kit has been designed to fit most standard vertical and horizontal window applications. However, it may be necessary for you to improvise/modify some aspects of the installation procedures for certain type windows. Please refer to for minimum and maximum window openings.

Note: Window kit is just available for some models.

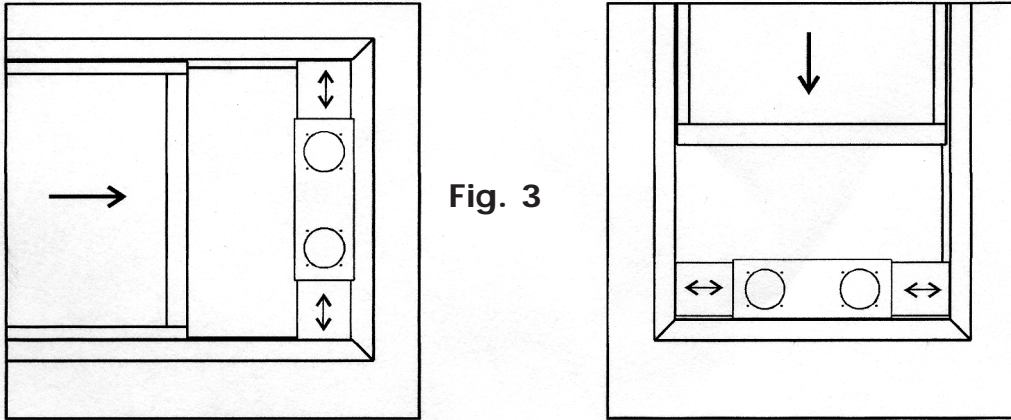

Fig. 3

Installation Instruction

- Air outlet intake indoor side can not be blocked by curtains, or something alike.
- The end of air hose cannot be blocked by shutters or something alike.
- Do not bend the air hose when assembling, keep it straight.
- When appliance in cool or dry mode, condensate will concentrate in water box of chassis. When the box is full, water full indicator glitters (red), LCD window appears the error sign E. The appliance will stop running at the same time. Now the power supply should be shut, then pull out the rubber plug in drain port underside the appliance, drain the water into a prepared container, or drain the water by moving the appliance to a suitable place.

Note: Water should be drained out when the water full light is on. Otherwise, the appliance will not work.

- Select the Best Location where there is beside the window, the door or the French window.
- Keep the required distance from the return air outlet to the wall or other obstacles at least 20".
- Fix one end of the air hose on the air intake or outlet underside the appliance.
- Extend the air hose to insure another end of the air hose be taken in the clearance between window, door, or French window, or wall hole.
- Air outlet or intake can not be blocked by protective grid or something alike.
- The distance between two ends of the air hose should be kept at 8" at least.

Note: The cooling capacity will decrease when using a single air hose.

Installation Sequence

Before Starting this Unit

1. Select a suitable location, making sure you have easy access to an electrical outlet.
2. Install the flexible exhaust hose and adjustable window slider kit as depicted in Fig. 2 & 3.

Note: 1. Step 2 is required only while using cooling or dry mode, in cooling mode you can select to install two hoses or air outlet hose only, in dry mode you may install air outlet hose only.

2. While running or installing the hoses cannot be blocked by curtains and so on.

3. Plug the appliance into a grounded electrical outlet. Please select an appropriate power supply basis the nameplate.

Note: Do not use a regular extension cord.

4. To turn the appliance on, press ON/OFF button.

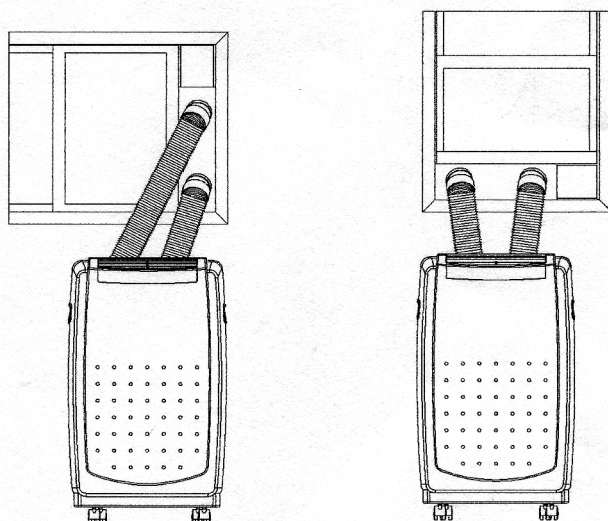

Operation

NOTE: Wait for 24 hours to turn on air conditioner if the unit has been tilted for any reason. This is for the oils and the coolants to settle and level off.

1. Wait for 3 minutes before restarting the unit after a normal shut down so as to complete the compressor cycle.
2. Use an 115v 15 amp outlet for the air conditioner. Do not use any other electrical appliances on this line or you may trip the fuse. Use a dedicated line for this air conditioner.
3. Do not place the air conditioner in direct sunlight or close to any heating appliances.
ex. baseboard heaters, stoves, etc.
4. Operate on a flat surface only.
5. Keep the unit free of any obstructions such as drapes, curtains, blinds, etc.
6. Keep unit at least 1 foot away from the wall.
7. Check and clean the filter once every week to get the highest efficiency.

NOTE: Do not use unit without filter.

8. If the unit is not being used for a long period of time remove the plug from the water drain pipe and drain out any condensed water.

When turning on the unit first time after plugging it into an electrical outlet the unit will start in a low fan cool mode. The temperature read out on the LED will be the room temperature. When turning on the unit in regular usage it will remember the last shut off setting.

Control Panel

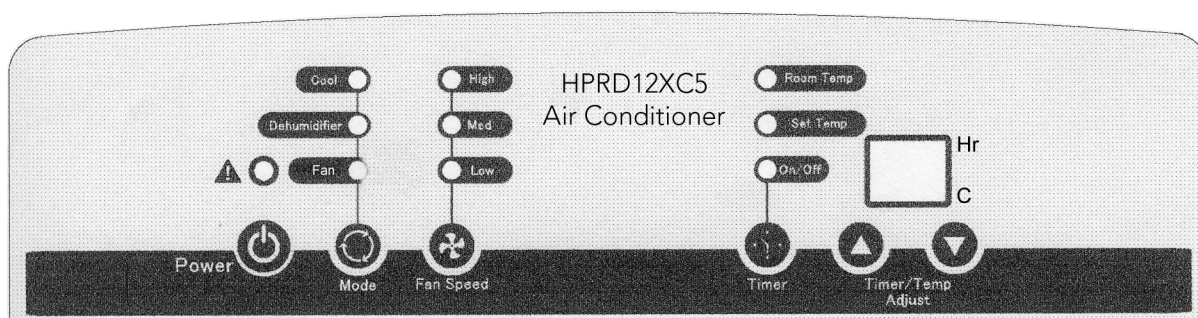
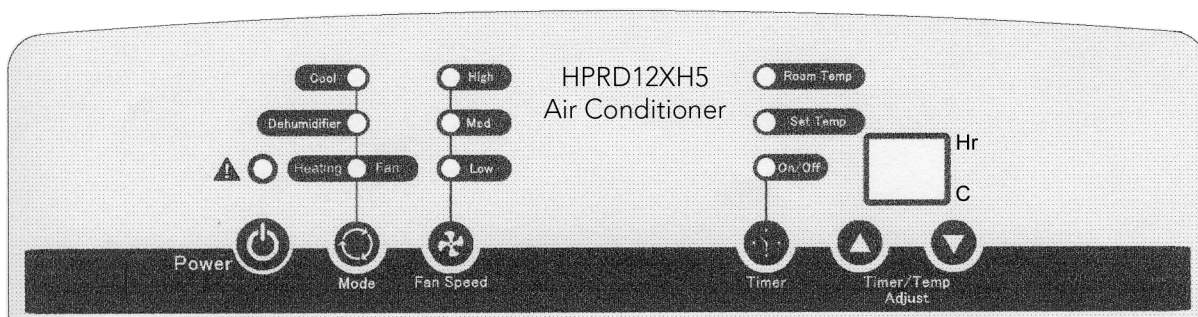

Power Control

The power control turns the unit on and off.

Warning Light

Do not operate the unit if this light is lit. Please call the service number and bring the unit into your nearest service center.

Mode Control

The mode control has 3 settings:

- **Cool** • **Dehumidifier**
- **Heating** (only HPRD12XH5)/**Fan**

The settings are adjusted with Mode Control button. A green light will indicate which setting is currently being used.

Cooling Mode

- During the cooling mode the air is cooled and hot air is exhausted to the outside air through the exhaust tube.
- Adjust fan speed and temperature to suit your desired comfort level.

Dehumidifier Mode

- Air is dehumidified as it passes through the air conditioner, without being in full cooling mode. (Note: The warm air exhaust hose must vent inside the room, not outside as it does when cooling. If the unit is vented outside some cooling will occur.)

Heating Mode (Led in Red)

(only HPRD12XH5)

- In heating mode, the air flow is selectable. (Note: Heating is activated only when the ambient temperature is below 77° F.)

Fan Mode (Led in Yellow)

- Air is circulated throughout the room with no cooling. (Note: Unit does not need to be vented in Fan mode.)

Fan Speed

The Fan Speed Control has three settings: High, Medium or Low. In the Dehumidifier or Dry Mode, the fan will only operate at low speed.

Timer

Auto turn off:

With machine in fan mode, press timer button to select number of hours you would like the unit to run in air conditioning mode until automatically shuts off.

Auto turn on:

With machine powered off, press timer button to select number of hours until you would like the unit to automatically start running in air conditioning mode.

Timer / Temperature Buttons

- Used for adjusting the timer and thermostat.
- The default display is room temperature.
- When "▲" or "▼" button is pressed, the set temperature is displayed and may be adjusted. After 15 seconds the display will revert back to room temperature.
- The temperature can be raised or lowered in the cool and dehumidifier or dry mode. The temperature cannot be adjusted in the fan mode.

Remote Control

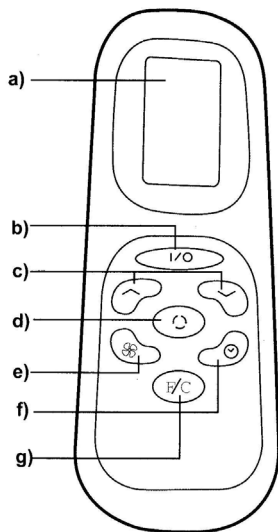

- a) LCD Screen
- b) Power On/Off Button
- c) Timer and Thermostat Setting Buttons
- d) Mode Button (Select A/C, Fan or Dehumidifier)
- e) A/C Fan Speed Button (High, Medium, or Low)
- f) Timer On/Off Button
- g) Fahrenheit/Celsius Selector

TIMER PROGRAMMING

1. Press the (⌚) button on the remote or the "Timer Setting" button on the control panel to turn on the Timer Function.
2. Press the (∧) or (∨) buttons on the remote or the (▲) or (▼) buttons on the control panel to set the desired shut-off period.
3. The unit will shut off when the set time elapses.

DEHUMIDIFICATION OPERATION

Press the (☁) button on the remote or the "MODE" button on the control panel to select the dehumidifier mode. When the dehumidifier mode is on, the temperature buttons and the fan speed buttons do not function and the fan will operate on low speed. The dehumidifier indicator light will illuminate and stay solid while the unit is dehumidify, and the dehumidifier light will blink. Remember, the exhaust hose does not need to be used in dehumidifier mode.

Air Conditioner Remote Control

The functions work the same as your air conditioner's touch controls.

Batteries: remove the cover on the back of the remote controller and insert the batteries with the (+) and (-) poles pointing in the proper direction.

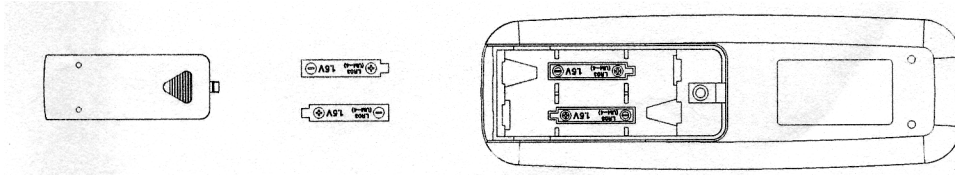

CAUTION

Use only AAA or IEC R03 1.5V batteries.

Remove the batteries if the remote controller is not used for a month or longer.

Do not attempt to recharge the supplied batteries.

All batteries should be replaced at the same time.

Do not dispose of the batteries in a fire as they may explode.

Product Specification

Voltage and Frequency	115V / 60Hz
Input Power (cooling/heating)	1,250 / 1,450 W
Cooling Capacity	12,000 BTU
Heating Capacity	6,200 BTU (HPRD12XH5 only)
Moisture Removal (pints/day)	85.0
Coolant	R22 / 1.67 lbs
Timer	12 Hours
Operating Temperature Range	61°F - 100°F
Unit Dimensions (WxDxH) (inches)	18 9/16 x 15 9/16 x 34 3/16
Net Weight lbs. approximate	70.4 lbs.
Power Cord	84"
Exhaust Hose	5 Feet

Care and Cleaning Guide

- Always unplug your air conditioner before cleaning.
- Air filter needs to be cleaned at least once a week for your unit to operate at optimum efficiency. The filter can be slid out from the back by pulling on the tab. The filter may be washed or vacuumed. Remove the excess water from the filter by gently shaking the filter. This will remove dust and particles trapped in the filter. After cleaning, reinstall the filter. **DO NOT** use your air conditioner without the air filter in place.
- To clean the cabinet **DO NOT** use harsh chemicals, abrasives, ammonia, chlorine, bleach, concentrated detergents, solvents or metal scouring pads. Some of these chemicals may dissolve, damage and/or discolor your air conditioner.
- Always use a soft cloth dampened with water or mild soap and water solution to wipe the front of the cabinet. Wipe dry with a soft cloth.

Storage

- To store your air conditioner when not being used for a long period of time, drain condensed water using the drain pipe. Remove exhaust hose, clean filters, cover with plastic bag and store away.

Trouble-Shooting

If air conditioner does not operate:

- Check if unit is plugged in. The plug may have come loose.
- Check if the electrical wall receptacle is of proper voltage.
- Check if the circuit breaker needs to be reset or if the fuse needs to be replaced.
- Check if the unit is in "Off" mode.
- The tank full warning light is on. Call for service.

Air conditioner working but room not cooling:

- Room may have appliances that produce heat. Use an exhaust fan to remove excess heat.
- Check exhaust hose for proper installation.
- Redirect the airflow. Remove any obstacles.
- All doors and windows need to be closed so cool air does not escape the room.
- Air filter may be blocked or may need cleaning.
- Unit BTU may be too low for the required cooling area.
- On extreme hot & humid days air conditioners may take a little longer to cool.
- Drain the water drain pipe by removing the plug.
- Unit may be in fan or dry mode. Put air conditioner in cool mode.

Limited Warranty

This warranty covers all defects in workmanship or materials for:

1. The mechanical and electrical parts (including labor costs) contained in this Haier product, for a period of 12 months, from the date of purchase, (commercial or rental application, the warranty is 90 days).
2. The sealed system and compressor contained in this Haier product is for a period of 5 years, from the date of purchase (excluding labor costs after the initial 12 month period). In commercial or rental use, the additional limited compressor warranty is for 1 year and 9 months, (excluding labor costs after the initial 90 days period).

You must keep and be able to provide your original sales receipt as proof of the date of purchase.

Who is covered?

The original retail purchaser of this Haier product.

What will be done?

Haier will repair or replace, in your home, any mechanical, electrical part or the compressor, which proves defective in normal household, use for a period of 12 months. Haier will repair or replace (excluding labor costs) the sealed system and compressor (parts only) for an additional 4 year period.

How can you get service?

1. Contact your nearest Haier authorized Service Depot. For the name of the Service Depot nearest you, contact Haier at (877) 337-3639.
2. All service must be performed, by an authorized Haier Service Depot.

THIS WARRANTY COVERS UNITS WITHIN THE CONTINENTAL UNITED STATES, CANADA AND PUERTO RICO AND DOES NOT COVER:

- Damages from improper installation
- Damages in shipping
- Damages from misuse, abuse, accident, alteration, lack of proper care and maintenance
- Damages from service, by other than an authorized dealer or service center
- Labor, service, transportation and shipping charges for the removal of defective parts and installation of a replacement part, beyond the initial 12 month period.

THIS LIMITED WARRANTY IS GIVEN IN LIEU OF ALL OTHER WARRANTIES, EXPRESS OR IMPLIED, INCLUDING THE WARRANTIES OF MERCHANTABILITY AND FITNESS FOR A PARTICULAR PURPOSE.

The remedy provided in this warranty is exclusive and is granted in lieu of all other remedies. This warranty does not cover incidental or consequential damages. Some states do not allow the exclusion of incidental or consequential damages, so this limitation may not apply to you. Some states do not allow limitations on how long an implied warranty lasts, so this limitation may not apply to you. This warranty gives you specific legal rights, and you may also have other rights, which vary from state to state.