

This Owner's Manual is provided and hosted by [Appliance Factory Parts](#).



# Haier MWM10100SS Owner's Manual

[Shop genuine replacement parts for Haier  
MWM10100SS](#)



[Find Your Haier Microwave Parts - Select From 110 Models](#)

----- Manual continues below part list -----

## Available Replacement Parts for Haier MWM10100SS

<a href="#">WB26X10252</a>	TRAY MOTOR
<a href="#">WB48X30612</a>	GLASS TRAY
<a href="#">WB06X10861</a>	COUPLER

# 1.0 Cu.Ft. / 1000 Watt Microwave Oven

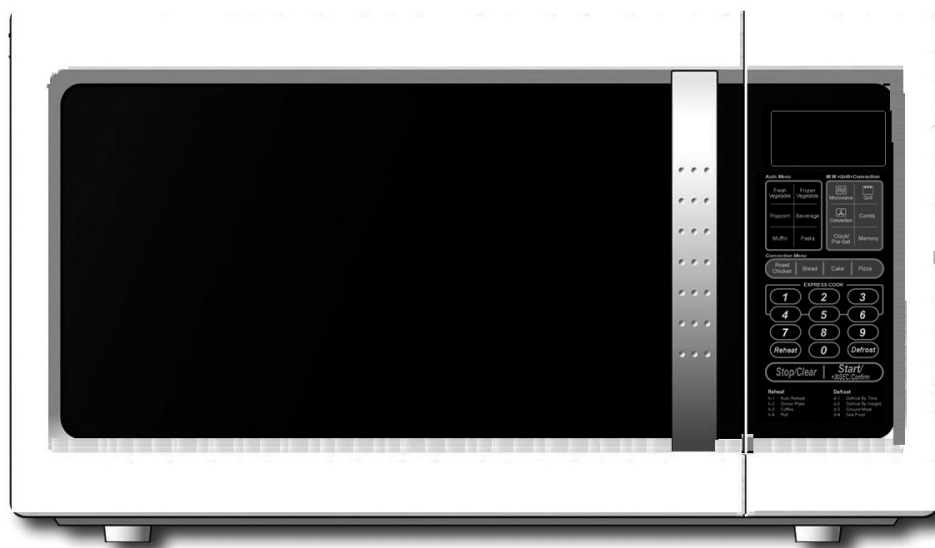

Read these instructions carefully before using your microwave oven, and keep it carefully. If you follow the instructions, your oven will provide you with many years of good service.

Owner's Manual  
MWM10100SS

# Haier

Quality · Innovation · Style

## PRECAUTIONS TO AVOID POSSIBLE EXPOSURE TO EXCESSIVE MICROWAVE ENERGY

- (a) Do not attempt to operate this oven with the door open since this can result in harmful exposure to microwave energy. It is important not to break or tamper with the safety interlocks.
- (b) Do not place any object between the oven front face and the door or allow soil or cleaner residue to accumulate on sealing surfaces.
- (c) Do not operate the oven if it is damaged. It is particularly important that the oven door closes properly and that there is no damage to the:
  - (1) DOOR (bent)
  - (2) HINGES AND LATCHES (broken or loosened)
  - (3) DOOR SEALS AND SEALING SURFACE
- (d) The oven should not be adjusted or repaired by anyone except properly qualified service personnel.

## ADDENDUM

If the apparatus is not maintained in a good state of cleanliness, its surface could be degraded and affect the lifespan of the apparatus and lead to a dangerous situation.

## Specifications

Model:	MWM11100T
Rated Voltage:	120V~ 60Hz
Rated Input Power(Microwave):	1450W
Rated Output Power(Microwave):	1000W
Oven Capacity:	0.9 Cu.ft.
Turntable Diameter:	Ø12.40 inch
External Dimensions (WxHxD):	20.5•17.5•13.2 inch
Net Weight:	Approx. 33.5 Lbs
Warning:	Handling the cord on this press or cords associated with accessories sold with this product, will expose you to lead a chemical known to the state of California to cause cancer, and birth defects or other reproductive harm. Wash hands after handle.

# CONTENTS

	<b>PAGE</b>
<b>PRECAUTIONS TO AVOID POSSIBLE EXPOSURE TO EXCESSIVE MICROWAVE ENERGY</b> .....	1
<b>SPECIFICATIONS</b> .....	1
<b>IMPORTANT SAFETY INSTRUCTIONS</b> .....	3
<b>ADDITIONAL SAFETY TIPS</b> .....	4
<b>GROUNDING INSTRUCTIONS</b> .....	4
<b>UTENSILS GUIDE</b> .....	5
Materials you can use in microwave oven .....	5
Materials to be avoided in microwave oven .....	6
<b>SETTING UP YOUR OVEN</b> .....	6-8
Names of Oven Parts and Accessories .....	6
Turntable Installation .....	7
Countertop Installation .....	7
Installation .....	7
<b>OPERATION</b> .....	8-15
Control Panel and Features .....	8
Operating Instructions .....	9-15
<b>TROUBLE SHOOTING</b> .....	16
<b>LIMITED WARRANTY</b> .....	17

## IMPORTANT SAFETY INSTRUCTIONS

When using electrical appliances, basic safety precautions should be followed, including the following:

**WARNING** - To reduce the risk of burns, electric shock, fire, injury to persons or exposure to excessive microwave energy:

1. **Read all instructions before using the appliance.**
2. Read and follow the specific "PRECAUTIONS TO AVOID POSSIBLE EXPOSURE TO EXCESSIVE MICROWAVE ENERGY" on page 1.
3. This appliance must be grounded. Connected only to properly grounded outlet. See "GROUNDING INSTRUCTIONS" on page 5.
4. Install or locate this appliance only in accordance with the provided installation instructions on page 8.
5. Some products such as whole eggs and sealed containers, for example, closed glass jars may explode and should not be heated in this oven.
6. Use this appliance only for its intended use as described in this manual. Do not use corrosive chemicals or vapors in this appliance. This type of oven is specifically designed to heat, cook or dry food. It is not designed for industrial or laboratory use.
7. As with any appliance, close supervision is necessary when used by children.
8. To reduce the risk of fire in the oven cavity:
  - a. Do not overcook food. Carefully attend appliance if paper, plastic or other combustible materials are placed inside the oven to facilitate cooking.
  - b. Remove wire twist-ties from paper or plastic bags before placing bag in oven.
  - c. If materials inside the oven should ignite, keep oven door closed, turn oven off, and disconnect the power cord or shut off power at the fuse or circuit breaker panel.**
  - d. Do not use the cavity for storage purposes. Do not leave paper products, cooking utensils or food in the cavity when not in use.
9. Liquids, such as water, coffee, or tea are able to be overheated beyond the boiling point without appearing to be boiling. Visible bubbling or boiling when the container is removed from the microwave oven is not always present. THIS COULD RESULT IN VERY HOT LIQUIDS SUDDENLY BOILING OVER WHEN THE CONTAINER IS DISTURBED OR A UTENSIL IS INSERTED INTO THE LIQUID.
10. Do not deep fry food in the microwave. It is difficult to control the fat which could cause a fire hazard.
11. Pierce foods with heavy skins such as potatoes, whole squash, apples and chestnuts before cooking.
12. The contents of feeding bottles and baby jars should be stirred or shaken and the temperature should be checked before serving in order to avoid burns.
13. Cooking utensils may become hot because of heat transferred from the heated food. Potholders may be needed to handle the utensil.
14. Do not cover or block any openings on the appliance.
15. Do not store or use this appliance outdoors. Do not use this product near water, for example, near a kitchen sink, in a wet basement, or near a swimming pool, and the like.
16. Do not operate this appliance if it has a damaged cord or a plug, if it is not working properly or if it has been damaged or dropped.
17. Do not immerse cord or plug in water. Keep cord away from heated surface. Do not let cord hang over edge of table or counter.
18. Use only thermometers which are specifically designed for use in microwave ovens.
19. When cleaning surfaces or door and oven that comes together on closing the door, use only mild, nonabrasive soaps, or detergents applied with a sponge or soft cloth.
20. Be certain the glass tray and roller ring are in place when you operate the oven.
21. This appliance should be serviced only by qualified service personnel. Contact nearest authorized service facility for examination, repair, or adjustment.

**SAVE THESE INSTRUCTIONS**

## ADDITIONAL SAFETY TIPS

1. The oven must be on a leveled surface.
2. The turntable and turntable roller rest must be in the oven during cooking. Place the cookware gently on the turntable and handle it carefully to avoid possible breakage.
3. Incorrect use of browning dish may cause the turntable to break.
4. Use only the specified bag size when using Direct Access Popcorn.
5. The oven has several built-in safety switches to ensure that the power remains off when the door is open. Do not tamper with these switches.
6. Do not operate the microwave oven empty. Operating the oven with no food or food that is extremely low in moisture can cause fire, charring or sparking.
7. Do not cook bacon directly on the turntable. Excessive local heating of the turntable may cause the turntable to break.
8. Do not heat baby bottles or baby food in the microwave oven. Uneven heating may occur and could cause physical injury.
9. Do not heat narrow-necked containers, such as syrup bottles.
10. Do not attempt to deep-fry in your microwave oven.
11. Do not attempt home canning in this microwave oven, as it is impossible to be sure all contents of the jar have reached boiling temperature.
12. Do not use this microwave oven for commercial purpose. This microwave oven is made for household use only.
13. To prevent delayed eruptive boiling of hot liquids and beverages or scalding yourself, stir liquid before placing the container in the oven and again halfway through cooking time. Let stand in the oven for a short time and stir again before removing the container.
14. Use carefully when cooking food in the microwave oven to avoid burning due to excessive cooking.
15. When the appliance is operated in the combination mode, children should only use the oven under adult supervision due to the temperatures generated.
16. Failure to maintain the oven in a clean condition could lead to deterioration that could adversely affect the life of the appliance and possibly result in a hazardous situation.

## GROUNDING INSTALLATION

**DANGER:** Electric Shock Hazard Touching some of the internal components can cause serious personal injury or death. Do not disassemble this appliance.

**WARNING:** Electric Shock Hazard Improper use of the grounding can result in electric shock. Do not plug into an outlet until appliance is properly installed and grounded.



### Three-Pronged (grounding) Plug

This appliance must be grounded. In the event of an electrical short circuit, grounding reduces the risk of electric shock by providing an escape wire for the electric current. This appliance is equipped with a cord having grounding wire with a grounding plug. The plug must be plugged into an outlet that is properly installed and grounded.

Consult a qualified electrician or serviceman if the grounding instructions are not completely understood or if doubt exists as to whether the appliance is properly grounded.

We do not recommend to use an extension cord.

If it is necessary to use an extension cord, use only a 3-wire extension cord that has a 3 blade grounding plug and a 3-slot receptacle that will accept the plug on the microwave oven. The marked rating of the extension cord shall be equal to or greater than the electrical rating of the appliance.

The longer cord should be arranged so that it will not drape over the countertop or tabletop where it can be pulled on by children or tripped over unintentionally.

Neither Haier nor the dealer can accept any liability for damage to the oven or personal injury resulting from failure to observe the electrical connection procedures.

## UTENSILS

### CAUTION

#### Personal Injury Hazard

Tightly-closed utensils could explode. Closed containers should be opened and plastic pouches should be pierced before cooking.

See the instructions on "Materials you can use in microwave oven or to be avoided in microwave oven."

There may be certain non-metallic utensils that are not safe to use for microwaving. If in doubt, you can test the utensil in question following the procedure below.

#### Utensil Test:

1. Fill a microwave-safe container with 1 cup of cold water (250ml) along with the utensil in question.
2. Cook on maximum power for 1 minute.
3. Carefully feel the utensil. If the empty utensil is warm, do not use it for microwave cooking.
4. Do not exceed 1 minute cooking time.

### Materials you can use in microwave oven

#### Utensils Remarks

Aluminum foil	Shielding only. Small smooth pieces can be used to cover thin parts of meat or poultry to prevent overcooking. Arcing can occur if foil is too close to oven walls. The foil should be at least 1 inch (2.5cm) away from oven walls.
Browning dish	Follow manufacturer's instructions. The bottom of browning dish must be at least 3/16 inch (5mm) above the turntable. Incorrect usage may cause the turntable to break.
Dinnerware	Microwave-safe only. Follow manufacturer's instructions. Do not use cracked or chipped dishes.
Glass jars	Always remove lid. Use only to heat food until just warm. Most glass jars are not heat resistant and may break.
Glassware	Heat-resistant oven glassware only. Make sure there is no metallic trim. Do not use cracked or chipped dishes.
Oven cooking bags	Follow manufacturer's instructions. Do not close with metal tie. Make slits to allow steam to escape.
Paper plates and cups	Use for short-term cooking/warming only. Do not leave oven unattended while cooking.
Paper towels	Use to cover food for reheating and absorbing fat. Use with supervision for a short-term cooking only.
Parchment paper	Use as a cover to prevent splattering or a wrap for steaming.
Plastic	Microwave-safe only. Follow the manufacturer's instructions. Should be labeled "Microwave Safe". Some plastic containers soften, as the food inside gets hot. "Boiling bags" and tightly closed plastic bags should be slit, pierced or vented as directed by package.
Plastic wrap	Microwave-safe only. Use to cover food during cooking to retain moisture. Do not allow plastic wrap to touch food.
Thermometers	Microwave-safe only (meat and candy thermometers).
Wax paper	Use as a cover to prevent splattering and retain moisture.

## Materials to be avoided in microwave oven

### Utensils Remarks

Aluminum tray	May cause arcing. Transfer food into microwave-safe dish.
Food carton with metal handle	May cause arcing. Transfer food into microwave-safe dish.
Metal or metal-trimmed utensils	Metal shields the food from microwave energy. Metal trim may cause arcing.
Metal twist ties	May cause arcing and could cause a fire in the oven.
Paper bags	May cause a fire in the oven.
Plastic foam	Plastic foam may melt or contaminate the liquid inside when exposed to high temperature.
Wood	Wood will dry out when used in the microwave oven and may split or crack.

## SETTING UP YOUR OVEN

### Names of Oven Parts and Accessories

Remove the oven and all materials from the carton and oven cavity.

Your oven comes with the following accessories:

Glass tray	1
Turntable ring assembly	1
Instruction Manual	1

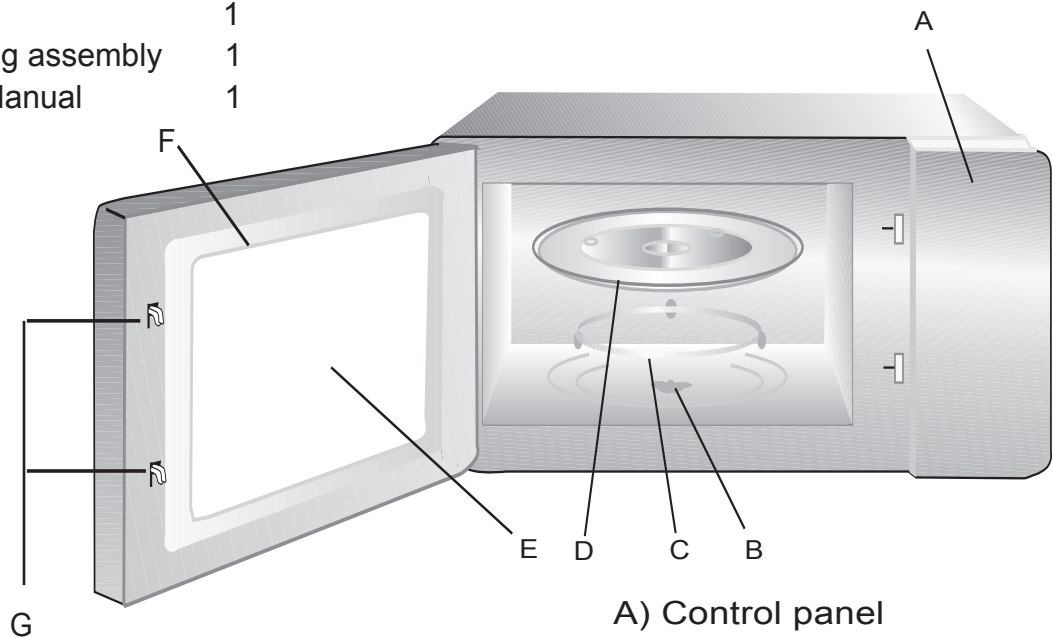

- A) Control panel
- B) Turntable shaft
- C) Turntable ring assembly
- D) Glass tray
- E) Observation window
- F) Door assembly
- G) Safety interlock system

## Turntable Installation

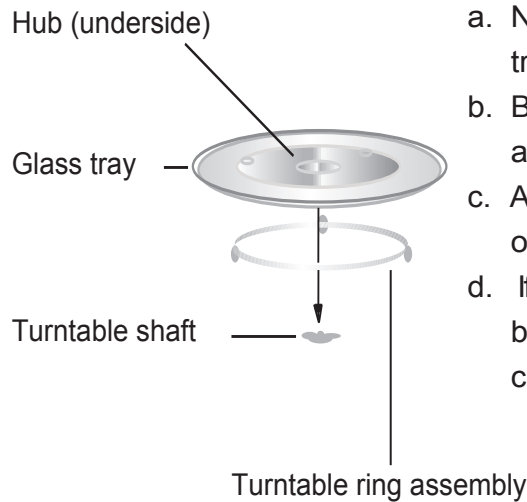

- Never place the glass tray upside down. The glass tray should never be restricted.
- Both glass tray and turntable ring assembly must always be used during cooking.
- All food and containers of food are always placed on the glass tray for cooking.
- If glass tray or turntable ring assembly cracks or breaks, contact your nearest authorized service center.

## Countertop Installation

Remove all packing material and accessories. Examine the oven for any damage such as dents or broken door. Do not install if oven is damaged.

Cabinet: Remove any protective film found on the microwave oven cabinet surface. Do not remove the light brown Mica cover that is attached to the oven cavity to protect the magnetron.

## Installation

- Select a level surface that provide enough open space for the intake and/or outlet vents.

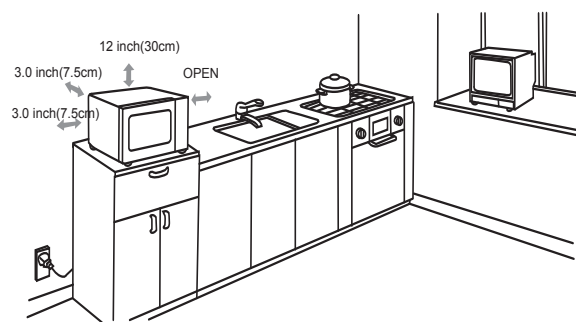

A minimum clearance of 3.0 inches (7.5cm) is required between the oven and any adjacent walls. One side must be open.

- Leave a minimum clearance of 12 inches (30cm) above the oven.
- Do not remove the legs from the bottom of the oven.

- Blocking the intake and/or outlet openings can damage the oven.
- Place the oven as far away from radios and TV as possible. Operation of microwave oven may cause interference to your radio or TV reception.
- Plug your oven into a standard household outlet. Be sure the voltage and the frequency is the same as the voltage and the frequency on the rating label.

**WARNING:** Do not install oven over a range cooktop or other heat-producing appliance. If installed near or over a heat source, the oven could be damaged and the warranty would be void.

# OPERATION

## Control Panel and Features

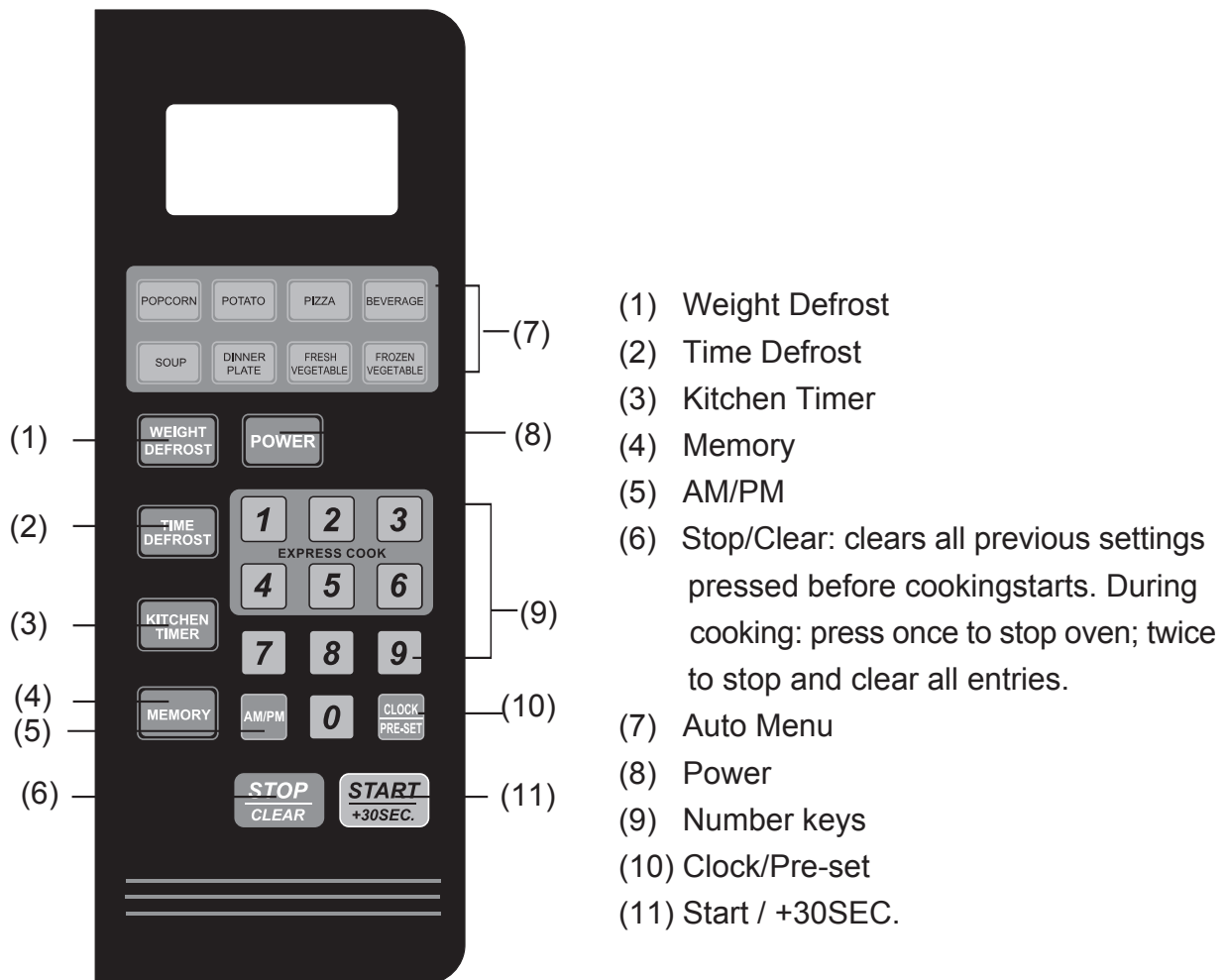

- (1) Weight Defrost
- (2) Time Defrost
- (3) Kitchen Timer
- (4) Memory
- (5) AM/PM
- (6) Stop/Clear: clears all previous settings pressed before cooking starts. During cooking: press once to stop oven; twice to stop and clear all entries.
- (7) Auto Menu
- (8) Power
- (9) Number keys
- (10) Clock/Pre-set
- (11) Start / +30SEC.

# OPERATION

## 1. Power Level

Ten power levels are available.

Level	10	9	8	7	6	5	4	3	2	1
Power	100%	90%	80%	70%	60%	50%	40%	30%	20%	10%
Display	PL10	PL9	PL8	PL7	PL6	PL5	PL4	PL3	PL2	PL1

Remarks: when a power between level 10-8 is chosen, the high level indicator is lighted and it will flash when in operation.  
When a power between level 7-1 is chosen, the low level indicator is lighted and it will flash when in operation.

## 2. Clock Setting

When the microwave oven is plugged into a outlet, the oven will display " 0:00 "

- (1) Press " CLOCK/PRE-SET ", LED will display 00:00, clock indicator will be lighted. The hour figures will flash; ":" and "0" will be lighted.
- (2) Press the number keys and enter the correct time. For example, time is 10:12 now, please press "1,0,1,2" in turn.
- (3) Press " AM/PM " to choose AM or PM. AM or PM will be selected in turn by press the button of " AM/PM " continuously.
- (4) Press " CLOCK/PRE-SET " to finish clock setting, and the clock indicator will go out. ":" will be flashing and the clock will be lighted.
- (5) If the numbers input are not within the range of 1:00--12:59, the setting will be invalid until valid numbers are input.





Note: In the process of clock setting, if the " STOP/CLEAR " button is pressed or if there is no operation within 1 minute, the oven will go back to the former setting automatically.

## 3. Kitchen Timer



- (1) Press " KITCHEN TIMER ", LED will display 00:00, clock indicator will be lighted. The first "0" will flash; ":" and the other "0" will be lighted.
- (2) Press the number keys and enter the correct time.(the maximum cooking time is 99 minutes and 99 seconds)
- (3) Press " START/+30SEC. " to confirm setting, clock indicator will be lighted.
- (4) When the kitchen time is reached, clock indicator will go out. The buzzer will ring 5 times.  
If the clock be set(12-hour system), LED will display the current time.

Note: The kitchen Time is differ from 12-hour system,Kitchen Timer is a timer.

## 4. Microwave cook

- (1) Keep on pressing " POWER " to choose microwave power. "  " and "  " or "  " will be lighted.
- (2) Press number keys to input the cooking time; the maximum cooking time is 99 minutes and 99 seconds.



(3) Press " START/+30SEC. " to start cooking, and the remained cooking time will be displayed. ":", "  ", "  " or "  " indicators will be flashing.

Note: In the process of cooking, if the " STOP/CLEAR " button is pressed or if there is no operation within 1 minute, the oven will go back to the former setting automatically.



## 5. Fast Starting

(1) In waiting state, instant cooking at 100% power level can be started by select a cooking time from 1 to 6 minutes by pressing number pads1 to 6. Press " STRAT/+30SEC " to increase the cooking time; the maximum cooking time is 99 minutes and 59 seconds.

(2) In waiting state, instant cooking at 100% power level with 30 seconds' cooking time can be started by pressing " STRAT/+30SEC ". Each press on the same button will increase cooking time by 30 seconds. the maximum cooking time is 99 minutes and 59 seconds.

Note: Each press on " STRAT/+30SEC" can increase the cooking by 30 seconds for the microwave and Auto menu cooking. However, the operation will not work under "Weight Defrost" operation.



## 6. Weight Defrost Function

(1) Press " WEIGHT DEFROST ", LED will display "DEF1"; when at the same time "  ", "  " indicators will be lighted.





(2) Press numerical pads to input weight to be defrosted. "Oz" indicator will be lighted. Input the weight ranged between 4~100 Oz.

(3) If the weight input is not within 4~100, the input will be invalid. No "beep" will be sound and the microwave will not work until valid numbers are input .

(4) Press " START/+30SEC. " to start defrosting and the remained cooking time will be displayed. ":", "  " and "  " indicators will be flashing and the "Oz" indicator will go out.

## 7. Time Defrost Function



(1) Press " TIME DEFROST ", LED will display "dEF2". At the same time, "  ", "  " indicators will be lighted.



(2) Press number pads to input defrosting time. The effective time range is 00:01~99:99





(3) If the time input is not within 00:01~99:99, no "beep" will be sound and the microwave will not work until valid numbers are input.

(4) The default microwave power is power level 3. If you want to change the power level, press " POWER " once, and the LED will display "PL 3", then press the number pad of the power level you wanted.





(5) Press " START/+30SEC. " to start defrosting. The remained cooking time will be displayed. ":", "  " and "  " indicators will be flashing.

## 8. POPCORN

### a) Default mode

- 1) Press "POPCORN" to select popcorn mode, ", "" and "Oz" are light. "1.75", "3.0", "3.5" appears in the display.
- 2) Press "STRAT/+30SEC." to start cooking, the buzzer will ring once, "Oz" will go out, ", "" will flash.
- 3) When the cooking is over, the buzzer will ring 5 times, LED will display "0:00". If the clock be setted(12-hour system), LED will display the currently time.

### b) Cooking-time adjustable mode



- 1) Press "POPCORN" to select popcorn mode, ", "" and "Oz" are light. "1.75", "3.0", "3.5" appears in the display.
- 2) Press "MEMORY", LED will display the cooking time of the weight, the minute figure is flashing.
- 3) Press the number keys and enter the time.
- 4) Press "MEMORY" to save the setting. If straight press "STRAT/+30 SEC.", the oven will to cook with the amended cooking time. ", "" will flash.

Users can change the cooking time

e.g.: Users set "POPCORN" time for 3 minutes and 15 seconds

- 1) Press "POPCORN" button once or twice when the oven is on call ( the screen will display "1.75" for once press and "3.0" for twice), then press "MEMORY" button, LED screen will display the default cooking time of current food weight ( which is not 0:00 ), for example 1'30". on the screen the first number 1 glints, press number button to input 3; the second number 3 glints, press number button to input 1; the third number 0 glints, press number button to input 5. and then the first number 3 glints again (It is similar as clock setting ).
- 2) Press "MEMORY" again to save current setting. If press "STRAT/+30SEC." to begin cooking directly, the program will save the latest setting of cooking time automatically.
- 3) To change the set cooking time, repeat step 1), the screen will firstly display the saving time ( 3:15 for example ), press number button to reset cooking time, and the follow step 2).
- 4) When completed, whenever press "POPCORN" button, screen displays food weight 1.75 , 3.0 or 3.5, only cooking time follows the saved time setting.
- 5) To go back to initialization, press "POPCORN" button for more than three seconds, the buzzer will sound, then go back to initial setting.

## 9. POTATO



a) Press "POTATO" repeatedly until the number you wish appears in the display, ", " light.

"1"SET: 1 potato (approximate 230 gram)

"2"SET: 2 potatoes (approximate 460 gram)

"3"SET: 3 potatoes (approximate 690 gram)

For example, press "POTATO" once : "1" displays.

b) Press "START/+30 SEC." to cook, ", " are flashing, time counts down.

Times( Press "Potato")	Weight	Display
Once	1set	
Twice	2set	
Thrice	3set	

## 10. PIZZA

a) Press " PIZZA " repeatedly until the number you wish appears in the display, " ", " " light.

You can reheat 1~3 slices of Pizza each time .

Times( Press "Pizza")	Weight	Display
Once	1(about 3.0 Oz)	
Twice	2(about 6.0 Oz)	
Thrice	3(about 9.0 Oz)	

For example, press" PIZZA " twice, "2" appears in the LED.

b) Press " START/+30 SEC." to cook, " ", " " are flashing, time counts down.

## 11.BEVERAGE

a) Press " BEVERAGE " repeatedly until the number you wish appears in the display, " ", " ", " light.

You can reheat 1~3 cups of beverage each time (approximate 250 ML).

For example, press "BEVERAGE" twice, "2"appears in the display.

b) Press " START/+30 SEC." to cook,

" ", " " are flashing, time counts down.

Times( Press "BEVERAGE")	Weight	Display
Once	1 M u g	
Twice	2Mugs	
Thrice	3Mugs	

## 12.SOUP

a) Press " SOUP " repeatedly until the number you wish appears in the display, " ", " ", "Oz" light.





For example, press "SOUP" twice, "8.0"appears in the display.



b) Press " START/+30 SEC." to cook,

" ", " " light, time counts down.





Times( Press "SOUP ")	Weight	Display
Once	4.0 Oz	
Twice	8.0 Oz	
Thrice	12.0 Oz	
4 times	16.0 Oz	



### 13. DINNER PLATE

- a) Press " DINNER PLATE " repeatedly until the number you wish appears in the display, " , "  " and "Oz" light.  
For example, press " DINNER PLATE " twice, "12.0" appears in the display.
- b) Press " START/+30 SEC. " to cook, " , "  " are flashing, time counts down.





Times( Press "DINNER PLATE")	Weight	Display
Once	9.0 Oz	
Twice	12.0 Oz	
Thrice	18.0 Oz	



### 14.FRESH VEGETABLE

- a) Press " FRESH VEGETABLE " repeatedly until the number you wish appears in the display, " , "  " and "Oz" light.  
For example, press " FRESH VEGETABLE " twice, "8.0" appears in the display.
- b) Press " START/+30 SEC. " to cook, "Oz" disappears, " , "  " are flashing, time counts down.

Times( Press "FRESH VEGETABLE")	Weight	Display
Once	4.0 Oz	
Twice	8.0 Oz	
Thrice	16.0 Oz	

### 15.FROZEN VEGETABLE

- a) Press " FROZEN VEGETABLE " repeatedly until the number you wish appears in the display, " , "  " and "Oz" light.  
For example, press " FROZEN VEGETABLE " twice, "8.0" appears in the display.
- b) Press " START/+30 SEC. " to cook, "Oz" disappears, " , "  " are flashing, time counts down.

Times( Press "FROZEN VEGETABLE")	Weight	Display
Once	4.0 Oz	
Twice	8.0 Oz	
Thrice	16.0 Oz	

## 16. PRE-SET FUNCTION

- (1) Set the clock first. (Consult the instruction of clock setting.)
- (2) Set a certain cooking procedure(one or two blocks), the setting method and display are same as relevant cooking procedure. (Defrosting is beyond pre-set cooking).
- (3) Press " CLOCK/PRE-SET " to display current time and hour figure is flashing, the icon " : " and other " 0 " keep lighting on.
- (4) Press number keys to input the cooking time.For example: to set the time is 12:12, you can press the number keys "1","2","1","2" in order.
- (5) Press " AM/PM " to choose AM or PM. AM or PM will be selected in turn by press the button of " AM/PM " continuously.
- (6) Press "START/ +30 SEC." to confirm the preset procedure.When it is confirmed, the unit will go back the clock states.
- (7) Cooking will began when time arrives.

## 17. MEMORY FUNCTION

- (1)Press "MEMORY" to choose memory 1-5 procedure. The LED will display 1,2,3...5.
- (2) If the procedure has been set, press " START/ +30 SEC." to use it. If not, continue to set the procedure. Only one or two stages can be set.
- (3) After finishing the setting, press "MEMORY" to save the procedure and turn back to the waiting states.If press " START/ +30 SEC." ,it can save and operate the setting.

Note: Auto menu cooking cannot be set as memory procedure.

## 18. MULTI-STAGE COOKING

This microwave oven can be set with 2 stages cooking.

Example: To defrost beef of 40 oz first and then cook with full power for 10 minutes.

- 1) Press "DEFROST BY W.T." to choose defrost by weight function;
- 2) Press "4","0" in sequence;
- 3) Press "POWER" once to choose full power;
- 4) Press "1","0","0","0" in sequence;
- 5) Press "Start/ +30 Sec." to start cooking.

Note: (1) Time defrost and auto function cooking can't be set as one of the 2 stages cooking.  
(2) Weight defrost can be set as the first stage cooking only.

## 19. LOCK FUNCTION FOR CHILDREN

Lock: In waiting state, press " STOP/CLEAR " for 3 seconds, there will be a long "beep"

denoting the entering the children-lock state; meanwhile, LED will display "  "

Lock quitting: In locked state, press " STOP/CLEAR " for 3 seconds, there will be a long "beep" denoting that lock is released.

## 20. INQUIRING FUNCTION

- (1) In clock state, press " AM/PM " to display "A" or "M" for 3 seconds.  
In cooking state, press " CLOCK/PRE-SET ", the LED will display clock for three seconds and the "A" or "M" for another 3 seconds.
- (2) In pre-set state, LED will display the clock and the seconds will be flashing at the same time. Press " AM/PM " and "A " or "M" will be displayed for 3 seconds. Then press " CLOCK/PRE-SET " to inquire the pre-set time. The pre-set time will be flashing for 3 seconds, then "A" or "M" will be displayed for another 3 seconds. After that, the oven will turn back to the clock state.
- (3) In the microwave cooking state, press " POWER " to inquire microwave power level, and the current microwave power will be displayed. After three seconds, the oven will turn back to the previous state. In the level 2 cooking state, the inquiring way can be done by the same way as above.

## 21. COOKING END REMINDING FUNCTION

When the cooking is over, the buzzer will sound 5 "beep" to alert user the cooking is finished.

## 22. OTHER SPECIFICATIONS

- (1) In standby state , if the set clock digital tube displays current time, the " : " would flash; otherwise, it shows " 0:00 ".
- (2) In setting function state, LED displays corresponding setting.
- (3) In working or pause state, LED displays remained cooking time.
- (4) During working, if it pauses or opens the oven door, "  " would light on, after restarting, it will flash constantly.
- (5) After setting a procedure, if there are no any operation in 5 minutes, it would exit setting status.
- (6) Refer to the sample for other details.

# Maintenance

## Troubleshooting

Check your problem by using the chart below and try the solutions for each problem. If the microwave oven still does not work properly, contact the nearest authorized service center.

TROUBLE	POSSIBLE CAUSE	POSSIBLE REMEDY
Oven will not start	<ul style="list-style-type: none"> <li>a. Electrical cord for oven is not plugged in.</li> <li>b. Door is open.</li> <li>c. Wrong operation is set.</li> </ul>	<ul style="list-style-type: none"> <li>a. Plug into the outlet.</li> <li>b. Close the door and try again.</li> <li>c. Check instructions.</li> </ul>
Arcing or sparking	<ul style="list-style-type: none"> <li>a. Materials to be avoided in microwave oven were used.</li> <li>b. The oven is operated when empty.</li> <li>c. Spilled food remains in the cavity.</li> </ul>	<ul style="list-style-type: none"> <li>a. Use microwave-safe cookware only.</li> <li>b. Do not operate with oven empty.</li> <li>c. Clean cavity with wet towel.</li> </ul>
Unevenly cooked foods	<ul style="list-style-type: none"> <li>a. Materials to be avoided in microwave oven were used.</li> <li>b. Food is not defrosted completely.</li> <li>c. Cooking time, power level is not suitable.</li> <li>d. Food is not turned or stirred.</li> </ul>	<ul style="list-style-type: none"> <li>a. Use microwave-safe cookware only.</li> <li>b. Completely defrost food.</li> <li>c. Use correct cooking time, power level.</li> <li>d. Turn or stir food.</li> </ul>
Overcooked foods	Cooking time, power level is not suitable.	Use correct cooking time, power level.
Undercooked foods	<ul style="list-style-type: none"> <li>a. Materials to be avoided in microwave oven were used.</li> <li>b. Food is not defrosted completely.</li> <li>c. Oven ventilation ports are restricted.</li> <li>d. Cooking time, power level is not suitable.</li> </ul>	<ul style="list-style-type: none"> <li>a. Use microwave-safe cookware only.</li> <li>b. Completely defrost food.</li> <li>c. Check to see that oven ventilation ports are not restricted.</li> <li>d. Use correct cooking time, power level.</li> </ul>
Improper defrosting	<ul style="list-style-type: none"> <li>a. Materials to be avoided in microwave oven were used.</li> <li>b. Cooking time, power level is not suitable.</li> <li>c. Food is not turned or stirred.</li> </ul>	<ul style="list-style-type: none"> <li>a. Use microwave-safe cookware only.</li> <li>b. Use correct cooking time, power level.</li> <li>c. Turn or stir food.</li> </ul>

## LIMITED WARRANTY

What is covered and for how long?

This warranty covers the original retail purchaser, all defects in workmanship or materials for a period of:

Carry-In Service

12 Months (labor)

24 Months (parts)

10 Years Magnetron Tube (part only)

What is covered.

1. The mechanical and electrical parts, which serve as a functional purpose of this appliance for a period of 24 months. This includes all parts except glass, finish, and trim.
2. If the magnetron tube fails due to poor workmanship or material, the part will be replaced.

What will be done and how to obtain service?

1. We will repair or replace, at our discretion any mechanical or electrical part which proves to be defective in normal usage during the warranty period so specified.
2. There will be no charge to the purchaser for labor on any covered items during the initial 12 month period, and no charge for parts on any covered items during the initial 24 month period. The magnetron tube is covered for a period of ten years.
3. To obtain service, bring the unit to your nearest authorized Service depot. For name of the nearest authorized service center please call: 1-877-337-3639.

THIS WARRANTY COVERS APPLIANCES WITHIN THE CONTINENTAL UNITED STATES, CANADA AND PUERTO RICO. IT DOES NOT COVER THE FOLLOWING:

Damages from improper installation.

Damages in shipping.

Damage from misuse, abuse, accident, alteration, lack of proper care and maintenance, incorrect current or voltage or acts of God.

Damage from other than normal household use.

Damage from service by other than an authorized dealer or service center.

Decorative trims, glass or light bulbs.

Transportation and shipping costs.

THIS LIMITED WARRANTY IS GIVEN IN LIEU OF ALL OTHER WARRANTIES, EXPRESSED OR, INCLUDING THE WARRANTIES OF MERCHANTABILITY AND FITNESS FOR A PARTICULAR PURPOSE.

The remedy provided in this warranty is exclusive and is granted in lieu of all other remedies.

This warranty does not cover incidental or consequential damages, so the above limitations may not apply to you. Some States do not allow limitations on how long an implied warranty lasts, so the above limitations may not apply to you.

This warranty gives you specific legal rights, and you may have other rights, which vary, from state to state.

Haier America  
New York, NY 10018

# **IMPORTANT**

**Do Not Return This Product To The Store**

**If you have a problem with this product, please contact the  
"Haier Customer Satisfaction Center" at 1-877-337-3639.**

**DATED PROOF OF PURCHASE REQUIRED FOR WARRANTY SERVICE**

# **Haier**

**Haier America  
New York, NY 10018**