



Bottom Freezer Refrigerators

Safety Instructions 2, 3

Operating Instructions

Features 4, 5
 Controls 6-9
 Dispenser* 10
 Autofill* 11
 Water Filter 12
 Fresh Food Storage Options 13, 14
 Climate Zone & Temperature
 Controlled Drawer 15, 16
 Freezer 17
 Automatic Ice maker 18
 Care and Cleaning 19
 Replacing the Lights 20

Installation Instructions

Preparing to Install the
 Refrigerator 21, 22
 Installing the Refrigerator 23-33
 Installing the Water Line 34-36

Troubleshooting Tips 38, 39

Normal Operating Conditions 37
 Truth or Myth 40, 41

Consumer Support

GE Brillion™ Get Connected
 Starter Kit 42
 Warranty for U.S. Customers 43
 RPWF Water Filter Cartridge Limited
 Warranty 44
 Performance Data Sheet 45
 State of California Water Treatment
 Device Certificate 46
 Consumer Support Back Cover

**Owner's Manual and
Installation Instructions**

GE and GE Profile™ models

*Models that start with PFE, GFE, DFE,
and GNE are Standard Depth Models (SD)*

*Models that start with PYE and PWE
are Counter Depth Models (CD)*

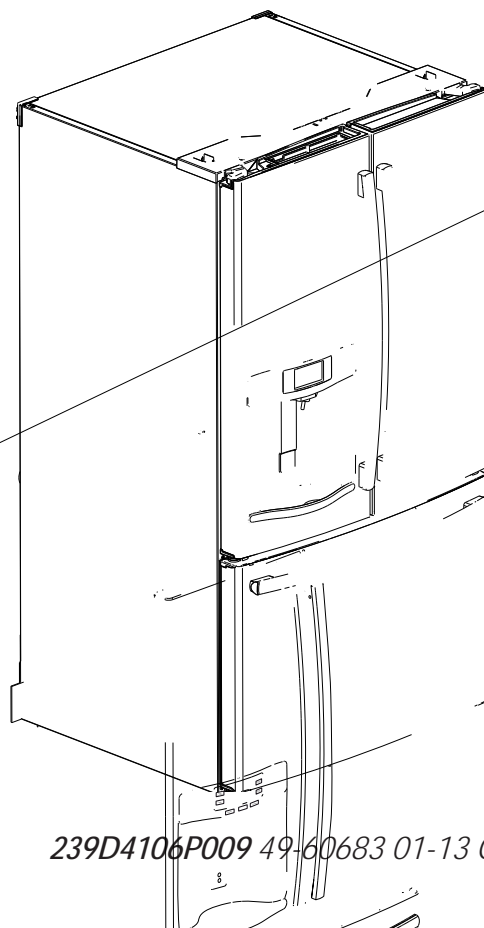

*Write the model and serial
numbers here:*

Model # _____

Serial # _____

Find these numbers on a label
on the left side, near the middle
of the refrigerator compartment.

*Select Models Only

IMPORTANT SAFETY INFORMATION. READ ALL INSTRUCTIONS BEFORE USING.

SAFETY

IMPORTANT SAFETY INFORMATION READ ALL INSTRUCTIONS BEFORE USING



GE Appliances website

For more information on your refrigerator's operation, visit
www.GEAppliances.com

REFRIGERATOR SAFETY INFORMATION

! This is the safety alert symbol. This symbol alerts you to potential hazards that can kill or hurt you and others. All safety messages will follow the safety alert symbol and the word "DANGER", "WARNING", or "CAUTION". These words are defined as:

! **DANGER** Indicates a hazardous situation which, if not avoided, **will** result in death or serious injury.

! **WARNING** Indicates a hazardous situation which, if not avoided, **could** result in death or serious injury.

! **CAUTION** Indicates a hazardous situation which, if not avoided, **could** result in minor or moderate injury.

IMPORTANT SAFETY INSTRUCTIONS

! **WARNING** To reduce the risk of fire, explosion, electric shock, or injury when using your refrigerator follow these basic safety precautions:

- This refrigerator must be properly installed and located in accordance with the Installation Instructions before it is used.
- Unplug the refrigerator before cleaning and making repairs.
- NOTE: Repairs must be performed by a qualified Service Professional.
- Replace all parts and panels before operating.
- Because of potential safety hazards under certain conditions, we strongly recommend against the use of an extension cord. However, if you must use an extension cord, it is absolutely necessary that it be a UL-listed (in the United States) or a CSA certified (in Canada), 3-wire grounding type appliance extension cord having a grounding type plug and outlet and that the electrical rating of the cord be 15 amperes (minimum) and 120 volts.
- To prevent suffocation and entrapment hazards to children, Remove the fresh food and freezer doors from any refrigerator before disposing of it or discontinuing its use.
- Do not store or use gasoline or other flammable vapors and liquids in the vicinity of this or any other appliance.
- Power to the refrigerator cannot be disconnected by any setting on the control panel, refrigerator must be unplugged to remove power.
- Do not allow children to climb, stand or hang on the door handles or the shelves in the refrigerator. They could seriously injure themselves.
- In refrigerators with automatic ice makers, avoid contact with the moving parts of the ejector mechanism, or with the heating element that releases the cubes. Do not place fingers or hands on the automatic ice making mechanism while the refrigerator is plugged in.
- Do not clean glass shelves or covers with warm water when they are cold. Glass shelves and covers may break if exposed to sudden temperature changes or impact, such as bumping or dropping. Tempered glass is designed to shatter into many small pieces if it breaks.
- Keep fingers out of the "pinch point" areas; clearances between the doors and between the doors and cabinet are necessarily small. Be careful closing doors when children are in the area.
- Do not touch the cold surfaces in the freezer compartment when hands are damp or wet, skin may stick to these extremely cold surfaces.
- Do not refreeze frozen foods which have thawed completely.
- Use a sturdy glass when dispensing ice (on models with ice dispenser)

INSTALLATION

! **WARNING**  **Explosion Hazard.**

Keep flammable materials and vapors, such as gasoline, away from refrigerator. Failure to do so can result in fire, explosion, or death.

SAFETY (CONT.)

⚠ WARNING



Tip Over Hazard.

Built-in style models (model PYE, CYE, and PWE) are top heavy, especially with any doors open. These models must be secured with the anti-tip floor bracket to prevent tipping forward, which could result in death or serious injury. Read and follow the entire installation instructions for installing the anti-tip floor bracket packed with your refrigerator.

CONNECTING ELECTRICITY

⚠ WARNING



Electrical Shock Hazard.

Plug into a grounded 3-prong outlet
 Do not remove the ground prong
 Do not use an adapter
 Failure to follow these instructions can result in death, fire, or electrical shock.



Do not, under any circumstances, cut or remove the third (ground) prong from the power cord. For personal safety, this appliance must be properly grounded.

The power cord of this appliance is equipped with a 3-prong (grounding) plug which mates with a standard 3-prong (grounding) wall outlet to minimize the possibility of electric shock hazard from this appliance.

Have the wall outlet and circuit checked by a qualified electrician to make sure the outlet is properly grounded.

Where a standard 2-prong wall outlet is encountered, it is your personal responsibility and obligation to have it replaced with a properly grounded 3-prong wall outlet. Do not use an adapter.

The refrigerator should always be plugged into its own individual electrical outlet which has a voltage rating that matches the rating plate.

A 115 Volt AC, 60 Hz, 15- or 20-amp fused, grounded electrical supply is required. This provides the best performance and also prevents overloading house wiring circuits which could cause a fire hazard from overheated wires.

Never unplug your refrigerator by pulling on the power cord. Always grip plug firmly and pull straight out from the outlet.

Repair or replace immediately all power cords that have become frayed or otherwise damaged. Do not use a cord that shows cracks or abrasion damage along its length or at either end.

When moving the refrigerator away from the wall, be careful not to roll over or damage the power cord.

PROPER DISPOSAL OF YOUR OLD REFRIGERATOR

⚠ WARNING

Suffocation and child entrapment hazard.

Remove fresh-food and freezer doors from the refrigerator, prior to disposal. Failure to do so can result in child entrapment which can lead to death or brain damage.

IMPORTANT:

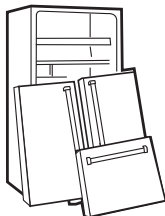

Child entrapment and suffocation are not problems of the past. Junked or abandoned refrigerators are still dangerous even if they will sit for "just a few days." If you are getting rid of your old refrigerator, please follow the instructions below to help prevent accidents.

Before You Throw Away Your Old Refrigerator or Freezer:

- Take off the fresh food and freezer doors.
- Leave the shelves in place so that children may not easily climb inside.

Refrigerants

All refrigeration products contain refrigerants, which under federal law must be removed prior to product disposal. If you are getting rid of an old refrigeration product, check with the company handling the disposal about what to do.



**READ AND FOLLOW THIS SAFETY INFORMATION CAREFULLY.
 SAVE THESE INSTRUCTIONS**

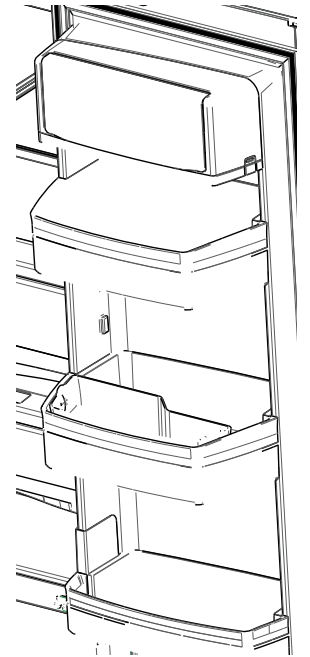

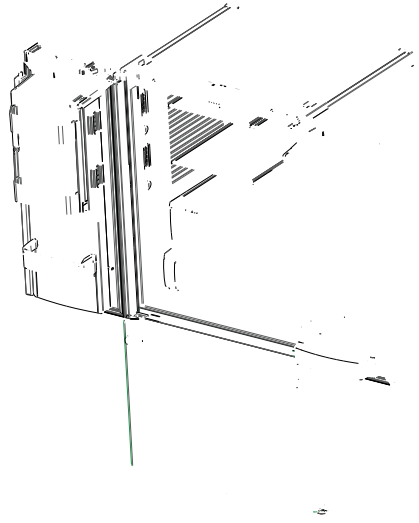

About the controls with temperature settings.

PFE29, PYE23P Control Style A, LCD External Control

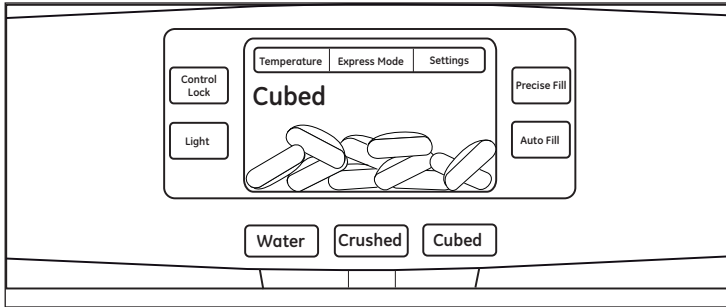

PFE27, PYE23K Control Style B, LCD External Control

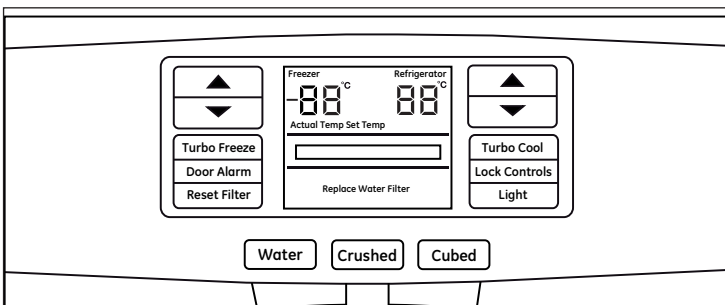

GFE29, GFE27, DFE29 Control Style C, External Control

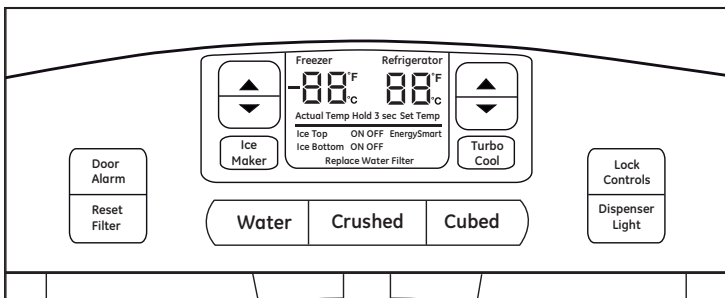

GNE26, PWE23 Control Style D, Internal Control

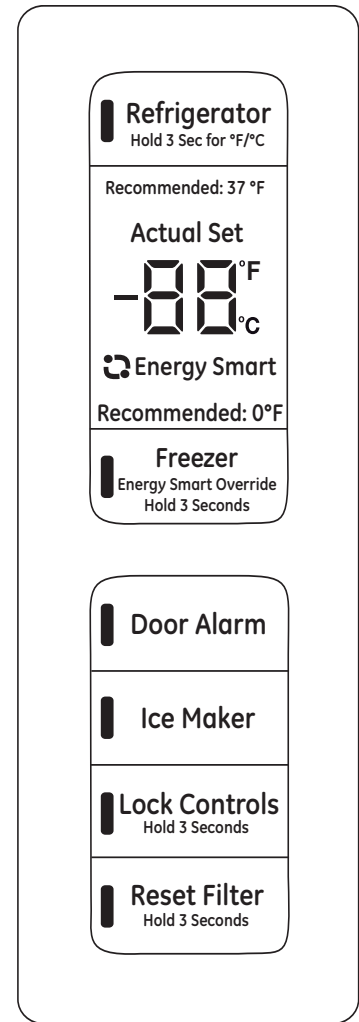

NOTE: The refrigerator is shipped with protective film covering the temperature controls. If this film was not removed during installation, remove it now.

The temperature controls are preset in the factory at 37°F for the refrigerator compartment and 0°F for the freezer compartment. Allow 24 hours for the temperature to stabilize to the preset recommended settings.

The temperature controls can display both the SET temperature as well as the actual temperature in the refrigerator and freezer. The actual temperature may vary slightly from the SET temperature based on usage and operating environment.

Changing the Temperature for Control Style A

To Change the Refrigerator Temperature:

Access By: Temperature Button 

Activate By: Below the word "Refrigerator", use the arrows to select the desired temperature. Press **DONE** when finished to return to **HOME** screen.

To Change the Freezer Temperature:

Access By: Temperature Button 

Activate By: Below the word "Freezer", use the arrows to select the desired temperature.



Press **DONE** when finished to return to **HOME** screen.

To turn **OFF** cooling system, access **SETTINGS** from the **HOME** screen. Page over and tap **COOLING SYSTEM ON**. Press **DONE** to return to **HOME** screen.

To turn **ON** cooling system, access **SETTINGS** from the **HOME** screen. Page over and tap **COOLING SYSTEM OFF**. Press **DONE** to return to **HOME** screen.

Turning the cooling system off stops the cooling to refrigerator, but it does not shut off the electrical power.



Changing the Temperature for Control Style B

To change the temperature, press and release the  pad. The **ACTUAL TEMP** light will come on and the display will show the actual temperature. To change the temperature, tap either the  pad until the desired temperature is displayed.

To turn **OFF** cooling system, press and hold the Freezer  pads simultaneously for 3 seconds. When the cooling system is **OFF** the display should read **OFF**.

To turn **ON** cooling system, press either  pad. The display will show **ON** and then the actual temperature for the refrigerator and the freezer. Turning the cooling system **OFF** stops the cooling to the refrigerator, but it does not shut **OFF** the electrical power.

Changing the Temperature for Control Style C

To change the temperature, press and release the  pad. The **ACTUAL TEMP** light will come on and the display will show the actual temperature. To change the temperature, tap either the  pad until the desired temperature is displayed.

To turn **OFF** cooling system, press and hold the Freezer  pads simultaneously for 3 seconds. When the cooling system is **OFF** the display should read **OFF**.

To turn **ON** cooling system, press either  pad. The display will show the preset temperature settings of **37°F** for refrigerator and **0°F** for freezer. Turning the cooling system off stops the cooling to refrigerator, but it does not shut off the electrical power.

Changing Temp. for Control Style D

Temperature Display is located on inside of left-hand refrigerator door. To change the temperature, press and release the **REFRIGERATOR** or **FREEZER** pad. The **ACTUAL TEMP** light will come on and the display will show the actual temperature. To change the temperature, tap either the **REFRIGERATOR** or **FREEZER** pad until the desired temperature is displayed.

To turn **OFF** cooling system, press and hold the **REFRIGERATOR** and **FREEZER** pads simultaneously for 3 seconds. When the cooling system is **OFF** the display should read **OFF**.

To turn **ON** cooling system, press either **REFRIGERATOR** or **FREEZER** pad. The display will show the preset temperature settings of **37°F** for refrigerator and **0°F** for freezer. Turning the cooling system off stops the cooling to refrigerator, but it does not shut off the electrical power.

NOTE: For optimal temperature performance, we recommend to avoid placing food items directly at the air flow vents of the fresh food air tower and thus blocking the air flow.

About the controls - features.

Control Style A, External Controls PFE29, PYE23P

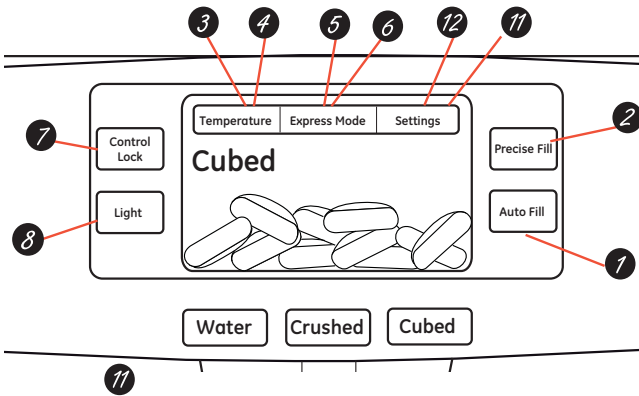

- 1 Hands-free Autofill***
Hands-free Autofill uses sensors to monitor container height to automatically dispense filtered water without having to activate the paddle.
- 2 PreciseFill setting***
Precisely dispenses filtered water in accurate measurements in ounces, cups, quarts, or liters using paddle.
- 3 Refrigerator temp control**
Adjust freezer compartment temperature.
- 4 Fresh food temp control**
Adjust fresh food compartment temperature.
- 5 TurboFreeze™ setting**
Activate TurboFreeze to quickly restore freezer temperatures after frequent door openings.
- 6 TurboCool™ setting**
Activate TurboCool to quickly restore fresh food temperature after frequent door openings.
- 7 Lock controls**
Press and hold 3 seconds to lock out ice and water dispenser and all feature and temperature buttons.
- 8 LED dispenser light**
LED lighting that can be turned on/off to light your dispenser.

Control Style B, External Controls PFE27, PYE23K

PFE27, PYE23K

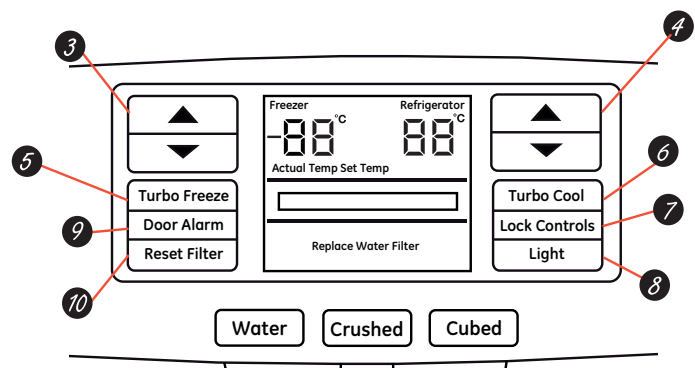

- 9 Door Alarm**
Sounds to alert when the freezer or fresh food doors have been left open.
- 10 Reset filter**
Press and hold for 3 seconds after replacing the filter.
- 11 Photo upload***
Insert USB memory stick to upload personal photos to the refrigerator LCD screen. LCD will provide on screen prompts to load and view slideshow.

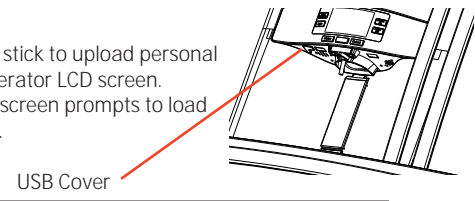

- 12 Additional settings:**
 - Photo upload and delete
 - Slideshow
 - Connected Home ready
 - Reset water filter
 - Ice maker on/off
 - Door alarm
 - Sound control
 - Cooling system On/Off
 - Metric/English units
 - Auto fill video tutorial

Additional Modes

- **Sabbath Mode**
Press and hold lock & light simultaneously for 3 seconds to enter/exit Sabbath mode. Activate Sabbath Mode to turn off interior lights, temperature control and advanced features. Compressor will run on a timed defrost when in Sabbath mode.

*Select Models Only

About the controls - features.*

Control Style C, External Controls

GFE29, GFE27,
DFE29

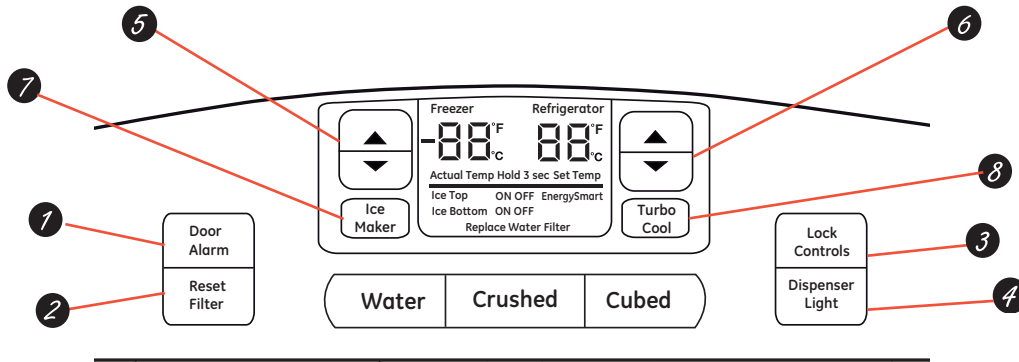

Controls Style D, Internal Controls GNE26, PWE23

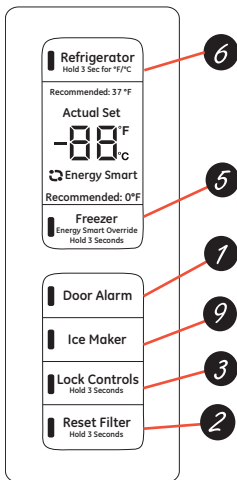

- 1 Door Alarm**
Sounds to alert when the freezer or fresh food doors have been left open.
- 2 Reset Filter**
Hold for 3 seconds after replacing filter.
- 3 Lock Controls**
Press and hold 3 seconds to lock out ice and water dispenser and all feature and temperature buttons.
- 4 LED dispenser light**
LED lighting that can be turned on/off to light your dispenser.

- 5 Freezer temp control**
Adjust freezer compartment temperature
- 6 Refrigerator temp control**
Adjust fresh food compartment temperature
- 7 Dual ice maker control***
Turn your ice makers on/off.
- 8 TurboCool™ setting**
Activate TurboCool to quickly restore refrigerator temperature after frequent door openings.
- 9 Ice maker setting**
Turn your ice makers on/off.

*Select Models Only

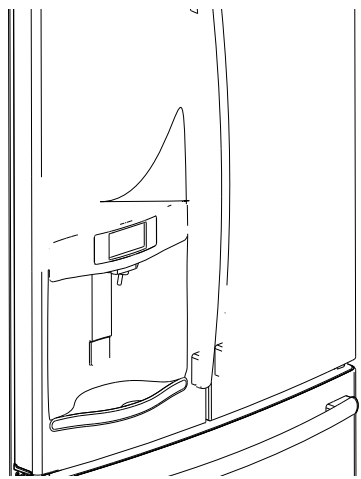

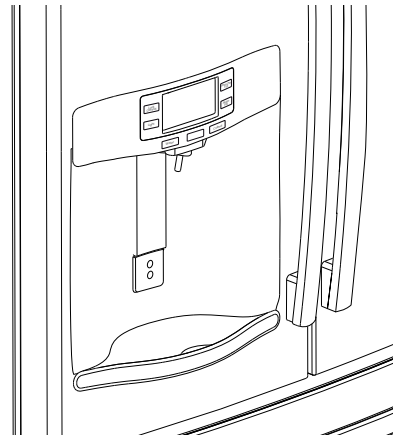
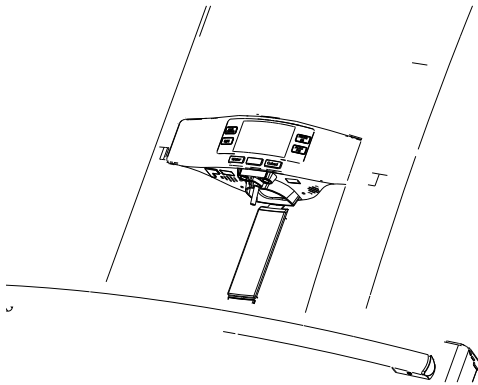

About the GE® RPWF water filter cartridge.

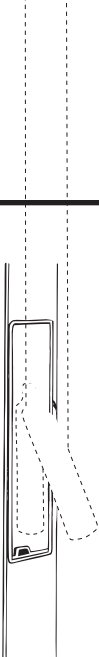

About the fresh food storage options.

Rearranging the Shelves

Shelves in the refrigerator compartment are adjustable.

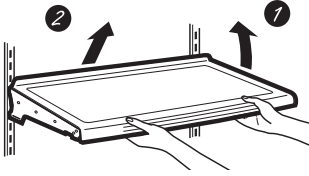

To remove:

- 1 Remove all items from the shelf.
- 2 Tilt the shelf up at the front.
- 3 Lift the shelf up at the back and bring the shelf out.

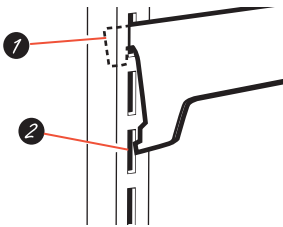

To replace:

- 1 While tilting the shelf up, insert the top hook at the back of the shelf in a slot on the track.
- 2 Lower the front of the shelf until the bottom of the shelf locks into place.

Spillproof Shelves

Spillproof shelves have special edges to help prevent spills from dripping to lower shelves.

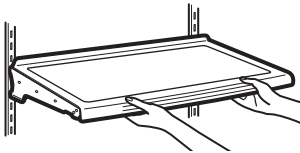

Quick Space Shelf

This shelf splits in half and slides under itself for storage of tall items on the shelf below.

This shelf can be removed and replaced or relocated (just like spillproof shelves).

NOTE: The location of the upper Quick Space Shelf is not adjustable.

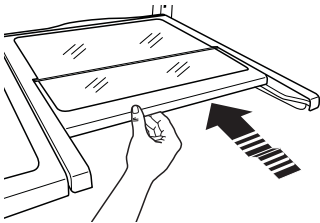

About the fresh food storage options.

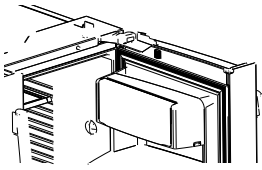

Non-Adjustable Dairy Bin

To remove: Lift the dairy bin straight up, then pull out.

To replace: Engage the bin in the molded door supports and push down. The bin will lock in place. See page 33.

Adjustable Bins on the Door

Adjustable bins can easily be carried from refrigerator to work area.

To remove: Lift bin straight up, then pull out.

To replace or relocate: Slide in the bin just above the molded door supports, and push down. The bin will lock in place. See page 33.

Drop down tray * (tray open)

1. Open right fresh food door
2. Depress both buttons on lower sides of bin and bin will drop down.
3. Reverse to reinstall.

Non-Adjustable Bins on the Door

To remove: Lift the bin straight up, then pull out.

To replace: Engage the bin in the molded supports on the door and push down. It will lock in place.

The ice maker door bins are not interchangeable, note the location upon removal and replace the bin in its proper location.

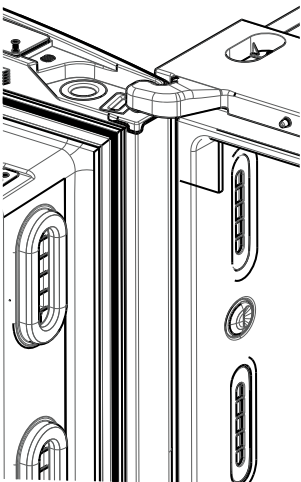

About the climate zone and temperature controlled drawer.

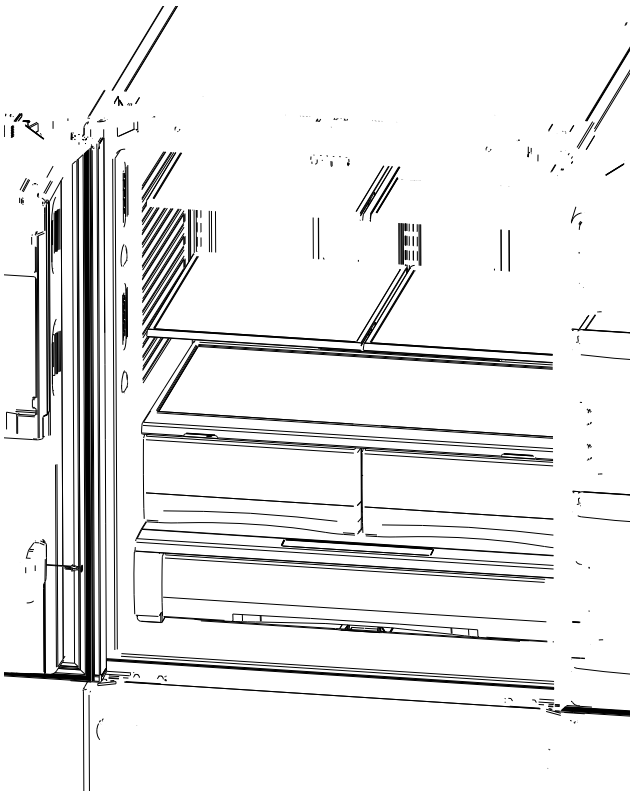

ClimateZone

Keep fruits and vegetables organized in separate compartments for easy access.

Excess water that may accumulate in the bottom of the drawers or under the drawers should be wiped dry.

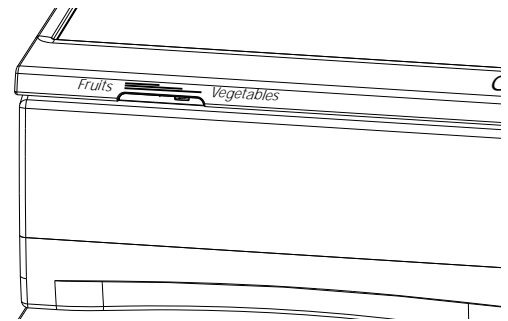

Temperature Controlled Drawer*

The Temperature Controlled Drawer is a full-width drawer with adjustable temperature control. This drawer can be used for large miscellaneous items.

To change setting, press select button.

⚠ CAUTION

Laceration Hazard

Do not store glass bottles at this setting. If they are frozen, they can break and cause personal injury.

About the climate zone and temperature controlled drawer.

How to Remove and Replace the Adjustable Deli/Produce Drawer

To remove:

- 1 Pull the drawer out to the stop position.
- 2 Lift the front of the drawer up and out.

To replace:

- 1 Pull left and right slides until fully extended.
- 2 Place drawer back in first and rotate drawer front down to seat on slide.
- 3 Push the drawer in to closed position.

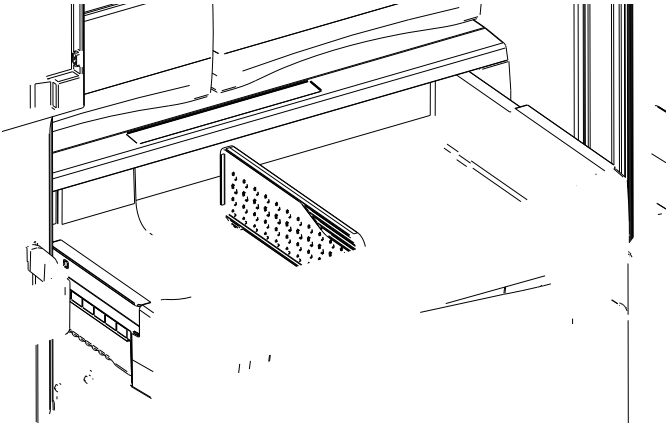

How to Remove and Replace Drawer Divider

To remove:

- 1 Pull the drawer out to the stop position.
- 2 Raise the front side of the divider to unhook it from the rear wall of the drawer.

To replace:

- 1 Hook the back of the divider over the rear wall of the drawer.
- 2 Push the divider down.

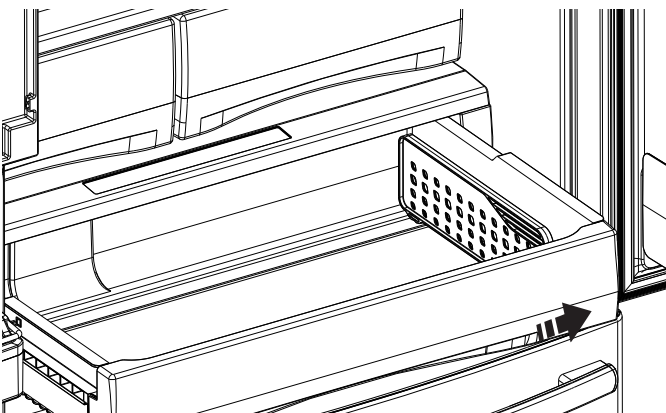

About the automatic ice maker.

A newly installed refrigerator may take 12 to 24 hours to begin making ice.

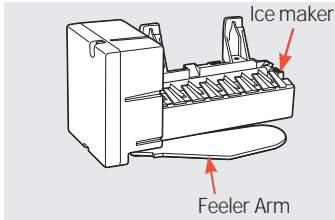

Automatic Ice Maker*

The ice maker will produce seven cubes per cycle approximately 100–130 cubes in a 24-hour period, depending on freezer compartment temperature, room temperature, number of door openings and other use conditions.

The ice maker will fill with water when it cools to 15°F (-10°C). A newly installed refrigerator may take 12 to 24 hours to begin making ice cubes.

If the refrigerator is operated before the water line connection is made to the unit or if the water supply to an operating refrigerator is turned off, make sure that the ice maker is turned off. Once the water has been connected to the refrigerator, the ice maker may be turned on. See the table below for details.

You may hear a buzzing sound each time the ice maker fills with water.

Throw away the first few batches of ice to allow the water line to clear.

Be sure nothing interferes with the sweep of the feeler arm.

When the bin fills to the level of the feeler arm, the ice maker will stop producing ice. It is normal for several cubes to be joined together.

If ice is not used frequently, old ice cubes will become cloudy, taste stale and shrink.

NOTE: In homes with lower-than-average water pressure, you may hear the ice maker cycle multiple times when making one batch of ice.

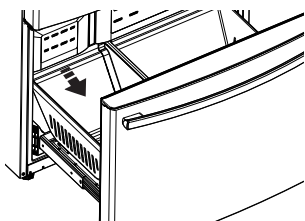
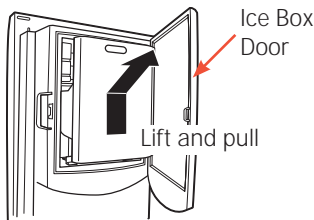

Cleaning the Outside

The stainless steel panels, door handles and trim.

Do not use appliance wax, polish, bleach, or other products containing chlorine on stainless steel.

Stainless steel (on some models) can be cleaned with a commercially available stainless steel cleaner. A spray-on stainless steel cleaner works best.

Silver-accented plastic parts.

Wash parts with soap or other mild detergents. Wipe clean with a sponge, damp cloth or paper towel.

Do not use scouring pads, powdered cleaners, bleach or cleaners containing bleach because these products can scratch and weaken the paint finish.

Should spill tray need cleaning use lime remover.

Cleaning the Inside

To help prevent odors, leave an open box of baking soda in the refrigerator and freezer compartments.

Unplug the refrigerator before cleaning.

If this is not practical, wring excess moisture out of sponge or cloth when cleaning around switches, lights or controls.

Use an appliance wax polish on the inside surface between the doors.

Use warm water and baking soda solution—about a tablespoon (15 ml) of baking soda to a quart (1 liter) of water.

This both cleans and neutralizes odors.

Rinse and wipe dry.

CAUTION

Do not clean glass shelves or covers with warm water when they are cold. Glass shelves and covers may break if exposed to sudden temperature changes or impact such as bumping or dropping. Tempered glass is designed to shatter into many small pieces if it breaks.

Behind the Refrigerator

Be careful when moving the refrigerator away from the wall. All types of floor coverings can be damaged, particularly cushioned coverings and those with embossed surfaces.

Raise the leveling legs located at the bottom front of the refrigerator.

Pull the refrigerator straight out and return it to position by pushing it straight in. Moving the refrigerator in a side direction may result in damage to the floor covering or refrigerator.

Lower the leveling legs until they touch the floor.

When pushing the refrigerator back, make sure you don't roll over the power cord or water supply line.

Preparing for Vacation

For long vacations or absences, remove food and unplug the refrigerator. Clean the interior with a baking soda solution of one tablespoon (15 ml) of baking soda to one quart (1 liter) of water. Leave the doors open.

LCD Models: turn refrigerator off at control (pg 7) .

If the temperature can drop below freezing, have a qualified service technician drain the water supply system to prevent serious property damage due to flooding.

1) Turn refrigerator off (pg. 7) or unplug the refrigerator.

2) Empty ice bucket

3) Turn water supply off

If you cut the water supply off, turn off the ice maker (pg. 18).

Upon returning from vacation:

1) Replace the water filter.

2) Run 2 gallons of water through the cold water dispenser (about 5 minutes) to flush the system.

Preparing to Move

Secure all loose items such as shelves and drawers by taping them securely in place to prevent damage.

When using a hand truck to move the refrigerator, do not rest the front or back of the refrigerator against the hand truck. This could damage the refrigerator.

Handle only from the sides of the refrigerator.

Be sure the refrigerator stays in an upright position during moving.

Replacing the lights.

Refrigerator Lights (LEDs)

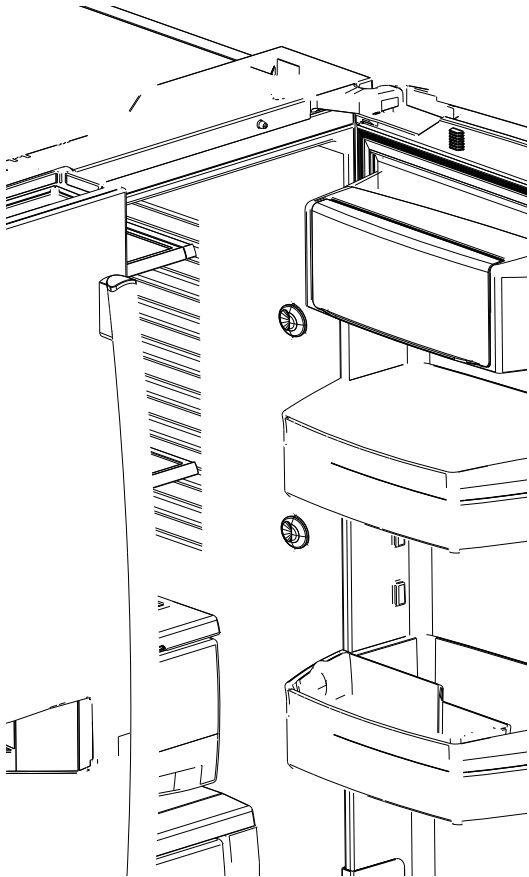

There is LED lighting in fresh food compartment and on the bottom of the fresh food doors to light the freezer compartment.*

An authorized technician will need to replace the LED light.

If this assembly needs to be replaced, call GE Service at 1.800.432.2737 in the United States or 1.800.561.3344 in Canada.

Installation Instructions

Refrigerator

GE and GE Profile™ models

Questions? Call 800.GE.CARES (800.432.2737) or visit our Website at: GEAppliances.com
In Canada, call 1.800.561.3344 or visit our Website at: www.GEAppliances.ca

BEFORE YOU BEGIN

Read these instructions completely and carefully.

WARNING **Tip Over Hazard.**

Built-in style models (model PYE, CYE, and PWE) are top heavy, especially with any doors open. These models must be secured with the anti-tip floor bracket to prevent tipping forward, which could result in death or serious injury. Read and follow the entire installation instructions for installing the anti-tip floor bracket packed with your refrigerator.

- **IMPORTANT** – Observe all governing codes and ordinances. Save these instructions for local inspector's use.
- Note to Installer – Be sure to leave these instructions with the Consumer.
- Note to Consumer – Keep these instructions for future reference.
- Skill level – Installation of this appliance requires basic mechanical skills.
- Completion time – Refrigerator Installation can vary
Water Line Installation 30 minutes
- Proper installation is the responsibility of the installer.
- Product failure due to improper installation is not covered under the Warranty.

PREPARATION

MOVING THE REFRIGERATOR INDOORS

If the refrigerator will not fit through a doorway, the refrigerator door and freezer drawer can be removed.

- To remove the refrigerator door, see the Installing the Refrigerator section.
- To remove the freezer drawer, see the Removing the Freezer Drawer section.

WATER SUPPLY TO THE ICE MAKER AND DISPENSER

If the refrigerator has an ice maker, it will have to be connected to a cold water line. A GE water supply kit (containing tubing, shutoff valve, fittings and instructions) is available at extra cost from your dealer, by visiting our website at GEAppliances.com (in Canada at www.GEAppliances.ca) or from Parts and Accessories, 800.626.2002 (in Canada 1.800.661.1616).

TOOLS YOU MAY NEED

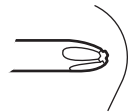

Installation Instructions

DIMENSIONS All measurements are given with leveling leg fully retracted.

Counter Depth (CD) Models Only

Standard Depth (SD) Models Only

	SD	CD
Overall Height to Top of Hinge Cover	69 ⁷ / ₈ "	69 ⁷ / ₈ "
Height to Top of Cabinet	69"	69"
Case Depth without Doors	29 ³ / ₈ "	24 ³ / ₈ "
Overall Exterior Case Width	35 ³ / ₄ "	35 ³ / ₄ "
Overall Exterior Depth Doors/Drawers with Handles	36 ¹ / ₄ "	31 ¹ / ₄ "

Moving THE REFRIGERATOR

- Using the chart below determine if the width of your passageway can accommodate the depth of the refrigerator. Ensure you have clearance to prevent damage to the refrigerator before safety moving it to the final location.
- If passageways are large enough to accommodate the refrigerator without removing the handles skip to Step 6. Leave tape, film and all packaging on doors until the refrigerator is in the final location.
- NOTE: Use a padded hand truck or moving straps to move this refrigerator. Place the refrigerator on the hand truck with a side against the truck. We strongly recommend that two people move and complete this installation.

If your model number starts with PFE (SD)

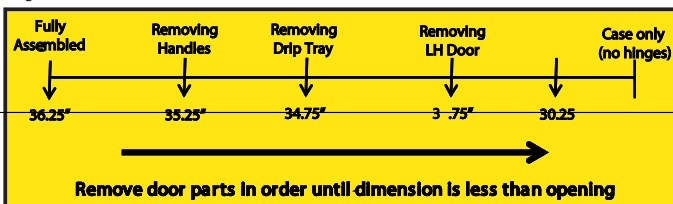

If your model number starts with CFE (SD)

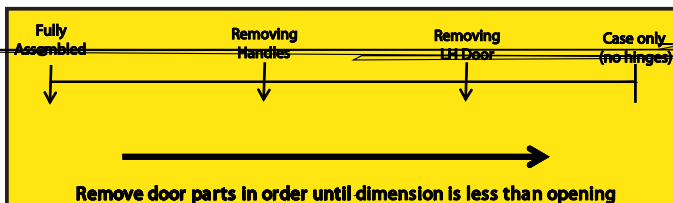

Installation Instructions

INSTALLING THE REFRIGERATOR

REFRIGERATOR LOCATION

- Do not install the refrigerator where the temperature will go below 60°F (16°C) because it will not run often enough to maintain proper temperatures.
- Do not install the refrigerator where the temperature will go above 100°F (37°C) because it will not perform properly.
- Install it on a floor strong enough to support it fully loaded.

CLEARANCES

Allow the following clearances for ease of installation, proper air circulation and plumbing and electrical connections.

Sides	1/8" (3 mm)
Top	1" (25 mm) Cabinet/Hinge Cover
Back	2" (50 mm)

1 REMOVE THE FRESH FOOD DOOR HANDLE

Handle Design varies based on models, however Installation is same.

Stainless steel and plastic handles:

- Ⓐ Loosen the set screws with the 1/8" Allen wrench and remove the handle.

NOTE: If the handle mounting fasteners need to be tightened or removed, use a 1/4" Allen wrench.

2 REMOVE THE FREEZER DOOR HANDLE

Handle Design varies based on models, however Installation is same.

Stainless steel and plastic handles:

- Ⓐ Loosen the set screws with the 1/8" Allen wrench and remove the handle.

NOTE: If the handle mounting fasteners need to be tightened or removed, use a 1/4" Allen wrench.

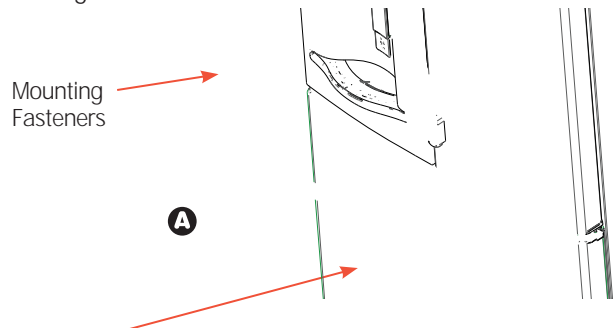

Installation Instructions

INSTALLING THE REFRIGERATOR (cont.)

3 REMOVE THE REFRIGERATOR DOORS

- A** Securely tape the door shut with masking tape or have a second person support the door.

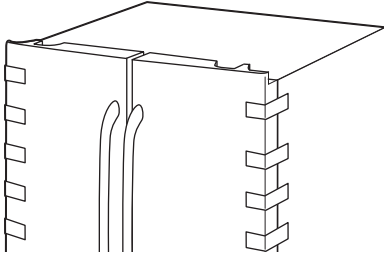

- B** Start with left-hand door first: Remove the hinge cover on top of the left refrigerator door by removing all hex screws and pulling it up. Do the same for the right-hand door and the middle cover.

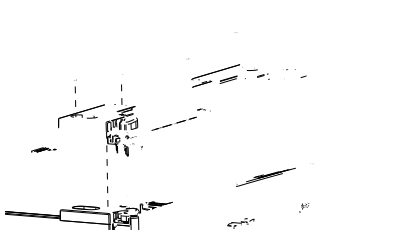

- C** Disconnect both electrical connectors at the top cover.

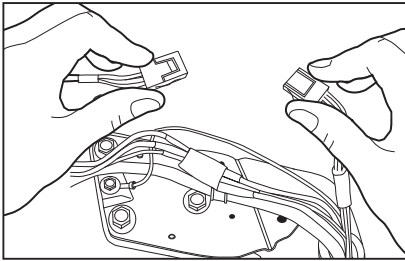

Remove the 1/4" hex head screw to disconnect the ground wire from the hinge.
Remove the 1/4" hex head screw to remove the strain relief from the water line.

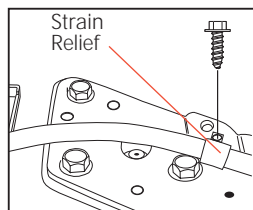
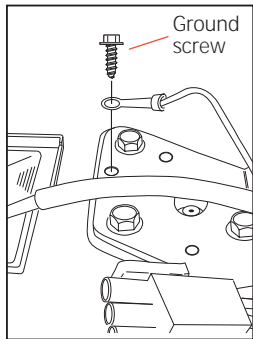

REMOVE THE REFRIGERATOR DOORS (cont)

- D** Disconnect the water line from the back of the unit by pressing down on the dark grey collar while pulling up on the water line.
Pull water line through case conduit from the top to free the line for door removal. The water line is more than 4' long and may need to be taped to Door for accessibility when reinstalling.

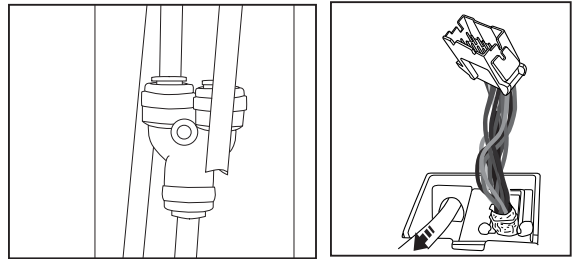

- E** Using a 3/8" socket ratchet/driver, remove the screws securing the top hinge to the cabinet, then lift the hinge straight up to free the hinge pin from the location in the top of the door.

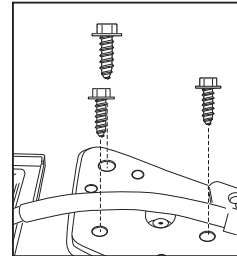

CAUTION Lifting Hazard.

Single person lift could cause injury. Use assistance when handling, moving or lifting the refrigerator doors.

Note: when removing door, to prevent damage to door and electronics, carefully place the door in a proper location.

Note: The lower door hinge pin and hinge are keyed and must be matched correctly for the door to self close properly. Please follow the directions carefully.

Installation Instructions

INSTALLING THE REFRIGERATOR (cont.)

REMOVE THE REFRIGERATOR DOORS (cont)

Note: for proper installation later, please follow the next step carefully.

- F Remove the tape and keeping the door as straight as possible, open the door to 90° then lift straight up to remove it.

4 REMOVE OPPOSITE DOOR

Follow the same procedure on the opposite door. There are no wires or water lines on the opposite side

REMOVE CENTER HINGE (if necessary)

Remove the 3/8" screws securing the center hinge to the cabinet.

Use T20 driver to remove outboard screw

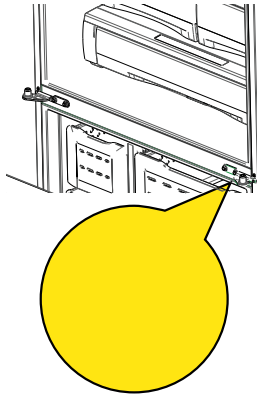

5 REINSTALLING THE REFRIGERATOR DOORS

Reverse steps 1 through 4 to reinstall refrigerator, follow details below for critical alignments.

- A Reinstall center hinge first and torque the screws to 65 in-lbs. With the LH door at 90° to the front of the case, lower the refrigerator door onto the center hinge. Ensure that the door and hinge align correctly.

- B Rotate doors closed and make sure moveable center sealing portion of the door aligns with the striker. *If the door will not self-close after reinstalling, remove door, turn door upside down, check alignment mark and arrow; (there is an alignment mark on the door closure mechanism It corresponds to an alignment arrow on the plastic ring. Rotate door closure mechanism to align mark and arrow, reinstall door).*

Securely tape the door shut with masking tape or have a second person support the door. Reinstall the top hinge and torque the screws to 65 in-lbs.

- C Be sure to reinstall the ground wire and strain relief to the top hinge.
- D Reinstall hinge cover. **NOTE:** Ensure wires are not pinched or under screw bosses before tightening screws.

Installation Instructions

INSTALLING THE REFRIGERATOR (cont.)

6 REMOVE THE FREEZER DOOR

- A Pull the freezer door open to full extension.
- B Remove 3 attachment screws, located at the bottom on each side of the freezer door using 3/8" hex socket driver.

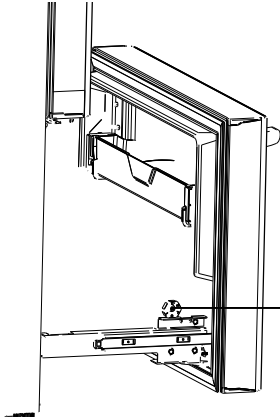

CAUTION Lifting Hazard

Freezer door is heavy Use both hands to secure the door before lifting.

- C Lift the freezer door to disengage it from the slide mechanism

The door can safely rest on the bottom. Do not rest the door on any other surfaces to avoid scratches.

Push the slide mechanism back completely until it self retracts.

7 REPLACING THE FREEZER DOOR

- A Pull the slide Mechanism to full extension using both hands simultaneously.
- B Remove the basket resting on the slides.

CAUTION Lifting Hazard

Freezer door is heavy Use both hands to secure the door before lifting.

- C Lift the freezer door and place it on the slide mechanism

- D Replace the attachment screws and torque the screws to 65 in-lb

For adjusting freezer door gaps, follow the instructions on pg 27.

Replace the basket

Installation Instructions

INSTALLING THE REFRIGERATOR (cont.)

Instructions for adjusting freezer door gaps:

IMPORTANT!

The 6 mounting screws (3 on each side) are NOT interchangeable with the center or top hinge screws. Drawer screws have flat washer heads, and other screws have lines/ribs on washer heads.

After installation of the freezer door, check for uniform gaps (top and bottom of right and left hand side) with the template provided.

In the event of excessive gaps use the following steps to adjust the freezer door.

Step 1 - Loosen the 3 screws on each side (right and left) of the freezer door.

Step 2 - Adjust set screw clockwise if gap at the top is too big (see template). Turn the set screw using 3/32" hex key clockwise by quarter to half a rotation

Step 3 - Adjust set screw counter-clockwise if gap at the bottom is too big (see template). Turn the set screw using 3/32" hex key counter-clockwise by quarter to half a rotation

Step 4 - Tighten the 3 screws on each side (right and left).

Step 5 - Re-check the gaps using the template and repeat steps 1 to 4 if required and complete with step 5.

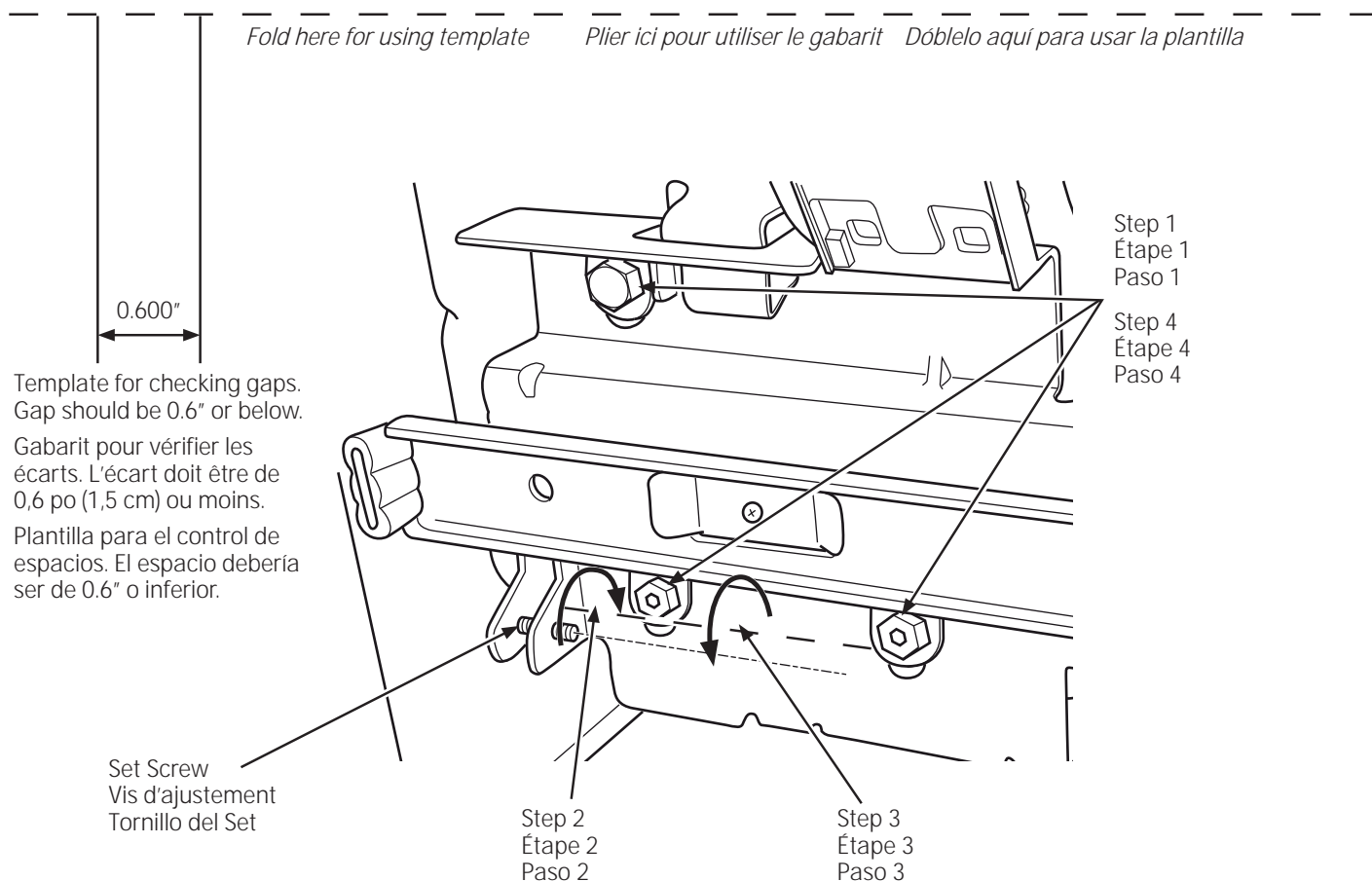

Refer to 239D4144P001, Pub No. 31-45474-2

Installation Instructions

Anti-Tip Floor Bracket

PYE, PWE Models Only

WARNING



Tip Over Hazard.



Built-in style models (model PYE, CYE, and PWE) are top heavy, especially with any doors open. These models must be secured with the anti-tip floor bracket to prevent tipping forward, which could result in death or serious injury. Read and follow the entire installation instructions for installing the anti-tip floor bracket packed with your refrigerator.

NOTE:

If you did not receive an anti-tip bracket with your purchase, call 1.800.626.8774 to receive one at no cost. (In Canada, call 1.800.561.3344.) For installation instructions of the bracket, visit: www.GEAppliances.com. (In Canada, www.GEAppliances.ca.)

MATERIALS YOU MAY NEED (not included)

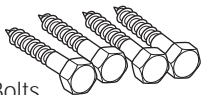

Lag Bolts
1/4" (6 mm) x 1-1/2" (38 mm)



Anchor Sleeves
1/2" (12 mm) OD

Drill Bit Appropriate for Anchors

For Anti-Tip Bracket Mounted on CONCRETE Floors Only

AT-1 MEASURE CABINET OPENING AVAILABLE VS. REFRIGERATOR WIDTH

Measure width of cabinet opening where refrigerator will be placed, W.

Be sure to account for any countertop overhang, baseboard thickness and any clearance desired. Width, W, should not be less than 36". The refrigerator will be placed approximately in the middle of this opening.

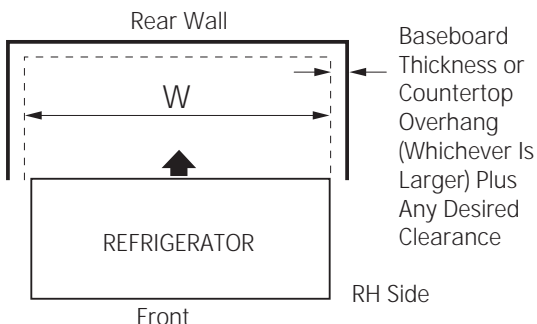

TOOLS YOU WILL NEED

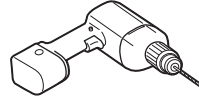

1/8" (3 mm) Drill Bit and
Electric or Hand Drill

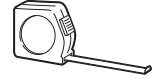

Tape measure



Pencil



5/16" (8 mm) Nut Driver

AT-2 LOCATING THE ANTI-TIP FLOOR BRACKET

- A** Place the anti-tip floor bracket locator template (included inside the anti-tip kit) onto the floor up against the rear wall, within W, and in line with the desired location of the RH side of the refrigerator (see Figure 1).

Figure 1 – Installation Overview

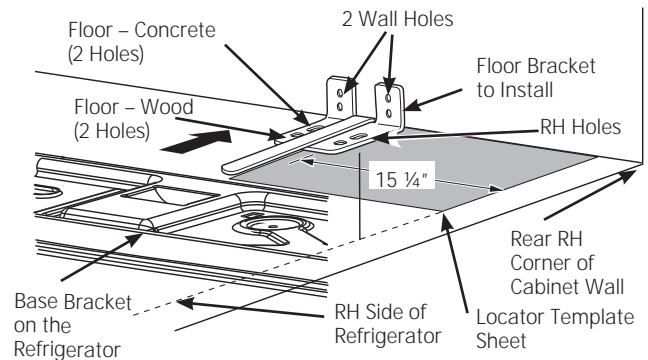

- B** Place the anti-tip floor bracket onto the locator template with its RH floor holes lined up with the floor holes indicated on the template sheet, approximately 15 1/4" from the edge of the sheet or the RH side of the refrigerator.
- C** Hold down in position and use the anti-tip floor bracket as a template for marking the holes based upon your configuration and type of construction as shown in Step 3. Mark the hole locations with a pencil, nail or awl.

NOTE:

- It is REQUIRED to use at least 2 screws to mount the floor bracket (one on each side of the anti-tip floor bracket). Both must be into either the wall or the floor. Figure 2 indicates all the acceptable mounting configurations for screws. Identify the screw holes on the anti-tip floor bracket for your configuration.

Refer to 239D1142P001, Pub No. 31-45484-2

Installation Instructions

AT-2 LOCATING THE ANTI-TIP FLOOR BRACKET (cont.)

Figure 2 – Acceptable Screw Placement Locations

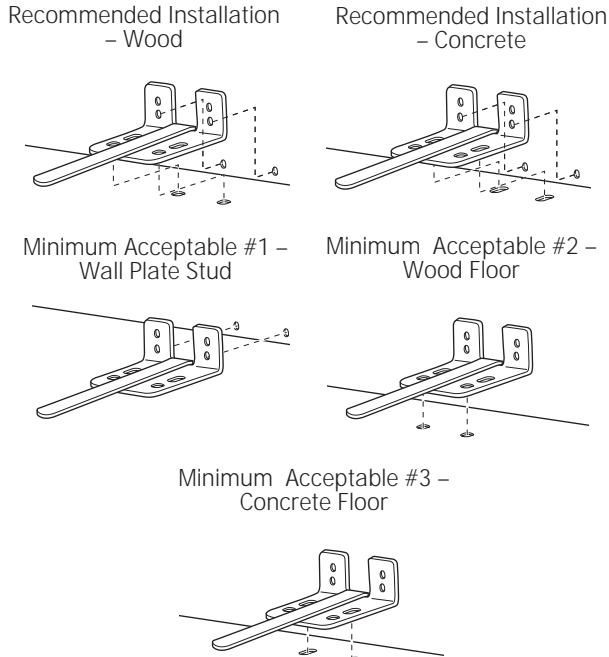

B CONCRETE Wall and Floor Construction:

- Anchors required (not provided):
4 each 1/4" (6 mm) x 1-1/2" (38 mm) lag bolts
4 each 1/2" (12 mm) O.D. sleeve anchors
- Drill the recommended size holes for the anchors into the concrete at the center of the holes marked in Step 2.
- Install the sleeve anchors into the drilled holes. Place the anti-tip floor bracket as indicated in Step 2. Remove the locator template from the floor.
- Install the lag bolts through the anti-tip floor bracket and tighten appropriately.

C WOOD Wall and TILE Floor Construction:

- For this special case, locate the 2 wall holes identified in Fig. 1. Drill an angled 1/8" (3 mm) pilot hole (approx. as shown in Fig. 3) in the center of each hole.
- Mount the anti-tip floor bracket using the Minimum Acceptable Installation #1, as illustrated in Fig. 2.

AT-3 ANTI-TIP BRACKET INSTALLATION

A WOOD Wall and Floor Construction:

- Drill the appropriate number of 1/8" (3 mm) pilot holes in the center of each floor bracket hole being used (a nail or awl may be used if a drill is not available) AND remove the locator template from the floor.
- Mount the anti-tip floor bracket by fastening the 2, or recommended 4, #10-16 hex-head screws tightly into place as illustrated in Figure 3.

Figure 3 – Attachment to Wall and Floor

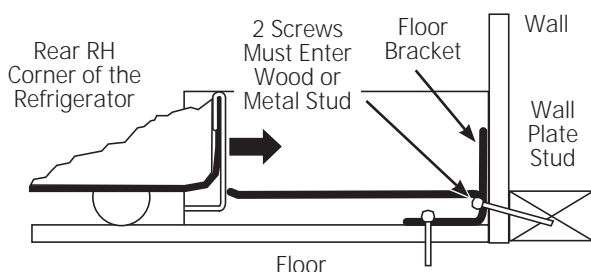

AT-4 POSITIONING THE REFRIGERATOR TO ENGAGE THE ANTI-TIP FLOOR AND BASE BRACKETS

- A** Before pushing the refrigerator into the opening, plug the power cord into the receptacle and connect waterline (if equipped). Check for leaks.
- B** Locate the refrigerator's RH side and move back approximately in line with the RH side of the cabinet opening, W. This should position the anti-tip floor bracket to engage the anti-tip base bracket on the refrigerator.
- C** Gently roll the refrigerator back into the cabinet opening until it comes to a complete stop. Check to see if the refrigerator front lines up with the cabinet front face. If not, carefully rock the refrigerator forward and backward until engagement occurs and you notice that the refrigerator is fully pushed up against the rear wall.
- D** **If Applicable:** Adjust the rear (and front) wheel height settings to fully engage the rear anti-tip brackets, while also aligning the refrigerator front with the cabinet front face.

NOTE:

If you pull the refrigerator out and away from the wall for any reason, make sure the anti-tip floor bracket is engaged when the refrigerator is pushed back against the rear wall.

Installation Instructions

INSTALLING THE REFRIGERATOR (cont.)

11 CONNECTING THE REFRIGERATOR TO THE HOUSE WATER LINE

A cold water supply is required for automatic ice maker operation. If there is not a cold water supply, you will need to provide one. See Installing the Water Line section.

NOTES:

- Before making the connection to the refrigerator, be sure the refrigerator power cord is not plugged into the wall outlet.
- If your refrigerator does not have a water filter, we recommend installing one if your water supply has sand or particles that could clog the screen of the refrigerator's water valve. Install it in the water line near the refrigerator. If using GE SmartConnect™ Refrigerator Tubing Kit, you will need an additional tube (WX08X10002) to connect the filter. Do not cut plastic tube to install filter.
- Before connecting the water line to the house, purge the house line for at least 2 minutes.

A If you are using copper tubing, place a compression nut and ferrule (sleeve) onto the end of the tubing coming from the house cold water supply.

If you are using the GE SmartConnect™ tubing, the nuts are already assembled to the tubing.

B If you are using copper tubing, insert the end of the tubing into the refrigerator connection, at the back of the refrigerator, as far as possible. While holding the tubing, tighten the fitting.

If you are using GE SmartConnect™ tubing, insert the molded end of the tubing into the refrigerator connection, at the back of the refrigerator, and tighten the compression nut until it is hand tight. Then tighten one additional turn with a wrench. Over tightening may cause leaks.

C Fasten the tubing into the clamp provided to hold it in position. You may need to pry open the clamp.

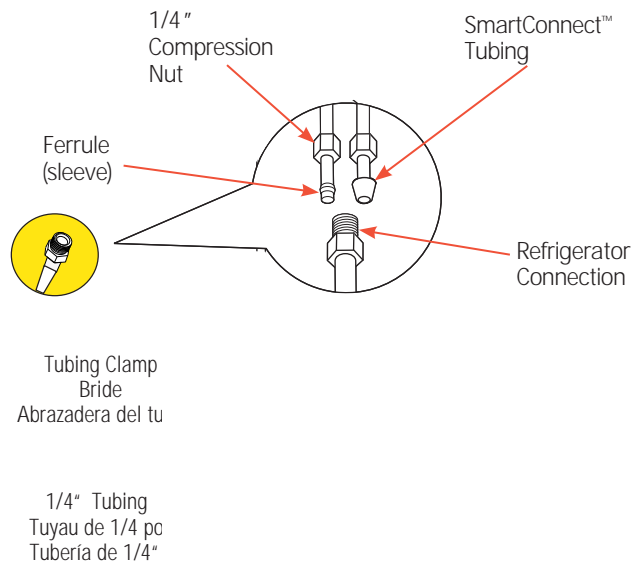
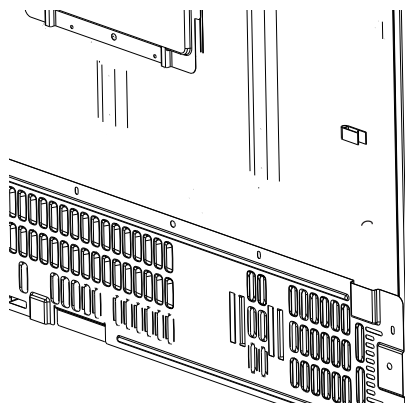

Installation Instructions

12 TURN ON THE WATER SUPPLY

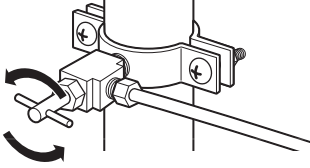

Turn the water on at the shutoff valve (house water supply) and check for any leaks.

PLUG IN THE REFRIGERATOR

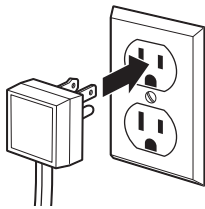

See the grounding information attached to the power cord.

14 LEVEL THE REFRIGERATOR

The leveling legs have 2 purposes:

- 1) Leveling legs adjust so the refrigerator is firmly positioned on the floor and does not wobble.
- 2) Leveling legs serve as a stabilizing brake to hold the refrigerator securely in position during operation and cleaning. The leveling legs also prevent the refrigerator from tipping.

- A** Turn the leveling legs clockwise to raise the refrigerator, counterclockwise to lower it.



NOTICE: To avoid possible property damage, the leveling legs must be firmly touching the floor.

Installation Instructions

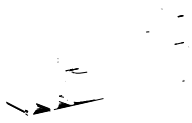
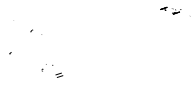

Installation Instructions

INSTALLING THE WATER LINE

BEFORE YOU BEGIN

Recommended copper water supply kits are WX8X2, WX8X3 or WX8X4, depending on the amount of tubing you need. Approved plastic water supply lines are GE SmartConnect™ Refrigerator Tubing (WX08X10006, WX08X10015 and WX08X10025).

When connecting your refrigerator to a GE Reverse Osmosis Water System, the only approved installation is with a GE RVKit. For other reverse osmosis water systems, follow the manufacturer's recommendations.

If the water supply to the refrigerator is from a Reverse Osmosis (RO) Water Filtration System AND the refrigerator also has a water filter, use the refrigerator's filter bypass plug. Using the refrigerator's water filtration cartridge in conjunction with the RO water filter can result in hollow ice cubes.

This water line installation is not warranted by the refrigerator or ice maker manufacturer. Follow these instructions carefully to minimize the risk of expensive water damage.

Water hammer (water banging in the pipes) in house plumbing can cause damage to refrigerator parts and lead to water leakage or flooding. Call a qualified plumber to correct water hammer before installing the water supply line to the refrigerator.

To prevent burns and product damage, do not hook up the water line to the hot water line.

For PFE27 and PYE23K Models: If the refrigerator is operated before the water connection is made to the ice maker, press and hold both the CRUSHED and CUBED buttons together for 3 seconds to disengage the ice maker. When the refrigerator has been connected to the water supply, press and hold both the CRUSHED and CUBED buttons together for 3 seconds to re-engage the ice maker.

For Non-LCD Models: If the refrigerator is operated before the water connection is made to the ice maker, press and release the ICE MAKER button on the control panel to disengage the ice maker. When the refrigerator has been connected to the water supply, press and release the ICE MAKER button on the control panel to re-engage the ice maker.

For PFE29 and PYE23P Models: If the refrigerator is operated before the water connection is made to the ice maker, see ICE MAKER under SETTINGS menu of the LCD Operations section and follow the screen commands to turn the ice maker OFF.

Do not install the ice maker tubing in areas where temperatures fall below freezing.

When using any electrical device (such as a power drill) during installation, be sure the device is double insulated or grounded in a manner to prevent the hazard of electric shock, or is battery powered.

All installations must be in accordance with local plumbing code requirements.

WHAT YOU WILL NEED

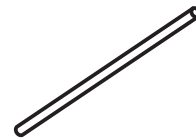

- Copper or GE SmartConnect™ Refrigerator Tubing kit, 1/4" outer diameter to connect the refrigerator to the water supply. If using copper, be sure both ends of the tubing are cut square.

To determine how much tubing you need: measure the distance from the water valve on the back of the refrigerator to the water supply pipe. Be sure there is sufficient extra tubing to allow the refrigerator to move out from the wall after installation.

GE SmartConnect™ Refrigerator Tubing Kits are available in the following lengths:

- | | |
|-------------|--------------|
| 6' (1.8 m) | – WX08X10006 |
| 15' (4.6 m) | – WX08X10015 |
| 25' (7.6 m) | – WX08X10025 |

Installation Instructions

INSTALLING THE WATER LINE (cont.)

WHAT YOU WILL NEED (CONT.)

NOTE: The only GE approved plastic tubing is that supplied in GE SmartConnect™ Refrigerator Tubing kits. Do not use any other plastic water supply line because the line is under pressure at all times. Certain types of plastic will crack or rupture with age and cause water damage to your home.

- A GE water supply kit (containing tubing, shutoff valve and fittings listed below) is available at extra cost from your dealer or from Parts and Accessories, 800.626.2002 (in Canada 1.800.661.1616).
- A cold water supply. The water pressure must be between 20 and 120 p.s.i. (1.4–8.1 bar).

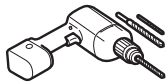

- Power drill.
- 1/2" or adjustable wrench.
- Straight and Phillips blade screwdriver.

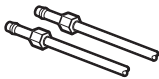

- Two 1/4" outer diameter compression nuts and 2 ferrules (sleeves)—to connect the copper tubing to the shutoff valve and the refrigerator water valve.

OR

- If you are using a GE SmartConnect™ Refrigerator Tubing kit, the necessary fittings are preassembled to the tubing.

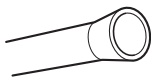

- If your existing copper water line has a flared fitting at the end, you will need an adapter (available at plumbing supply stores) to connect the water line to the refrigerator OR you can cut off the flared fitting with a tube cutter and then use a compression fitting. Do not cut formed end from GE SmartConnect™ Refrigerator tubing.

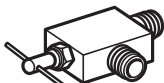

- Shutoff valve to connect to the cold water line. The shutoff valve should have a water inlet with a minimum inside diameter of 5/32" at the point of connection to the COLD WATER LINE. Saddle-type shutoff valves are included in many water supply kits. Before purchasing, make sure a saddle-type valve complies with your local plumbing codes.

Install the shutoff valve on the nearest frequently used drinking water line.

1 SHUT OFF THE MAIN WATER SUPPLY

Turn on the nearest faucet long enough to clear the line of water.

2 CHOOSE THE VALVE LOCATION

Choose a location for the valve that is easily accessible. It is best to connect into the side of a vertical water pipe. When it is necessary to connect into a horizontal water pipe, make the connection to the top or side, rather than at the bottom, to avoid drawing off any sediment from the water pipe.

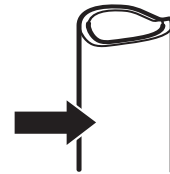

3 DRILL THE HOLE FOR THE VALVE

Drill a 1/4" hole in the water pipe (even if using a self-piercing valve), using a sharp bit. Remove any burrs resulting from drilling the hole in the pipe.

Take care not to allow water to drain into the drill.

Failure to drill a 1/4" hole may result in reduced ice production or smaller cubes.

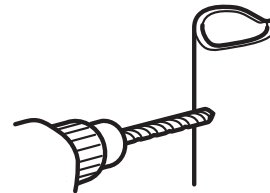

Installation Instructions

INSTALLING THE WATER LINE (cont.)

4 FASTEN THE SHUTOFF VALVE

Fasten the shutoff valve to the cold water pipe with the pipe clamp.

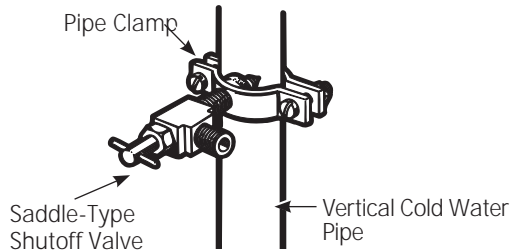

NOTE: Commonwealth of Massachusetts Plumbing Codes 248CMR shall be adhered to. Saddle valves are illegal and use is not permitted in Massachusetts. Consult with your licensed plumber.

5 TIGHTEN THE PIPE CLAMP

Tighten the clamp screws until the sealing washer begins to swell.

NOTE: Do not over tighten or you may crush the tubing.

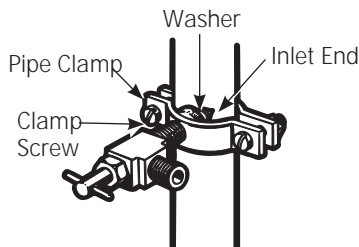

6 ROUTE THE TUBING

Route the tubing between the cold water line and the refrigerator.

Route the tubing through a hole drilled in the wall or floor (behind the refrigerator or adjacent base cabinet) as close to the wall as possible.

7 CONNECT THE TUBING TO THE VALVE

Place the compression nut and ferrule (sleeve) for copper tubing onto the end of the tubing and connect it to the shutoff valve.

Make sure the tubing is fully inserted into the valve. Tighten the compression nut securely.

For plastic tubing from a GE SmartConnect™ Refrigerator Tubing kit, insert the molded end of the tubing into the shutoff valve and tighten compression nut until it is hand tight, then tighten one additional turn with a wrench. Over tightening may cause leaks.

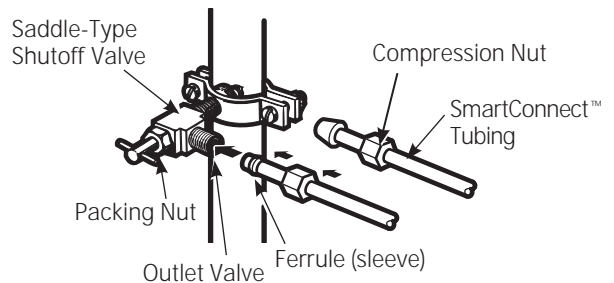

NOTE: Commonwealth of Massachusetts Plumbing Codes 248CMR shall be adhered to. Saddle valves are illegal and use is not permitted in Massachusetts. Consult with your licensed plumber.

8 FLUSH OUT THE TUBING

Turn the main water supply on and flush out the tubing until the water is clear.

Shut the water off at the water valve after about one quart (1 liter or 2 minutes) of water has been flushed through the tubing.



To complete the installation of the refrigerator, go back to Step 11 in Installing the Refrigerator.



Newer refrigerators sound different from older refrigerators.
Modern refrigerators have more features and use newer technology.

Do you hear what I hear? These sounds are normal.

HUMMM... WHOOSH...

- The new high efficiency compressor may run faster and longer than your old refrigerator and you may hear a high-pitched hum or pulsating sound while it is operating.
- You may hear a whooshing sound when the doors close. This is due to pressure equalizing within the refrigerator.
- After dispensing ice, a motor will close the ice chute to keep warm room air from entering the ice bucket, maintaining ice at a freezing temperature.

The hum of the motor closing the ice chute is normal, shortly after dispensing ice.



- You may hear the fans spinning at high speeds. This happens when the refrigerator is first plugged in, when the doors are opened frequently or when a large amount of food is added to the refrigerator or freezer compartments. The fans are helping to maintain the correct temperatures.
- The fans change speeds in order to provide optimal cooling and energy savings.

CLICKS, POPS, CRACKS and SNAPS

- You may hear cracking or popping sounds when the refrigerator is first plugged in. This happens as the refrigerator cools to the correct temperature.
- Expansion and contraction of cooling coils during and after defrost can cause a cracking or popping sound.
- On models with an ice maker, after an ice making cycle, you may hear the ice cubes dropping into the ice bucket.
- On models with a dispenser, during water dispense, you may hear the water lines move at initial dispense and after dispenser button is released.

WATER SOUNDS



- The flow of refrigerant through the cooling coils may make a gurgling noise like boiling water.
- Water dropping on the defrost heater can cause a sizzling, popping or buzzing sound during the defrost cycle.
- A water dripping noise may occur during the defrost cycle as ice melts from the evaporator and flows into the drain pan.
- Closing the door may cause a gurgling sound due to pressure equalization.

START UP COOLING

It can take up to 24 hours for the refrigerator and freezer temperatures to match the display. During that time refrigerator and freezer door openings should be minimized.

TIPS

- Freezer cools first.
- Refrigerator compartment cools last; it may take several hours after the freezer.
- Turning off ice maker makes both fresh food and freezer food cool faster.

Before you call for service...



Troubleshooting Tips
Save time and money! Review the charts on the following pages first and you may not need to call for service.

Problem	Possible Causes	What to Do
Water filter indicator light remains lit after replacing filter	Water filter indicator must be reset	Non-LCD models: -Press and hold reset button. LCD models: -On the LCD screen select SETTINGS, then WATER FILTER. Select RESET.
Water filter indicator light is not lit	This is normal. This indicator will turn on to tell you that you need to replace the filter soon.	See <i>About the Water Filter</i> for more information.
Handle is loose/handle has a gap.	Handle needs adjusting	See <i>Attach Fresh Food Handle</i> and <i>Attach the Freezer Handle</i> sections for detailed instructions.
Refrigerator beeping	This is door alarm	-Turn off or disable with door closed -If door open and alarm is sounding, you can only snooze the alarm
Not cooling	The cooling system is off	See <i>About Controls</i> .
Water has poor taste/odor*	Water dispenser has not been used for a long time	Dispense water, until all water in system is replenished.
Water in glass is warm*	Normal when refrigerator is first installed	Wait 24 hours for the refrigerator to completely cool down.
	Water dispenser has not been used for a long time	Dispense water, until all water in system is replenished
	Water system has drained	Allow several hours for replenished supply to chill
Water dispenser does not work*	Water supply line turned off or not connected	See <i>Installing the Water Line</i>
	Water filter clogged or filter/bypass plug not installed	Replace filter cartridge or remove filter and install bypass plug
	Air may be trapped in the water system	Press the dispenser arm for at least 5 minutes.
	Water in reservoir is frozen because the controls are set too cold	Set the refrigerator control to a warmer setting and wait 24 hours. If the water does not dispense after 24 hours, call for service
Water spurting from dispenser*	Newly installed filter cartridge	Run water from the dispenser for 5 minutes (about 2 gallons)

*Select Models Only



Troubleshooting Tips (cont)

SERVICE

Before you call for service, review the detailed troubleshooting tips in the Owner's manual. If needed, service can be scheduled by visiting us online GEAppliances.com or calling 800.ge.CARES 800.432.2737

Truth or Myth

Truth or Myth?	Answer	Explanation
The refrigerator water filter may require replacement, even though the filter indicator has not turned red, or reads "Filter Expired."	TRUE	The water filter indicator will indicate the need to replace the water filter every six months. Water quality varies from city to city; if water flow from the dispenser slows, or ice production decreases, the water filter should be replaced, even though the filter indicator may not indicate the need for replacement.
The automatic ice maker in my refrigerator will produce ice when the refrigerator is plugged in to a power receptacle.	MYTH	The refrigerator must be connected to water, and the ice maker must be turned on. Make sure the ice maker is turned on, only after the water line is connected and water is turned on. The ice maker can be turned <i>on/off</i> from the controls and ensure the ice maker is on, as indicated on the refrigerator control panel. See <i>About the Automatic Ice Maker</i> .
After the refrigerator has been plugged in and connected to water, I will immediately have unlimited chilled water available from the water dispenser.	MYTH	The water dispenser tank located inside the refrigerator stores water for dispensing. The water in this tank requires 24 hours to chill after installation. High usage conditions will not allow time for the water to chill.
After water dispenses, a few drops of water are normal.	TRUE	A few drops of water may fall from the dispenser, after the dispenser paddle has been released. To minimize the drops, remove the glass slowly from the dispenser.
I will never see frost inside the freezer compartment.	MYTH	Frost inside the freezer typically indicates that the door is not properly sealed, or has been left open. If frost is found, clear the frost using a plastic spatula and towel, then check to ensure that no food packages or containers are preventing the freezer door from closing. Check the refrigerator control panel to ensure the door alarm is on.
When the refrigerator is installed, or after replacing the water filter, I must dispense water for five minutes.	TRUE	A newly installed refrigerator or water filter contains air in the water lines. Press the dispenser paddle and dispense cold water for at least 5 minutes to remove air from the water line, and flush the filter.
To fill the ice bucket to the maximum capacity, I should dispense 12 and 18 hours after installation.	TRUE	Dispensing 3-4 cubes 12 hours and 18 hours after installation, allows ice to disperse within the ice bucket, which in turns calls on the ice maker to produce additional ice. Normal ice production = 100 cubes in 24 hours.
I can use the water filter bypass plug to determine if the filter requires replacement.	TRUE	Decrease in flow from the water dispenser, or decreased ice production, may indicate the need to replace the water filter. Install the water filter bypass plug (provided with the refrigerator), and check flow from the dispenser. If water flow returns to normal with the bypass plug in place, replace the water filter.
The top of the refrigerator doors will always be aligned.	MYTH	Several things can affect the fresh food door alignment, including the floor the refrigerator is installed on, and loading of doors. If the top of the fresh food doors are not aligned, use a 1/4" allen wrench to adjust the right hand door. The adjustment screw is located on the bottom right hand side of the door; open the freezer door to access the screw. The left hand fresh food door may be raised using spacers. Call 800-GEARES to obtain the spacers.
Refrigerator door handles can be easily tightened.	TRUE	If door handles are loose or have a gap, the handle can be adjusted using a 1/8" allen wrench, on set screws located on the ends of the handles.
There may be odor and taste problems with your ice.	TRUE	After starting the ice maker throw away 24 hours of ice production to avoid odor and taste problems.
I can make fine adjustments to the fresh food doors to align them.	TRUE	If the fresh food doors are not aligned, use a 1/4" Allen wrench to adjust the right hand door. The adjustment screw is located on the bottom of the right door. Open the freezer door to access. The left hand fresh food door may be raised using spacers. Call 800-GEARES to obtain the spacers.
Door handles should always be removed for installation.	MYTH	Check chart on reverse side of this instruction. If the doors must be removed do not remove the handles, or if the refrigerator will fit easily through the passage way opening. Adjust handles that are loose or have a gap, by adjusting 1/8" set screws on either end of handles.

SERVICE

Before you call for service, review the detailed troubleshooting tips in the Owner's manual. If needed, service can be scheduled by visiting us online *GEAppliances.com* or calling 800.ge.CARES 800.432.2737

Truth or Myth (cont.)

Truth or Myth?	Answer	Explanation
Door removal is always required for installation.	MYTH	Check chart on reverse side of this instruction. Doors should only be removed when necessary to prevent damage from passage way or access to final location.
Refrigerator doors that won't close after installation, can be adjusted to close properly.	TRUE	Door mechanism works best if installed at 90°. If installed at 180°, remove the door from the mid hinge, and swing the door 180° before reinstalling. See <i>Reinstalling the Refrigerator Doors</i> .
There is an adjustment to rear wheels.	MYTH	Front leveling legs are adjustable and should be used to balance the refrigerator. Leveling legs are used to make initial fresh food door adjustment.
Check for leaks after all water connections are made.	TRUE	While purging the air from the water system, check all water line connections for leaks. Check the connection to the household water supply at back of refrigerator, and door water line connect.
My LCD display will always be on when I plug the power cord in at installation.	MYTH	If the refrigerator has been stored in a cold environment, the LCD may be slow to give a proper display. Give the refrigerator enough time to warm up, and the display should be okay.
Any packaging residue can be cleaned off the refrigerator using any cleaner.	MYTH	Do not use wax, polish, bleach, or other products containing chlorine on Stainless Steel panels, door handles and trim. Check this instruction under "Cleaning the Outside" for full details.

GET CONNECTED.



Manage your appliances from your computer or iPhone®

Combine a GE Brillion™ Get Connected Starter Kit with your Brillion-enabled refrigerator, and you'll have insight to help protect your investment and track your energy costs from your computer.

And that's just the beginning! With one GE Nucleus (included with the Get Connected Starter Kit), you can build a network of GE products enabled with Brillion technology—such as the GeoSpring water heater and the GE Programmable Thermostat—that you can manage from your computer or iPhone.

iPhone® is a registered trademark of Apple Inc.



Maintenance Alerts

Get text or email alerts if your Brillion-enabled appliances need attention, as well as reminders for regular maintenance like filter changes.



Remote Controls

Access your refrigerator's Sabbath Mode from your computer, and adjust GeoSpring and GE Thermostat settings from your computer or iPhone.



Energy Tracking

Track your appliances' energy usage.

Learn More at GEAppliances.com/connected-home-manager

SPECIAL OFFER

Save 25% on a GE Brillion Get Connected Starter Kit

- Call 800-694-8478, or
- Visit GEApplianceParts.com and enter the promotion code JOIN when you order the Get Connected Starter Kit (Part # HEKAE0U0V).

Offer valid through December 31, 2013



Refrigerator Warranty. *(For customers in the United States)*



All warranty service provided by our Factory Service Centers, or an authorized Customer Care® technician. To schedule service, visit us online at GEAppliances.com, or call 800.GE.CARES (800.432.2737). Please have serial number and model number available when calling for service.

Staple your receipt here. Proof of the original purchase date is needed to obtain service under the warranty.

Servicing your refrigerator may require the use of the onboard data port for diagnostics. This gives a GE Factory Service technician the ability to quickly diagnose any issues with your appliance and helps GE improve its products by providing GE with information on your appliance. If you do not want your appliance data to be sent to GE, please advise your technician NOT submit the data to GE at the time of service.

For the Period of:	GE Will Replace
GE PROFILE™ AND GE CAFÉ™ MODELS	
One Year <i>From the date of the original purchase</i>	Any part of the refrigerator which fails due to a defect in materials or workmanship. During the limited one-year warranty , GE will also provide, free of charge , all labor and related service to replace the defective part.
Thirty Days <i>(Water filter, if included) From the original purchase date of the refrigerator</i>	Any part of the water filter cartridge which fails due to a defect in materials or workmanship. During this limited thirty-day warranty , GE will also provide, free of charge , a replacement water filter cartridge.
GE PROFILE MODELS ONLY	
Five Years <i>(GE Profile models only) From the date of the purchase</i>	Any part of the sealed refrigerating system (the compressor, condenser, evaporator and all connecting tubing) which fails due to a defect in materials or workmanship. During this limited five-year sealed refrigerating system warranty , GE will also provide, free of charge , all labor and related service to replace the defective part in the sealed refrigerating system.

What GE Will Not Cover:

- Service trips to your home to teach you how to use the product.
- Improper installation, delivery or maintenance.
- Failure of the product if it is abused, misused, or used for other than the intended purpose or used commercially.
- Loss of food due to spoilage.
- Replacement of house fuses or resetting of circuit breakers.
- Damage caused after delivery.
- Replacement of the water filter cartridge, if included, due to water pressure that is outside the specified operating range or due to excessive sediment in the water supply.
- Replacement of the light bulbs, if included, or water filter cartridge, if included, other than as noted above.
- Damage to the product caused by accident, fire, floods or acts of God.
- Incidental or consequential damage caused by possible defects with this appliance.
- Product not accessible to provide required service.
- Damage caused by a non-GE Brand water filter.

EXCLUSION OF IMPLIED WARRANTIES—Your sole and exclusive remedy is product repair as provided in this Limited Warranty. Any implied warranties, including the implied warranties of merchantability or fitness for a particular purpose, are limited to one year or the shortest period allowed by law.

This warranty is extended to the original purchaser and any succeeding owner for products purchased for home use within the USA. If the product is located in an area where service by a GE Authorized Servicer is not available, you may be responsible for a trip charge or you may be required to bring the product to an Authorized GE Service location for service. In Alaska, the warranty excludes the cost of shipping or service calls to your home.

Some states do not allow the exclusion or limitation of incidental or consequential damages. This warranty gives you specific legal rights, and you may also have other rights which vary from state to state. To know what your legal rights are, consult your local or state consumer affairs office or your state's Attorney General.

Warrantor: General Electric Company, Louisville, KY 40225

Performance Data Sheet

Model: GE RPWF

Use Replacement Cartridge RPWF.

The concentration of the indicated substances in water entering the system was reduced to a concentration less than or equal to the permissible limit for water leaving the system as specified in NSF/ANSI Standard 42 and Standard 53. System tested and certified by NSF International against NSF/ANSI Standard 42 and Standard 53 for the reduction of substances listed below.

Capacity 170 Gallons (643.5 Liters). Contaminant Reduction Determined by NSF testing.

Substance Tested for Reduction	Average Influent	NSF specified Challenge Concentration	Avg % Reduction	Average Product Water Concentration	Max Permissible Product Water Concentration	NSF Reduction Requirements	NSF Test Report
Chlorine Taste and Odor	2.0 mg/L	2.0 mg/L ± 10%	97.4%	0.05 mg/L	N/A	≥50%	J-00102044
Nominal Particulate Class I, ≥0.5 to < 1.0 µm	7,633,333 pts/mL	At least 10,000 particles/mL	99.0%	71,850 pts/ml	N/A	≥85%	J-00106249
Asbestos	109 MFL	10 ⁷ to 10 ⁶ fibers/L; fibers greater than 10µm in length	99.99%	<1 MFL	N/A	≥99%	J-00102069
Atrazine	0.009 mg/L	0.009 mg/L ± 10%	94.4%	0.0005 mg/L	0.003 mg/L	N/A	J-00102058
Benzene	0.016 mg/L	0.015 mg/L ± 10%	96.4%	0.001 mg/L	0.005 mg/L	N/A	J-00102065
Carbofuran	0.08 mg/L	0.08 mg/L ± 10%	98.8%	0.001 mg/L	0.04 mg/L	N/A	J-00102059
Cyst*	104,750 cysts/L	Minimum 50,000 cysts/L	99.99%	3 cyst/L	N/A	≥99.95%	J-00102057
Lead pH @6.5	0.140 mg/L	0.15 mg/L ± 10%	99.3%	0.001 mg/L	0.010 mg/L	N/A	J-00102052
Lead pH @8.5	0.158 mg/L	0.15 mg/L ± 10%	98.3%	0.002 mg/L	0.010 mg/L	N/A	J-00102053
Mercury @ pH 6.5	0.006 mg/L	0.006 mg/L ± 10%	91%	0.0003 mg/L	0.002 mg/L	N/A	J-00102054
Mercury @ pH 8.5	0.006 mg/L	0.006 mg/L ± 10%	88.3%	0.0007 mg/L	0.002 mg/L	N/A	J-00104087
Lindane	0.002 mg/L	0.002 mg/L ± 10%	99%	0.00002 mg/L	0.0002 mg/L	N/A	J-00102063
P-Dichlorobenzene	0.222 mg/L	0.225 mg/L ± 10%	99.8%	0.0005 mg/L	0.075 mg/L	N/A	J-00102067
Toxaphene	0.015 mg/L	0.015 mg/L ± 10%	93.5%	0.001 mg/L	0.003 mg/L	N/A	J-00102061
2, 4-D Reduction	0.218 mg/L	0.210 mg/L ± 10%	99.9%	0.0001 mg/L	0.07 mg/L	N/A	J-00102064
VOC	0.278 mg/L	0.300 mg/L ± 10%	97.7%	0.0015 mg/L	N/A	≥95%	J-00102070

*Based on the use of Cryptosporidium parvum oocysts.

The following pharmaceutical reduction claims have not been certified by NSF International. Claims tested and verified by independent laboratory:

Contaminant Reduction	Average Influent	NSF specified Challenge Concentration	Avg % Reduction	Average Product Water Concentration	Max Permissible Product Water Concentration	NSF Test Report
Atenolol	1088 ng/L	N/A	99.5%	5.0 ng/L	N/A	J-00103221
Fluoxetine	845 ng/l	N/A	99.4%	5.0 ng/L	N/A	J-00103221
Ibuprofen	898 ng/L	N/A	98.8%	9.9 ng/L	N/A	J-00103726
Progesterone	945 ng/L	N/A	99.4%	5.5 ng/L	N/A	J-00103727
Trimethoprim	403 ng/L	N/A	99.5%	2.0 ng/L	N/A	J-00103221

Application Guidelines/Water Supply Parameters

Service Flow	0.5 gpm (1.89 lpm)	Water Pressure	25-120 psi (172- 827 kPa)
Water Supply	Potable Water	Water Temperature	33° F - 100° F (0.6° C - 38° C)

It is essential that the manufacturer's recommended installation, maintenance and filter replacement requirements be carried out for the product to perform as advertised. See Installation Manual for Warranty information.

Note: While the testing was performed under standard laboratory conditions, actual performance may vary.

Replacement Cartridge: RPWF. For estimated costs of replacement elements please call 1-800-626-2002 or visit our website at www.geapplianceparts.com.

⚠ WARNING

To reduce the risk associated with ingestion of contaminants:

- Do not use with water that is microbiologically unsafe or of unknown quality without adequate disinfection before and after the system. Systems certified for cyst reduction may be used on disinfected water that may contain filterable cysts. EPA Establishment Number 070595-MEX-001.

NOTICE

To reduce the risk associated with property damage due to water leakage:

- Read and follow use instructions before installation and use of this system.
- Installation and use **MUST** comply with all state and local plumbing codes.
- Do not install if water pressure exceeds 120 psi (827 kPa). If your water pressure

exceeds 80 psi, you **must** install a pressure-limiting valve. Contact a plumbing professional if you are uncertain how to check your water pressure.

- Do not install where water hammer conditions may occur. If water hammer conditions exist you **must** install a water hammer arrester. Contact a plumbing professional if you are uncertain how to check for this condition.
- Do not install on hot water supply lines. The maximum operating water temperature of this filter system is 100° F (38° C).
- **Protect filter from freezing.** Drain filter when temperatures drop below 33°F (0.6°C).
- The disposable filter cartridge **must** be replaced every 6 months at the rated capacity, or sooner if a noticeable reduction in flow rate occurs.

For conditions of use, health claims certified by the California Department of Public Health, and replacements, see performance data sheet. California Department of Public Health Certification #11-2110. The contaminants or other substances removed or reduced by this water filter are not necessarily in all users' water.



GE
Appliances
Appliance Park
Louisville, KY 40225
geapplianceparts.com



System tested and certified by NSF International against NSF/ANSI Standard 42 and Standard 53 in model GE RPWF for the reduction of the claims specified on the performance data sheet.

34-8708-7119-0

EPA #070595-MEX-001

© 2012 General Electric Company PC71879

State of California
Department of Public Health
Water Treatment Device
Certificate Number
11-2110

Date Issued: November 16, 2011

Trademark/Model Designation

GE RPWF

Replacement Elements

RPWF

Manufacturer: 3M Purification Inc.

The water treatment device(s) listed on this certificate have met the testing requirements pursuant to Section 116830 of the Health and Safety Code for the following health related contaminants:

Microbiological Contaminants and Turbidity

Cysts

Inorganic/Radiological Contaminants

Asbestos

Lead

Mercury

Organic Contaminants

Atrazine

Benzene

Carbofuran

Lindane

p-Dichlorobenzene

Toxaphene

2,4-D

VOC's by chloroform surrogate

CA AB1953 Low Lead Compliant

Rated Service Capacity: 170 gallons

Rated Service Flow: 0.5 gpm

Conditions of Certification:

Do not use where water is microbiologically unsafe or with water of unknown quality, except that systems certified for cyst reduction may be used on disinfected waters that may contain filterable cysts.

Consumer Support.



GE Appliances Website

In the U.S.: *GEAppliances.com*

Have a question or need assistance with your appliance? Try the GE Appliances website, 24 hours a day, any day of the year! For greater convenience and faster service, you can now download Owner's Manuals, order parts or even schedule service on-line. In Canada: www.GEAppliances.ca



Schedule Service

In the U.S.: *GEAppliances.com*

Expert GE repair service is only one step away from your door. Get on-line and schedule your service at your convenience any day of the year! Or call 800.GE.CARES (800.432.2737) during normal business hours.

In Canada, call 1.800.561.3344



Real Life Design Studio

In the U.S.: *GEAppliances.com*

GE supports the Universal Design concept—products, services and environments that can be used by people of all ages, sizes and capabilities. We recognize the need to design for a wide range of physical and mental abilities and impairments. For details of GE's Universal Design applications, including kitchen design ideas for people with disabilities, check out our Website today. For the hearing impaired, please call 800.TDD.GEAC (800.833.4322).

In Canada, contact: Manager, Consumer Relations, Mabe Canada Inc.
Suite 310, 1 Factory Lane
Moncton, N.B. E1C 9M3



Extended Warranties

In the U.S.: *GEAppliances.com*

Purchase a GE extended warranty and learn about special discounts that are available while your warranty is still in effect. You can purchase it on-line anytime, or call 800.626.2224 during normal business hours. GE Consumer Home Services will still be there after your warranty expires. In Canada, call 1.888.261.2133



Parts and Accessories

In the U.S.: *GEAppliances.com*

Individuals qualified to service their own appliances can have parts or accessories sent directly to their homes (VISA, MasterCard and Discover cards are accepted). Order on-line today, 24 hours every day or by phone at 800.626.2002 during normal business hours.

Instructions contained in this manual cover procedures to be performed by any user. Other servicing generally should be referred to qualified service personnel. Caution must be exercised, since improper servicing may cause unsafe operation.

Customers in Canada should consult the yellow pages for the nearest Mabe service center, or call 1.800.661.1616.