

This Owner's Manual is provided and hosted by [Appliance Factory Parts](#).



Haier RBFS21TIAE Owner's Manual

[Shop genuine replacement parts for Haier RBFS21TIAE](#)



[Find Your Haier Refrigerator Parts - Select From 1148 Models](#)

----- Manual continues below -----

Haier











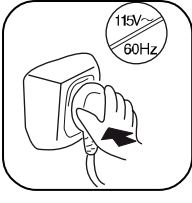

Household Refrigerator

Model: PBFS21****

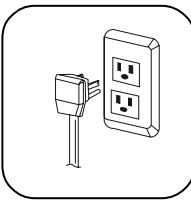
Table of Contents

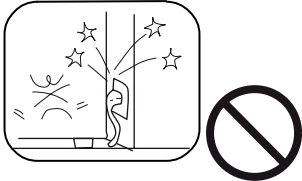
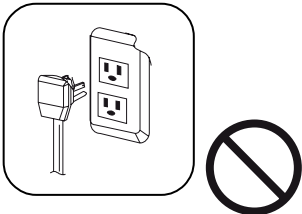
Safety Precautions -----	1-2
Location-----	3
Featured functions-----	3
Parts & Components-----	4
Door Removal and Replacement-----	5-6
Connecting Water Supply-----	7-8
Preparation before Usage-----	9
Start Using-----	9
Functions-----	10-14
About Refrigerator compartment -----	15-16
Precautions when Refrigerating Food-----	16
Tips & Hints for Using Refrigerator compartment-----	17
About the Freezer Drawer -----	17
Precaution when Freezing Food-----	18
Usage of Ice Maker, Cold Water Dispenser -----	18-19
Operation of Ice Maker-----	19
Operation of Cold Water Dispenser-----	20
Precaution when Using Cold Water Dispenser-----	20
Defrosting & Cleaning -----	21
Water Filter -----	22
Stopping -----	23
Troubleshooting -----	24-27
Limited Warranty -----	28

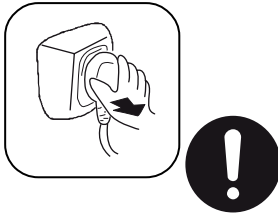
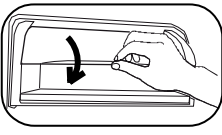
Safety Precautions

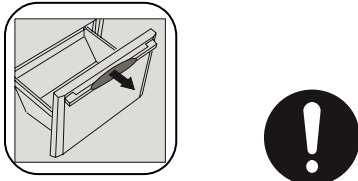
 WARNING	<p>Before operating the appliance, please read through this manual carefully and retain it for future reference. Because we offer a variety of models, the characteristics of your refrigerator may differ slightly from those described in this manual. The appliance is not intended for use by children or infirm persons without adult supervision. Children should be supervised to ensure that they do not play with the appliance.</p>	
 WARNING	<p>Indicates that a danger of death or serious injury exists.</p>	
 NOTE	<p>Indicates that a risk of personal injury or material damage exists.</p>	
	<p>Represents something you must follow.</p>	
	<p>Represents something you must not do.</p>	
<p>This refrigerator uses AC 115/60Hz power Large voltage fluctuation may cause no start-up of the refrigerator, burning of main control board and compressor or abnormal noise in the compressor, in such case, an auto stabilizer is needed.</p>	<p>A separated socket is a must and reliable grounding is needed as well This refrigerator adopts three-prong (grounding) plug, which can be used on standard three-prong (socket). In any case, cutting off or dismantling the third pin (grounding) is prohibited. After the refrigerator is installed, the plug shall be reachable.</p>	<p>Do not damage the power cord</p> <ul style="list-style-type: none"> Do not disconnect the power cord by pulling on it. hold the plug, draw it out from the socket directly. Refrigerator pressing the cord is not allowed. Do not step on the cord. When you move the refrigerator away from the wall, be careful and avoid rolling and pressing the cord.
 	 	
<p>In case power cord is damaged If the cord or the plug is worn, stop using it. contact a qualified service engineer to replace it.</p> 	<p>In case there is flammable gas leakage</p> <ul style="list-style-type: none"> Shut the valve where there is gas leakage. Open doors and windows. Do not pull out or insert the power plug of the refrigerator or any other appliances. 	<p>Unplug the refrigerator in the following cases</p> <ul style="list-style-type: none"> Before cleaning or maintenance of the refrigerator. Before changing damaged light bulb. 
<p>When you open or close the dairy bin, please do as per shown in the following figure to prevent pinching your fingers.</p>  		<p>Do not put too much food in the freezer compartment, otherwise the compressor may run for extra time, and food may fall out. Handle with care when opening or closing the freezer compartment to avoid food falling out.</p> 

Safety Precautions

Do not put dangerous materials such as flammable, explosive matters, high corrosive acid and alkali in your refrigerator.



Do not put drugs, vaccines and other chemical agents in your refrigerator which is designed for household usage only and not capable of storing materials which have strict temperature requirements.

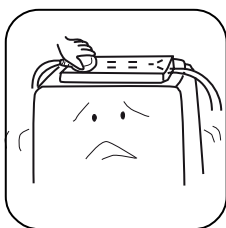

Do not risk storing or using flammable materials such as gasoline near the refrigerator which may lead to fire hazard.

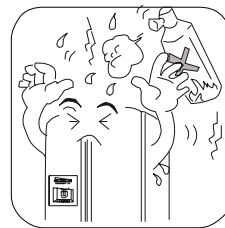

Do not put unstable objects (objects which are either heavy or contains water) on top of the refrigerator, as they may fall and cause injury or electric shock hazard.

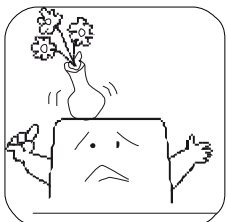

Do not swing the door by holding the bottle bins, otherwise the door and bottle bin may get damaged. Do not step on the door or cabin of the convertible drawer when accessing food.



While the refrigerator is in operation, do not touch the frozen surfaces of the freezer, especially with wet hands, or you hands may get frostbitten.

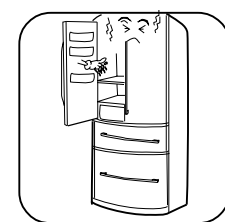

The clearances between doors and the cabinets are very tight, mind not to reach your hands in between these areas, in case your fingers may get pinched. While operation the doors, please keep kids away from the refrigerator.



Do not try to clean the refrigerator by flushing or pouring water, neither should you sit the refrigerator in a humid environment, these will reduce the electrical isolation performance of the machine.

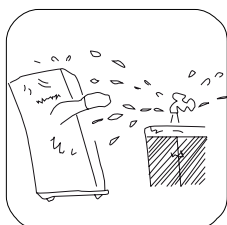

Do not try to dismantle or improve the refrigerator, nor should you operate it with greater force. Take care not to damage the piping of the machine, risk of property loss or injury may arise. Maintenance of the machine must be carried out by professionals.

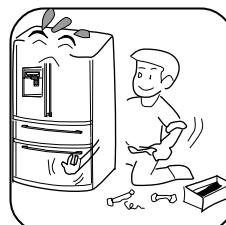

Do not keep beers and other drinks in bottles which may be cracked down by low temperature in the freezer compartment. When using the convertible compartment as freezer, please also observe the above instructions.

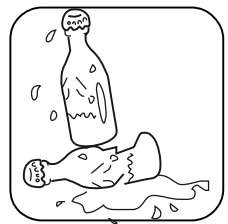

Unplug the refrigerator at power failure or cleaning. Keep the machine unplugged for at least 5 minutes before it's plugged again, otherwise the compressor may be damaged due to successive startups.

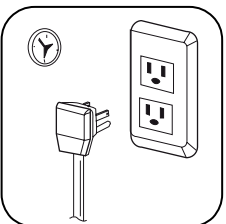

Before disposing your old refrigerator, make sure to remove the doors along with its gaskets, and the selves within the refrigerator, and dispose them properly, so that children may not get hurt when playing with it.

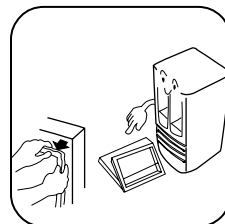

Location

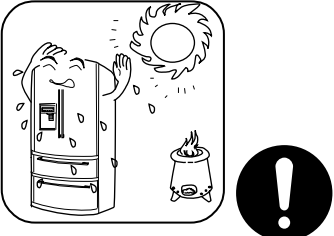
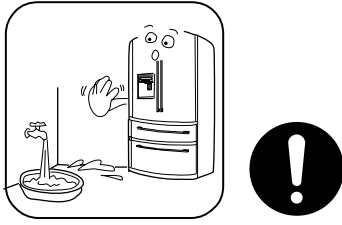
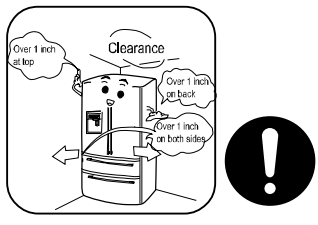
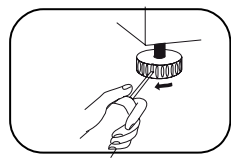
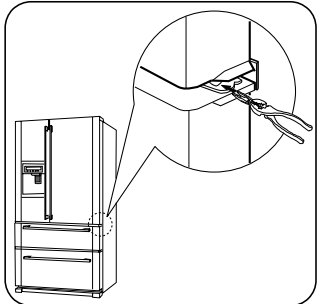
<p>Keep your refrigerator away from heat source or direct sunlight which may reduce the cooling performance of the refrigerator.</p> 	<p>Keep your refrigerator away from humid places and where it's easily get spilled. Wipe off spills immediately.</p> 	<p>Sit the refrigerator at a well ventilated place, where portable water source is easily accessible. Allow at least one inch clearance around each surface of the refrigerator.</p> 
<p>Leveling: The refrigerator should sit on firm, flat floor. If you need to raise it by sitting it on pads, please choose something firm and flat, and not inflammable. Do not use packing foams as platform for refrigerator to sit on. If the refrigerator can not obtain well alignment, you can adjust it by leveling the adjustable feet. Turn the feet clockwise to raise the cabinet, and vice versa to lower it</p> 	<p>Door alignment: If the doors are not well aligned, please follow the instructions hereunder:</p> <ol style="list-style-type: none"> 1. Lift the door which is need to be lifted by holding it at the middle hinge; 2. Apply pliers to insert spacer clip rings in place as shown in the figure; 3. Insert more spacer clip rings till the door obtains well alignment. (3 spacer clip rings were shipped with each machine) 	

Featured functions

1. Water filter: Super large purification capacity, easy removal and replacement design.
2. Dedicated Ice Bin: Convenient drawer type ice bin for your access.
3. Super slim, super large, super luxury:
Super slim overall dimensions, super large capacity for refrigeration and freezing, luxury high-end tempered glass shelves within refrigerator compartment, super large crisper.
4. Freon free, frost free, total air cooling system, equipped with fast deep freezing capability.
5. Air curtain technology:
With the unique air curtain located on the front end of the refrigerator compartment, it's optimized to reduce heat loss when the door is opened, further more to help with a more evenly cooling air delivery within the cabin, thus to guarantee a better cooling result.
6. Pre-cooling measurement for defrosting procedure:
Cabin temperature will be calculated automatically with the intention to retain less temperature changes during defrosting procedure, the refrigerator will start a pre-cooling targeting better cooling of food by eliminate obvious temperature rise during defrosting.
7. Automatic error alert
8. Door alert
9. Full-width convertible drawer for cooked food:
Within the temperature range of -2°C to -3°C, the cooked food stored therein can be prepared without having to thaw.

Parts & Components

Refrigerator compartment

Refrigerator light

Refrigerator compartment

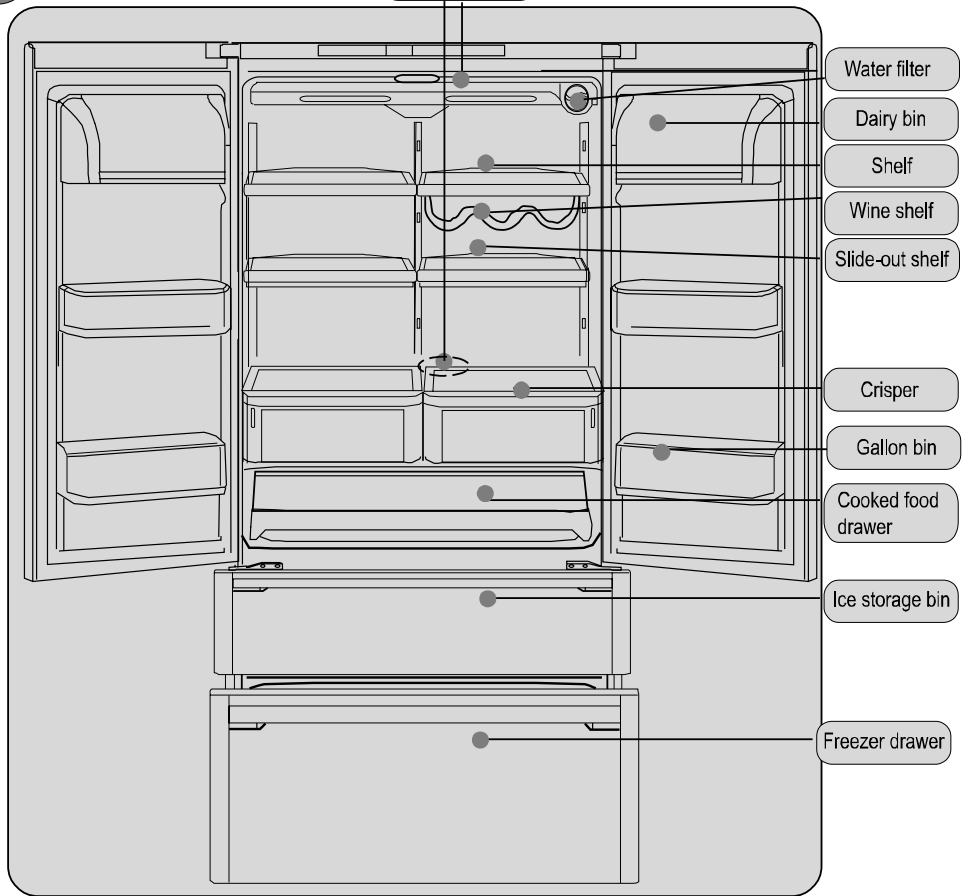

Freezer compartment

Drawer separator

Freezer drawer

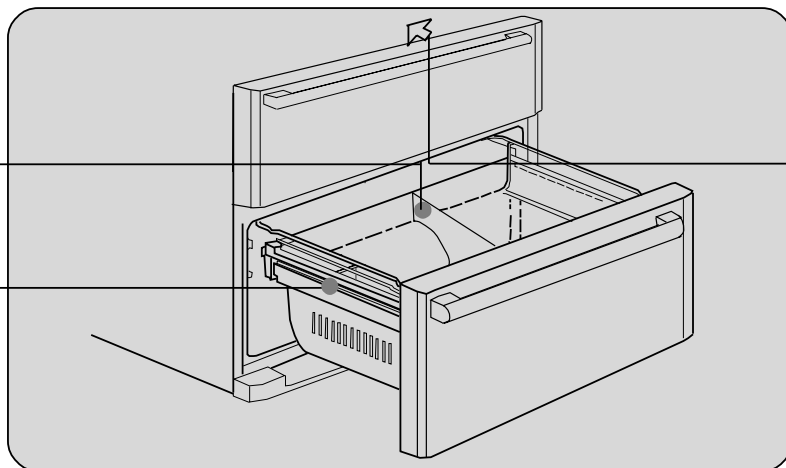

NOTE

There're a variety of different optional accessories for this refrigerator, hence the figures shown in this manual may not be identical with your refrigerator.

Door Removal and Replacement



NOTE

- To avoid injury and property loss, damage to the refrigerator, before removal and replacement of door(s), make sure to remove all food from shelves, then, remove bottle bin(s), unplug the refrigerator, shut off water supply.
- Have 2 or more friends for help if possible. Please follow the instructions below.

Refrigerator compartment door removal and replacement:

1

Remove the screws of the decoration trim by means of screw driver, and then remove the trim.

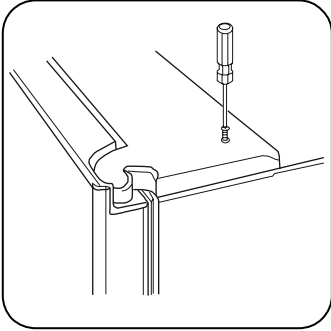

2

Remove the screws from the upper hinge, remove the upper hinge, then, remove the refrigerator door and place it at a proper location.

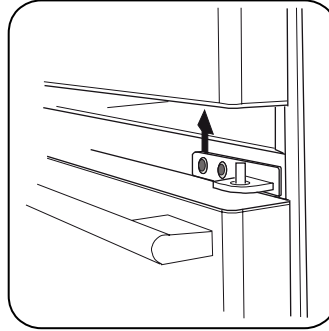
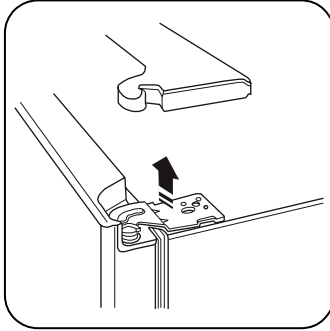

3

Remove the middle hinge if necessary.

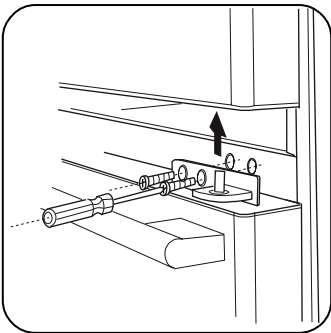

4

Replace the door in a reversal sequence to the above steps.



NOTE

Take care to prevent the door from falling onto you when lifting the hinges to remove the door.

Left refrigerator door removal and replacement

1

Follow instructions of the first step in 'Refrigerator compartment door removal and replacement' section;

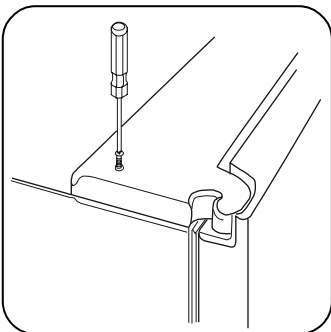

2

Remove the screws from the upper hinge, remove the upper hinge, then, remove the refrigerator door and place it at a proper location.

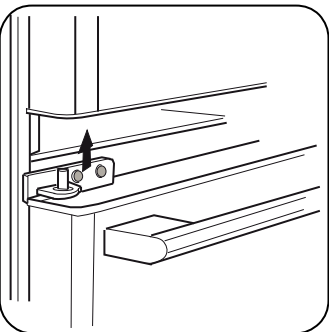
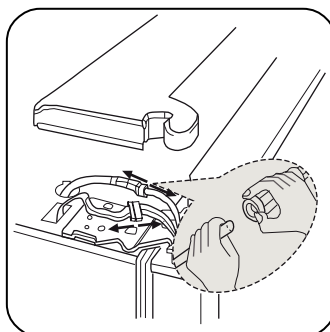

Door Removal and Replacement

3

Remove the middle hinge if necessary.

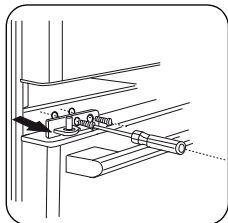

4

Replace the door in a reversal sequence to the above steps.



NOTE

Take care to prevent the door from falling onto you when lifting the hinges to remove the door.

Ice storage drawer removal and replacement:

1

Pull the ice storage open to the most, and take it out.

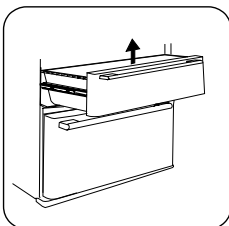

2

Hold the release buckles on the slide rail in a direction as shown in the figure, then, lift and pull the front panel of the drawer out.

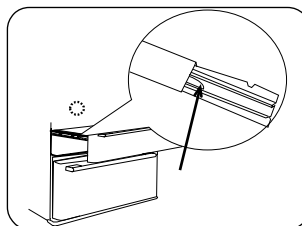

3

Replace the drawer in a reversal sequence to the above steps.

Freezer drawer removal and replacement

1

Pull the drawer open to the most, and take it out.

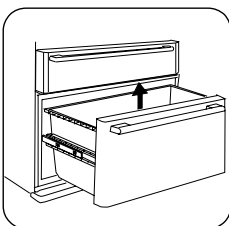

2

Hold the release buckles on the slide rail in a direction as shown in the figure, then, lift and pull the front panel of the drawer out.

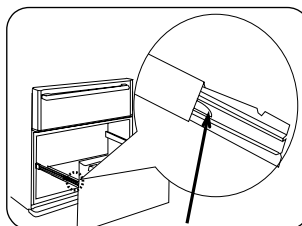

3

Replace the drawer in a reversal sequence to the above steps.



WARNING

To prevent choke hazard, keep children and pets away from the drawers, in case they may get entrapped in the drawers.

Connecting Water Supply

1

Connect the refrigerator to nearest shutoff valve on a water line in use.

Turn off the main water supply.

Turn ON nearest faucet long enough to clear line of water.

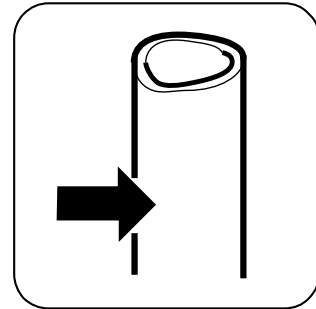

2

Locate a proper installation position for the shutoff valve:

Find a convenient position on a vertical pipe. Horizontal pipe will work, but connections must be made to the top side of the pipe, not the bottom. This will keep normal sediment from collecting in the valve.

3

Drill a installation hole for the valve

Drill a quarter inch hole in the water pipe (even if a shutoff valve with self-tapping connection is applied), and remove burrs left on around the drilled hole.

Make sure water does not get into the valve.

Fail to drill this hole will result in insufficient ice production or smaller ice cube.

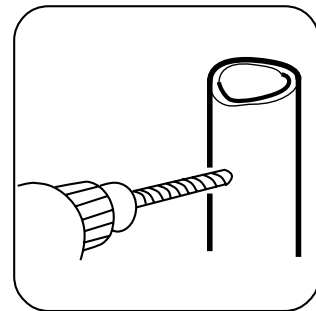

4

Fasten shutoff valve:

fasten shutoff valve to cold water pipe with pipe clamp. Before installation, please make sure a saddle-type valve complies with your local plumbing codes. According to Commonwealth of Massachusetts plumbing codes CMR248, saddle valves are illegal and use of it is prohibited. Please consult a licensed plumber.

5

Tighten the pipe clamp:

Tighten the pipe clamp till the washer starts to swell.

Do not over-tighten or you may crash the tubing.

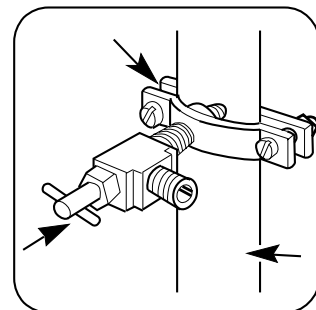

Connecting Water Supply

6

Route the tubing:

Route the tubing between the cold water line and the refrigerator. Route the tubing through a hole drilled in the wall or floor (behind the refrigerator or adjacent to its base cabinet) as close to the wall as possible.

Be sure there is sufficient extra tubing (about 8 feet [2.4m] rolled into 3 turns of 10 inches[25cm] each) to allow the refrigerator to move out from the wall after installation.

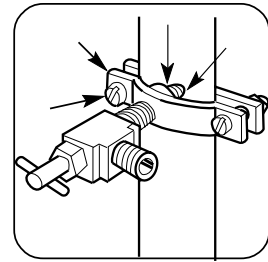

7

Connect tubing to the valve:

Connect the compression nut and the copper sleeve to the end of tubing, and connect it to the shutoff valve.

Make sure the tubing is pushed into the valve as far as it will go, then tighten the nut securely.

According to Commonwealth of Massachusetts plumbing codes CMR248, saddle valves are illegal and use of it is prohibited. Please consult a licensed plumber.

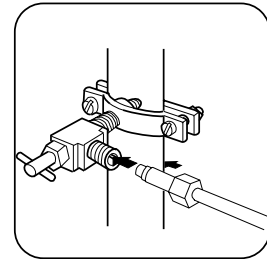

8

Flush the tubing:

Turn on the main water supply valve to flush water through the tubing until water is clear.

Shut off the valve when about 1 quart (1L) water has been flushed through the tubing.

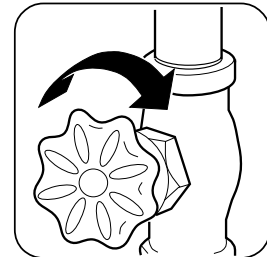

9

Connect tubing to the refrigerator:



NOTE

Before carrying out further action, make sure the power plug is not connected to wall outlet.

1. Remove the compression nut from the water valve;
2. Push the end of tubing onto the water valve, then, tighten it with the nut.

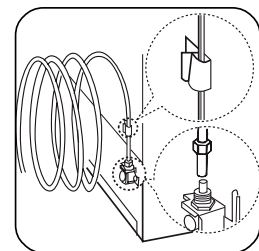

Preparation before Usage

1

Remove the packing

Remove the foam support and all adhesive tapes used to retain accessories.

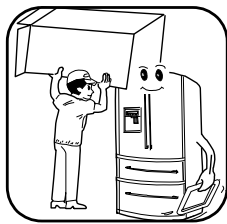

2

Check accessories and documents:

Check accessories and documents according to the packing list. Call the dealer if anything's left out.

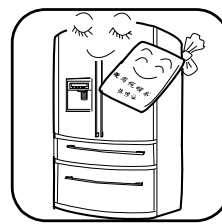

3

Install your refrigerator in proper location:

Refer to 'Location' section for details.

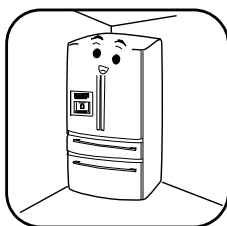

4

Install bottom trim kit:

Take the bottom trim kit out from the refrigerator compartment, and install and fasten it with screws to the position as shown in the figure.

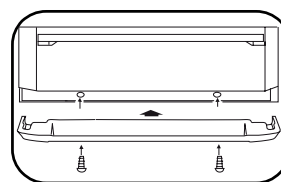

NOTE

Take down the model number and serial number of the machine on warranty certificate for future information query.

5

Clean before using:

Before storing food in the refrigerator, please clean the interior and exterior surface of the machine with soda solution (one spoon of soda into 4 L water).



6

Stand still:

After the refrigerator is installed and cleaned, allow 6 hours before connecting the mains, thus to obtain proper operation of the machine.

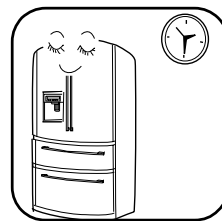

Start using

1

Connect to mains:

At first start-up, both refrigeration and freezing controls will be set to 4 automatically.

2

Temperature setting mode:

Manual setting mode: allow manual temperature setting by operating temperature adjustment keys. Please refer to the later 'Function' section for details.

3

Temperature setting mode:

Manual setting mode: allow manual temperature setting by operating temperature adjustment keys. Please refer to the later 'Function' section for details.



NOTE

It takes time for the temperature to change according to change of settings. The actual length needed depends on how much change of settings were made, the ambient temperature there is, openings of the door(s), and how much food is stored in the refrigerator.

Functions

Door controls with display

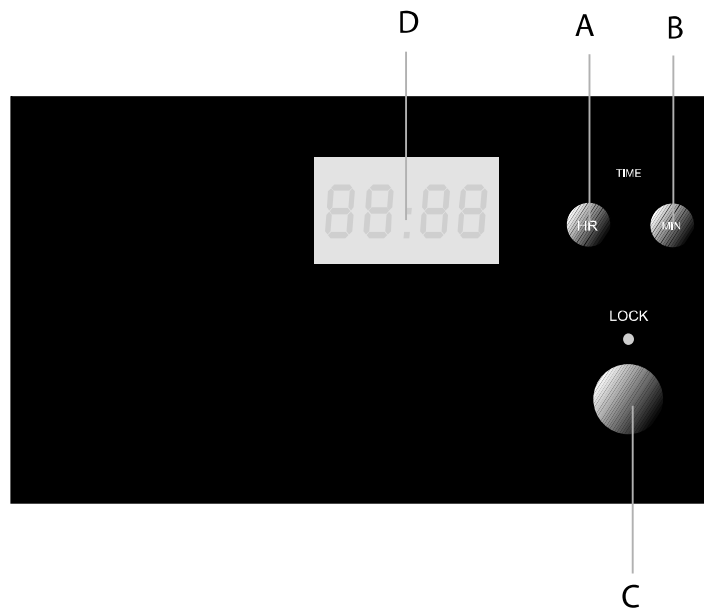

A.....Hour key; B.....Minute key; C.....Lock key; D.....Clock display.

Cabinet controls with display

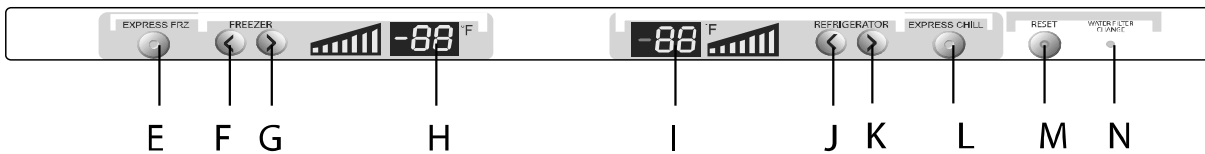

(Only applicable to PBFS21**** series)

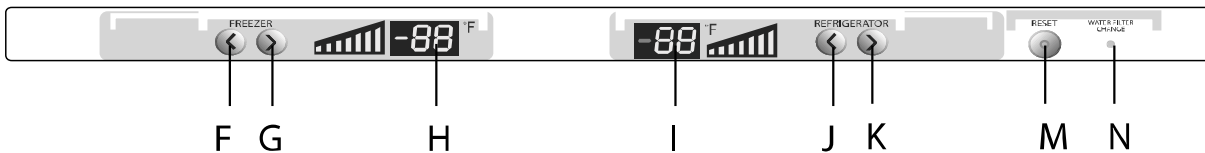

(Only applicable to PBFS21**** series)

- E.....Fast deep freezing of freezer compartment;
- F, G.....Temperature adjustment key of freezer compartment;
- H.....Temperature indicator of freezer compartment;
- I.....Temperature indicator of refrigerator compartment;
- J, K.....Temperature adjustment key of freezer compartment;
- L.....Fast cooling of refrigerator compartment;
- M.....Water filter alert reset key;
- N.....Water filter alert.

1

Lock and unlock:

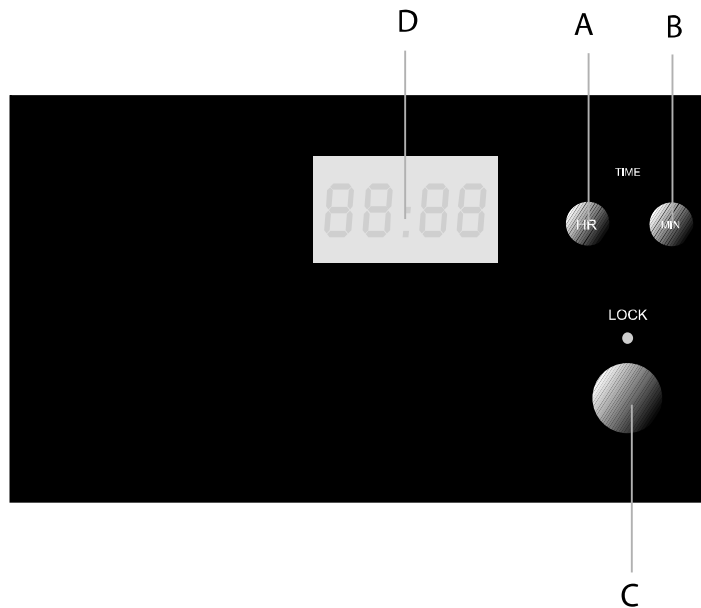

Press C key, the LOCK key will light up, the refrigerator will turn to lock mode. Press C key again to release lock mode, and the LOCK key will go off.

2

Temperature adjustment of refrigerator compartment

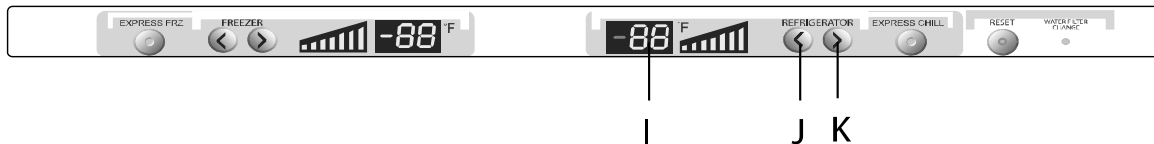

(Only applicable to PBFS21**** series)

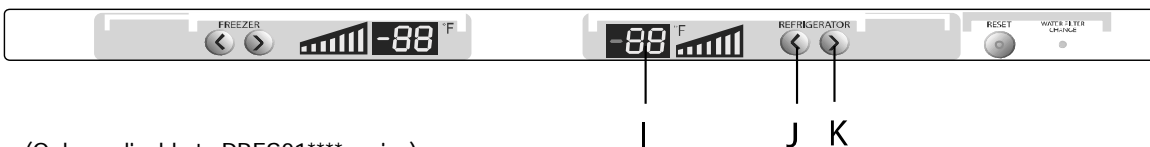

(Only applicable to PBFS21**** series)

Press key J or K once, temperature indicator 'I' of refrigerator compartment will blink, the refrigerator will turn to refrigerator compartment temperature adjustment mode. Temperature range of the refrigerator compartment is 36°F-48°F. Upon each K key operation, temperature setting will increase one level, from 1 till 7; temperature setting decreases one level upon J key operation.

3

Temperature adjustment of freezer compartment



(Only applicable to PBFS21**** series)

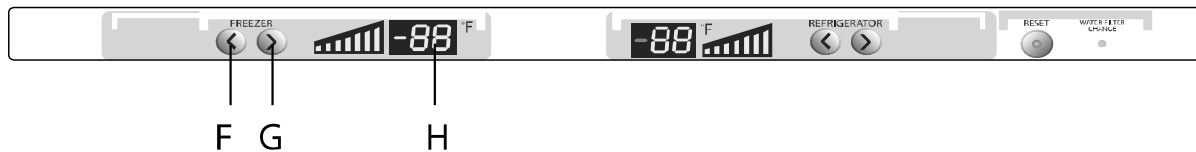

(Only applicable to PBFS21**** series)

Press key G or F once, temperature indicator 'H' of freezer compartment will blink, the refrigerator will turn to freezer compartment temperature adjustment mode. Temperature range of the refrigerator compartment is -5°F- -9°F. Upon each G key operation, temperature setting will increase one level, from 1 till 7; temperature setting decreases one level upon F key operation.

4

Adjustment of door clock display

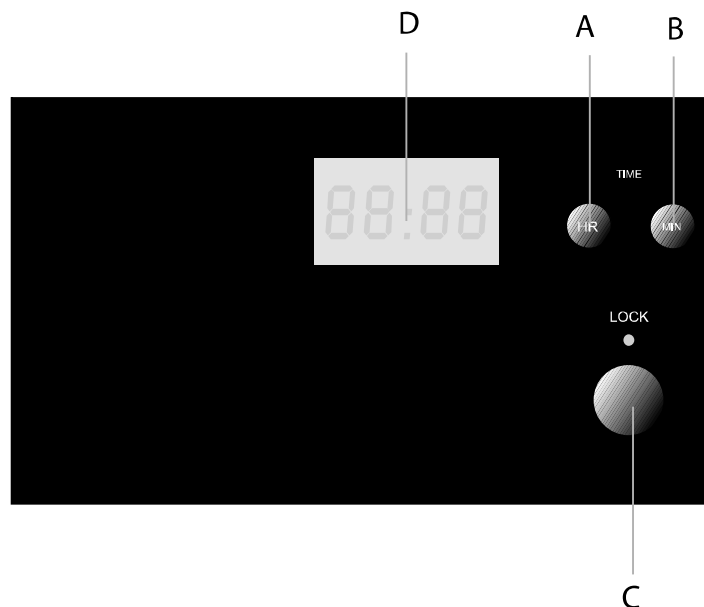

Hold down key A and B at the same time, clock display will light up. HR value changes from 0 till 24, MIN value changes from 0 to 60.

Functions

5 Fast deep freezing of freezer compartment

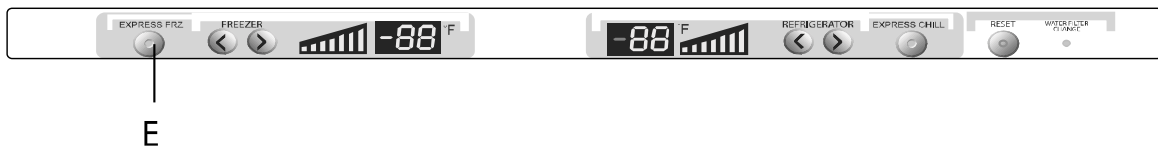

This function is designed to help you with an optimized food storing, capable of freezing food completely deep to the core within a short period of time.

Press key E once, the indicator will start to blink, the freezer will turn to fast deep freezing mode. The freezer will automatically restore normal operation mode after 4 hours' fast deep freezing operation. You can stop fast freezing any time by pressing key E again—indicator will go off, and normal operation restored.

6 Fast cooling of refrigerator compartment

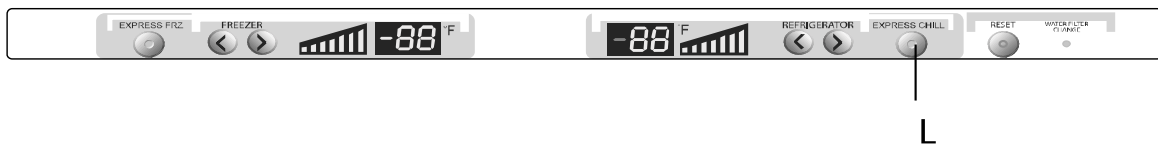

Press key L once, the indicator will start to blink, the refrigerator compartment will turn to fast cooling mode. The refrigerator will automatically restore normal operation mode after 4 hours fast cooling operation. You can stop fast cooling any time by pressing key E again—indicator will go off, and normal operation restored.

7 Water filter alert

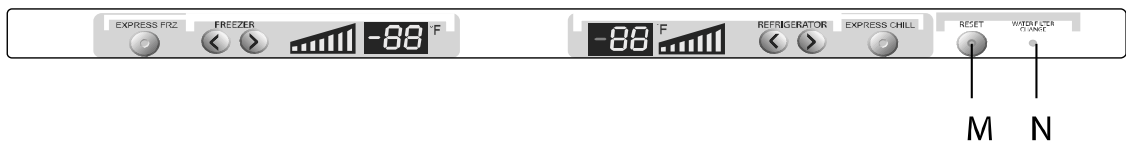

(Only applicable to PBFS21**** series)

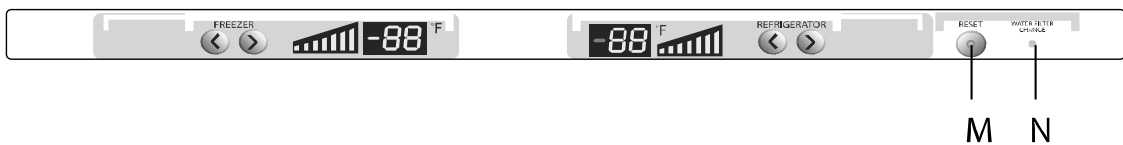

(Only applicable to PBFS21**** series)

When this alert indicator N lights up, you should change the water filter. When new filter is replaced, press key M, the indicator will go off.



NOTE

Please refer to 'Water filter' section for details on changing water filter.

8

Controls display:

After 30 seconds' idle, the display will go off automatically. By pressing any key, or opening any door or operating cold water dispenser, it will light up again.

9

Errors:

When there's malfunction, by pressing any key, there will be no response except the warning tone can be heard. The refrigerator still can perform cooling functions. Please contact after-service as soon as possible for help, to maintain normal operation of the refrigerator.

10

Door alert:

3 minutes after opening of any door, the refrigerator will give alarm sound to alert that some door(s) is left open. As for doors of refrigeration and freezer compartments, this alarm will take place 60 seconds after they're left open.

11

Over voltage protection:

Your refrigerator is equipped with over voltage protection measurements. When activated, the protection will cut the power for 5 minutes before reconnection.

About Refrigerator compartment

Temporary storage or frequent foods should be kept in the refrigerator compartment.

Although in most areas inside the refrigerator compartment, an average temperature of 36°F- 48°F can be obtained through adjusting the temperature settings, this compartment is not intended for long-term fresh keeping. So, keep in mind refrigerator compartment is only for temporary storage.

Height-adjustable shelves

You can adjust the height of shelves which are supported by removable support arms.

Remove the shelf to adjust first—remove the shelf by lifting it up and pull out. Replace it by inserting its hook end into the retaining holes, then replace the shelf.



NOTE

Make sure the shelves are placed evenly, fail to do so may cause the selves or food falling out.

Crisper

The crisper features humidity adjustment function, which will meet your specific need for food storing.

- Dial up the humidity knob located on the right side of the crisper to maintain a higher humidity. Suitable for storing cucumbers, grapes, kiwi fruits and persimmon etc.
- Dial down the humidity knob to maintain a lower humidity. Suitable for storing strawberry, orange, green bean, garlic stem, watermelon, plum and tomato etc.
- When removing the crisper, make sure the front edge of its cover board is within the crisper, then you can pull the crisper out. Remove the cover board only when the crisper is already removed. Also, replace the cover board before replacing the crisper.

Cooked food drawer

Your refrigerator is equipped with cooked food drawer, when removing it:

- Take out the cover board;
- Remove the drawer.

High bottle bin adjustment and its cleaning

Lift the bottle bin as shown in direction (1), hold both side and pull it out in direction (2).

After cleaning, replace the bottle bin to original position or change to other positions as you need.

Removal of crisper cover board

Lift the crisper cover board as shown in direction (1), pull it out in direction (2).

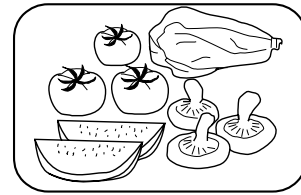

Removal

Lift up and remove

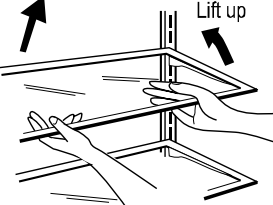

Replacement

Upper hook

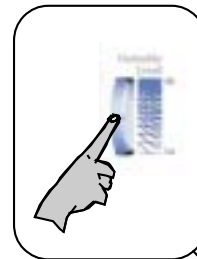
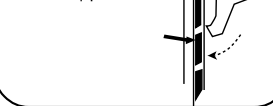

Temperature control

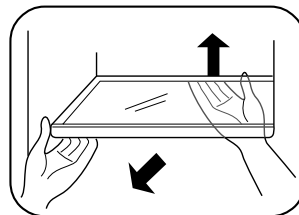
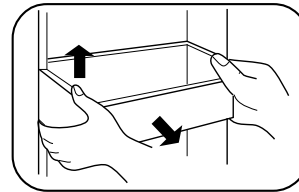

NOTE

While adjusting bottle bin height, do not install dairy bin, gallon bin and other bins to the lower part of the door, in case they may bump the drawers and leave it difficult to close the door tightly.

About Refrigerator compartment

Recommended storage area for various food

Out of the nature of the cooling air circulation, temperature in different area of the refrigerator will vary slightly. Hence, it is recommended to store different food in different area:

1. Eggs, butter, cheese;
2. Tinned drinks, food, spices;
3. Bottled drinks and food;
4. Salted food, cans;
5. Meat and snack food;
6. Bread, can, milk, tofu;
7. Cooked meat, sausages;
8. Fruits, vegetables, salads.

Lamp replacement for refrigerator compartment

Lamp specifications: AC 115V, 40W;

Socket type: E17 (DO NOT use a bulb of over 40W);

Replacement procedure:

- Unplug from wall outlet;
- 1. Press down the stopper pin, until it's removed from the square hole;
- 2. Hold the lamp cover and pull it out.
- Screw counter clockwise to remove the bulb from socket. Replace new bulb of the same specifications by screwing it clockwise into the socket.
- Replace lamp cover: insert the jaws into the square hole, then push the rear part of the lamp cover until the stopper pin is clicked into position.

Air curtain removal and replacement

- Unplug from wall outlet;
- Removal:
 1. Take off the water filter;
 2. Take off the lamp cover and the bulb;
 3. Remove screws used to fasten the air curtain by means of screwdriver;
 4. Remove the air curtain device by pulling it downwards gently.
- Replace parts in a reverse sequence.

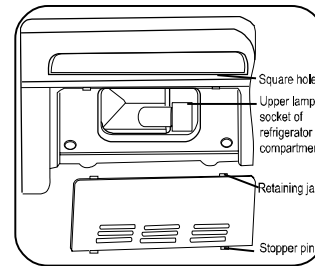
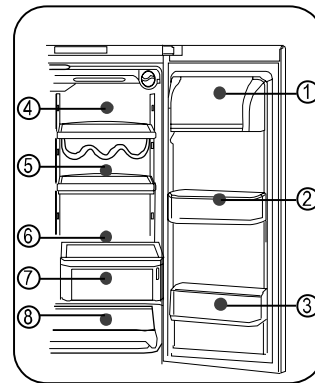



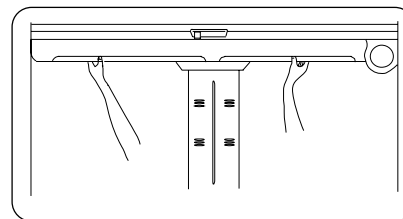

Light bulb of refrigerator compartment



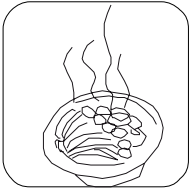

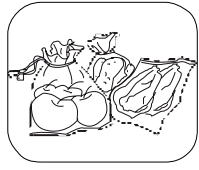
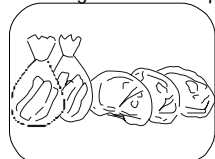
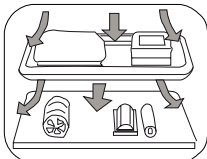
Removal of air curtain

Precautions when Refrigerating Food

<p>Allow food to cool down to ambient temperature before adding to the refrigerator.</p> 	<p>Before adding food into refrigerator, wipe the surface of food packing clean.</p> 	<p>Wrap food before adding it to the refrigerator This will help prevent water loss of the food, and provide better fresh keeping effects, further more to prevent odor transfer.</p> 
<p>Sort food before adding to the refrigerator Sort the food according to its type before adding it to the refrigerator. Put frequent food at the front side of the shelves. This can greatly help to reduce time needed to search for food, and will help to reduce chances that food is left forgotten in the refrigerator till it's spoiled.</p> 	<p>Do not overfill your refrigerator Leave sufficient space between food packages to allow a better cooling air circulation, hence to maintain better cooling effect.</p> 	<p>Allow clearance between food and inner walls Do not let food stick to the inner walls, or otherwise they may get frozen to the walls.</p> 

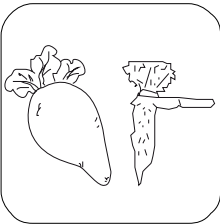
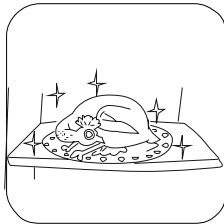
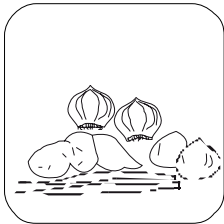
Tips & Hints for Using Refrigerator compartment

<p>Remove leaves of carrots and radishes before adding them to the refrigerator, thus to prevent leaves take nutrition from them.</p> 	<p>Thaw frozen food in the refrigerator compartment, this will help cooling food in the refrigerator compartment, and saves energy.</p> 	<p>For food which can obtain freshness under ambient temperature storage, such as onions, garlic, and other roots, you don't have to add them to the refrigerator.</p> 	<p>Fruits such as rice melon, Chinese quince, sweet melon, banana and pine apple can get ripe faster under lower temperatures, these fruits are not suitable for refrigeration fresh keeping unless you need them to get more ripe.</p> 
---	---	--	---

About the Freezer Drawer

Freezer drawer is designed for long-term fresh keeping

Temperature in the freezer drawer is very low, and is capable of keeping freshness of food for a long period of time. Add food which need to be stored for long time in the freezer drawer, but you should observe the expiration date printed on its packing.

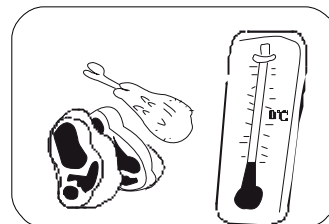

Lamp and its replacement

Lamp specifications: AC 115V, 40W;

Socket type: E17 (DO NOT use a bulb of over 40W);

Replacement:

- Unplug from wall outlet;
- Lift the lamp cover as shown in the figure, and pull it out.
- Screw counter clockwise to remove the bulb from socket. Replace new bulb of the same specifications.
- Replace lamp cover in a reverse sequence of removal procedures.

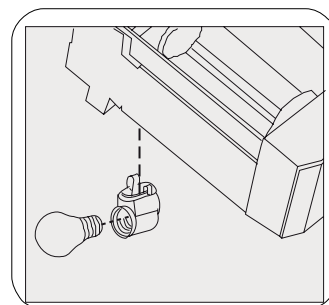





Ice storage bin

It is used to store ice cubes produced by the ice maker.

How to take ice cubes out

Pull out the storage bin to the most, take ice cubes out with a spoon, or rather take the whole storage bin out if needed.

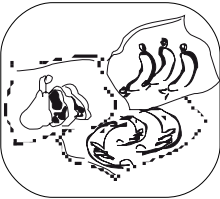
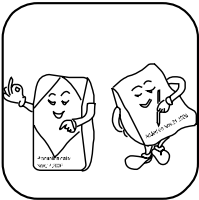
Precaution when Freezing Food

<p>Allow food to cool down to ambient temperature before adding to the refrigerator.</p>	<p>Divide food into smaller packages, this will make it easier to be frozen completely, and better after-thaw quality. For each package, 2.5kg at most is recommended.</p>	<p>Wrap food before adding to the refrigerator, and to prevent food packages from sticking into each other, make sure the wrapper surface is clean and dry. To prevent odor transfer and quality decline of food, pick materials free of odor, poison and stain, which can provide good air, water sealant at the same time as wrapper of food.</p>
		
<p>Take down the expiration date of food stored on the surface of its wrapper.</p>	<p>Generally, never add food which had been thawed from frozen status back into the freezer, unless they've been cooked. Otherwise the quality of food will not be good. So, take care to thaw only you'll cook at once each time.</p>	<p>Do not add too much food to the freezer at one time. Please refer to the freezing capacity listed in the 'Specification' section.</p>
		

Usage of Ice Maker, Cold Water Dispenser

Preparation

1.
 - Prepare the pipe in proper length, and make sure the piping line does not have too many turns. Usually, the piping should be shorter than 5 meters, or otherwise the pressure loss will reduce production capacity of ice cubes, and flow rate of water dispenser.
 - Piping line is not high temperature resistant, keep it away from heat sources.
 - Piping line should be installed by professionals.
 - At first start-up, you need to press down the cold water button many times (no more than one minute at one time) till the dispenser starts to provide cold water.
 - Instructions on piping work of water supply line
The ice maker requires a water supply pressure of 21-123 psi.
 - The water filter only provide filtration of foreign matters, it is not intended for anti-bacteria purpose, so, please make sure to connect to portable water supply.

Precautions:

2.
 - Do not install the water piping of ice maker in a position where the temperature may get under 32°F, as it may be frozen.
 - Flush water through the piping until water is clear. Check leakage around connectors.
 - The ice maker will produce ice cubes only after its temperature is no higher than 5°F (At first start-up, discard first several batches of ice made, to remove possible foreign matters remained within the water piping.).
 - When the refrigerator is installed, make sure to keep piping at proper places to avoid damage.
 - The water filter is designed to remove foreign matters from water supplied to the refrigerator. To guarantee clean ice production, it absorbs foreign matters from the water. After a certain period of usage, you may find out the ice cubes produced are getting less and smaller in size. This indicates that the water filter may be blocked. After half year's operation, the refrigerator will automatically turn on the water filter alert, please replace the water filter with a new one. Contact your local Haier after service center or the dealer from whom you purchased your refrigerator for information on water filter replacement. After the replacement is made, press the water alert reset key. During new installation, service personnel will be responsible for the installation of the water filter. After that, you need to carry out the replacement yourself.
 - Installation of ice maker should be carried out by certified organizations.
 - Your refrigerator requires connection to portable water supply only.

Operation of Ice Maker

Operation of ice maker:

3

The ice maker can produce 7 cubes at a time. Total daily quantity depends on ambient temperature, number of door openings, pressure of water supply and temperature within the freezer compartment.

Please arrange ice cubes in order, thus to make sure the storage bin can store more ice cubes.

The ice maker can produce 7 cubes at a time, it's normal if several cubes stick to each other.



NOTE

Allow 24 hours for the freezer compartment to cool down, and the ice maker to obtain best working conditions.

4

If this is your first ice maker:

You may hear special sounds made by the ice maker, this is very natural, you don't have to worry about it.

If you don't use ice very often:

5

'Old' ice cubes may get gray, and off-taste. Please discard old ice and clean the ice storage bin with warm water regularly. Before replacement of storage bin, make sure it is cooled down to ambient temperature, and put it to sunshine, or otherwise ice cubes may stick to other parts of the ice maker and reduce ice production.

6

Winter:

In winter season, if you should stop using the ice maker for a long time, please take out ice cubes from the storage bin, and wash the bin with warm water, then, replace it after wiping it clean. Shut off the water supply to the refrigerator.

Operation of Cold Water Dispenser

■ Using the cold water dispenser:

Press the cold water button with a cup as shown in the figure.

- There may be air entrapped in the piping, so you may have to hold down the button for a couple of minutes before you can get a cup of water.
- The first cup of water may be warmer than the next several cups, and there's a chance after the first 2 cups (about 8 ounces) of water, you may get warmer water again. This is normal.
- The cold water from the dispenser is neither ice nor mixture of water and ice. If you need colder water, please add ice cubes or smashed ice in your cup.

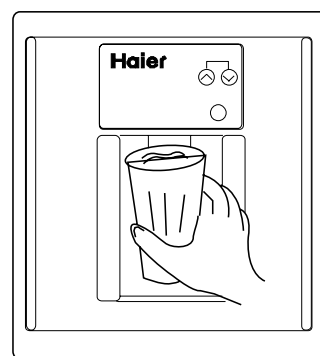

WARNING

Do not put your fingers and other objects into the cold water dispenser and the ice storage bin.

Precaution when Using Cold Water Dispenser

- Do not use glasses or paper cup that are too deep, too thin, too soft or whose walls are too thin.
- 5 seconds after you've finished with fetching water, a 'pap' sound will be heard, this is the sound produced by closing action of the outlet valve.
- After releasing the cold water button, please keep the cup under the water discharge opening for about 20 seconds, in case residue water spills.
- After disposal of water in the shelf, please wipe the spilled water on the lower end of dispenser.
- Never touch the water discharge opening or you might get injured.
- To flush out impurities in the water line, throw away first batch (about 7 glassfuls) of water dispensed.

Defrosting & Cleaning

Freezer defrosting:

The freezer incorporates automatic defrosting function, no manual interruption is needed.

Cleaning:

Food residue can build up odor inside the cabinet, regular cleaning is necessary to prevent this from happening.

- For your own safety, unplug the refrigerator before cleaning.
- Wipe the interior of the refrigerator by means of soft towel or sponge with warm water (mild detergent is applicable).
- Wipe off water on the exterior surface of the refrigerator.

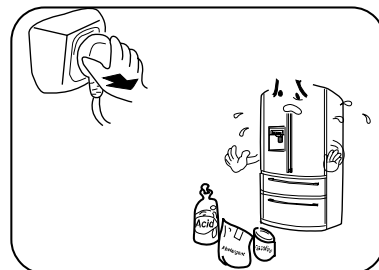

NOTE

1. Your refrigerator is heavy. When moving the refrigerator for cleaning and service, be sure to protect the floor. Always pull the refrigerator straight out when moving it. Do not wiggle or 'walk' the refrigerator when trying to move it, as floor damage could occur.
2. Do not spray or pour water to the refrigerator for cleaning, this may reduce electrical insulation performance.
3. Use dry towel for electrical parts such as switches and the lamp.
4. Do not use stiff or wire brush for cleaning, or an organic solvent such as harsh detergent, gasoline, lacquer thinner, acetone as detergent, or hot water, acid, alkali.
5. Do not touch frozen metal surfaces with wet hands, you might get frostbite.
6. Do not wash cold glass shelves with hot water, quick change in temperature may crash the glass parts, or even loss of other property or person injury.
7. Check and clean the gaskets regularly.
8. Do not use lacquer thinner as odor absorber, as fire hazard may occur.

■ Water filter indicator lights up

This is a signal showing that you might need to replace your old water filter. It is recommended that after 6 month's operation, or when the ice production declines greatly, new water filter shall be installed. Please observe actual usage conditions, and the local portable water quality, you may need new water filters more often than above mentioned.

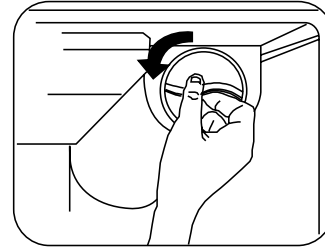

Water filter replacement:

1. Turn the water filter counter clockwise;
2. The water filter will pop open;
3. Take out the water filter from the holder.

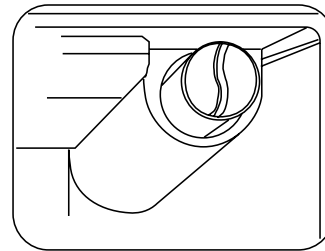

NOTE

The used water filter may hold water, and this residue water may overflow through the hole of the water filter holder.

Water Filter

4. Remove the protection film from the new water filter, then insert the new filter into the holder with the handle in a vertical position.
5. Turn the filter clockwise, until it won't move any more. The handle should be in a horizontal position.
6. When the replacement is done, flush the water line for 5 minutes to get rid of impurities. Throw away flush water.
7. At last, don't forget to reset the water filter alert display.

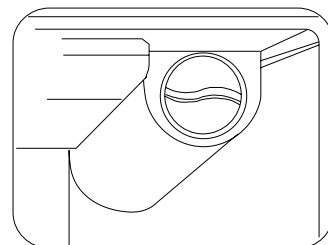
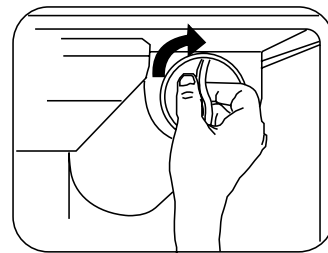
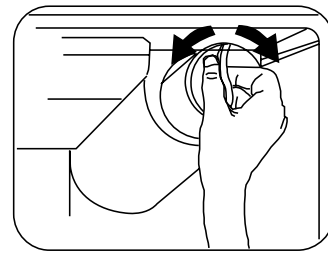
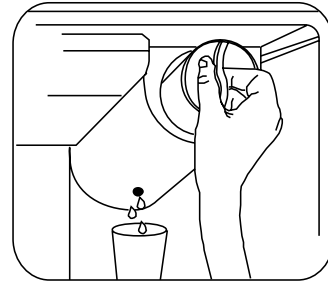

NOTE

1. Without the water filter, the cold water dispenser and the ice maker won't work.
2. Please consult your local dealer or call 1-877-337-3639 for water filter replacement information or other information concerning Haier appliances.



NOTE

1. Do not use with water that is microbiologically unsafe or of unknown quality without adequate disinfection before or after the system. Systems certified for cyst reduction may be used on disinfected waters that may contain filterable cysts.
2. After installation of new water filter, discard all ice produced during the first 24 hours.
3. If water dispenser or ice maker has not been actively used for an extensive time, or if ice cubes have an unpleasant taste or odor, change water filter.
4. Air entrapped in the water line may cause water and filter to eject, be aware of this possibility when r

Stopping

Handling power failure

Food can be stored well after several hours of power failure even if it is in summer. You should inquire how long it will last by calling your electric company.

- After power fail, do not add food to the refrigerator, open door as little as possible.
- If failure of more than 24 hours is noticed beforehand, make some extra ice cubes and hold them in a waterproof container. Place the container to the top shelf of the refrigerator compartment.

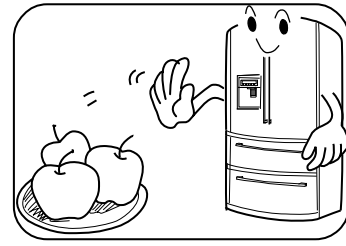

NOTE

Temperature raise in the freezer because of power failure or other malfunction may shorten the valid date and decrease food quality.

Stopping usage:

If you need to stop the refrigerator for a long time, pull out the plug, cut off power and water supply, clean the refrigerator as per previous descriptions, then, leave all doors and drawers open to prevent odor from building up inside.

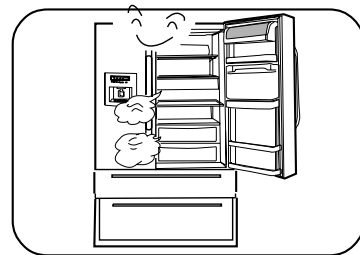

NOTE

Vacation:

If on vacation for a long time, unplug the refrigerator and take out food. Clean the interior after frost melts, open all doors and drawers and wipe the refrigerator dry to prevent odor that may be produced by food residue. If the ambient temperature is below freezing point, have a qualified service personnel drain the water line to prevent leakage due to burst of piping or joints, which may cause serious property loss.



Transportation:

- Unplug the refrigerator from wall outlet.
- Take out all food.
- Fix all moveable parts in the refrigerator such as shelves, crisper etc. with tape.
- Close the refrigerator doors and fix it with tape to prevent opening during transportation.
- During transportation, the maximum slant angle must not exceed 45 degrees (the angle with vertical direction) to prevent cooling system faults.
- Do not hold the handles of the refrigerator during transportation, as property loss or personal injury may occur.

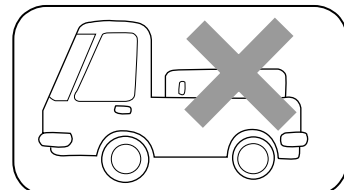
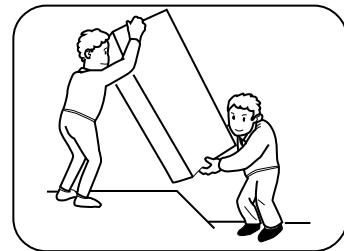

WARNING

The refrigerator must never be put flat at any time.

Troubleshooting

Before calling for service, please read through the information listed below, this may save you time and energy. Most common problems are listed hereunder, not including defects of workmanship and materials used in the production of this refrigerator.

Problem observed	Possible cause	Solution
Running of refrigerator		
Compressor does not work.	<ul style="list-style-type: none"> ■ Refrigerator is in defrost cycle. 	<ul style="list-style-type: none"> ■ This is normal for a fully automatic defrost refrigerator. The defrost cycle occurs regularly, lasting around 30 minutes each time.
	<ul style="list-style-type: none"> ■ Not connected to wall outlet. 	<ul style="list-style-type: none"> ■ Make sure the plug is securely connected to a wall outlet.
	<ul style="list-style-type: none"> ■ House fuse blown or circuit breaker tripped. 	<ul style="list-style-type: none"> ■ Replace a 20amp time-delay fuse, or reset the circuit breaker.
	<ul style="list-style-type: none"> ■ Power outage. 	<ul style="list-style-type: none"> ■ Check outlets for power supply, or call local electric company.
Refrigerator runs too much	<ul style="list-style-type: none"> ■ High ambient temperature. 	<ul style="list-style-type: none"> ■ It normal for the refrigerator to work longer under this condition.
	<ul style="list-style-type: none"> ■ Refrigerator has been out of power for some time. 	<ul style="list-style-type: none"> ■ Allow 8-12 hours for the refrigerator to cool down.
	<ul style="list-style-type: none"> ■ Ice maker in operation. 	<ul style="list-style-type: none"> ■ Usage of ice make can prolong refrigerator's running time a little bit.
	<ul style="list-style-type: none"> ■ Frequent door or long openings. 	<ul style="list-style-type: none"> ■ Warm air enters the refrigerator and increase running time required. Keep down door openings.
	<ul style="list-style-type: none"> ■ Door(s) not securely closed. 	<ul style="list-style-type: none"> ■ Make sure the installation is level. Keep food, shelves and drawers from blocking the door.
	<ul style="list-style-type: none"> ■ Freezer temperature is set too low 	<ul style="list-style-type: none"> ■ Set freezer to a higher temperature until satisfactory. It takes 24 hours for the new settings to take effect stably.
	<ul style="list-style-type: none"> ■ Gasket(s) is dirty, worn, cracked, or poorly fitted. 	<ul style="list-style-type: none"> ■ Clean or replace with new gasket. Poor air tight performance will cause overrun of the refrigerator.
	<ul style="list-style-type: none"> ■ Dirty condenser. 	<ul style="list-style-type: none"> ■ Clean the condenser.
Compressor cycles on and off frequently.	<ul style="list-style-type: none"> ■ Thermostat keeps the refrigerator at a constant temperature. 	<ul style="list-style-type: none"> ■ This is normal. The compressor cycles to maintain even temperature.
Temperature too low		
Freezer too cold, refrigerator ok	<ul style="list-style-type: none"> ■ Freezer control is set too cold. 	<ul style="list-style-type: none"> ■ Change freezer settings, allow 24 hours for temperature to stabilize.
Refrigerator too cold, freezer ok	<ul style="list-style-type: none"> ■ Refrigerator control is set too cold. 	<ul style="list-style-type: none"> ■ Change refrigerator settings, allow 24 hours for temperature to stabilize

Troubleshooting

Problem observed	Possible cause	Solution
Temperature too low		
Food in drawer is frozen.	<ul style="list-style-type: none"> Control is set too cold. 	<ul style="list-style-type: none"> Change settings, allow 24 hours for temperature to stabilize
Food in meat drawer(for some model) is frozen	<ul style="list-style-type: none"> Control is set too cold. 	<ul style="list-style-type: none"> Change settings. (fresh meat should be stored at a temperature just below freezing point for maximum fresh storage time. It is normal for ice crystals to form due to the moisture content of meat.)
Digital temperature display blinks	<ul style="list-style-type: none"> Electronic control system has detected an operation problem. 	<ul style="list-style-type: none"> Call your Haier service personnel for information concerning the error code displayed.
Temperature too high		
Temperature too high in freezer and refrigerator	<ul style="list-style-type: none"> Too much door openings. 	<ul style="list-style-type: none"> Keep down door openings.
	<ul style="list-style-type: none"> Door(s) not securely closed. 	<ul style="list-style-type: none"> Please refer to 'Door/Drawer' section for details.
	<ul style="list-style-type: none"> Dirty condenser. 	<ul style="list-style-type: none"> Clean the condenser.
Freezer too warm, refrigerator ok	<ul style="list-style-type: none"> Freezer temperature is set too warm. 	<ul style="list-style-type: none"> Change freezer settings, allow 24 hours for temperature to stabilize.
Refrigerator too warm, freezer ok	<ul style="list-style-type: none"> Refrigerator temperature is set too warm. 	<ul style="list-style-type: none"> Change refrigerator settings, allow 24 hours for temperature to stabilize
Meat drawer too warm	<ul style="list-style-type: none"> Meat drawer temperature is set too warm. 	<ul style="list-style-type: none"> Change meat drawer settings to lower temperature.
Water/moisture/frost building up from inside		
Moisture building up inside	<ul style="list-style-type: none"> Hot and humid weather 	<ul style="list-style-type: none"> This is normal, moisture and water drops tends to build up faster in such weather.
	<ul style="list-style-type: none"> Door(s) not securely closed. 	<ul style="list-style-type: none"> Please refer to 'Door/Drawer' section for details.
	<ul style="list-style-type: none"> Too much door openings. 	<ul style="list-style-type: none"> Keep down door openings.
	<ul style="list-style-type: none"> Open containers inside refrigerator 	<ul style="list-style-type: none"> Cap the containers.
Water collects on bottom of drawer covers	<ul style="list-style-type: none"> Vegetables give off moisture 	<ul style="list-style-type: none"> This is normal.
		<ul style="list-style-type: none"> Change to a lower 'remove humidity control' (for some models)
Water collects on bottom of drawers	<ul style="list-style-type: none"> Water drained from fruits and vegetables which were washed before added to the refrigerator 	<ul style="list-style-type: none"> This is normal. Wipe off water before adding food to the refrigerator.
Water/moisture/frost building up on exterior surfaces		
Water/moisture/frost building up on exterior surfaces or between doors.	<ul style="list-style-type: none"> Humid weather 	<ul style="list-style-type: none"> This is normal, and should not be a problem any more when weather is less humid.
	<ul style="list-style-type: none"> Door(s) not securely closed, cold air from inside turns to build up moisture/frost/water when contact with warm air outside. 	<ul style="list-style-type: none"> Please refer to 'Door/Drawer' section for details.

Troubleshooting

Problem observed	Possible cause	Solution
Automatic ice maker		
Ice maker does not work.	■ Ice level sensing lever is in upper or 'OFF' position.	■ Put down the lever, or reset it to 'ON' position.
	■ Water line shut off, or freezer not cold enough.	■ Turn on the water supply, or refer to 'Temperature too warm' section.
	■ The shutoff valve blocked, or restricted by other objects.	■ Shut off valve and move it to a proper position.
	■ Check if water dispenser works.	■ Make sure that the valve incorporated is not a self piercing saddle valve. Clean the valve, and replace it if necessary. Or, check whether the water filter is blocked and change it when necessary.
Ice cubes produced is not sufficient	■ Not enough to your satisfactory	■ Ice maker can produce 4-5 pounds of ice each 24 hours, or 6 pounds at most.
	■ Freezer not cold enough	■ Please refer to 'Temperature too warm' section.
	■ Water supply valve not fully open.	■ Turn off the water supply valve.
	■ Check if the water dispenser is delivering less water.	■ Check if it's necessary to replace the filter.
Ice maker never stops	■ Ice level sensing lever is stuck in lower position.	■ Release the lever, and remove ice formed on the lever if necessary.
Ice produced is off-taste	■ Odor transferred from refrigerator or freezer	■ Wrap food before adding to the refrigerator. Discard old ice cubes. Use newly produced ice.
	■ Portable water not qualified	■ Incorporate extra filter to the water supply line, consult and water filter provider.
	■ Ices cubes have been stored too long	■ Discard old ice cubes.
Water dispenser problems		
Does not deliver water	■ No water supply.	■ Turn on the water supply. Please also refer to 'Ice maker does not work' section.
	■ Water filter blocked.	■ Replace water filter.
	■ Upstream filter (If exists) is not well installed.	■ Push the filter into its holder until a click sound is heard. The handle of the filter should be in horizontal position.
Water is off-taste.	■ Water has been stored for a long time.	■ Throw away 10-12 glassful of water to refresh and flush the water line.
	■ Improper water supply connection	■ Connect to kitchen water supply.
	■ Tubing and installation may affect water taste.	■ Better use copper tubing.
	■ High mineral contents within water supply.	■ Consult water plant for help.

Troubleshooting

Problem observed	Possible cause	Solution
Water dispenser problems		
Low water pressure	<ul style="list-style-type: none"> ■ Cut-off and cut-on pressure too low (for well system only) 	<ul style="list-style-type: none"> ■ Have someone turn up the cut-off/cut-on pressure on the water pump system.
	<ul style="list-style-type: none"> ■ reverse osmosis system in regenerative phase 	<ul style="list-style-type: none"> ■ It normal to have pressure under 30psi when reverse osmosis system is in regenerative phase.
Odor building up		
Dirty inside the refrigerator	<ul style="list-style-type: none"> ■ The refrigerator needs clean. 	<ul style="list-style-type: none"> ■ Clean the refrigerator.
	<ul style="list-style-type: none"> ■ There's food with strong odor. 	<ul style="list-style-type: none"> ■ Wrap food before adding to the refrigerator.
Open/Close doors and drawers		
Door(s) not closing properly	<ul style="list-style-type: none"> ■ Door(s) slightly open upon the shock due to heavy operation of other doors 	<ul style="list-style-type: none"> ■ Close door gently.
	<ul style="list-style-type: none"> ■ Refrigerator is not level. It rocks on the floor when moved slightly. 	<ul style="list-style-type: none"> ■ Make sure floor is level and solid to provide adequate support for the refrigerator. Please refer 'Location' section.
	<ul style="list-style-type: none"> ■ Refrigerator door(s) is installed in contact with wall or cabinet. 	<ul style="list-style-type: none"> ■ Make sure floor is level and solid to provide adequate support for the refrigerator. Please refer 'Location' section. Have a qualified technician adjust the sloping or inclining.
Light(s) does not work		
Light(s) does not work	<ul style="list-style-type: none"> ■ Bulb burnt. 	<ul style="list-style-type: none"> ■ Please refer to related contents on usage of refrigerator compartment, freezer compartment and drawers.
	<ul style="list-style-type: none"> ■ Light switch stuck. 	<ul style="list-style-type: none"> ■ Find the switch on the side of correspondent compartments and release it.
	<ul style="list-style-type: none"> ■ Refrigerator not energized. 	<ul style="list-style-type: none"> ■ Please refer to 'Running of refrigerator' section.
Sound		
Beeps	<ul style="list-style-type: none"> ■ Some door(s) is left open. 	<ul style="list-style-type: none"> ■ This is normal sound of door alarm. It will come up every minute until all doors are properly closed.

Limited Warranty

Coverage and length of warranty:

This warranty covers all defects in workmanship or materials for: labor (12 months); parts (12 months); sealed systems (5 years), and is valid since the date of purchase, upon presentation of the original purchase receipt.

Exceptions: Commercial or rental usage

Labor (90 days, carry in only); parts (90 days) only.

What is covered:

1. The mechanical and electrical parts, which serve as a functional purpose of this appliance, is warranted for 12 months. This include all parts except finishing and trim.
2. Components of the sealed systems, e.g. hermetic compressor, condenser and evaporator from manufacturing defects for a period of 5 years from the date of purchase. Any damages to such components caused by mechanical abuse or improper handling or shipping will not be covered.
- 3.

What will be done:

1. We will repair or replace, at our discretion any mechanical or electrical part which proves to be defective in normal usage during the warranty period.
2. There will be no charge to the purchaser for parts and labor on any covered items during the initial 12 month period. Beyond this period, only parts are covered in the remaining warranty. Labor is not provided and must be paid by the customer.
3. Contact your nearest authorized services center. For the name of the nearest service, center please call 1-877-337-3639.

This warranty covers appliances within the continental United States, Puerto Rico and Canada. It does not cover the followings:

- Damages from improper installation.
- Damages in shipping.
- Defects other than manufacturing workmanship.
- Damage from misuse, abuse, accident, alteration, lack of proper care and maintenance or incorrect current or voltage.
- Damage from other than single household use.
- Damage from services by other than an authorized dealer or service center.
- Decorative trims or replaceable light bulbs.
- Transportation and shipping.
- Labor (after the initial 12 months).

This limited warranty is given in lieu of all other warranties, expressed or including the warranties of merchantability and fitness for a particular purpose.

The remedy provided in this warranty is exclusive and is granted in lieu of all other remedies.

This warranty does not cover incidental or consequential damages, so the above limitations may not apply to you. Some states do not allow limitations on how long an implied warranty lasts, so the above limitations may not apply to you.

This warranty gives you specific legal rights, and you may have other rights, which vary, from state to state.