

This Owner's Manual is provided and hosted by [Appliance Factory Parts](#).

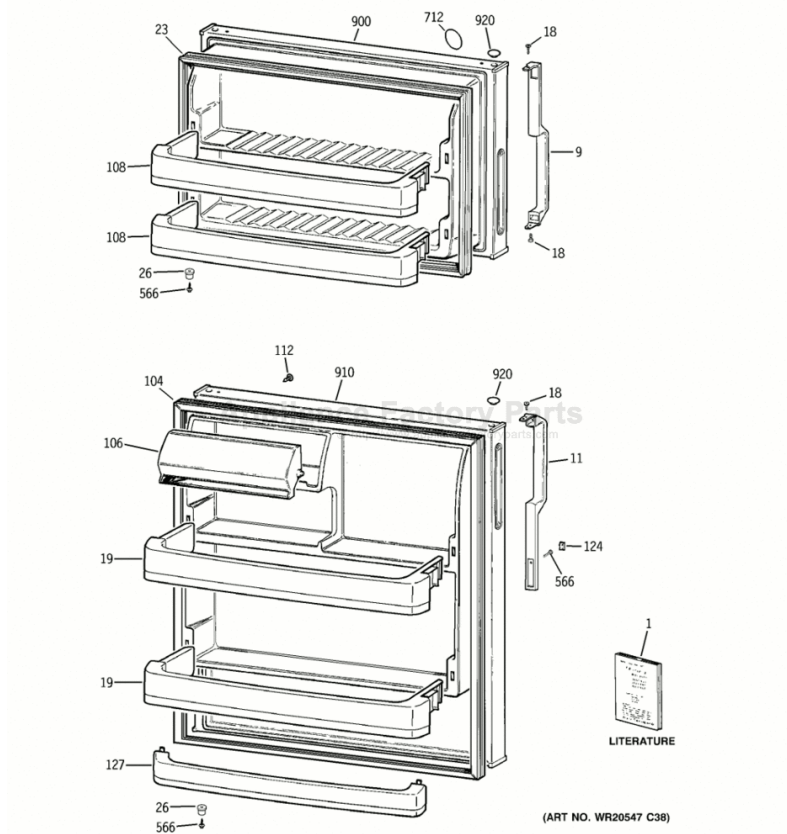

GE GTH18GCDRCRCC Owner's Manual

[Shop genuine replacement parts for GE
GTH18GCDRCRCC](#)



[Find Your GE Refrigerator Parts - Select From 27438 Models](#)

----- Manual continues below part list -----

Available Replacement Parts for GE GTH18GCDCRCC

40A15	BULB APPLIANCE
WR17X11890	SHELF FIXED FZ
WR51X10038	HEATER CONDUCTION AFTERMARKET
WR09X20002	CONTROL TEMP AFTERMARKET
WR02X10098	REFRIGERATOR GROMMET
WR60X10204	BLADE EVAP FAN ASM.
WR02X12008	GROMMET EVAP FAN
WR02X20092	DUCT FOAM
WR17X12852	HOUSING CONTROL
WR17X11662	COVER VEG PAN
WR30X10093	ELECTRONIC icemaker DOMESTIC
WR24X10228	GASKET DOOR FZ AFTERMARKET
WR17X11889	SHELF FIXED FF
WR60X23584	MOTOR AC/DC AFTERMARKET
WR02X13355	KNOB CONTROL
WR24X10236	GASKET
WR30X10154	BUCKET ICE
WR55X24064	REFRIGERATOR CAPACITOR



Top-Freezer Refrigerators

Safety Instructions 2-4

Operating Instructions

Automatic Icemaker 7
Care and Cleaning 8
Shelves 5, 6
Storage Drawers 6
Temperature Controls 5

Installation Instructions

Preparing to Install
the Refrigerator 9
Reversing the Door Swing 13-16
Water Line Installation 10-12

Troubleshooting Tips

Before You Call For Service 17, 18
Normal Operating Sounds 17

Consumer Support

Consumer Support Back Cover
Refrigerator Warranty 19

**Owner's Manual and
Installation Instructions**

Models 16, 17, 18

**Write the model and serial
numbers here:**

Model # _____

Serial # _____

You can find them on a label on
the upper left side of the fresh food
compartment.

IMPORTANT SAFETY INFORMATION. READ ALL INSTRUCTIONS BEFORE USING.

⚠ DANGER! RISK OF CHILD ENTRAPMENT PROPER DISPOSAL OF THE REFRIGERATOR

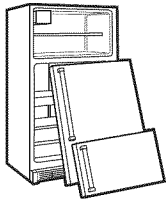

Child entrapment and suffocation are not problems of the past. Junked or abandoned refrigerators are still dangerous...even if they will sit for "just a few days." If you are getting rid of your old refrigerator, please follow the instructions below to help prevent accidents.

Before You Throw Away Your Old Refrigerator or Freezer:

- Take off the doors.
- Leave the shelves in place so that children may not easily climb inside.
- If the refrigerator has a lock make it unusable

Refrigerants

All refrigeration products contain refrigerants, which under federal law must be removed prior to product disposal. If you are getting rid of an old refrigeration product, check with the company handling the disposal about what to do.

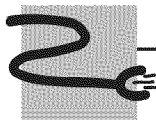

USE OF EXTENSION CORDS

Because of potential safety hazards under certain conditions, we strongly recommend against the use of an extension cord.

However, if you must use an extension cord, it is absolutely necessary that it be a UL-listed (in the United States) or a CSA certified (in Canada), 3-wire grounding type appliance extension cord having a grounding type plug and outlet and that the electrical rating of the cord be 15 amperes (minimum) and 120 volts.

⚠ DANGER! RISQUES POUR LES ENFANTS COMMENT VOUS DÉBARRASSER CONVENABLEMENT DE VOTRE ANCIEN RÉFRIGÉRATEUR

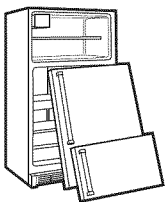

Les enfants pris au piège ou morts d'asphyxie sont toujours d'actualité. Les réfrigérateurs abandonnés sont toujours aussi dangereux, même si on n'attend que «quelques jours» pour s'en débarrasser. Si vous ne gardez pas votre ancien réfrigérateur, veuillez suivre les directives ci-dessous afin de prévenir les accidents.

Avant de vous débarrasser de votre ancien réfrigérateur ou congélateur :

- Démontez les portes.
- Laissez les clayettes en place afin d'empêcher les enfants de grimper à l'intérieur.

Réfrigérants

Tous les appareils de réfrigération contiennent des réfrigérants qui, conformément aux lois fédérales, doivent être enlevés avant toute élimination de l'appareil. Si vous vous débarrassez de vieux appareils de réfrigération, vérifiez, auprès de la société qui s'occupe de leur élimination, ce que vous devez faire.

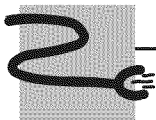

CORDONS PROLONGATEURS

Nous vous recommandons fortement de ne pas utiliser de cordons prolongateurs à cause des risques potentiels qu'ils présentent dans certaines conditions.

Toutefois si vous décidez d'utiliser tout de même un cordon prolongateur, il est absolument nécessaire qu'il s'agisse d'un cordon à 3 fils avec mise à la terre pour appareils électroménagers homologué UL (aux États-Unis) ou certifié CSA (au Canada), pourvu d'une fiche et d'une prise mises à la terre de 15 ampères (minimum) et de 120 volts.

IMPORTANT SAFETY INFORMATION. READ ALL INSTRUCTIONS BEFORE USING.

GEAppliances.com

⚠ WARNING!

Use this appliance only for its intended purpose as described in this Owner's Manual.



SAFETY PRECAUTIONS

When using electrical appliances, basic safety precautions should be followed, including the following:

- This refrigerator must be properly installed and located in accordance with the Installation Instructions before it is used.
- Do not attempt to or allow children to climb, stand or hang on the shelves in the refrigerator. They could damage the refrigerator and seriously injure themselves.
- Do not touch the cold surfaces in the freezer compartment when hands are damp or wet. Skin may stick to these extremely cold surfaces.
- Do not store or use gasoline or other flammable vapors and liquids in the vicinity of this or any other appliance.
- Keep fingers out of the "pinch point" areas; clearances between the doors and between the doors and cabinet are necessarily small. Be careful closing doors when children are in the area.
- Unplug the refrigerator before cleaning and making repairs.
- In refrigerators with automatic icemakers, avoid contact with the moving parts of the ejector mechanism, or with the heating element that releases the cubes. Do not place fingers or hands on the automatic icemaking mechanism while the refrigerator is plugged in.

NOTE: We strongly recommend that any servicing be performed by a qualified individual.
- Turning the temperature control to the **OFF** position does not remove power to the light circuit.
- Do not refreeze frozen foods which have thawed completely.
- Do not allow children to play with refrigerator or tamper with controls.
- **Before replacing a burned-out light bulb, the refrigerator should be unplugged** in order to avoid contact with a live wire filament. (A burned-out light may break when being replaced.)

MESURES DE SÉCURITÉ IMPORTANTES. LISEZ D'ABORD TOUTES LES DIRECTIVES.

⚠ AVERTISSEMENT!

N'utilisez cet électroménager que pour l'usage auquel il est destiné, comme expliqué dans le présent manuel.



MESURES DE SÉCURITÉ

Lorsque vous utilisez un appareil électrique, observez toujours les mesures de sécurité de base, y compris les suivantes.

- Installez le réfrigérateur conformément aux directives d'installation avant de l'utiliser.
- Ne laissez pas les enfants grimper, s'asseoir, se tenir debout ni se pendre aux clayettes du réfrigérateur. Ils pourraient endommager le réfrigérateur et se blesser gravement.
- N'entreposez et n'utilisez pas d'essence ou autres vapeurs et liquides inflammables à proximité de cet appareil ou de tout autre appareil électroménager.
- Éloignez les doigts des parties du réfrigérateur où l'on peut facilement se pincer : les espaces entre les portes et entre les portes et les placards sont toujours étroits. Soyez prudent lorsque vous fermez les portes de l'appareil en présence des enfants.
- Débranchez votre réfrigérateur avant de le nettoyer ou de le réparer.
- Si votre réfrigérateur est doté d'une machine à glaçons automatique évitez le contact avec les pièces mobiles du mécanisme éjecteur, ou avec l'élément chauffant qui libère les glaçons.
Ne posez pas les doigts ou les mains sur le mécanisme de la machine à glaçons pendant que le réfrigérateur est branché.
- Ne touchez pas les surfaces froides du congélateur si vous avez les mains humides ou mouillées : la peau risque d'adhérer à ces surfaces très froides.

REMARQUE : Nous vous recommandons vivement de confier toute réparation à un technicien qualifié.
- Lorsque vous réglez la commande sur 0 (éteint), l'alimentation électrique de l'ampoule n'est pas coupée.
- Ne recongelez pas les aliments surgelés qui ont complètement dégelé.
- Le réfrigérateur doit être débranché avant de remplacer l'ampoule afin d'éviter tout contact avec un fil de câble sous tension.

IMPORTANT SAFETY INFORMATION. READ ALL INSTRUCTIONS BEFORE USING.

⚠ WARNING!

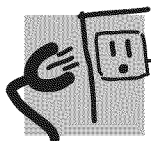

HOW TO CONNECT ELECTRICITY

Do not, under any circumstances, cut or remove the third (ground) prong from the power cord. For personal safety, this appliance must be properly grounded.

The power cord of this appliance is equipped with a 3-prong (grounding) plug which mates with a standard 3-prong (grounding) wall outlet to minimize the possibility of electric shock hazard from this appliance.

Have the wall outlet and circuit checked by a qualified electrician to make sure the outlet is properly grounded.

Where a standard 2-prong wall outlet is encountered, it is your personal responsibility and obligation to have it replaced with a properly grounded 3-prong wall outlet.

The refrigerator should always be plugged into its own individual electrical outlet which has a voltage, wattage and frequency that match the rating plate.

This provides the best performance and also prevents overloading house wiring circuits which could cause a fire hazard from overheated wires.

Never unplug your refrigerator by pulling on the power cord. Always grip plug firmly and pull straight out from the outlet.

Repair or replace immediately all power cords that have become frayed or otherwise damaged. Do not use a cord that shows cracks or abrasion damage along its length or at either end.

When moving the refrigerator away from the wall, be careful not to roll over or damage the power cord.



READ AND FOLLOW THIS SAFETY INFORMATION CAREFULLY.

SAVE THESE INSTRUCTIONS

MESURES DE SÉCURITÉ IMPORTANTES. LISEZ D'ABORD TOUTES LES DIRECTIVES.

⚠ AVERTISSEMENT!

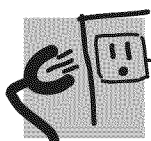

RACCORDEMENT ÉLECTRIQUE

Ne coupez ni retirez en aucun cas la troisième broche (mise à la terre) de la fiche du cordon d'alimentation. Pour votre sécurité, cet appareil doit être correctement mis à la terre.

Le cordon d'alimentation de cet appareil est muni d'une fiche à 3 broches (mise à la terre) qui se branche dans une prise murale ordinaire à 3 alvéoles (mise à la terre) pour réduire au minimum les risques de chocs électriques.

Faites examiner la prise de courant et le circuit par un électricien qualifié pour vous assurer que la prise est correctement mise à la terre.

Si la prise murale est du type standard à 2 alvéoles, il vous incombe de la faire remplacer par une prise à 3 alvéoles correctement mise à la terre.

Le réfrigérateur doit toujours être branché dans sa propre prise de courant, dont la tension nominale est identique à celle indiquée sur la plaque signalétique.

Cette précaution est recommandée pour garantir un rendement optimum et éviter une surcharge des circuits électriques de la résidence, ce qui pourrait créer un risque d'incendie par surchauffe des fils.

Ne débranchez jamais le réfrigérateur en tirant sur le cordon d'alimentation. Saisissez fermement la fiche du cordon et tirez droit pour la retirer de la prise.

Réparez ou remplacez immédiatement tout cordon effiloché ou endommagé. N'utilisez pas un cordon fendillé ou présentant des signes d'usure.

Lorsque vous déplacez votre réfrigérateur du mur, faites attention de ne pas le faire rouler sur le cordon d'alimentation afin de ne pas l'endommager.



VEUILLEZ LIRE ET SUIVRE ATTENTIVEMENT CES MESURES DE SÉCURITÉ. CONSERVEZ CES DIRECTIVES

About the temperature control dial.

Turning the dial to **0/ Off** stops cooling in both compartments—fresh food and freezer. It does not shut off power to the refrigerator.

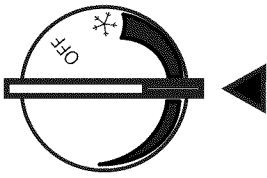

Temperature Control Dial (on some models)

The temperature control dial adjust refrigerator from warmest to coldest. The recommended factory setting is shown in illustration to the left. For colder temperature turn dial clockwise toward snowflake. For warmer temperature turn dial counter clockwise away from snowflake. allow 24 hours for adjustment.

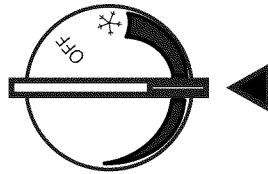

Recommended factory setting

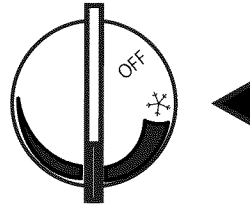

Coldest setting

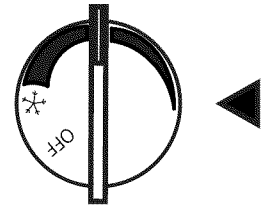

Warmest setting

About the fresh food compartment shelves.

Shelf supports at various levels allow you to custom-space your shelves. Not all features are on all models.

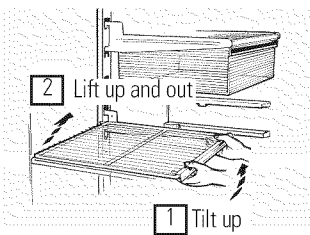

Half-Width Shelves

One end of the shelf rests on a molded side-wall support; a bracket on the other end hooks into a track on the rear cabinet wall. To remove, lift the shelf up at front, then off the support and out of the track. To replace, select desired shelf height. With shelf front raised slightly, hook the bracket's top lug into the track, then lower the shelf onto the support.

NOTE: The shelf to the right of the track is designed to hook into the right-hand slot; the shelf to the left is designed to hook into the left-hand slot.

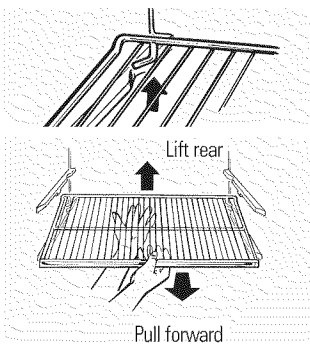
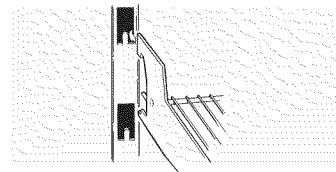

To remove the full-width shelves

Full-Width Shelves

Some models have a stationary tempered glass shelf, a spillproof shelf, or two steel wire stationary shelves. These shelves can be moved to another place in the fresh food compartment.

When placed correctly on the shelf supports, the shelf will stop before coming completely out of the refrigerator and will not tilt when you place food on it or remove food from it.

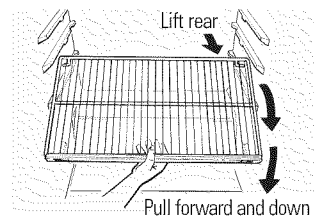

To remove a full-width shelf when the fresh food compartment door cannot be opened fully

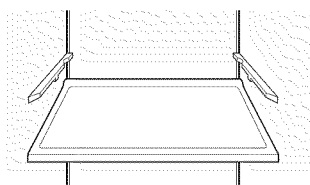

Spillproof Shelves (on some models)

Spillproof shelves have special edges to help prevent spills from dripping to lower shelves. To remove or replace the shelves, see the above instructions.

About the freezer compartment shelves.

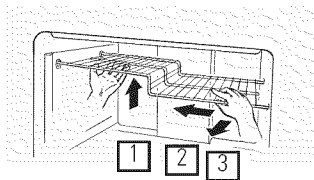

Step Shelf (on some models)

To remove the step shelf:

- 1 Lift left side of shelf slightly.
- 2 Move shelf to the left to free its right ends from holes in the cabinet wall.
- 3 Lower right side of shelf, move shelf to the right and take it out.

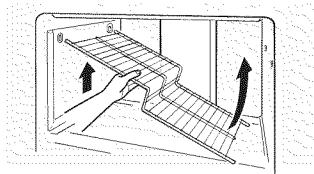

To replace the step shelf:

- 1 With shelf tilted as shown, fit left ends of shelf into holes in cabinet wall.
- 2 Lift left side of shelf slightly, swing shelf up, fit right ends of shelf into holes in cabinet wall, and lower shelf into place.

About the storage drawers.

Not all features are on all models.

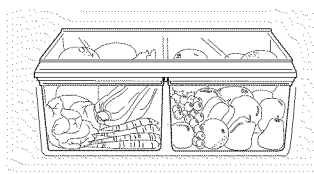

Fruit and Vegetable Drawers

Excess water that may accumulate in the bottom of the drawers should be emptied and the drawers wiped dry.

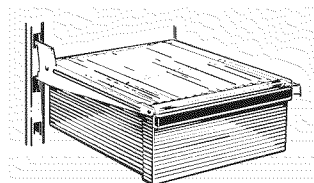

Snacks Drawer

The snacks drawer can be moved to the most useful location for your family's needs.

About storage drawer and cover removal.

Not all features are on all models.

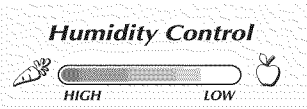

Adjustable Humidity Drawer (on some models)

Slide the control all the way to the HIGH setting to provide high humidity recommended for most vegetables.

Slide the control all the way to the LOW setting to provide lower humidity levels recommended for most fruits.

Drawer and Cover Removal

Drawers can be removed easily by grasping the sides and lifting up slightly while pulling drawers past the stop location.

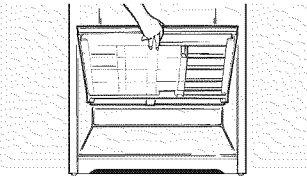

Full-Width Drawer with Plastic Cover

To remove the cover, lift it off its supports, pull it forward, tilt it and take it out.

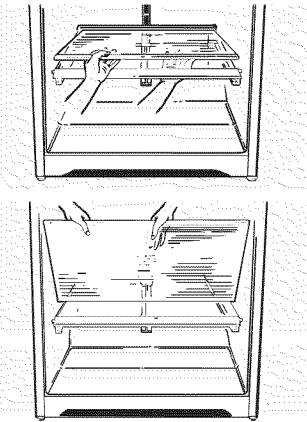

Twin Drawer Shelf

To remove:

- 1 Remove the drawers.
 - 2 Reach in, push the front of glass cover up, and at the same time, pull it forward as far as it will come.
- Tilt it and take it out. Avoid cleaning the cold glass cover with hot water because the extreme temperature difference may cause it to break.
- 3 Remove the drawer frame. (Always remove the glass cover before you take out the drawer frame.)

To replace:

- 1 Lower the frame until it rests on the supports at each side and back.
- 2 Replace the glass cover, pushing its rear edge firmly into the rear frame channel and gently lowering the front into place.
- 3 Replace the drawers.

Lift the frame off the supports at each side and back, pull it forward, tilt it and take it out.

About the automatic icemaker.

A newly-installed refrigerator may take 12 to 24 hours to begin making ice.

There are 2 types of icemakers:

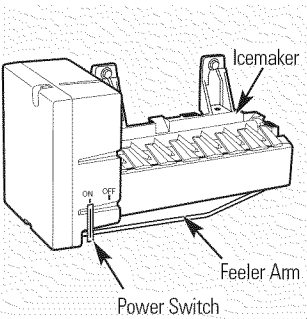

Power switch model

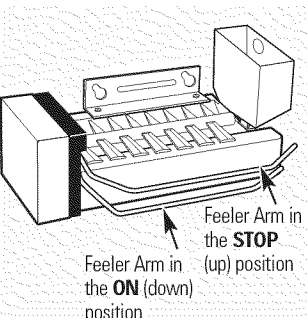

Feeler arm model

Automatic Icemaker (on some models)

The icemaker will produce approximately 70-100 cubes in a 24-hour period, depending on the freezer compartment temperature, room temperature, number of door openings and other use conditions.

If the refrigerator is operated before the water connection is made to the icemaker, set the switch to OFF or move the feeler arm to the STOP (up) position.

When the refrigerator has been connected to the water supply, set the switch to the ON position or move the feeler arm to the ON (down) position.

The icemaker will fill with water when it cools to 15°F. A newly-installed refrigerator may take 12 to 24 hours to begin making ice cubes.

Once the icemaker starts to make ice, it may take up to 48 hours to fill the bin, depending on the temperature settings and number of door openings.

You will hear a buzzing sound each time the icemaker fills with water.

Throw away the first few batches of ice to allow the water line to clear.

Be sure nothing interferes with the sweep of the feeler arm.

When the bin fills to the level of the feeler arm, the icemaker will stop producing ice.

It is normal for several cubes to be joined together.

If ice is not used frequently, old ice cubes will become cloudy, taste stale, shrink or fuse together.

Icemaker Accessory Kit

If your refrigerator did not already come equipped with an automatic icemaker, an icemaker accessory kit is available at extra cost.

Check the back of the refrigerator for the specific icemaker kit needed for your model.

Care and cleaning of the refrigerator.

Cleaning the Outside

The door handles and trim (on some models). Clean with a cloth dampened with soapy water. Dry with a soft cloth.

Keep the outside clean. Wipe with a clean cloth lightly dampened with kitchen appliance wax or mild liquid dish detergent. Dry and polish with a clean, soft cloth.

The stainless steel panels and door handles (on some models) can be cleaned with a commercially available stainless steel cleaner. Do not use appliance wax or polish on the stainless steel.

Do not wipe the refrigerator with a soiled dish cloth or wet towel. These may leave a residue that can erode the paint. Do not use scouring pads, powdered cleaners, bleach or cleaners containing bleach because these products can scratch and weaken the paint finish.

Cleaning the Inside

To help prevent odors, leave an open box of baking soda in the fresh food and freezer compartments.

Unplug the refrigerator before cleaning. If this is not practical, wring excess moisture out of sponge or cloth when cleaning around switches, lights or controls.

Use warm water and baking soda solution—about a tablespoon (15 ml) of baking soda to a quart (1 liter) of water. This both cleans and neutralizes odors. Rinse and wipe dry.

After cleaning the door gaskets, apply a thin layer of petroleum jelly to the door gaskets at the hinge side. This helps keep the gaskets from sticking and bending out of shape.

Avoid cleaning cold glass shelves (on some models) with hot water because the extreme temperature difference may cause them to break. Handle glass shelves carefully. Bumping tempered glass can cause it to shatter.

Do not wash any plastic refrigerator parts in the dishwasher.

Condenser

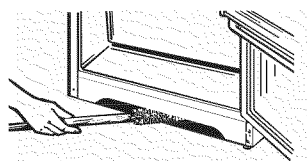

Cleaning the condenser coils.

There is no need for routine condenser cleaning in normal home operating environments. However, in environments that may be particularly dusty or greasy, the condenser should be

cleaned periodically for efficient refrigerator operation.

To clean the condenser, turn the temperature control dial to **OFF**. Sweep away or vacuum up dust.

For best results, use a brush specially designed for this purpose. It is available at most appliance parts stores.

Moving the Refrigerator

Be careful when moving the refrigerator away from the wall. All types of floor coverings can be damaged, particularly cushioned coverings and those with embossed surfaces.

Turn the leveling legs at each front corner of the refrigerator counterclockwise until the rollers support the refrigerator. Pull the refrigerator straight out and return it to position by pushing it straight in. Moving the refrigerator in a side direction may result in damage to the floor covering or refrigerator.

When pushing the refrigerator back, make sure you don't roll over the power cord or icemaker supply line (on some models).

After rolling the refrigerator back into place, turn the legs clockwise until the legs again bear the weight of the refrigerator.

Light Bulb Replacement

To replace a burned-out bulb, unplug the refrigerator from its electrical outlet, unscrew the bulb when cool and replace it with an appliance bulb of the same or lower wattage.

Turning the control to the **OFF** position does not remove power to the light circuit.

Preparing for Vacation

For long vacations or absences, remove food and unplug the refrigerator. Move the temperature control dial to the **OFF** position, and clean the interior with a baking soda solution of one tablespoon (15 ml) of baking soda to one quart (1 liter) of water. Leave the doors open.

Move the feeler arm to the **STOP** (up) position, or move the switch to the **OFF** position on the slide switch model and shut off the water supply to the refrigerator.

If the temperature can drop below freezing, have a qualified servicer drain the water supply system (on some models) to prevent serious property damage due to flooding.

Preparing to Move

Secure all loose items such as grille, shelves and drawers by taping them securely in place to prevent damage. Be sure the refrigerator stays in an upright position during moving.

Installation Instructions *Models 16, 17, 18*

If you have questions, call 1.800.GE.CARES or visit our Website at: GEAppliances.com
In Canada, call 1.800.561.3344 or Visit our Website at: www.geappliances.ca

BEFORE YOU BEGIN

Read these instructions completely and carefully.

- **IMPORTANT** – Save these instructions for local inspector's use.
- **IMPORTANT** – Observe all governing codes and ordinances.
- **Note to Installer** – Be sure to leave these instructions with the Consumer.
- **Note to Consumer** – Keep these instructions for future reference.
- **Skill level** – Installation of this appliance requires basic mechanical skills.
- **Completion time** – Refrigerator Installation
15 minutes
Reversing the Door Swing
1 hour
- Proper installation is the responsibility of the installer.
- Product failure due to improper installation is not covered under the Warranty.

WATER SUPPLY TO THE ICEMAKER (on some models)

If the refrigerator has an icemaker, it will have to be connected to a cold water line. A water supply kit (containing copper tubing, shutoff valve, fittings and instructions) is available at extra cost from your dealer, by visiting our Website at GEAppliances.com (in Canada at www.geappliances.ca) or from Parts and Accessories, 1.800.661.1616.

REFRIGERATOR LOCATION

- Do not install the refrigerator where the temperature will go below 60°F (16°C) because it will not run often enough to maintain proper temperatures.
- Install it on a floor strong enough to support it fully loaded.

CLEARANCES

Allow the following clearances for ease of installation, proper air circulation and plumbing and electrical connections.

- Sides 3/4" (19 mm)
- Top 1" (25 mm)
- Back 2" (50 mm)

ROLLERS AND LEVELING LEGS

Leveling legs near each front corner of the refrigerator are adjustable. They firmly position the refrigerator and prevent it from moving when the doors are opened. Leveling legs should be set so the front of the refrigerator is raised just enough that the doors close easily when opened about halfway.

Turn the leveling legs **clockwise to raise** the refrigerator, **counterclockwise to lower it**.

Rollers next to the leveling legs allow you to move the refrigerator away from the wall for cleaning.

Turn the legs counterclockwise until the weight of the refrigerator is transferred from them to the rollers. After rolling the refrigerator back into place, turn the legs clockwise until the legs again bear the weight of the refrigerator.

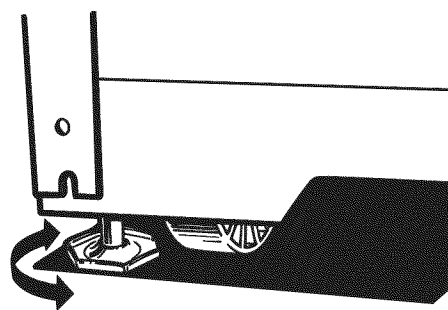

Installation Instructions

1 INSTALLING THE WATER LINE (ON SOME MODELS)

BEFORE YOU BEGIN

Recommended copper water supply kits are WX8X2, WX8X3 or WX8X4, depending on the amount of tubing you need. Approved plastic water supply lines are GE SmartConnect™ Refrigerator Tubing (WX08X10006, WX08X10015 and WX08X10025).

When connecting your refrigerator to a GE Reverse Osmosis Water System, the only approved installation is with a GE RVKit. For other reverse osmosis water systems, follow the manufacturer's recommendations.

This water line installation is not warranted by the refrigerator or icemaker manufacturer. Follow these instructions carefully to minimize the risk of expensive water damage.

Water hammer (water banging in the pipes) in house plumbing can cause damage to refrigerator parts and lead to water leakage or flooding. Call a qualified plumber to correct water hammer before installing the water supply line to the refrigerator.

To prevent burns and product damage, do not hook up the water line to the hot water line.

If you use your refrigerator before connecting the water line, make sure the switch is set to **OFF** or the feeler arm in the **STOP** (up) position.

Do not install the icemaker tubing in areas where temperatures fall below freezing.

When using any electrical device (such as a power drill) during installation, be sure the device is double insulated or grounded in a manner to prevent the hazard of electric shock, or is battery powered.

All installations must be in accordance with local plumbing code requirements.

WHAT YOU WILL NEED

- **Copper or GE SmartConnect™ Refrigerator Tubing kit**, 1/4" outer diameter to connect the refrigerator to the water supply. If using copper, be sure both ends of the tubing are cut square.

To determine how much tubing you need: measure the distance from the water valve on the back of the refrigerator to the water supply pipe. Then add 8' (2.4 m). Be sure there is sufficient extra tubing (about 8' [2.4 m] coiled into 3 turns of about 10" [25 cm] diameter) to allow the refrigerator to move out from the wall after installation.

WHAT YOU WILL NEED (CONT.)

GE SmartConnect™ Refrigerator Tubing Kits are available in the following lengths:

- 6' (1.8 m) – WX08X10006
- 15' (4.6 m) – WX08X10015
- 25' (7.6 m) – WX08X10025

Be sure that the kit you select allows at least 8' (2.4 m) as described above.

NOTE: The only GE approved plastic tubing is that supplied in GE SmartConnect™ Refrigerator Tubing kits. Do not use any other plastic water supply line because the line is under pressure at all times. Certain types of plastic will crack or rupture with age and cause water damage to your home.

- **A GE water supply kit** (containing tubing, shutoff valve and fittings listed below) is available at extra cost from your dealer or from Parts and Accessories, 1.800.661.1616.
- **A cold water supply.** The water pressure must be between 20 and 120 p.s.i. (1.4–8.1 bar).
- **Power drill.**
- **1/2" or adjustable wrench.**
- **Straight and Phillips blade screwdriver.**
- **Two 1/4" outer diameter compression nuts and 2 ferrules (sleeves)**—to connect the copper tubing to the shutoff valve and the refrigerator water valve.

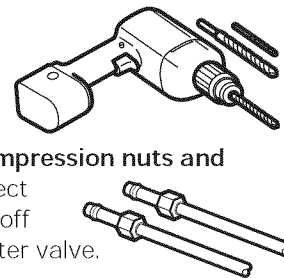

OR

- If you are using a GE SmartConnect™ Refrigerator Tubing kit, the necessary fittings are preassembled to the tubing.
- If your existing copper water line has a flared fitting at the end, you will need an **adapter** (available at plumbing supply stores) to connect the water line to the refrigerator **OR** you can cut off the flared fitting with a **tube cutter** and then use a compression fitting. Do not cut formed end from GE SmartConnect™ Refrigerator tubing.

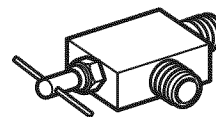

- **Shutoff valve** to connect to the cold water line. The shutoff valve should have a water inlet with a minimum inside diameter of 5/32" at the point of connection to the **COLD WATER LINE**. Saddle-type shutoff valves are included in many water supply kits. Before purchasing, make sure a saddle-type valve complies with your local plumbing codes.

Installation Instructions

Install the shutoff valve on the nearest frequently used drinking water line.

1 SHUT OFF THE MAIN WATER SUPPLY AND UNPLUG REFRIGERATOR

Turn on the nearest faucet (counterclockwise) long enough to clear the line of water.

2 DRILL THE HOLE FOR THE VALVE

Choose a location for the valve that is easily accessible. It is best to connect into the side of a vertical water pipe. When it is necessary to connect into a horizontal water pipe, make the connection to the top or side, rather than at the bottom, to avoid drawing off any sediment from the water pipe.

Drill a 1/4" hole in the water pipe (even if using a self-piercing valve), using a sharp bit. Remove any burrs resulting from drilling the hole in the pipe. **Take care not to allow water to drain into the drill.** Failure to drill a 1/4" hole may result in reduced ice production or smaller cubes.

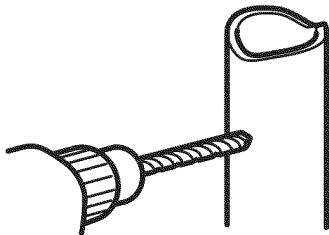

3 FASTEN THE SHUTOFF VALVE

Fasten the shutoff valve to the cold water pipe with the pipe clamp.

Tighten the clamp screws until the sealing washer begins to swell.

NOTE: Do not overtighten or you may crush the tubing.

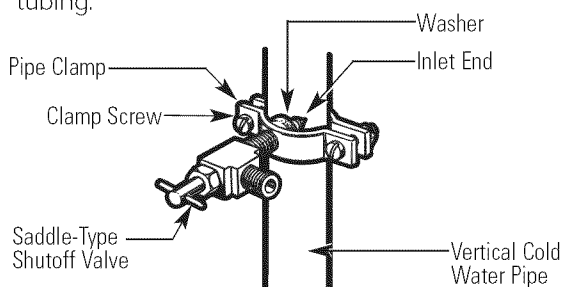

NOTE: Commonwealth of Massachusetts Plumbing Codes 248CMR shall be adhered to. Saddle valves are illegal and use is not permitted in Massachusetts. Consult with your licensed plumber.

4 ROUTE THE TUBING

Route the tubing between the cold water line and the refrigerator.

Route the tubing through a hole drilled in the wall or floor (behind the refrigerator or adjacent base cabinet) as close to the wall as possible.

NOTE: Be sure there is sufficient extra tubing (about 8 feet [244 cm] coiled into 3 turns of about 10" [25 cm] diameter) to allow the refrigerator to move out from the wall after installation.

5 CONNECT THE TUBING TO THE VALVE

Place the compression nut and ferrule (sleeve) for copper tubing onto the end of the tubing and connect it to the shutoff valve.

Make sure the tubing is fully inserted into the valve. Tighten the compression nut securely.

For plastic tubing from a GE SmartConnect™ Refrigerator Tubing kit, insert the molded end of the tubing into the shutoff valve and tighten compression nut until it is hand tight, then tighten one additional turn with a wrench. Overtightening may cause leaks.

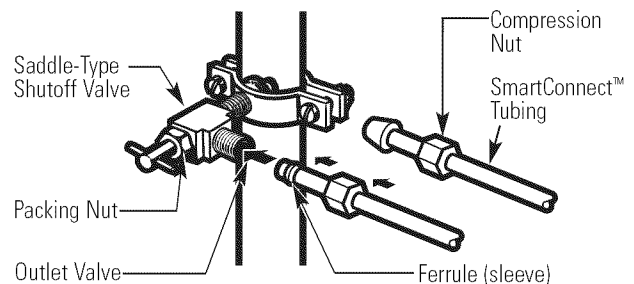

NOTE: Commonwealth of Massachusetts Plumbing Codes 248CMR shall be adhered to. Saddle valves are illegal and use is not permitted in Massachusetts. Consult with your licensed plumber.

6 FLUSH OUT THE TUBING

Turn the main water supply on (counterclockwise) and flush out the tubing until the water is clear.

Shut the water off at the water valve after about one quart (1 liter) of water has been flushed through the tubing.

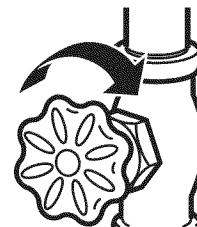

Installation Instructions

1 INSTALLING THE WATER LINE (CONT.)

7 CONNECT THE TUBING TO THE REFRIGERATOR

NOTES:

- Before making the connection to the refrigerator, be sure the refrigerator power cord is not plugged into the wall outlet.
- We recommend installing a water filter if your water supply has sand or particles that could clog the screen of the refrigerator's water valve. Install it in the water line near the refrigerator. If using GE SmartConnect™ Refrigerator Tubing kit, you will need an additional tube (WX08X10002) to connect the filter. Do not cut plastic tube to install filter.

Remove the access cover.

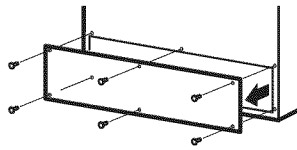

Remove the plastic flexible cap from the water valve (refrigerator connection).

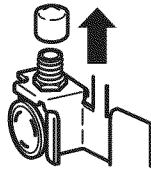

Place the compression nut and ferrule (sleeve) onto the end of the tubing as shown. On GE SmartConnect™ Refrigerator Tubing kit, the nuts are already assembled to the tubing.

Insert the end of the tubing into the water valve connection as far as possible. While holding the tubing, tighten the fitting.

For plastic tubing from a GE SmartConnect™ Refrigerator Tubing kit, insert the molded end of the tubing into the shutoff valve and tighten compression nut until it is hand tight, then tighten one additional turn with a wrench. Overtightening may cause leaks.

Fasten the tubing into the clamp provided to hold it in a vertical position. You may need to pry open the clamp.

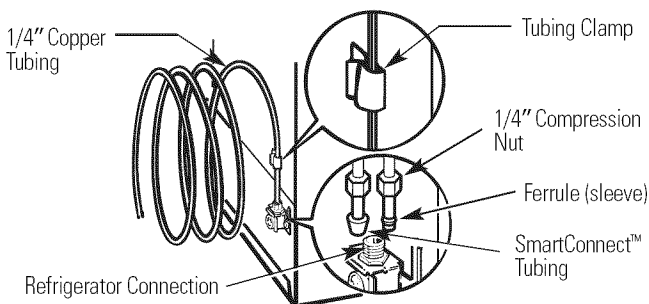

Reattach the access cover.

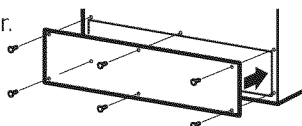

8 TURN THE WATER ON AT THE SHUTOFF VALVE

Tighten any connections that leak.

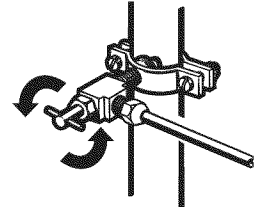

9 PLUG IN THE REFRIGERATOR

Arrange the coil of tubing so that it does not vibrate against the back of the refrigerator or against the wall. Push the refrigerator back to the wall.

10 START THE ICEMAKER

On power switch models, set the icemaker power switch to the **ON** position. On feeler arm models, move the feeler arm to the **ON** (down) position. The icemaker will not begin to operate until it reaches its operating temperature of 15°F (-9°C) or below. It will then begin operation automatically.

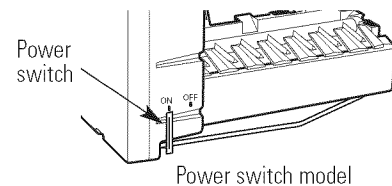

Power switch model

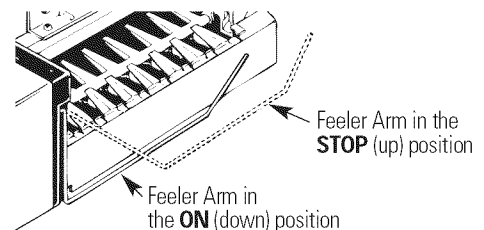

Feeler arm model

NOTE: In lower water pressure conditions, the water valve may turn on up to 3 times to deliver enough water to the icemaker.

Installation Instructions

2 REVERSING THE DOOR SWING

IMPORTANT NOTES

When reversing the door swing:

- Read the instructions all the way through before starting.
- Handle parts carefully to avoid scratching paint.
- Set screws down by their related parts to avoid using them in the wrong places.
- Provide a non-scratching work surface for the doors.

IMPORTANT: Once you begin, do not move the cabinet until door-swing reversal is completed.

These instructions are for changing the hinges from the right side to the left side—if you ever want to change the hinges back to the right side, follow these same instructions and reverse all references to left and right.

TOOLS REQUIRED



Phillips screwdriver

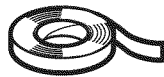

Masking tape



5/16" hex-head socket driver



T20 or T25 Torxdriver (needed for some models)

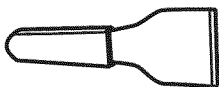

Putty knife or thin-blade screwdriver



5/16" open-end wrench

1 BEFORE YOU START

1.1 Unplug the refrigerator from its electrical outlet.

1.2 Empty all door shelves, including the dairy compartment.

CAUTION: Do not let either door drop to the floor. To do so could damage the door stop.

2 REMOVE THE FREEZER DOOR

2.1 Tape the door shut with masking tape.

2.2 With a 5/16" hex-head socket driver, remove the screws that hold the top hinge to the cabinet.

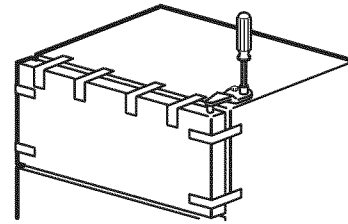

2.3 Lift the hinge straight up to free the hinge pin from the socket in the top of the door and set it aside, along with its screws.

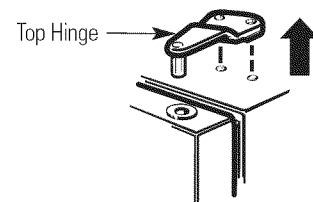

2.4 Remove the tape and tilt the door away from the cabinet. Lift it off the center hinge pin.

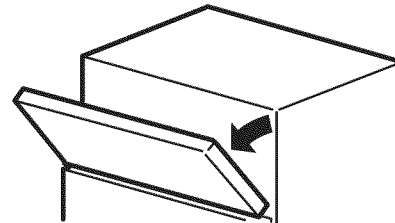

2.5 Set the door on a non-scratching surface with the outside up.

2.6 Transfer the 2 screws from the opposite side of the cabinet to the screw holes vacated by the top hinge removal.

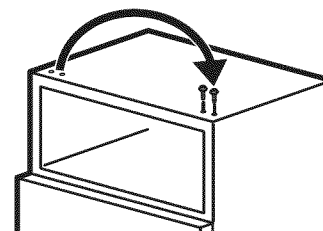

Installation Instructions

2 REVERSING THE DOOR SWING (CONT.)

3 REMOVE THE FRESH FOOD DOOR

3.1 Tape the door shut with masking tape.

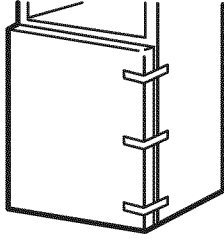

3.2 Using a 5/16" hex-head socket screwdriver and a 5/16" open-end wrench, remove the two screws holding the center hinge to the cabinet. Lift the center hinge to free its pin from the socket in the top of the door, and set hinge and screws aside. **Be careful not to lose the center hinge spacer and washer.**

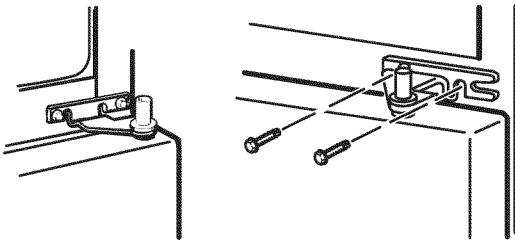

3.3 Remove the tape and tilt the door away from the cabinet. Lift the door from the pin in the bottom hinge bracket. (If the plastic washer sticks to the door bottom, put it back on the hinge.)

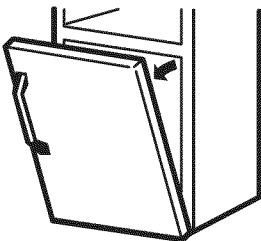

3.4 Set the door outside-up on a non-scratching surface.

3 REMOVE THE FRESH FOOD DOOR (CONT.)

3.5 Transfer the two screws from the opposite side of the cabinet to the screw holes vacated by the center hinge removal.

3.6 Transfer the washer (if your model has one) to the opposite side.

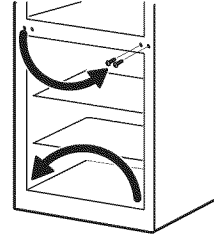

3.7 Take one of the screws removed in step 2 and start it in the outermost screw hole on the opposite side. Do not drive it all the way down—leave enough space under the screw head for thickness of the bracket.

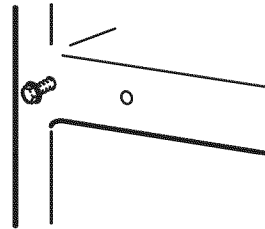

4 REVERSING THE HARDWARE

4.1 Move the bottom hinge bracket and plastic washer from the right side to the left side.

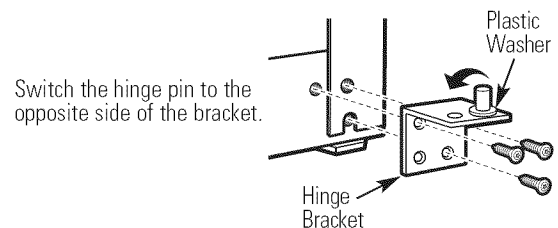

Installation Instructions

4 REVERSING THE HARDWARE (CONT.)

4.2 Interchange hinge and screws at top right with screws at top left of cabinet. **Do not tighten screws on hinge side at this time.**

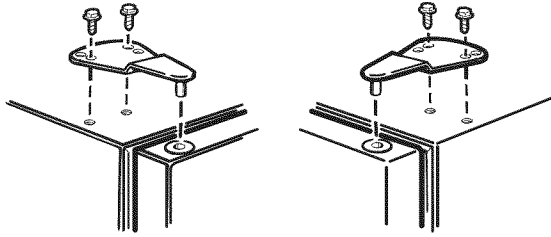

Installing the hinge on the left. Installing the hinge on the right.

NOTES:

- Some hinges have four holes. Which holes you use for installing the hinge depends on which side you install the hinge.
- The outer edge of the hinge should be parallel to the edge of the case for correct installation.

5 REVERSING THE DOOR HANDLES (CONT.)

5.1.3 Remove plug button from the top hinge hole on the left side of the door and insert it into the hole on the opposite side that was vacated by removal of the top hinge.

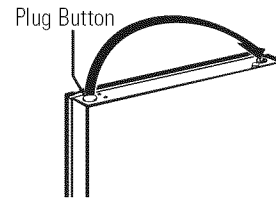

5.1.4 Pull the plug button from the front of the door and transfer it to the opposite side.

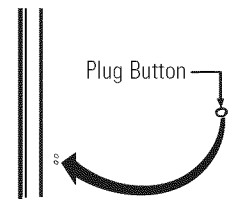

To reattach the handle on the opposite side.

5 REVERSING THE DOOR HANDLES

5.1 Transfer fresh food door handle

5.1.1 Remove the handle plug using a tape-tipped putty knife under the edge, and remove the screw underneath. Remove the two screws holding the handle to the top of the door.

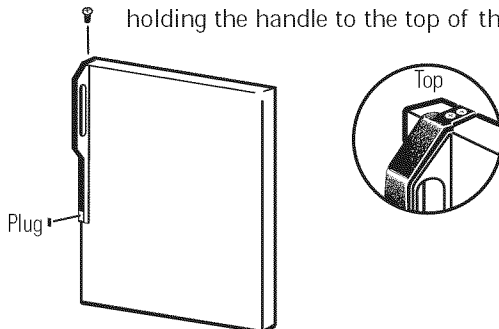

5.1.2 Remove the handle.

5.2 Transfer door stop

5.2.1 Move the plastic door stop and screws from the right side to the left side.

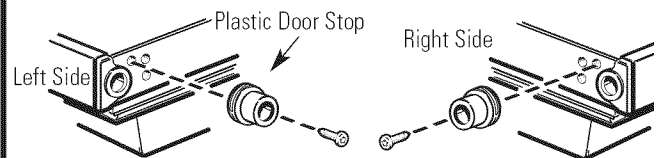

5.2.2 Move the metal door stop from the right side to the left side and transfer the screw to the opposite side of the door.

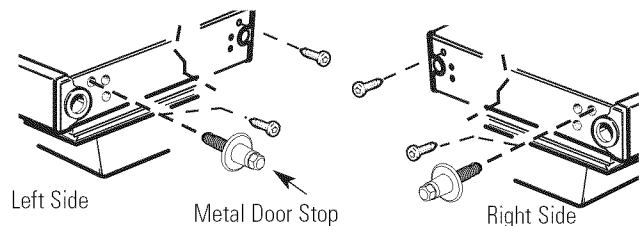

5.3 Reinstall the fresh food door handle

5.3.1 Attach the handle to the right side of the door with screws at the top and under the handle plug.

5.3.2 Reinstall the handle plug.

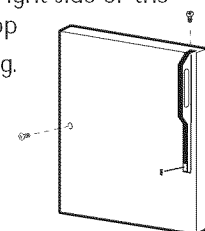

Installation Instructions

2 REVERSING THE DOOR SWING (CONT.)

5 REVERSING THE DOOR HANDLES (CONT.)

5.4 Transfer Freezer Door Handle

5.4.1 Remove the screw holding the handle to the top of the door and the two screws holding the handle to the bottom of the door.

5.4.2 Remove the handle.

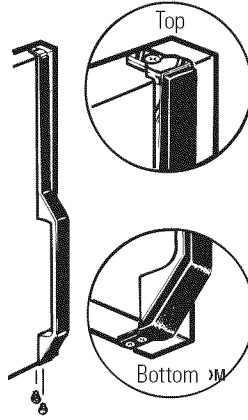

5.4.3 Remove the screw from the right top edge of the door and insert it into the handle screw hole on the left side.

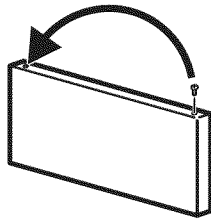

5.4.4 Transfer the door stop as shown in preceding section 5.2.

5.4.5 Attach the handle to the right edge of the door with screws at top and bottom, using bottom holes vacated by removal of the door stop screws.

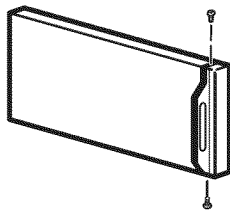

6 RE-HANGING THE DOORS

6.1 Re-hang the fresh food door

6.1.1 Lower the fresh food door onto the bottom hinge pin. **Be sure the washer is in place on the pin.**

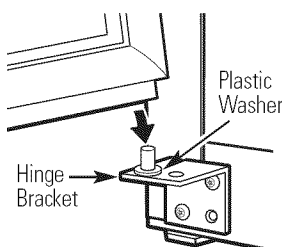

6 RE-HANGING THE DOORS (CONT.)

6.1.2 Insert the pin on the center hinge into the socket in the top of the door. Place the spacer, then the washer, on the hinge pin.

NOTE: The center hinge must be turned over as shown when mounted on the left side.

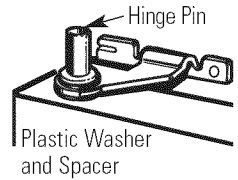

6.1.3 Tilt the door toward the cabinet. As the door is brought into position, slide the hinge under the head of the screw which earlier had been partly driven into the outermost hole. Insert the remaining screw, then tighten both screws securely.

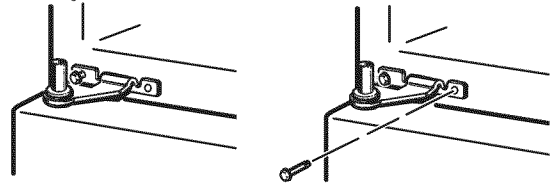

6.2 Re-hang the freezer door

6.2.1 Lower the freezer door onto the center hinge pin. **Be sure the washer and spacer are in place on the pin.**

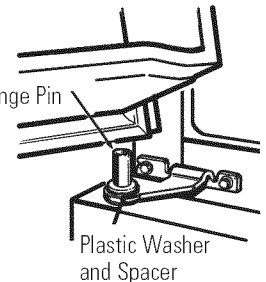

6.2.2 Tilt the door toward the cabinet, lifting the top hinge so the pin fits into the socket on the top of the door.

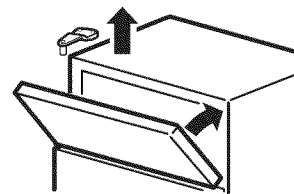

6.2.3 Make sure the door is slightly above the top of the cabinet and the gap between the doors is even across the front. Tighten the top hinge screws. Do not overtighten these screws—tighten them until they are just snug, then turn them another one-half turn.

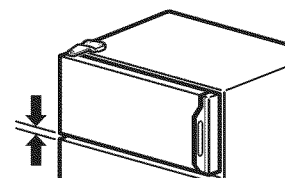



Newer refrigerators sound different from older refrigerators. Modern refrigerators have more features and use newer technology.

Do you hear what I hear? These sounds are normal.

- The new high efficiency compressor may run faster and longer than your old refrigerator and you may hear a high-pitched hum or pulsating sound while it is operating.
- You may hear a whooshing sound when the doors close. This is due to pressure equalizing within the refrigerator.

**HUMMM...
WHOOSH...**

WHIR!



- You may hear the fans spinning at high speeds. This happens when the refrigerator is first plugged in, when the doors are opened frequently or when

a large amount of food is added to the refrigerator or freezer compartments. The fans are helping to maintain the correct temperatures.

CLICKS, POPS, CRACKS and CHIRPS

- You may hear cracking or popping sounds when the refrigerator is first plugged in. This happens as the refrigerator cools to the correct temperature.
- The compressor may cause a clicking or chirping sound when attempting to restart (this could take up to 5 minutes).
- Expansion and contraction of cooling coils during and after defrost can cause a cracking or popping sound.
- On models with an icemaker, after an icemaking cycle, you may hear the ice cubes dropping into the ice bucket.



WATER SOUNDS

- The flow of refrigerant through the freezer cooling coils may make a gurgling noise like boiling water.
- Water dropping on the defrost heater can cause a sizzling, popping or buzzing sound during the defrost cycle.
- A water dripping noise may occur during the defrost cycle as ice melts from the evaporator and flows into the drain pan.
- Closing the door may cause a gurgling sound due to pressure equalization.



For additional information on normal icemaker operating sounds, see the **About the automatic icemaker** section.

Before you call for service...



Troubleshooting Tips
Save time and money! Review the charts on the following pages first and you may not need to call for service.

Problem	Possible Causes	What To Do
Refrigerator does not operate	Refrigerator in defrost cycle.	• Wait about 30 minutes for defrost cycle to end.
	Temperature control dial in OFF position.	• Move the temperature control dial to a temperature setting.
	Refrigerator is unplugged.	• Push the plug completely into the outlet.
	The fuse is blown/circuit breaker is tripped.	• Replace fuse or reset the breaker.
Vibration or rattling (slight vibration is normal)	Roller screws or leveling legs need adjusting.	• See Rollers and Leveling Legs.
Fresh food or freezer compartment too warm	Temperature control dial not set cold enough.	• See About the temperature control dial.
	Warm weather or frequent door openings.	• Set the temperature control dial one step colder. See About the temperature control dial.
	Door left open.	• Check to see if package is holding door open.
	Package blocking air duct in freezer compartment.	• Check to see if package is blocking air duct in freezer compartment.

Before you call for service...



Troubleshooting Tips

Problem	Possible Causes	What To Do
Motor operates for long periods or cycles on and off frequently. (Modern refrigerators with more storage space and a larger space and a larger freezer require more operating time. They start and stop often to maintain even temperatures.)	Normal when refrigerator is first plugged in.	<ul style="list-style-type: none"> • Wait 24 hours for the refrigerator to completely cool down.
	Often occurs when large amounts of food are placed in refrigerator.	<ul style="list-style-type: none"> • This is normal.
	Door left open.	<ul style="list-style-type: none"> • Check to see if package is holding door open.
	Hot weather or frequent door openings.	<ul style="list-style-type: none"> • This is normal.
	Temperature control dial set at the coldest setting.	<ul style="list-style-type: none"> • See About the temperature control dial.
	Grille and condenser need cleaning.	<ul style="list-style-type: none"> • See Care and cleaning.
Frost or ice crystals on frozen food (frost within package is normal)	Door left open.	<ul style="list-style-type: none"> • Check to see if package is holding door open.
	Too frequent or too long door openings.	
Automatic icemaker does not work (on some models)	Icemaker is not on.	<ul style="list-style-type: none"> • Move the feeler arm to the ON (down) position, or move the power switch to the ON position
	Water supply turned off or not connected.	<ul style="list-style-type: none"> • See Installing the water line.
	Freezer compartment too warm.	<ul style="list-style-type: none"> • Wait 24 hours for the refrigerator to completely cool down.
	Piled up cubes in the storage bin cause the icemaker to shut off.	<ul style="list-style-type: none"> • Level cubes by hand.
Frequent "buzzing" sound	Icemaker is on but the water supply to the refrigerator has not been connected	<ul style="list-style-type: none"> • Move the feeler arm to the STOP (up) position, or move the power switch to the OFF position, Keeping it on will damage the water valve..
Cubes too small	Water shutoff valve connecting refrigerator to water line may be clogged.	<ul style="list-style-type: none"> • Call the plumber to clear the valve.
Slow ice cube freezing	Door left open.	<ul style="list-style-type: none"> • Check to see if package is holding door open.
	Temperature control dial not set cold enough.	<ul style="list-style-type: none"> • See About the temperature control dial.
Ice cubes have odor/taste	Ice storage bin needs cleaning.	<ul style="list-style-type: none"> • Empty and wash bin. Discard old cubes.
	Food transmitting odor/taste to ice cubes.	<ul style="list-style-type: none"> • Wrap foods well.
	Interior of refrigerator needs cleaning.	<ul style="list-style-type: none"> • See Care and cleaning.
Moisture forms on cabinet surface between the doors	Not unusual during periods of high humidity.	<ul style="list-style-type: none"> • Wipe surface dry and reset temperature control dial one setting colder.
Moisture collects inside (in humid weather, air carries moisture into refrigerator when doors re opened)	Too frequent or too long door openings.	
Refrigerator has odor	Foods transmitting odor to refrigerator.	<ul style="list-style-type: none"> • Foods with strong odors should be tightly wrapped. • Keep an open box of baking soda in the refrigerator; replace every three months.
	Interior needs cleaning.	<ul style="list-style-type: none"> • See Care and cleaning.

Refrigerator Warranty. (For customers in the United States)

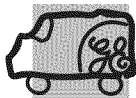

All warranty service provided by our Factory Service Centers, or an authorized Customer Care® technician. To schedule service, on-line, 24 hours a day, visit us at GEAppliances.com, or call 800.GE.CARES (800.432.2737). Please have serial number and model number available when calling for service.

Staple your receipt here. Proof of the original purchase date is needed to obtain service under the warranty.

For The Period Of: GE Will Replace:

GE and GE PROFILE MODELS:

<p>One Year From the date of the original purchase</p>	<p>Any part of the refrigerator which fails due to a defect in materials or workmanship. During this limited one-year warranty, GE will also provide, free of charge, all labor and related service to replace the defective part.</p>
<p>Thirty Days (Water filter, if included) From the original purchase date of the refrigerator</p>	<p>Any part of the water filter cartridge which fails due to a defect in materials or workmanship. During this limited thirty-day warranty, GE will also provide, free of charge, a replacement water filter cartridge.</p>

GE PROFILE MODELS ONLY:

<p>Five Years (GE Profile models only) From the date of the original purchase</p>	<p>Any part of the sealed refrigerating system (the compressor, condenser, evaporator and all connecting tubing) which fails due to a defect in materials or workmanship. During this limited five-year sealed refrigerating system warranty, GE will also provide, free of charge, all labor and related service to replace the defective part in the sealed refrigerating system.</p>
---	---

What GE Will Not Cover:

- Service trips to your home to teach you how to use the product.
- Improper installation, delivery or maintenance.
- Failure of the product if it is abused, misused, or used for other than the intended purpose or used commercially.
- Loss of food due to spoilage.
- Replacement of house fuses or resetting of circuit breakers.
- Damage caused after delivery.
- Products which are not defective, broken or which are working as described in the Owner's manual.
- Replacement of the water filter cartridge, if included, due to water pressure that is outside the specified operating range or due to excessive sediment in the water supply.
- Replacement of the light bulbs, if included, or water filter cartridge, if included, other than as noted above.
- Damage to the product caused by accident, fire, floods or acts of God.
- Incidental or consequential damage caused by possible defects with this appliance.
- Product not accessible to provide required service.

EXCLUSION OF IMPLIED WARRANTIES—Your sole and exclusive remedy is product repair as provided in this Limited Warranty. Any implied warranties, including the implied warranties of merchantability or fitness for a particular purpose, are limited to one year or the shortest period allowed by law.

This warranty is extended to the original purchaser and any succeeding owner for products purchased for home use within the USA. If the product is located in an area where service by a GE Authorized Servicer is not available, you may be responsible for a trip charge or you may be required to bring the product to an Authorized GE Service location for service. In Alaska, the warranty excludes the cost of shipping or service calls to your home.

Some states do not allow the exclusion or limitation of incidental or consequential damages. This warranty gives you specific legal rights, and you may also have other rights which vary from state to state. To know what your legal rights are, consult your local or state consumer affairs office or your state's Attorney General.

Consumer Support.



GE Appliances Website

GEAppliances.com

In the U.S.: **www.Hotpoint.com**

Have a question or need assistance with your appliance? Try the GE Appliances Website 24 hours a day, any day of the year! For greater convenience and faster service, you can now download Owner's Manuals, order parts, or even schedule service on-line. **In Canada: www.geappliances.ca**

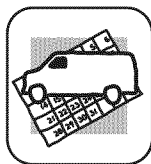

Schedule Service

GEAppliances.com

In the U.S.: **www.Hotpoint.com**

Expert GE repair service is only one step away from your door. Get on-line and schedule your service at your convenience 24 hours any day of the year! Or call 800.GE.CARES (800.432.2737) during normal business hours.

In Canada, call 1.800.561.3344

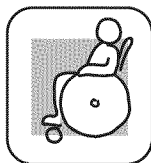

Real Life Design Studio

In the U.S.: **GEAppliances.com**

GE supports the Universal Design concept—products, services and environments that can be used by people of all ages, sizes and capabilities. We recognize the need to design for a wide range of physical and mental abilities and impairments. For details of GE's Universal Design applications, including kitchen design ideas for people with disabilities, check out our Website today. For the hearing impaired, please call 800.TDD.GEAC (800.833.4322).

In Canada, contact: Manager, Consumer Relations, Mabe Canada Inc.
Suite 310, 1 Factory Lane
Moncton, N.B. E1C 9M3



Extended Warranties

In the U.S.: **GEAppliances.com**

Purchase a GE extended warranty and learn about special discounts that are available while your warranty is still in effect. You can purchase it on-line anytime, or call 1.888.261.2133 during normal business hours. GE Consumer Home Services will still be there after your warranty expires.

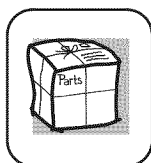

Parts and Accessories

GEAppliances.com

In the U.S.: **www.Hotpoint.com**

Individuals qualified to service their own appliances can have parts or accessories sent directly to their homes (VISA, MasterCard and Discover cards are accepted). Order on-line today, 24 hours every day or by phone at 1.800.661.1616 during normal business hours.

Instructions contained in this manual cover procedures to be performed by any user. Other servicing generally should be referred to qualified service personnel. Caution must be exercised, since improper servicing may cause unsafe operation. Customers **in Canada** should consult the yellow pages for the nearest Mabe service center, or call 1.800.661.1616.



Contact Us

GEAppliances.com

In the U.S.: **www.Hotpoint.com**

If you are not satisfied with the service you receive from GE, contact us on our Website with all the details including your phone number, or write to:

General Manager, Customer Relations
GE Appliances, Appliance Park
Louisville, KY 40225

In Canada: www.geappliances.ca, or write to: Director, Consumer Relations, Mabe Canada Inc.
Suite 310, 1 Factory Lane
Moncton, N.B. E1C 9M3



Register Your Appliance

GEAppliances.com

In the U.S.: **www.Hotpoint.com**

Register your new appliance on-line—at your convenience! Timely product registration will allow for enhanced communication and prompt service under the terms of your warranty, should the need arise. You may also mail in the pre-printed registration card included in the packing material.

In Canada: www.geappliances.ca



Top-Freezer Refrigerators

Safety Instructions 2-4

Operating Instructions

Automatic Icemaker 7
Care and Cleaning 8
Shelves 5, 6
Storage Drawers 6
Temperature Controls 5

Installation Instructions

Preparing to Install
the Refrigerator 9
Reversing the Door Swing 13-16
Water Line Installation 10-12

Troubleshooting Tips

Before You Call For Service 17, 18
Normal Operating Sounds 17

Consumer Support

Consumer Support Back Cover
Refrigerator Warranty 19

**Owner's Manual and
Installation Instructions**

Models 16, 17, 18

**Write the model and serial
numbers here:**

Model # _____

Serial # _____

You can find them on a label on
the upper left side of the fresh food
compartment.

IMPORTANT SAFETY INFORMATION. READ ALL INSTRUCTIONS BEFORE USING.

⚠ DANGER! RISK OF CHILD ENTRAPMENT PROPER DISPOSAL OF THE REFRIGERATOR

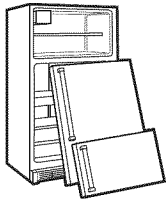

Child entrapment and suffocation are not problems of the past. Junked or abandoned refrigerators are still dangerous...even if they will sit for "just a few days." If you are getting rid of your old refrigerator, please follow the instructions below to help prevent accidents.

Before You Throw Away Your Old Refrigerator or Freezer:

- Take off the doors.
- Leave the shelves in place so that children may not easily climb inside.
- If the refrigerator has a lock make it unusable

Refrigerants

All refrigeration products contain refrigerants, which under federal law must be removed prior to product disposal. If you are getting rid of an old refrigeration product, check with the company handling the disposal about what to do.

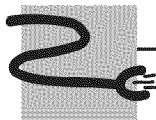

USE OF EXTENSION CORDS

Because of potential safety hazards under certain conditions, we strongly recommend against the use of an extension cord.

However, if you must use an extension cord, it is absolutely necessary that it be a UL-listed (in the United States) or a CSA certified (in Canada), 3-wire grounding type appliance extension cord having a grounding type plug and outlet and that the electrical rating of the cord be 15 amperes (minimum) and 120 volts.

⚠ DANGER! RISQUES POUR LES ENFANTS COMMENT VOUS DÉBARRASSER CONVENABLEMENT DE VOTRE ANCIEN RÉFRIGÉRATEUR

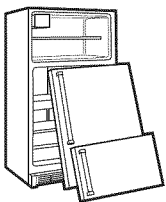

Les enfants pris au piège ou morts d'asphyxie sont toujours d'actualité. Les réfrigérateurs abandonnés sont toujours aussi dangereux, même si on n'attend que «quelques jours» pour s'en débarrasser. Si vous ne gardez pas votre ancien réfrigérateur, veuillez suivre les directives ci-dessous afin de prévenir les accidents.

Avant de vous débarrasser de votre ancien réfrigérateur ou congélateur :

- Démontez les portes.
- Laissez les clayettes en place afin d'empêcher les enfants de grimper à l'intérieur.

Réfrigérants

Tous les appareils de réfrigération contiennent des réfrigérants qui, conformément aux lois fédérales, doivent être enlevés avant toute élimination de l'appareil. Si vous vous débarrassez de vieux appareils de réfrigération, vérifiez, auprès de la société qui s'occupe de leur élimination, ce que vous devez faire.

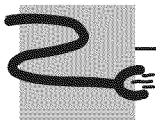

CORDONS PROLONGATEURS

Nous vous recommandons fortement de ne pas utiliser de cordons prolongateurs à cause des risques potentiels qu'ils présentent dans certaines conditions.

Toutefois si vous décidez d'utiliser tout de même un cordon prolongateur, il est absolument nécessaire qu'il s'agisse d'un cordon à 3 fils avec mise à la terre pour appareils électroménagers homologué UL (aux États-Unis) ou certifié CSA (au Canada), pourvu d'une fiche et d'une prise mises à la terre de 15 ampères (minimum) et de 120 volts.

IMPORTANT SAFETY INFORMATION. READ ALL INSTRUCTIONS BEFORE USING.

GEAppliances.com

⚠ WARNING!

Use this appliance only for its intended purpose as described in this Owner's Manual.



SAFETY PRECAUTIONS

When using electrical appliances, basic safety precautions should be followed, including the following:

- This refrigerator must be properly installed and located in accordance with the Installation Instructions before it is used.
- Do not attempt to or allow children to climb, stand or hang on the shelves in the refrigerator. They could damage the refrigerator and seriously injure themselves.
- Do not touch the cold surfaces in the freezer compartment when hands are damp or wet. Skin may stick to these extremely cold surfaces.
- Do not store or use gasoline or other flammable vapors and liquids in the vicinity of this or any other appliance.
- Keep fingers out of the "pinch point" areas; clearances between the doors and between the doors and cabinet are necessarily small. Be careful closing doors when children are in the area.
- Unplug the refrigerator before cleaning and making repairs.
- In refrigerators with automatic icemakers, avoid contact with the moving parts of the ejector mechanism, or with the heating element that releases the cubes. Do not place fingers or hands on the automatic icemaking mechanism while the refrigerator is plugged in.

NOTE: We strongly recommend that any servicing be performed by a qualified individual.
- Turning the temperature control to the **OFF** position does not remove power to the light circuit.
- Do not refreeze frozen foods which have thawed completely.
- Do not allow children to play with refrigerator or tamper with controls.
- **Before replacing a burned-out light bulb, the refrigerator should be unplugged** in order to avoid contact with a live wire filament. (A burned-out light may break when being replaced.)

MESURES DE SÉCURITÉ IMPORTANTES. LISEZ D'ABORD TOUTES LES DIRECTIVES.

⚠ AVERTISSEMENT!

N'utilisez cet électroménager que pour l'usage auquel il est destiné, comme expliqué dans le présent manuel.



MESURES DE SÉCURITÉ

Lorsque vous utilisez un appareil électrique, observez toujours les mesures de sécurité de base, y compris les suivantes.

- Installez le réfrigérateur conformément aux directives d'installation avant de l'utiliser.
- Ne laissez pas les enfants grimper, s'asseoir, se tenir debout ni se pendre aux clayettes du réfrigérateur. Ils pourraient endommager le réfrigérateur et se blesser gravement.
- N'entreposez et n'utilisez pas d'essence ou autres vapeurs et liquides inflammables à proximité de cet appareil ou de tout autre appareil électroménager.
- Éloignez les doigts des parties du réfrigérateur où l'on peut facilement se pincer : les espaces entre les portes et entre les portes et les placards sont toujours étroits. Soyez prudent lorsque vous fermez les portes de l'appareil en présence des enfants.
- Débranchez votre réfrigérateur avant de le nettoyer ou de le réparer.
- Si votre réfrigérateur est doté d'une machine à glaçons automatique évitez le contact avec les pièces mobiles du mécanisme éjecteur, ou avec l'élément chauffant qui libère les glaçons.
Ne posez pas les doigts ou les mains sur le mécanisme de la machine à glaçons pendant que le réfrigérateur est branché.
- Ne touchez pas les surfaces froides du congélateur si vous avez les mains humides ou mouillées : la peau risque d'adhérer à ces surfaces très froides.

REMARQUE : Nous vous recommandons vivement de confier toute réparation à un technicien qualifié.
- Lorsque vous réglez la commande sur 0 (éteint), l'alimentation électrique de l'ampoule n'est pas coupée.
- Ne recongelez pas les aliments surgelés qui ont complètement dégelé.
- Le réfrigérateur doit être débranché avant de remplacer l'ampoule afin d'éviter tout contact avec un fil de câble sous tension.

IMPORTANT SAFETY INFORMATION. READ ALL INSTRUCTIONS BEFORE USING.

⚠ WARNING!

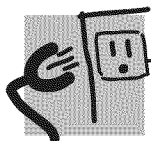

HOW TO CONNECT ELECTRICITY

Do not, under any circumstances, cut or remove the third (ground) prong from the power cord. For personal safety, this appliance must be properly grounded.

The power cord of this appliance is equipped with a 3-prong (grounding) plug which mates with a standard 3-prong (grounding) wall outlet to minimize the possibility of electric shock hazard from this appliance.

Have the wall outlet and circuit checked by a qualified electrician to make sure the outlet is properly grounded.

Where a standard 2-prong wall outlet is encountered, it is your personal responsibility and obligation to have it replaced with a properly grounded 3-prong wall outlet.

The refrigerator should always be plugged into its own individual electrical outlet which has a voltage, wattage and frequency that match the rating plate.

This provides the best performance and also prevents overloading house wiring circuits which could cause a fire hazard from overheated wires.

Never unplug your refrigerator by pulling on the power cord. Always grip plug firmly and pull straight out from the outlet.

Repair or replace immediately all power cords that have become frayed or otherwise damaged. Do not use a cord that shows cracks or abrasion damage along its length or at either end.

When moving the refrigerator away from the wall, be careful not to roll over or damage the power cord.



READ AND FOLLOW THIS SAFETY INFORMATION CAREFULLY.

SAVE THESE INSTRUCTIONS

MESURES DE SÉCURITÉ IMPORTANTES. LISEZ D'ABORD TOUTES LES DIRECTIVES.

⚠ AVERTISSEMENT!

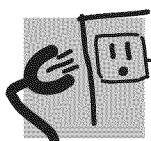

RACCORDEMENT ÉLECTRIQUE

Ne coupez ni retirez en aucun cas la troisième broche (mise à la terre) de la fiche du cordon d'alimentation. Pour votre sécurité, cet appareil doit être correctement mis à la terre.

Le cordon d'alimentation de cet appareil est muni d'une fiche à 3 broches (mise à la terre) qui se branche dans une prise murale ordinaire à 3 alvéoles (mise à la terre) pour réduire au minimum les risques de chocs électriques.

Faites examiner la prise de courant et le circuit par un électricien qualifié pour vous assurer que la prise est correctement mise à la terre.

Si la prise murale est du type standard à 2 alvéoles, il vous incombe de la faire remplacer par une prise à 3 alvéoles correctement mise à la terre.

Le réfrigérateur doit toujours être branché dans sa propre prise de courant, dont la tension nominale est identique à celle indiquée sur la plaque signalétique.

Cette précaution est recommandée pour garantir un rendement optimum et éviter une surcharge des circuits électriques de la résidence, ce qui pourrait créer un risque d'incendie par surchauffe des fils.

Ne débranchez jamais le réfrigérateur en tirant sur le cordon d'alimentation. Saisissez fermement la fiche du cordon et tirez droit pour la retirer de la prise.

Réparez ou remplacez immédiatement tout cordon effiloché ou endommagé. N'utilisez pas un cordon fendillé ou présentant des signes d'usure.

Lorsque vous déplacez votre réfrigérateur du mur, faites attention de ne pas le faire rouler sur le cordon d'alimentation afin de ne pas l'endommager.



VEUILLEZ LIRE ET SUIVRE ATTENTIVEMENT CES MESURES DE SÉCURITÉ. CONSERVEZ CES DIRECTIVES

About the temperature control dial.

Turning the dial to **0/ Off** stops cooling in both compartments—fresh food and freezer. It does not shut off power to the refrigerator.

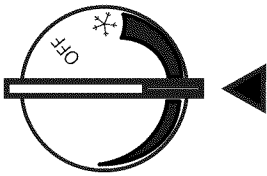

Temperature Control Dial (on some models)

The temperature control dial adjust refrigerator from warmest to coldest. The recommended factory setting is shown in illustration to the left. For colder temperature turn dial clockwise toward snowflake. For warmer temperature turn dial counter clockwise away from snowflake. allow 24 hours for adjustment.

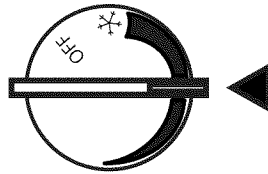

Recommended factory setting

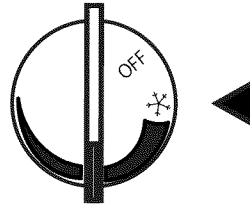

Coldest setting

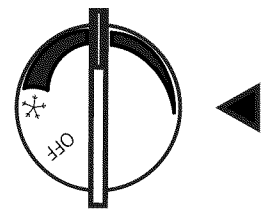

Warmest setting

About the fresh food compartment shelves.

Shelf supports at various levels allow you to custom-space your shelves. Not all features are on all models.

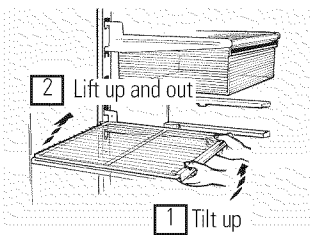

Half-Width Shelves

One end of the shelf rests on a molded side-wall support; a bracket on the other end hooks into a track on the rear cabinet wall. To remove, lift the shelf up at front, then off the support and out of the track. To replace, select desired shelf height. With shelf front raised slightly, hook the bracket's top lug into the track, then lower the shelf onto the support.

NOTE: The shelf to the right of the track is designed to hook into the right-hand slot; the shelf to the left is designed to hook into the left-hand slot.

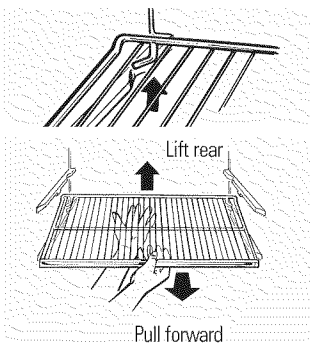
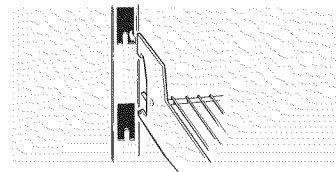

To remove the full-width shelves

Full-Width Shelves

Some models have a stationary tempered glass shelf, a spillproof shelf, or two steel wire stationary shelves. These shelves can be moved to another place in the fresh food compartment.

When placed correctly on the shelf supports, the shelf will stop before coming completely out of the refrigerator and will not tilt when you place food on it or remove food from it.

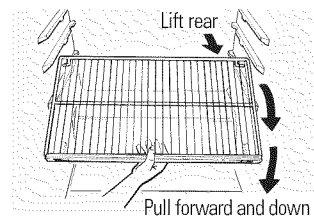

To remove a full-width shelf when the fresh food compartment door cannot be opened fully

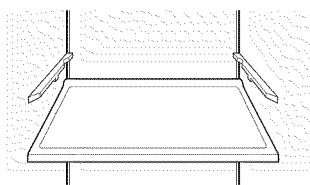

Spillproof Shelves (on some models)

Spillproof shelves have special edges to help prevent spills from dripping to lower shelves. To remove or replace the shelves, see the above instructions.

About the freezer compartment shelves.

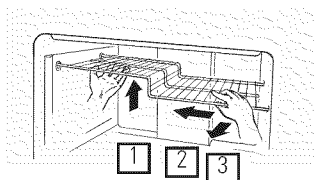

Step Shelf (on some models)

To remove the step shelf:

- 1 Lift left side of shelf slightly.
- 2 Move shelf to the left to free its right ends from holes in the cabinet wall.
- 3 Lower right side of shelf, move shelf to the right and take it out.

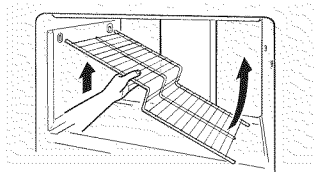

To replace the step shelf:

- 1 With shelf tilted as shown, fit left ends of shelf into holes in cabinet wall.
- 2 Lift left side of shelf slightly, swing shelf up, fit right ends of shelf into holes in cabinet wall, and lower shelf into place.

About the storage drawers.

Not all features are on all models.

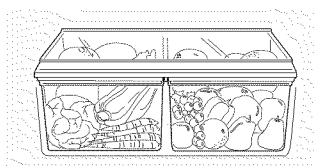

Fruit and Vegetable Drawers

Excess water that may accumulate in the bottom of the drawers should be emptied and the drawers wiped dry.

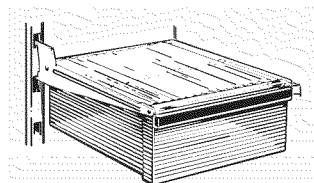

Snacks Drawer

The snacks drawer can be moved to the most useful location for your family's needs.

About storage drawer and cover removal.

Not all features are on all models.

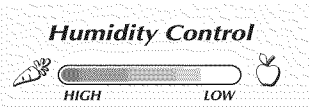

Adjustable Humidity Drawer (on some models)

Slide the control all the way to the HIGH setting to provide high humidity recommended for most vegetables.

Slide the control all the way to the LOW setting to provide lower humidity levels recommended for most fruits.

Drawer and Cover Removal

Drawers can be removed easily by grasping the sides and lifting up slightly while pulling drawers past the **stop** location.

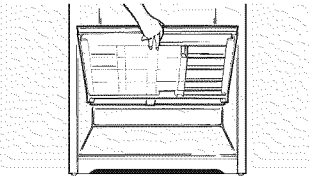

Full-Width Drawer with Plastic Cover

To remove the cover, lift it off its supports, pull it forward, tilt it and take it out.

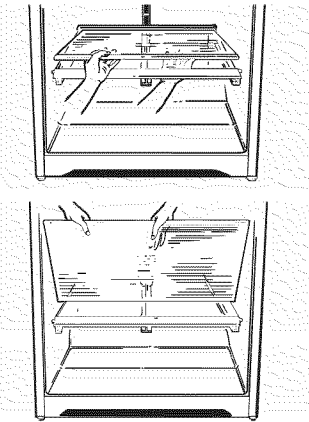

Twin Drawer Shelf

To remove:

- 1 Remove the drawers.
 - 2 Reach in, push the front of glass cover up, and at the same time, pull it forward as far as it will come.
- Tilt it and take it out. Avoid cleaning the cold glass cover with hot water because the extreme temperature difference may cause it to break.
- 3 Remove the drawer frame. (Always remove the glass cover before you take out the drawer frame.)

To replace:

- 1 Lower the frame until it rests on the supports at each side and back.
- 2 Replace the glass cover, pushing its rear edge firmly into the rear frame channel and gently lowering the front into place.
- 3 Replace the drawers.

Lift the frame off the supports at each side and back, pull it forward, tilt it and take it out.

About the automatic icemaker.

A newly-installed refrigerator may take 12 to 24 hours to begin making ice.

There are 2 types of icemakers:

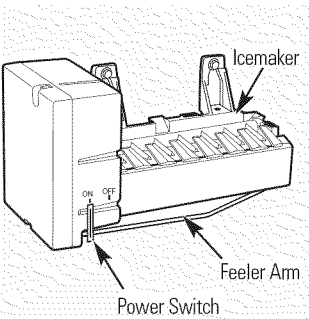

Power switch model

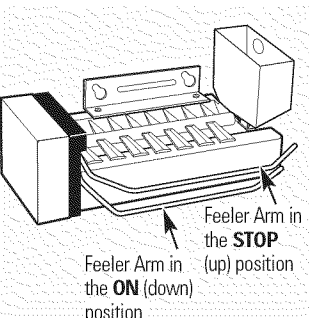

Feeler arm model

Automatic Icemaker (on some models)

The icemaker will produce approximately 70-100 cubes in a 24-hour period, depending on the freezer compartment temperature, room temperature, number of door openings and other use conditions.

If the refrigerator is operated before the water connection is made to the icemaker, set the switch to **OFF** or move the feeler arm to the **STOP** (up) position.

When the refrigerator has been connected to the water supply, set the switch to the **ON** position or move the feeler arm to the **ON** (down) position.

The icemaker will fill with water when it cools to 15°F. A newly-installed refrigerator may take 12 to 24 hours to begin making ice cubes.

Once the icemaker starts to make ice, it may take up to 48 hours to fill the bin, depending on the temperature settings and number of door openings.

You will hear a buzzing sound each time the icemaker fills with water.

Throw away the first few batches of ice to allow the water line to clear.

Be sure nothing interferes with the sweep of the feeler arm.

When the bin fills to the level of the feeler arm, the icemaker will stop producing ice.

It is normal for several cubes to be joined together.

If ice is not used frequently, old ice cubes will become cloudy, taste stale, shrink or fuse together.

Icemaker Accessory Kit

If your refrigerator did not already come equipped with an automatic icemaker, an icemaker accessory kit is available at extra cost.

Check the back of the refrigerator for the specific icemaker kit needed for your model.

Care and cleaning of the refrigerator.

Cleaning the Outside

The door handles and trim (on some models). Clean with a cloth dampened with soapy water. Dry with a soft cloth.

Keep the outside clean. Wipe with a clean cloth lightly dampened with kitchen appliance wax or mild liquid dish detergent. Dry and polish with a clean, soft cloth.

The stainless steel panels and door handles (on some models) can be cleaned with a commercially available stainless steel cleaner. Do not use appliance wax or polish on the stainless steel.

Do not wipe the refrigerator with a soiled dish cloth or wet towel. These may leave a residue that can erode the paint. Do not use scouring pads, powdered cleaners, bleach or cleaners containing bleach because these products can scratch and weaken the paint finish.

Cleaning the Inside

To help prevent odors, leave an open box of baking soda in the fresh food and freezer compartments.

Unplug the refrigerator before cleaning. If this is not practical, wring excess moisture out of sponge or cloth when cleaning around switches, lights or controls.

Use warm water and baking soda solution—about a tablespoon (15 ml) of baking soda to a quart (1 liter) of water. This both cleans and neutralizes odors. Rinse and wipe dry.

After cleaning the door gaskets, apply a thin layer of petroleum jelly to the door gaskets at the hinge side. This helps keep the gaskets from sticking and bending out of shape.

Avoid cleaning cold glass shelves (on some models) with hot water because the extreme temperature difference may cause them to break. Handle glass shelves carefully. Bumping tempered glass can cause it to shatter.

Do not wash any plastic refrigerator parts in the dishwasher.

Condenser

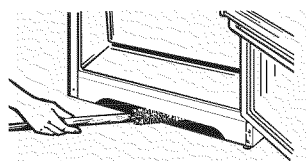

Cleaning the condenser coils.

There is no need for routine condenser cleaning in normal home operating environments. However, in environments that may be particularly dusty or greasy, the condenser should be

cleaned periodically for efficient refrigerator operation.

To clean the condenser, turn the temperature control dial to **OFF**. Sweep away or vacuum up dust.

For best results, use a brush specially designed for this purpose. It is available at most appliance parts stores.

Moving the Refrigerator

Be careful when moving the refrigerator away from the wall. All types of floor coverings can be damaged, particularly cushioned coverings and those with embossed surfaces.

Turn the leveling legs at each front corner of the refrigerator counterclockwise until the rollers support the refrigerator. Pull the refrigerator straight out and return it to position by pushing it straight in. Moving the refrigerator in a side direction may result in damage to the floor covering or refrigerator.

When pushing the refrigerator back, make sure you don't roll over the power cord or icemaker supply line (on some models).

After rolling the refrigerator back into place, turn the legs clockwise until the legs again bear the weight of the refrigerator.

Light Bulb Replacement

To replace a burned-out bulb, unplug the refrigerator from its electrical outlet, unscrew the bulb when cool and replace it with an appliance bulb of the same or lower wattage.

Turning the control to the **OFF** position does not remove power to the light circuit.

Preparing for Vacation

For long vacations or absences, remove food and unplug the refrigerator. Move the temperature control dial to the **OFF** position, and clean the interior with a baking soda solution of one tablespoon (15 ml) of baking soda to one quart (1 liter) of water. Leave the doors open.

Move the feeler arm to the **STOP** (up) position, or move the switch to the **OFF** position on the slide switch model and shut off the water supply to the refrigerator.

If the temperature can drop below freezing, have a qualified servicer drain the water supply system (on some models) to prevent serious property damage due to flooding.

Preparing to Move

Secure all loose items such as grille, shelves and drawers by taping them securely in place to prevent damage. Be sure the refrigerator stays in an upright position during moving.

Installation Instructions *Models 16, 17, 18*

If you have questions, call 1.800.GE.CARES or visit our Website at: GEAppliances.com
In Canada, call 1.800.561.3344 or Visit our Website at: www.geappliances.ca

BEFORE YOU BEGIN

Read these instructions completely and carefully.

- **IMPORTANT** – Save these instructions for local inspector's use.
- **IMPORTANT** – Observe all governing codes and ordinances.
- **Note to Installer** – Be sure to leave these instructions with the Consumer.
- **Note to Consumer** – Keep these instructions for future reference.
- **Skill level** – Installation of this appliance requires basic mechanical skills.
- **Completion time** – Refrigerator Installation
15 minutes
Reversing the Door Swing
1 hour
- Proper installation is the responsibility of the installer.
- Product failure due to improper installation is not covered under the Warranty.

WATER SUPPLY TO THE ICEMAKER (on some models)

If the refrigerator has an icemaker, it will have to be connected to a cold water line. A water supply kit (containing copper tubing, shutoff valve, fittings and instructions) is available at extra cost from your dealer, by visiting our Website at GEAppliances.com (in Canada at www.geappliances.ca) or from Parts and Accessories, 1.800.661.1616.

REFRIGERATOR LOCATION

- Do not install the refrigerator where the temperature will go below 60°F (16°C) because it will not run often enough to maintain proper temperatures.
- Install it on a floor strong enough to support it fully loaded.

CLEARANCES

Allow the following clearances for ease of installation, proper air circulation and plumbing and electrical connections.

- Sides 3/4" (19 mm)
- Top 1" (25 mm)
- Back 2" (50 mm)

ROLLERS AND LEVELING LEGS

Leveling legs near each front corner of the refrigerator are adjustable. They firmly position the refrigerator and prevent it from moving when the doors are opened. Leveling legs should be set so the front of the refrigerator is raised just enough that the doors close easily when opened about halfway.

Turn the leveling legs **clockwise to raise** the refrigerator, **counterclockwise to lower it**.

Rollers next to the leveling legs allow you to move the refrigerator away from the wall for cleaning.

Turn the legs counterclockwise until the weight of the refrigerator is transferred from them to the rollers. After rolling the refrigerator back into place, turn the legs clockwise until the legs again bear the weight of the refrigerator.

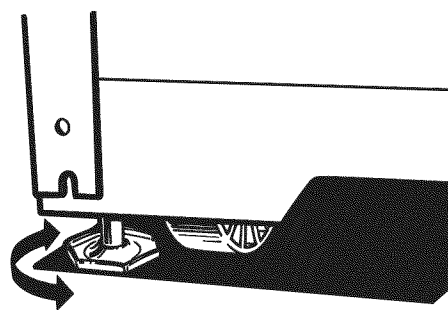

Installation Instructions

1 INSTALLING THE WATER LINE (ON SOME MODELS)

BEFORE YOU BEGIN

Recommended copper water supply kits are WX8X2, WX8X3 or WX8X4, depending on the amount of tubing you need. Approved plastic water supply lines are GE SmartConnect™ Refrigerator Tubing (WX08X10006, WX08X10015 and WX08X10025).

When connecting your refrigerator to a GE Reverse Osmosis Water System, the only approved installation is with a GE RVKit. For other reverse osmosis water systems, follow the manufacturer's recommendations.

This water line installation is not warranted by the refrigerator or icemaker manufacturer. Follow these instructions carefully to minimize the risk of expensive water damage.

Water hammer (water banging in the pipes) in house plumbing can cause damage to refrigerator parts and lead to water leakage or flooding. Call a qualified plumber to correct water hammer before installing the water supply line to the refrigerator.

To prevent burns and product damage, do not hook up the water line to the hot water line.

If you use your refrigerator before connecting the water line, make sure the switch is set to **OFF** or the feeler arm in the **STOP** (up) position.

Do not install the icemaker tubing in areas where temperatures fall below freezing.

When using any electrical device (such as a power drill) during installation, be sure the device is double insulated or grounded in a manner to prevent the hazard of electric shock, or is battery powered.

All installations must be in accordance with local plumbing code requirements.

WHAT YOU WILL NEED

- **Copper or GE SmartConnect™ Refrigerator Tubing kit**, 1/4" outer diameter to connect the refrigerator to the water supply. If using copper, be sure both ends of the tubing are cut square.

To determine how much tubing you need: measure the distance from the water valve on the back of the refrigerator to the water supply pipe. Then add 8' (2.4 m). Be sure there is sufficient extra tubing (about 8' [2.4 m] coiled into 3 turns of about 10" [25 cm] diameter) to allow the refrigerator to move out from the wall after installation.

WHAT YOU WILL NEED (CONT.)

GE SmartConnect™ Refrigerator Tubing Kits are available in the following lengths:

- 6' (1.8 m) – WX08X10006
- 15' (4.6 m) – WX08X10015
- 25' (7.6 m) – WX08X10025

Be sure that the kit you select allows at least 8' (2.4 m) as described above.

NOTE: The only GE approved plastic tubing is that supplied in GE SmartConnect™ Refrigerator Tubing kits. Do not use any other plastic water supply line because the line is under pressure at all times. Certain types of plastic will crack or rupture with age and cause water damage to your home.

- **A GE water supply kit** (containing tubing, shutoff valve and fittings listed below) is available at extra cost from your dealer or from Parts and Accessories, 1.800.661.1616.
- **A cold water supply.** The water pressure must be between 20 and 120 p.s.i. (1.4–8.1 bar).
- **Power drill.**
- **1/2" or adjustable wrench.**
- **Straight and Phillips blade screwdriver.**
- **Two 1/4" outer diameter compression nuts and 2 ferrules (sleeves)**—to connect the copper tubing to the shutoff valve and the refrigerator water valve.

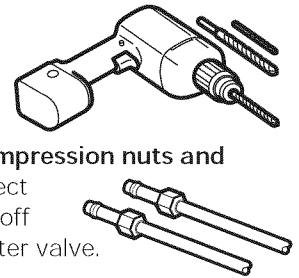

OR

- If you are using a GE SmartConnect™ Refrigerator Tubing kit, the necessary fittings are preassembled to the tubing.
- If your existing copper water line has a flared fitting at the end, you will need an **adapter** (available at plumbing supply stores) to connect the water line to the refrigerator **OR** you can cut off the flared fitting with a **tube cutter** and then use a compression fitting. Do not cut formed end from GE SmartConnect™ Refrigerator tubing.

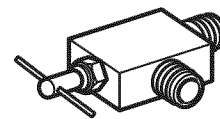

- **Shutoff valve** to connect to the cold water line. The shutoff valve should have a water inlet with a minimum inside diameter of 5/32" at the point of connection to the **COLD WATER LINE**. Saddle-type shutoff valves are included in many water supply kits. Before purchasing, make sure a saddle-type valve complies with your local plumbing codes.

Installation Instructions

Install the shutoff valve on the nearest frequently used drinking water line.

1 SHUT OFF THE MAIN WATER SUPPLY AND UNPLUG REFRIGERATOR

Turn on the nearest faucet (counterclockwise) long enough to clear the line of water.

2 DRILL THE HOLE FOR THE VALVE

Choose a location for the valve that is easily accessible. It is best to connect into the side of a vertical water pipe. When it is necessary to connect into a horizontal water pipe, make the connection to the top or side, rather than at the bottom, to avoid drawing off any sediment from the water pipe.

Drill a 1/4" hole in the water pipe (even if using a self-piercing valve), using a sharp bit. Remove any burrs resulting from drilling the hole in the pipe. **Take care not to allow water to drain into the drill.** Failure to drill a 1/4" hole may result in reduced ice production or smaller cubes.

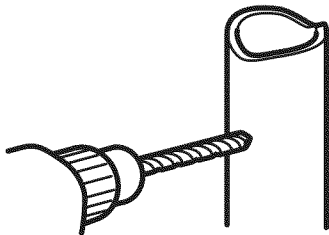

3 FASTEN THE SHUTOFF VALVE

Fasten the shutoff valve to the cold water pipe with the pipe clamp.

Tighten the clamp screws until the sealing washer begins to swell.

NOTE: Do not overtighten or you may crush the tubing.

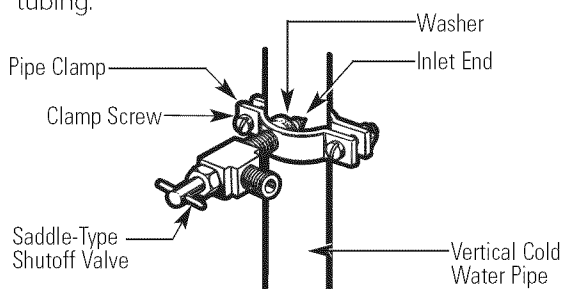

NOTE: Commonwealth of Massachusetts Plumbing Codes 248CMR shall be adhered to. Saddle valves are illegal and use is not permitted in Massachusetts. Consult with your licensed plumber.

4 ROUTE THE TUBING

Route the tubing between the cold water line and the refrigerator.

Route the tubing through a hole drilled in the wall or floor (behind the refrigerator or adjacent base cabinet) as close to the wall as possible.

NOTE: Be sure there is sufficient extra tubing (about 8 feet [244 cm] coiled into 3 turns of about 10" [25 cm] diameter) to allow the refrigerator to move out from the wall after installation.

5 CONNECT THE TUBING TO THE VALVE

Place the compression nut and ferrule (sleeve) for copper tubing onto the end of the tubing and connect it to the shutoff valve.

Make sure the tubing is fully inserted into the valve. Tighten the compression nut securely.

For plastic tubing from a GE SmartConnect™ Refrigerator Tubing kit, insert the molded end of the tubing into the shutoff valve and tighten compression nut until it is hand tight, then tighten one additional turn with a wrench. Overtightening may cause leaks.

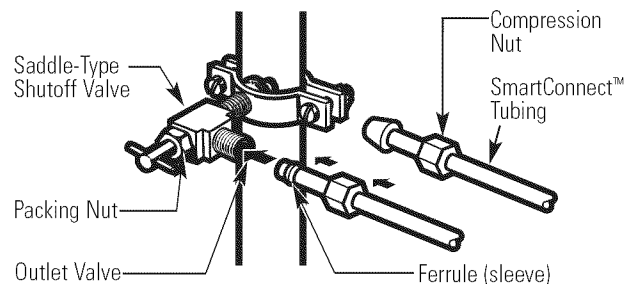

NOTE: Commonwealth of Massachusetts Plumbing Codes 248CMR shall be adhered to. Saddle valves are illegal and use is not permitted in Massachusetts. Consult with your licensed plumber.

6 FLUSH OUT THE TUBING

Turn the main water supply on (counterclockwise) and flush out the tubing until the water is clear.

Shut the water off at the water valve after about one quart (1 liter) of water has been flushed through the tubing.

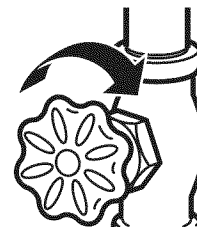

Installation Instructions

1 INSTALLING THE WATER LINE (CONT.)

7 CONNECT THE TUBING TO THE REFRIGERATOR

NOTES:

- Before making the connection to the refrigerator, be sure the refrigerator power cord is not plugged into the wall outlet.
- We recommend installing a water filter if your water supply has sand or particles that could clog the screen of the refrigerator's water valve. Install it in the water line near the refrigerator. If using GE SmartConnect™ Refrigerator Tubing kit, you will need an additional tube (WX08X10002) to connect the filter. Do not cut plastic tube to install filter.

Remove the access cover.

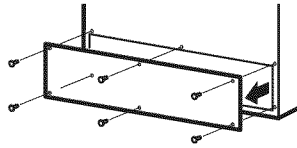

Remove the plastic flexible cap from the water valve (refrigerator connection).

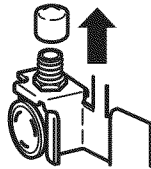

Place the compression nut and ferrule (sleeve) onto the end of the tubing as shown. On GE SmartConnect™ Refrigerator Tubing kit, the nuts are already assembled to the tubing.

Insert the end of the tubing into the water valve connection as far as possible. While holding the tubing, tighten the fitting.

For plastic tubing from a GE SmartConnect™ Refrigerator Tubing kit, insert the molded end of the tubing into the shutoff valve and tighten compression nut until it is hand tight, then tighten one additional turn with a wrench. Overtightening may cause leaks.

Fasten the tubing into the clamp provided to hold it in a vertical position. You may need to pry open the clamp.

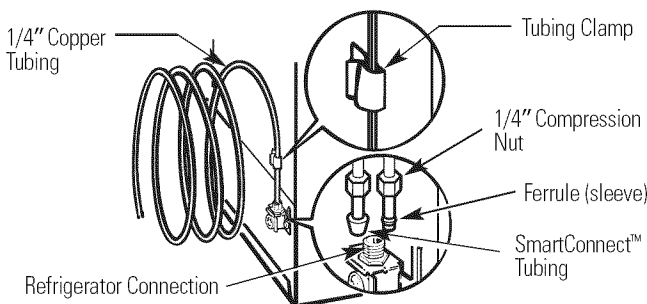

Reattach the access cover.

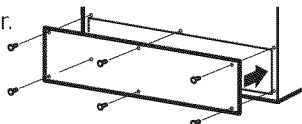

8 TURN THE WATER ON AT THE SHUTOFF VALVE

Tighten any connections that leak.

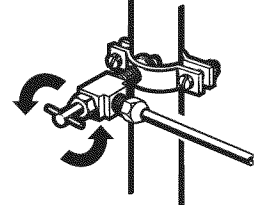

9 PLUG IN THE REFRIGERATOR

Arrange the coil of tubing so that it does not vibrate against the back of the refrigerator or against the wall. Push the refrigerator back to the wall.

10 START THE ICEMAKER

On power switch models, set the icemaker power switch to the **ON** position. On feeler arm models, move the feeler arm to the **ON** (down) position. The icemaker will not begin to operate until it reaches its operating temperature of 15°F (-9°C) or below. It will then begin operation automatically.

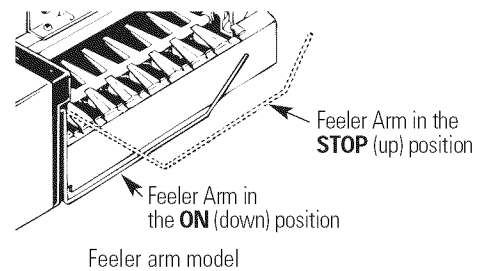
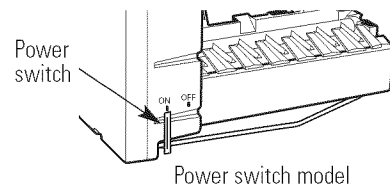

NOTE: In lower water pressure conditions, the water valve may turn on up to 3 times to deliver enough water to the icemaker.

Installation Instructions

2 REVERSING THE DOOR SWING

IMPORTANT NOTES

When reversing the door swing:

- Read the instructions all the way through before starting.
- Handle parts carefully to avoid scratching paint.
- Set screws down by their related parts to avoid using them in the wrong places.
- Provide a non-scratching work surface for the doors.

IMPORTANT: Once you begin, do not move the cabinet until door-swing reversal is completed.

These instructions are for changing the hinges from the right side to the left side—if you ever want to change the hinges back to the right side, follow these same instructions and reverse all references to left and right.

TOOLS REQUIRED

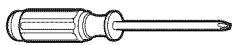

Phillips screwdriver

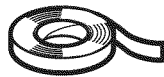

Masking tape



5/16" hex-head socket driver



T20 or T25 Torxdriver (needed for some models)



Putty knife or thin-blade screwdriver



5/16" open-end wrench

1 BEFORE YOU START

1.1 Unplug the refrigerator from its electrical outlet.

1.2 Empty all door shelves, including the dairy compartment.

CAUTION: Do not let either door drop to the floor. To do so could damage the door stop.

2 REMOVE THE FREEZER DOOR

2.1 Tape the door shut with masking tape.

2.2 With a 5/16" hex-head socket driver, remove the screws that hold the top hinge to the cabinet.

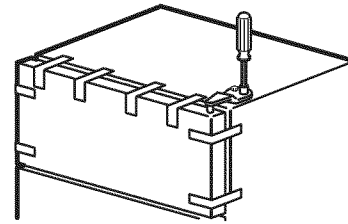

2.3 Lift the hinge straight up to free the hinge pin from the socket in the top of the door and set it aside, along with its screws.

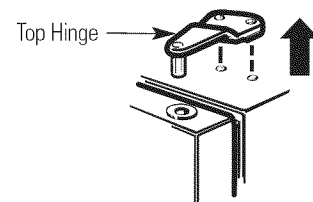

2.4 Remove the tape and tilt the door away from the cabinet. Lift it off the center hinge pin.

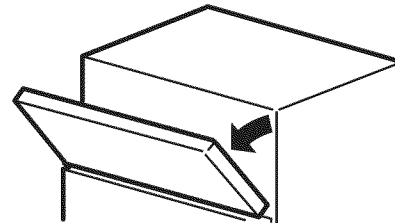

2.5 Set the door on a non-scratching surface with the outside up.

2.6 Transfer the 2 screws from the opposite side of the cabinet to the screw holes vacated by the top hinge removal.

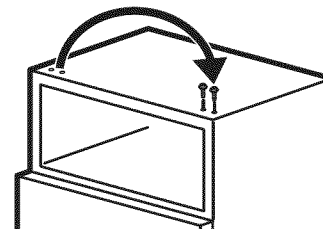

Installation Instructions

2 REVERSING THE DOOR SWING (CONT.)

3 REMOVE THE FRESH FOOD DOOR

3.1 Tape the door shut with masking tape.

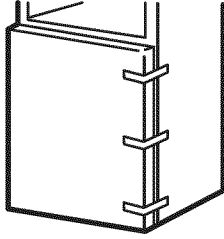

3.2 Using a 5/16" hex-head socket screwdriver and a 5/16" open-end wrench, remove the two screws holding the center hinge to the cabinet. Lift the center hinge to free its pin from the socket in the top of the door, and set hinge and screws aside. **Be careful not to lose the center hinge spacer and washer.**

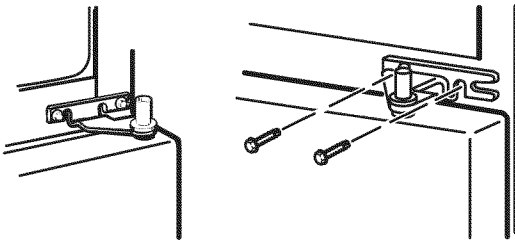

3.3 Remove the tape and tilt the door away from the cabinet. Lift the door from the pin in the bottom hinge bracket. (If the plastic washer sticks to the door bottom, put it back on the hinge.)

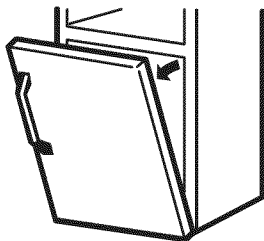

3.4 Set the door outside-up on a non-scratching surface.

3 REMOVE THE FRESH FOOD DOOR (CONT.)

3.5 Transfer the two screws from the opposite side of the cabinet to the screw holes vacated by the center hinge removal.

3.6 Transfer the washer (if your model has one) to the opposite side.

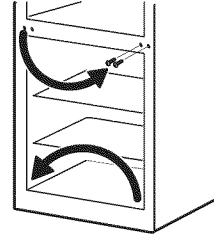

3.7 Take one of the screws removed in step 2 and start it in the outermost screw hole on the opposite side. Do not drive it all the way down—leave enough space under the screw head for thickness of the bracket.

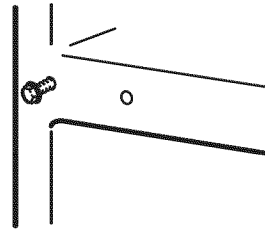

4 REVERSING THE HARDWARE

4.1 Move the bottom hinge bracket and plastic washer from the right side to the left side.

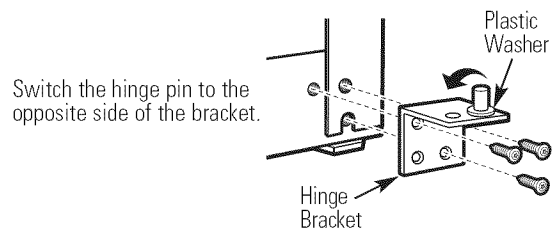

Installation Instructions

4 REVERSING THE HARDWARE (CONT.)

4.2 Interchange hinge and screws at top right with screws at top left of cabinet. **Do not tighten screws on hinge side at this time.**

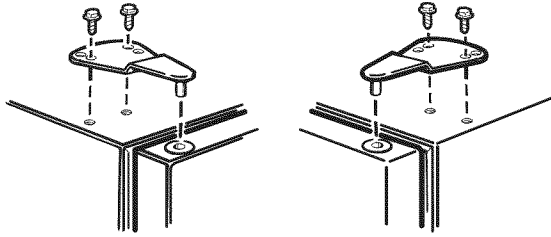

Installing the hinge on the left. Installing the hinge on the right.

NOTES:

- Some hinges have four holes. Which holes you use for installing the hinge depends on which side you install the hinge.
- The outer edge of the hinge should be parallel to the edge of the case for correct installation.

5 REVERSING THE DOOR HANDLES

5.1 Transfer fresh food door handle

5.1.1 Remove the handle plug using a tape-tipped putty knife under the edge, and remove the screw underneath. Remove the two screws holding the handle to the top of the door.

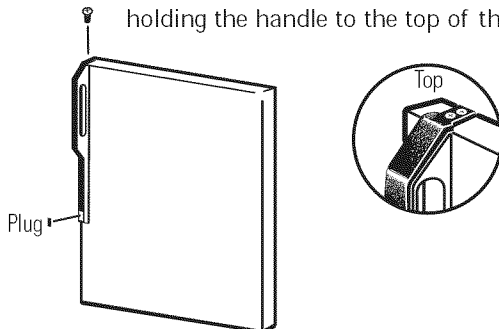

5.1.2 Remove the handle.

5 REVERSING THE DOOR HANDLES (CONT.)

5.1.3 Remove plug button from the top hinge hole on the left side of the door and insert it into the hole on the opposite side that was vacated by removal of the top hinge.

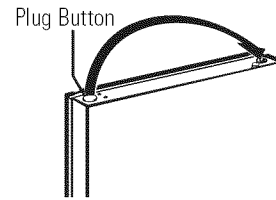

5.1.4 Pull the plug button from the front of the door and transfer it to the opposite side.

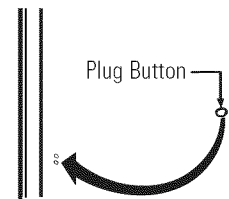

To reattach the handle on the opposite side.

5.2 Transfer door stop

5.2.1 Move the plastic door stop and screws from the right side to the left side.

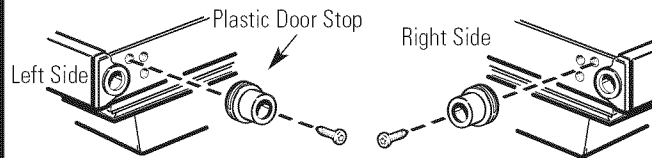

5.2.2 Move the metal door stop from the right side to the left side and transfer the screw to the opposite side of the door.

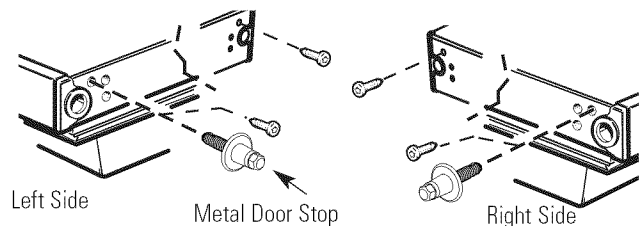

5.3 Reinstall the fresh food door handle

5.3.1 Attach the handle to the right side of the door with screws at the top and under the handle plug.

5.3.2 Reinstall the handle plug.

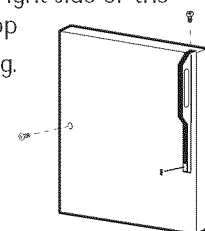

Installation Instructions

2 REVERSING THE DOOR SWING (CONT.)

5 REVERSING THE DOOR HANDLES (CONT.)

5.4 Transfer Freezer Door Handle

5.4.1 Remove the screw holding the handle to the top of the door and the two screws holding the handle to the bottom of the door.

5.4.2 Remove the handle.

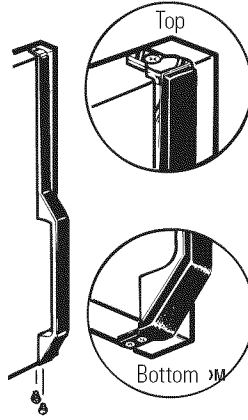

5.4.3 Remove the screw from the right top edge of the door and insert it into the handle screw hole on the left side.

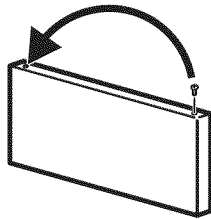

5.4.4 Transfer the door stop as shown in preceding section 5.2.

5.4.5 Attach the handle to the right edge of the door with screws at top and bottom, using bottom holes vacated by removal of the door stop screws.

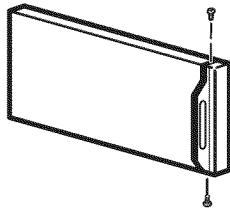

6 RE-HANGING THE DOORS

6.1 Re-hang the fresh food door

6.1.1 Lower the fresh food door onto the bottom hinge pin. **Be sure the washer is in place on the pin.**

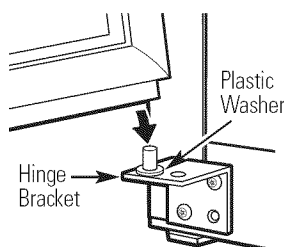

6 RE-HANGING THE DOORS (CONT.)

6.1.2 Insert the pin on the center hinge into the socket in the top of the door. Place the spacer, then the washer, on the hinge pin.

NOTE: The center hinge must be turned over as shown when mounted on the left side.

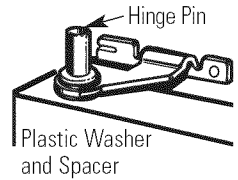

6.1.3 Tilt the door toward the cabinet. As the door is brought into position, slide the hinge under the head of the screw which earlier had been partly driven into the outermost hole. Insert the remaining screw, then tighten both screws securely.

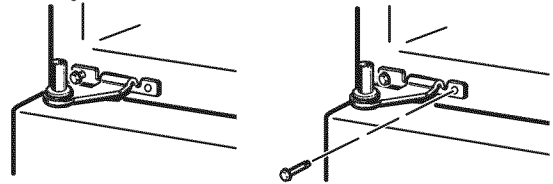

6.2 Re-hang the freezer door

6.2.1 Lower the freezer door onto the center hinge pin. **Be sure the washer and spacer are in place on the pin.**

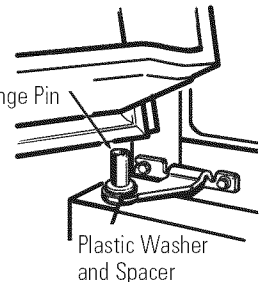

6.2.2 Tilt the door toward the cabinet, lifting the top hinge so the pin fits into the socket on the top of the door.

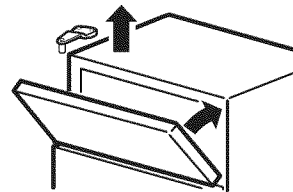

6.2.3 Make sure the door is slightly above the top of the cabinet and the gap between the doors is even across the front. Tighten the top hinge screws. Do not overtighten these screws—tighten them until they are just snug, then turn them another one-half turn.

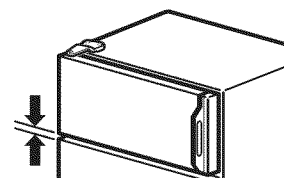



Newer refrigerators sound different from older refrigerators. Modern refrigerators have more features and use newer technology.

Do you hear what I hear? These sounds are normal.

- The new high efficiency compressor may run faster and longer than your old refrigerator and you may hear a high-pitched hum or pulsating sound while it is operating.
- You may hear a whooshing sound when the doors close. This is due to pressure equalizing within the refrigerator.

**HUMMM...
WHOOSH...**

WHIR!



- You may hear the fans spinning at high speeds. This happens when the refrigerator is first plugged in, when the doors are opened frequently or when

a large amount of food is added to the refrigerator or freezer compartments. The fans are helping to maintain the correct temperatures.

CLICKS, POPS, CRACKS and CHIRPS

- You may hear cracking or popping sounds when the refrigerator is first plugged in. This happens as the refrigerator cools to the correct temperature.
- The compressor may cause a clicking or chirping sound when attempting to restart (this could take up to 5 minutes).
- Expansion and contraction of cooling coils during and after defrost can cause a cracking or popping sound.
- On models with an icemaker, after an icemaking cycle, you may hear the ice cubes dropping into the ice bucket.



WATER SOUNDS

- The flow of refrigerant through the freezer cooling coils may make a gurgling noise like boiling water.
- Water dropping on the defrost heater can cause a sizzling, popping or buzzing sound during the defrost cycle.
- A water dripping noise may occur during the defrost cycle as ice melts from the evaporator and flows into the drain pan.
- Closing the door may cause a gurgling sound due to pressure equalization.



For additional information on normal icemaker operating sounds, see the **About the automatic icemaker** section.

Before you call for service...



Troubleshooting Tips
Save time and money! Review the charts on the following pages first and you may not need to call for service.

Problem	Possible Causes	What To Do
Refrigerator does not operate	Refrigerator in defrost cycle.	• Wait about 30 minutes for defrost cycle to end.
	Temperature control dial in OFF position.	• Move the temperature control dial to a temperature setting.
	Refrigerator is unplugged.	• Push the plug completely into the outlet.
	The fuse is blown/circuit breaker is tripped.	• Replace fuse or reset the breaker.
Vibration or rattling (slight vibration is normal)	Roller screws or leveling legs need adjusting.	• See Rollers and Leveling Legs.
Fresh food or freezer compartment too warm	Temperature control dial not set cold enough.	• See About the temperature control dial.
	Warm weather or frequent door openings.	• Set the temperature control dial one step colder. See About the temperature control dial.
	Door left open.	• Check to see if package is holding door open.
	Package blocking air duct in freezer compartment.	• Check to see if package is blocking air duct in freezer compartment.

Before you call for service...



Troubleshooting Tips

Problem	Possible Causes	What To Do
Motor operates for long periods or cycles on and off frequently. (Modern refrigerators with more storage space and a larger space and a larger freezer require more operating time. They start and stop often to maintain even temperatures.)	Normal when refrigerator is first plugged in.	<ul style="list-style-type: none"> • Wait 24 hours for the refrigerator to completely cool down.
	Often occurs when large amounts of food are placed in refrigerator.	<ul style="list-style-type: none"> • This is normal.
	Door left open.	<ul style="list-style-type: none"> • Check to see if package is holding door open.
	Hot weather or frequent door openings.	<ul style="list-style-type: none"> • This is normal.
	Temperature control dial set at the coldest setting.	<ul style="list-style-type: none"> • See About the temperature control dial.
	Grille and condenser need cleaning.	<ul style="list-style-type: none"> • See Care and cleaning.
Frost or ice crystals on frozen food (frost within package is normal)	Door left open.	<ul style="list-style-type: none"> • Check to see if package is holding door open.
	Too frequent or too long door openings.	
Automatic icemaker does not work (on some models)	Icemaker is not on.	<ul style="list-style-type: none"> • Move the feeler arm to the ON (down) position, or move the power switch to the ON position
	Water supply turned off or not connected.	<ul style="list-style-type: none"> • See Installing the water line.
	Freezer compartment too warm.	<ul style="list-style-type: none"> • Wait 24 hours for the refrigerator to completely cool down.
	Piled up cubes in the storage bin cause the icemaker to shut off.	<ul style="list-style-type: none"> • Level cubes by hand.
Frequent "buzzing" sound	Icemaker is on but the water supply to the refrigerator has not been connected	<ul style="list-style-type: none"> • Move the feeler arm to the STOP (up) position, or move the power switch to the OFF position, Keeping it on will damage the water valve..
Cubes too small	Water shutoff valve connecting refrigerator to water line may be clogged.	<ul style="list-style-type: none"> • Call the plumber to clear the valve.
Slow ice cube freezing	Door left open.	<ul style="list-style-type: none"> • Check to see if package is holding door open.
	Temperature control dial not set cold enough.	<ul style="list-style-type: none"> • See About the temperature control dial.
Ice cubes have odor/taste	Ice storage bin needs cleaning.	<ul style="list-style-type: none"> • Empty and wash bin. Discard old cubes.
	Food transmitting odor/taste to ice cubes.	<ul style="list-style-type: none"> • Wrap foods well.
	Interior of refrigerator needs cleaning.	<ul style="list-style-type: none"> • See Care and cleaning.
Moisture forms on cabinet surface between the doors	Not unusual during periods of high humidity.	<ul style="list-style-type: none"> • Wipe surface dry and reset temperature control dial one setting colder.
Moisture collects inside (in humid weather, air carries moisture into refrigerator when doors re opened)	Too frequent or too long door openings.	
Refrigerator has odor	Foods transmitting odor to refrigerator.	<ul style="list-style-type: none"> • Foods with strong odors should be tightly wrapped. • Keep an open box of baking soda in the refrigerator; replace every three months.
	Interior needs cleaning.	<ul style="list-style-type: none"> • See Care and cleaning.

Refrigerator Warranty. (For customers in the United States)

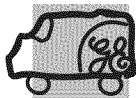

All warranty service provided by our Factory Service Centers, or an authorized Customer Care® technician. To schedule service, on-line, 24 hours a day, visit us at GEAppliances.com, or call 800.GE.CARES (800.432.2737). Please have serial number and model number available when calling for service.

Staple your receipt here. Proof of the original purchase date is needed to obtain service under the warranty.

For The Period Of: GE Will Replace:

GE and GE PROFILE MODELS:

<p>One Year From the date of the original purchase</p>	<p>Any part of the refrigerator which fails due to a defect in materials or workmanship. During this limited one-year warranty, GE will also provide, free of charge, all labor and related service to replace the defective part.</p>
<p>Thirty Days (Water filter, if included) From the original purchase date of the refrigerator</p>	<p>Any part of the water filter cartridge which fails due to a defect in materials or workmanship. During this limited thirty-day warranty, GE will also provide, free of charge, a replacement water filter cartridge.</p>

GE PROFILE MODELS ONLY:

<p>Five Years (GE Profile models only) From the date of the original purchase</p>	<p>Any part of the sealed refrigerating system (the compressor, condenser, evaporator and all connecting tubing) which fails due to a defect in materials or workmanship. During this limited five-year sealed refrigerating system warranty, GE will also provide, free of charge, all labor and related service to replace the defective part in the sealed refrigerating system.</p>
---	---

What GE Will Not Cover:

- Service trips to your home to teach you how to use the product.
- Improper installation, delivery or maintenance.
- Failure of the product if it is abused, misused, or used for other than the intended purpose or used commercially.
- Loss of food due to spoilage.
- Replacement of house fuses or resetting of circuit breakers.
- Damage caused after delivery.
- Products which are not defective, broken or which are working as described in the Owner's manual.
- Replacement of the water filter cartridge, if included, due to water pressure that is outside the specified operating range or due to excessive sediment in the water supply.
- Replacement of the light bulbs, if included, or water filter cartridge, if included, other than as noted above.
- Damage to the product caused by accident, fire, floods or acts of God.
- Incidental or consequential damage caused by possible defects with this appliance.
- Product not accessible to provide required service.

EXCLUSION OF IMPLIED WARRANTIES—Your sole and exclusive remedy is product repair as provided in this Limited Warranty. Any implied warranties, including the implied warranties of merchantability or fitness for a particular purpose, are limited to one year or the shortest period allowed by law.

This warranty is extended to the original purchaser and any succeeding owner for products purchased for home use within the USA. If the product is located in an area where service by a GE Authorized Servicer is not available, you may be responsible for a trip charge or you may be required to bring the product to an Authorized GE Service location for service. In Alaska, the warranty excludes the cost of shipping or service calls to your home.

Some states do not allow the exclusion or limitation of incidental or consequential damages. This warranty gives you specific legal rights, and you may also have other rights which vary from state to state. To know what your legal rights are, consult your local or state consumer affairs office or your state's Attorney General.

Consumer Support.



GE Appliances Website

GEAppliances.com

In the U.S.: **www.Hotpoint.com**

Have a question or need assistance with your appliance? Try the GE Appliances Website 24 hours a day, any day of the year! For greater convenience and faster service, you can now download Owner's Manuals, order parts, or even schedule service on-line. **In Canada: www.geappliances.ca**

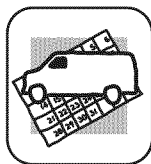

Schedule Service

GEAppliances.com

In the U.S.: **www.Hotpoint.com**

Expert GE repair service is only one step away from your door. Get on-line and schedule your service at your convenience 24 hours any day of the year! Or call 800.GE.CARES (800.432.2737) during normal business hours.

In Canada, call 1.800.561.3344

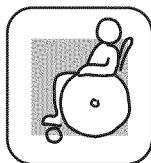

Real Life Design Studio

In the U.S.: **GEAppliances.com**

GE supports the Universal Design concept—products, services and environments that can be used by people of all ages, sizes and capabilities. We recognize the need to design for a wide range of physical and mental abilities and impairments. For details of GE's Universal Design applications, including kitchen design ideas for people with disabilities, check out our Website today. For the hearing impaired, please call 800.TDD.GEAC (800.833.4322).

In Canada, contact: Manager, Consumer Relations, Mabe Canada Inc.
Suite 310, 1 Factory Lane
Moncton, N.B. E1C 9M3



Extended Warranties

In the U.S.: **GEAppliances.com**

Purchase a GE extended warranty and learn about special discounts that are available while your warranty is still in effect. You can purchase it on-line anytime, or call 1.888.261.2133 during normal business hours. GE Consumer Home Services will still be there after your warranty expires.

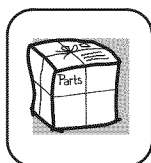

Parts and Accessories

GEAppliances.com

In the U.S.: **www.Hotpoint.com**

Individuals qualified to service their own appliances can have parts or accessories sent directly to their homes (VISA, MasterCard and Discover cards are accepted). Order on-line today, 24 hours every day or by phone at 1.800.661.1616 during normal business hours.

Instructions contained in this manual cover procedures to be performed by any user. Other servicing generally should be referred to qualified service personnel. Caution must be exercised, since improper servicing may cause unsafe operation. Customers **in Canada** should consult the yellow pages for the nearest Mabe service center, or call 1.800.661.1616.



Contact Us

GEAppliances.com

In the U.S.: **www.Hotpoint.com**

If you are not satisfied with the service you receive from GE, contact us on our Website with all the details including your phone number, or write to:

General Manager, Customer Relations
GE Appliances, Appliance Park
Louisville, KY 40225

In Canada: www.geappliances.ca, or write to: Director, Consumer Relations, Mabe Canada Inc.
Suite 310, 1 Factory Lane
Moncton, N.B. E1C 9M3



Register Your Appliance

GEAppliances.com

In the U.S.: **www.Hotpoint.com**

Register your new appliance on-line—at your convenience! Timely product registration will allow for enhanced communication and prompt service under the terms of your warranty, should the need arise. You may also mail in the pre-printed registration card included in the packing material.

In Canada: www.geappliances.ca



Top-Freezer Refrigerators

Safety Instructions 2-4

Operating Instructions

Automatic Icemaker 7
Care and Cleaning 8
Shelves 5, 6
Storage Drawers 6
Temperature Controls 5

Installation Instructions

Preparing to Install
the Refrigerator 9
Reversing the Door Swing 13-16
Water Line Installation 10-12

Troubleshooting Tips

Before You Call For Service 17, 18
Normal Operating Sounds 17

Consumer Support

Consumer Support Back Cover
Refrigerator Warranty 19

**Owner's Manual and
Installation Instructions**

Models 16, 17, 18

**Write the model and serial
numbers here:**

Model # _____

Serial # _____

You can find them on a label on
the upper left side of the fresh food
compartment.

IMPORTANT SAFETY INFORMATION. READ ALL INSTRUCTIONS BEFORE USING.

⚠ DANGER! RISK OF CHILD ENTRAPMENT PROPER DISPOSAL OF THE REFRIGERATOR

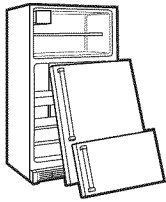

Child entrapment and suffocation are not problems of the past. Junked or abandoned refrigerators are still dangerous...even if they will sit for "just a few days." If you are getting rid of your old refrigerator, please follow the instructions below to help prevent accidents.

Before You Throw Away Your Old Refrigerator or Freezer:

- Take off the doors.
- Leave the shelves in place so that children may not easily climb inside.
- If the refrigerator has a lock make it unusable

Refrigerants

All refrigeration products contain refrigerants, which under federal law must be removed prior to product disposal. If you are getting rid of an old refrigeration product, check with the company handling the disposal about what to do.



USE OF EXTENSION CORDS

Because of potential safety hazards under certain conditions, we strongly recommend against the use of an extension cord.

However, if you must use an extension cord, it is absolutely necessary that it be a UL-listed (in the United States) or a CSA certified (in Canada), 3-wire grounding type appliance extension cord having a grounding type plug and outlet and that the electrical rating of the cord be 15 amperes (minimum) and 120 volts.

⚠ DANGER! RISQUES POUR LES ENFANTS COMMENT VOUS DÉBARRASSER CONVENABLEMENT DE VOTRE ANCIEN RÉFRIGÉRATEUR

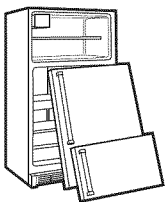

Les enfants pris au piège ou morts d'asphyxie sont toujours d'actualité. Les réfrigérateurs abandonnés sont toujours aussi dangereux, même si on n'attend que «quelques jours» pour s'en débarrasser. Si vous ne gardez pas votre ancien réfrigérateur, veuillez suivre les directives ci-dessous afin de prévenir les accidents.

Avant de vous débarrasser de votre ancien réfrigérateur ou congélateur :

- Démontez les portes.
- Laissez les clayettes en place afin d'empêcher les enfants de grimper à l'intérieur.

Réfrigérants

Tous les appareils de réfrigération contiennent des réfrigérants qui, conformément aux lois fédérales, doivent être enlevés avant toute élimination de l'appareil. Si vous vous débarrassez de vieux appareils de réfrigération, vérifiez, auprès de la société qui s'occupe de leur élimination, ce que vous devez faire.

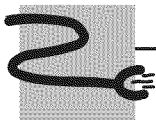

CORDONS PROLONGATEURS

Nous vous recommandons fortement de ne pas utiliser de cordons prolongateurs à cause des risques potentiels qu'ils présentent dans certaines conditions.

Toutefois si vous décidez d'utiliser tout de même un cordon prolongateur, il est absolument nécessaire qu'il s'agisse d'un cordon à 3 fils avec mise à la terre pour appareils électroménagers homologué UL (aux États-Unis) ou certifié CSA (au Canada), pourvu d'une fiche et d'une prise mises à la terre de 15 ampères (minimum) et de 120 volts.

IMPORTANT SAFETY INFORMATION. READ ALL INSTRUCTIONS BEFORE USING.

GEAppliances.com

⚠ WARNING!

Use this appliance only for its intended purpose as described in this Owner's Manual.



SAFETY PRECAUTIONS

When using electrical appliances, basic safety precautions should be followed, including the following:

- This refrigerator must be properly installed and located in accordance with the Installation Instructions before it is used.
- Do not attempt to or allow children to climb, stand or hang on the shelves in the refrigerator. They could damage the refrigerator and seriously injure themselves.
- Do not touch the cold surfaces in the freezer compartment when hands are damp or wet. Skin may stick to these extremely cold surfaces.
- Do not store or use gasoline or other flammable vapors and liquids in the vicinity of this or any other appliance.
- Keep fingers out of the "pinch point" areas; clearances between the doors and between the doors and cabinet are necessarily small. Be careful closing doors when children are in the area.
- Unplug the refrigerator before cleaning and making repairs.
- In refrigerators with automatic icemakers, avoid contact with the moving parts of the ejector mechanism, or with the heating element that releases the cubes. Do not place fingers or hands on the automatic icemaking mechanism while the refrigerator is plugged in.

NOTE: We strongly recommend that any servicing be performed by a qualified individual.
- Turning the temperature control to the **OFF** position does not remove power to the light circuit.
- Do not refreeze frozen foods which have thawed completely.
- Do not allow children to play with refrigerator or tamper with controls.
- **Before replacing a burned-out light bulb, the refrigerator should be unplugged** in order to avoid contact with a live wire filament. (A burned-out light may break when being replaced.)

MESURES DE SÉCURITÉ IMPORTANTES. LISEZ D'ABORD TOUTES LES DIRECTIVES.

⚠ AVERTISSEMENT!

N'utilisez cet électroménager que pour l'usage auquel il est destiné, comme expliqué dans le présent manuel.



MESURES DE SÉCURITÉ

Lorsque vous utilisez un appareil électrique, observez toujours les mesures de sécurité de base, y compris les suivantes.

- Installez le réfrigérateur conformément aux directives d'installation avant de l'utiliser.
- Ne laissez pas les enfants grimper, s'asseoir, se tenir debout ni se pendre aux clayettes du réfrigérateur. Ils pourraient endommager le réfrigérateur et se blesser gravement.
- N'entreposez et n'utilisez pas d'essence ou autres vapeurs et liquides inflammables à proximité de cet appareil ou de tout autre appareil électroménager.
- Éloignez les doigts des parties du réfrigérateur où l'on peut facilement se pincer : les espaces entre les portes et entre les portes et les placards sont toujours étroits. Soyez prudent lorsque vous fermez les portes de l'appareil en présence des enfants.
- Débranchez votre réfrigérateur avant de le nettoyer ou de le réparer.
- Si votre réfrigérateur est doté d'une machine à glaçons automatique évitez le contact avec les pièces mobiles du mécanisme éjecteur, ou avec l'élément chauffant qui libère les glaçons.
Ne posez pas les doigts ou les mains sur le mécanisme de la machine à glaçons pendant que le réfrigérateur est branché.
- Ne touchez pas les surfaces froides du congélateur si vous avez les mains humides ou mouillées : la peau risque d'adhérer à ces surfaces très froides.

REMARQUE : Nous vous recommandons vivement de confier toute réparation à un technicien qualifié.
- Lorsque vous réglez la commande sur 0 (éteint), l'alimentation électrique de l'ampoule n'est pas coupée.
- Ne recongelez pas les aliments surgelés qui ont complètement dégelé.
- Le réfrigérateur doit être débranché avant de remplacer l'ampoule afin d'éviter tout contact avec un fil de câble sous tension.

IMPORTANT SAFETY INFORMATION. READ ALL INSTRUCTIONS BEFORE USING.

⚠ WARNING!

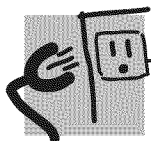

HOW TO CONNECT ELECTRICITY

Do not, under any circumstances, cut or remove the third (ground) prong from the power cord. For personal safety, this appliance must be properly grounded.

The power cord of this appliance is equipped with a 3-prong (grounding) plug which mates with a standard 3-prong (grounding) wall outlet to minimize the possibility of electric shock hazard from this appliance.

Have the wall outlet and circuit checked by a qualified electrician to make sure the outlet is properly grounded.

Where a standard 2-prong wall outlet is encountered, it is your personal responsibility and obligation to have it replaced with a properly grounded 3-prong wall outlet.

The refrigerator should always be plugged into its own individual electrical outlet which has a voltage, wattage and frequency that match the rating plate.

This provides the best performance and also prevents overloading house wiring circuits which could cause a fire hazard from overheated wires.

Never unplug your refrigerator by pulling on the power cord. Always grip plug firmly and pull straight out from the outlet.

Repair or replace immediately all power cords that have become frayed or otherwise damaged. Do not use a cord that shows cracks or abrasion damage along its length or at either end.

When moving the refrigerator away from the wall, be careful not to roll over or damage the power cord.



READ AND FOLLOW THIS SAFETY INFORMATION CAREFULLY.

SAVE THESE INSTRUCTIONS

MESURES DE SÉCURITÉ IMPORTANTES. LISEZ D'ABORD TOUTES LES DIRECTIVES.

⚠ AVERTISSEMENT!

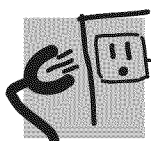

RACCORDEMENT ÉLECTRIQUE

Ne coupez ni retirez en aucun cas la troisième broche (mise à la terre) de la fiche du cordon d'alimentation. Pour votre sécurité, cet appareil doit être correctement mis à la terre.

Le cordon d'alimentation de cet appareil est muni d'une fiche à 3 broches (mise à la terre) qui se branche dans une prise murale ordinaire à 3 alvéoles (mise à la terre) pour réduire au minimum les risques de chocs électriques.

Faites examiner la prise de courant et le circuit par un électricien qualifié pour vous assurer que la prise est correctement mise à la terre.

Si la prise murale est du type standard à 2 alvéoles, il vous incombe de la faire remplacer par une prise à 3 alvéoles correctement mise à la terre.

Le réfrigérateur doit toujours être branché dans sa propre prise de courant, dont la tension nominale est identique à celle indiquée sur la plaque signalétique.

Cette précaution est recommandée pour garantir un rendement optimum et éviter une surcharge des circuits électriques de la résidence, ce qui pourrait créer un risque d'incendie par surchauffe des fils.

Ne débranchez jamais le réfrigérateur en tirant sur le cordon d'alimentation. Saisissez fermement la fiche du cordon et tirez droit pour la retirer de la prise.

Réparez ou remplacez immédiatement tout cordon effiloché ou endommagé. N'utilisez pas un cordon fendillé ou présentant des signes d'usure.

Lorsque vous déplacez votre réfrigérateur du mur, faites attention de ne pas le faire rouler sur le cordon d'alimentation afin de ne pas l'endommager.



VEUILLEZ LIRE ET SUIVRE ATTENTIVEMENT CES MESURES DE SÉCURITÉ. CONSERVEZ CES DIRECTIVES

About the temperature control dial.

Turning the dial to **0/ Off** stops cooling in both compartments—fresh food and freezer. It does not shut off power to the refrigerator.

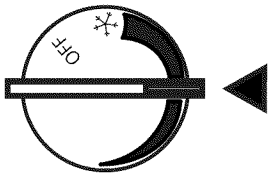

Temperature Control Dial (on some models)

The temperature control dial adjust refrigerator from warmest to coldest. The recommended factory setting is shown in illustration to the left. For colder temperature turn dial clockwise toward snowflake. For warmer temperature turn dial counter clockwise away from snowflake. allow 24 hours for adjustment.

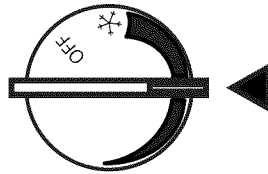

Recommended factory setting

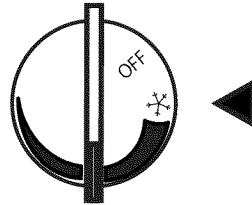

Coldest setting

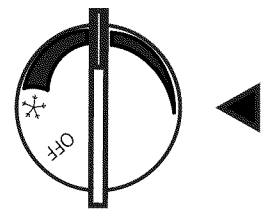

Warmest setting

About the fresh food compartment shelves.

Shelf supports at various levels allow you to custom-space your shelves. Not all features are on all models.

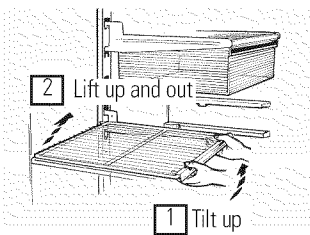

Half-Width Shelves

One end of the shelf rests on a molded side-wall support; a bracket on the other end hooks into a track on the rear cabinet wall. To remove, lift the shelf up at front, then off the support and out of the track. To replace, select desired shelf height. With shelf front raised slightly, hook the bracket's top lug into the track, then lower the shelf onto the support.

NOTE: The shelf to the right of the track is designed to hook into the right-hand slot; the shelf to the left is designed to hook into the left-hand slot.

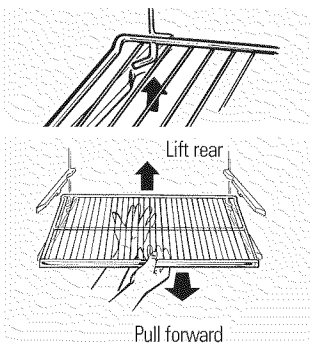
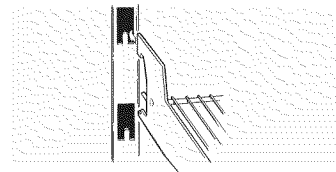

Full-Width Shelves

Some models have a stationary tempered glass shelf, a spillproof shelf, or two steel wire stationary shelves. These shelves can be moved to another place in the fresh food compartment.

When placed correctly on the shelf supports, the shelf will stop before coming completely out of the refrigerator and will not tilt when you place food on it or remove food from it.

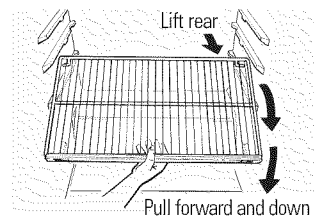

To remove a full-width shelf when the fresh food compartment door cannot be opened fully

To remove the full-width shelves

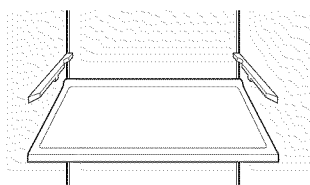

Spillproof Shelves (on some models)

Spillproof shelves have special edges to help prevent spills from dripping to lower shelves. To remove or replace the shelves, see the above instructions.

About the freezer compartment shelves.

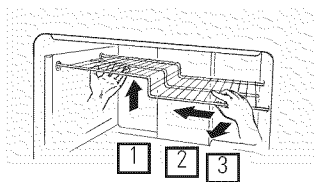

Step Shelf (on some models)

To remove the step shelf:

- 1 Lift left side of shelf slightly.
- 2 Move shelf to the left to free its right ends from holes in the cabinet wall.
- 3 Lower right side of shelf, move shelf to the right and take it out.

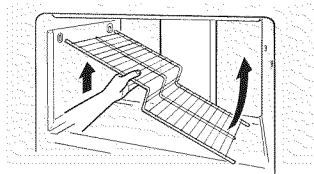

To replace the step shelf:

- 1 With shelf tilted as shown, fit left ends of shelf into holes in cabinet wall.
- 2 Lift left side of shelf slightly, swing shelf up, fit right ends of shelf into holes in cabinet wall, and lower shelf into place.

About the storage drawers.

Not all features are on all models.

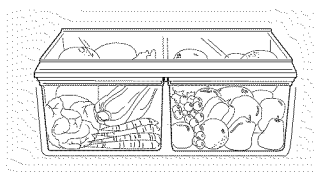

Fruit and Vegetable Drawers

Excess water that may accumulate in the bottom of the drawers should be emptied and the drawers wiped dry.

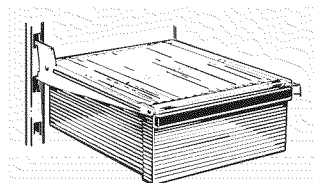

Snacks Drawer

The snacks drawer can be moved to the most useful location for your family's needs.

About storage drawer and cover removal.

Not all features are on all models.

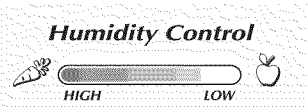

Adjustable Humidity Drawer (on some models)

Slide the control all the way to the HIGH setting to provide high humidity recommended for most vegetables.

Slide the control all the way to the LOW setting to provide lower humidity levels recommended for most fruits.

Drawer and Cover Removal

Drawers can be removed easily by grasping the sides and lifting up slightly while pulling drawers past the **stop** location.

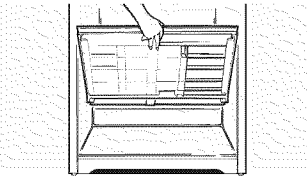

Full-Width Drawer with Plastic Cover

To remove the cover, lift it off its supports, pull it forward, tilt it and take it out.

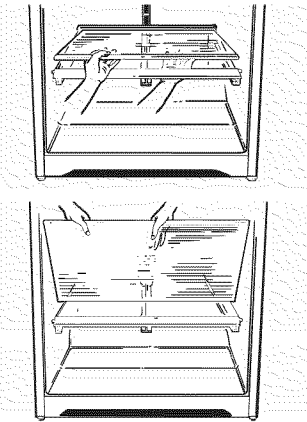

Twin Drawer Shelf

To remove:

- 1 Remove the drawers.
- 2 Reach in, push the front of glass cover up, and at the same time, pull it forward as far as it will come.

Tilt it and take it out. Avoid cleaning the cold glass cover with hot water because the extreme temperature difference may cause it to break.

- 3 Remove the drawer frame. (Always remove the glass cover before you take out the drawer frame.)

Lift the frame off the supports at each side and back, pull it forward, tilt it and take it out.

To replace:

- 1 Lower the frame until it rests on the supports at each side and back.
- 2 Replace the glass cover, pushing its rear edge firmly into the rear frame channel and gently lowering the front into place.
- 3 Replace the drawers.

About the automatic icemaker.

A newly-installed refrigerator may take 12 to 24 hours to begin making ice.

There are 2 types of icemakers:

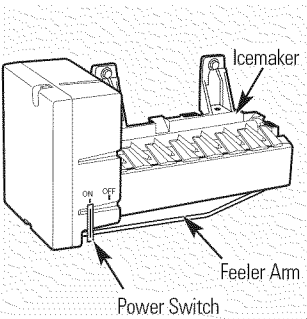

Power switch model

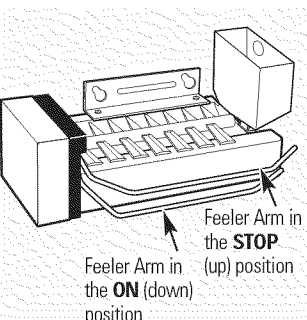

Feeler arm model

Automatic Icemaker (on some models)

The icemaker will produce approximately 70-100 cubes in a 24-hour period, depending on the freezer compartment temperature, room temperature, number of door openings and other use conditions.

If the refrigerator is operated before the water connection is made to the icemaker, set the switch to **OFF** or move the feeler arm to the **STOP** (up) position.

When the refrigerator has been connected to the water supply, set the switch to the **ON** position or move the feeler arm to the **ON** (down) position.

The icemaker will fill with water when it cools to 15°F. A newly-installed refrigerator may take 12 to 24 hours to begin making ice cubes.

Once the icemaker starts to make ice, it may take up to 48 hours to fill the bin, depending on the temperature settings and number of door openings.

You will hear a buzzing sound each time the icemaker fills with water.

Throw away the first few batches of ice to allow the water line to clear.

Be sure nothing interferes with the sweep of the feeler arm.

When the bin fills to the level of the feeler arm, the icemaker will stop producing ice.

It is normal for several cubes to be joined together.

If ice is not used frequently, old ice cubes will become cloudy, taste stale, shrink or fuse together.

Icemaker Accessory Kit

If your refrigerator did not already come equipped with an automatic icemaker, an icemaker accessory kit is available at extra cost.

Check the back of the refrigerator for the specific icemaker kit needed for your model.

Care and cleaning of the refrigerator.

Cleaning the Outside

The door handles and trim (on some models). Clean with a cloth dampened with soapy water. Dry with a soft cloth.

Keep the outside clean. Wipe with a clean cloth lightly dampened with kitchen appliance wax or mild liquid dish detergent. Dry and polish with a clean, soft cloth.

The stainless steel panels and door handles (on some models) can be cleaned with a commercially available stainless steel cleaner. Do not use appliance wax or polish on the stainless steel.

Do not wipe the refrigerator with a soiled dish cloth or wet towel. These may leave a residue that can erode the paint. Do not use scouring pads, powdered cleaners, bleach or cleaners containing bleach because these products can scratch and weaken the paint finish.

Cleaning the Inside

To help prevent odors, leave an open box of baking soda in the fresh food and freezer compartments.

Unplug the refrigerator before cleaning. If this is not practical, wring excess moisture out of sponge or cloth when cleaning around switches, lights or controls.

Use warm water and baking soda solution—about a tablespoon (15 ml) of baking soda to a quart (1 liter) of water. This both cleans and neutralizes odors. Rinse and wipe dry.

After cleaning the door gaskets, apply a thin layer of petroleum jelly to the door gaskets at the hinge side. This helps keep the gaskets from sticking and bending out of shape.

Avoid cleaning cold glass shelves (on some models) with hot water because the extreme temperature difference may cause them to break. Handle glass shelves carefully. Bumping tempered glass can cause it to shatter.

Do not wash any plastic refrigerator parts in the dishwasher.

Condenser

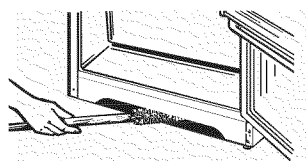

Cleaning the condenser coils.

There is no need for routine condenser cleaning in normal home operating environments. However, in environments that may be particularly dusty or greasy, the condenser should be

cleaned periodically for efficient refrigerator operation.

To clean the condenser, turn the temperature control dial to **OFF**. Sweep away or vacuum up dust.

For best results, use a brush specially designed for this purpose. It is available at most appliance parts stores.

Moving the Refrigerator

Be careful when moving the refrigerator away from the wall. All types of floor coverings can be damaged, particularly cushioned coverings and those with embossed surfaces.

Turn the leveling legs at each front corner of the refrigerator counterclockwise until the rollers support the refrigerator. Pull the refrigerator straight out and return it to position by pushing it straight in. Moving the refrigerator in a side direction may result in damage to the floor covering or refrigerator.

When pushing the refrigerator back, make sure you don't roll over the power cord or icemaker supply line (on some models).

After rolling the refrigerator back into place, turn the legs clockwise until the legs again bear the weight of the refrigerator.

Light Bulb Replacement

To replace a burned-out bulb, unplug the refrigerator from its electrical outlet, unscrew the bulb when cool and replace it with an appliance bulb of the same or lower wattage.

Turning the control to the **OFF** position does not remove power to the light circuit.

Preparing for Vacation

For long vacations or absences, remove food and unplug the refrigerator. Move the temperature control dial to the **OFF** position, and clean the interior with a baking soda solution of one tablespoon (15 ml) of baking soda to one quart (1 liter) of water. Leave the doors open.

Move the feeler arm to the **STOP** (up) position, or move the switch to the **OFF** position on the slide switch model and shut off the water supply to the refrigerator.

If the temperature can drop below freezing, have a qualified servicer drain the water supply system (on some models) to prevent serious property damage due to flooding.

Preparing to Move

Secure all loose items such as grille, shelves and drawers by taping them securely in place to prevent damage. Be sure the refrigerator stays in an upright position during moving.

Installation Instructions *Models 16, 17, 18*

If you have questions, call **1.800.GE.CARES** or visit our Website at: **GEAppliances.com**
In Canada, call **1.800.561.3344** or Visit our Website at: **www.geappliances.ca**

BEFORE YOU BEGIN

Read these instructions completely and carefully.

- **IMPORTANT** – Save these instructions for local inspector's use.
- **IMPORTANT** – Observe all governing codes and ordinances.
- **Note to Installer** – Be sure to leave these instructions with the Consumer.
- **Note to Consumer** – Keep these instructions for future reference.
- **Skill level** – Installation of this appliance requires basic mechanical skills.
- **Completion time** – Refrigerator Installation
15 minutes
Reversing the Door Swing
1 hour
- Proper installation is the responsibility of the installer.
- Product failure due to improper installation is not covered under the Warranty.

WATER SUPPLY TO THE ICEMAKER (on some models)

If the refrigerator has an icemaker, it will have to be connected to a cold water line. A water supply kit (containing copper tubing, shutoff valve, fittings and instructions) is available at extra cost from your dealer, by visiting our Website at **GEAppliances.com** (in Canada at **www.geappliances.ca**) or from Parts and Accessories, 1.800.661.1616.

REFRIGERATOR LOCATION

- Do not install the refrigerator where the temperature will go below 60°F (16°C) because it will not run often enough to maintain proper temperatures.
- Install it on a floor strong enough to support it fully loaded.

CLEARANCES

Allow the following clearances for ease of installation, proper air circulation and plumbing and electrical connections.

- Sides 3/4" (19 mm)
- Top 1" (25 mm)
- Back 2" (50 mm)

ROLLERS AND LEVELING LEGS

Leveling legs near each front corner of the refrigerator are adjustable. They firmly position the refrigerator and prevent it from moving when the doors are opened. Leveling legs should be set so the front of the refrigerator is raised just enough that the doors close easily when opened about halfway.

Turn the leveling legs **clockwise to raise** the refrigerator, **counterclockwise to lower it**.

Rollers next to the leveling legs allow you to move the refrigerator away from the wall for cleaning.

Turn the legs counterclockwise until the weight of the refrigerator is transferred from them to the rollers. After rolling the refrigerator back into place, turn the legs clockwise until the legs again bear the weight of the refrigerator.

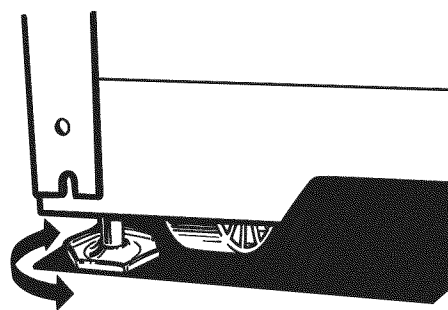

Installation Instructions

1 INSTALLING THE WATER LINE (ON SOME MODELS)

BEFORE YOU BEGIN

Recommended copper water supply kits are WX8X2, WX8X3 or WX8X4, depending on the amount of tubing you need. Approved plastic water supply lines are GE SmartConnect™ Refrigerator Tubing (WX08X10006, WX08X10015 and WX08X10025).

When connecting your refrigerator to a GE Reverse Osmosis Water System, the only approved installation is with a GE RVKit. For other reverse osmosis water systems, follow the manufacturer's recommendations.

This water line installation is not warranted by the refrigerator or icemaker manufacturer. Follow these instructions carefully to minimize the risk of expensive water damage.

Water hammer (water banging in the pipes) in house plumbing can cause damage to refrigerator parts and lead to water leakage or flooding. Call a qualified plumber to correct water hammer before installing the water supply line to the refrigerator.

To prevent burns and product damage, do not hook up the water line to the hot water line.

If you use your refrigerator before connecting the water line, make sure the switch is set to **OFF** or the feeler arm in the **STOP** (up) position.

Do not install the icemaker tubing in areas where temperatures fall below freezing.

When using any electrical device (such as a power drill) during installation, be sure the device is double insulated or grounded in a manner to prevent the hazard of electric shock, or is battery powered.

All installations must be in accordance with local plumbing code requirements.

WHAT YOU WILL NEED

- **Copper or GE SmartConnect™ Refrigerator Tubing kit**, 1/4" outer diameter to connect the refrigerator to the water supply. If using copper, be sure both ends of the tubing are cut square.

To determine how much tubing you need: measure the distance from the water valve on the back of the refrigerator to the water supply pipe. Then add 8' (2.4 m). Be sure there is sufficient extra tubing (about 8' [2.4 m] coiled into 3 turns of about 10" [25 cm] diameter) to allow the refrigerator to move out from the wall after installation.

WHAT YOU WILL NEED (CONT.)

GE SmartConnect™ Refrigerator Tubing Kits are available in the following lengths:

- 6' (1.8 m) – WX08X10006
- 15' (4.6 m) – WX08X10015
- 25' (7.6 m) – WX08X10025

Be sure that the kit you select allows at least 8' (2.4 m) as described above.

NOTE: The only GE approved plastic tubing is that supplied in GE SmartConnect™ Refrigerator Tubing kits. Do not use any other plastic water supply line because the line is under pressure at all times. Certain types of plastic will crack or rupture with age and cause water damage to your home.

- **A GE water supply kit** (containing tubing, shutoff valve and fittings listed below) is available at extra cost from your dealer or from Parts and Accessories, 1.800.661.1616.
- **A cold water supply.** The water pressure must be between 20 and 120 p.s.i. (1.4–8.1 bar).
- **Power drill.**
- **1/2" or adjustable wrench.**
- **Straight and Phillips blade screwdriver.**
- **Two 1/4" outer diameter compression nuts and 2 ferrules (sleeves)**—to connect the copper tubing to the shutoff valve and the refrigerator water valve.

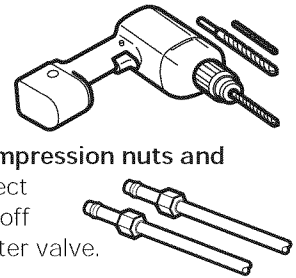

OR

- If you are using a GE SmartConnect™ Refrigerator Tubing kit, the necessary fittings are preassembled to the tubing.
- If your existing copper water line has a flared fitting at the end, you will need an **adapter** (available at plumbing supply stores) to connect the water line to the refrigerator **OR** you can cut off the flared fitting with a **tube cutter** and then use a compression fitting. Do not cut formed end from GE SmartConnect™ Refrigerator tubing.

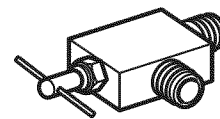

- **Shutoff valve** to connect to the cold water line. The shutoff valve should have a water inlet with a minimum inside diameter of 5/32" at the point of connection to the **COLD WATER LINE**. Saddle-type shutoff valves are included in many water supply kits. Before purchasing, make sure a saddle-type valve complies with your local plumbing codes.

Installation Instructions

Install the shutoff valve on the nearest frequently used drinking water line.

1 SHUT OFF THE MAIN WATER SUPPLY AND UNPLUG REFRIGERATOR

Turn on the nearest faucet (counterclockwise) long enough to clear the line of water.

2 DRILL THE HOLE FOR THE VALVE

Choose a location for the valve that is easily accessible. It is best to connect into the side of a vertical water pipe. When it is necessary to connect into a horizontal water pipe, make the connection to the top or side, rather than at the bottom, to avoid drawing off any sediment from the water pipe.

Drill a 1/4" hole in the water pipe (even if using a self-piercing valve), using a sharp bit. Remove any burrs resulting from drilling the hole in the pipe. **Take care not to allow water to drain into the drill.** Failure to drill a 1/4" hole may result in reduced ice production or smaller cubes.

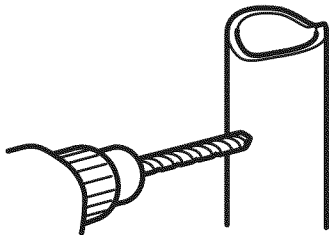

3 FASTEN THE SHUTOFF VALVE

Fasten the shutoff valve to the cold water pipe with the pipe clamp.

Tighten the clamp screws until the sealing washer begins to swell.

NOTE: Do not overtighten or you may crush the tubing.

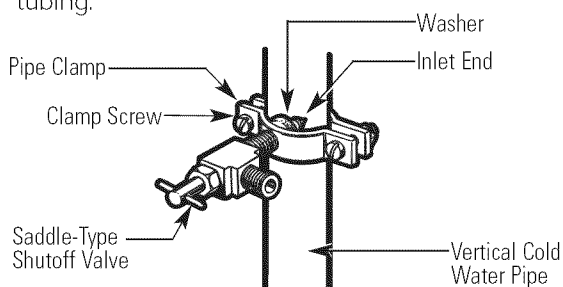

NOTE: Commonwealth of Massachusetts Plumbing Codes 248CMR shall be adhered to. Saddle valves are illegal and use is not permitted in Massachusetts. Consult with your licensed plumber.

4 ROUTE THE TUBING

Route the tubing between the cold water line and the refrigerator.

Route the tubing through a hole drilled in the wall or floor (behind the refrigerator or adjacent base cabinet) as close to the wall as possible.

NOTE: Be sure there is sufficient extra tubing (about 8 feet [244 cm] coiled into 3 turns of about 10" [25 cm] diameter) to allow the refrigerator to move out from the wall after installation.

5 CONNECT THE TUBING TO THE VALVE

Place the compression nut and ferrule (sleeve) for copper tubing onto the end of the tubing and connect it to the shutoff valve.

Make sure the tubing is fully inserted into the valve. Tighten the compression nut securely.

For plastic tubing from a GE SmartConnect™ Refrigerator Tubing kit, insert the molded end of the tubing into the shutoff valve and tighten compression nut until it is hand tight, then tighten one additional turn with a wrench. Overtightening may cause leaks.

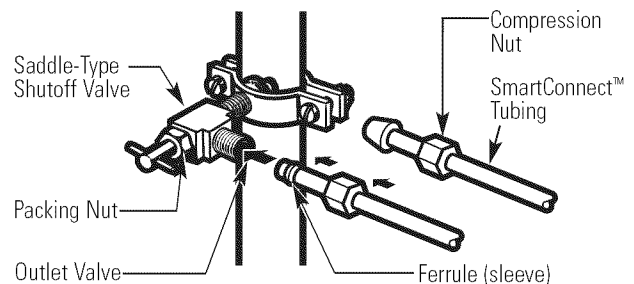

NOTE: Commonwealth of Massachusetts Plumbing Codes 248CMR shall be adhered to. Saddle valves are illegal and use is not permitted in Massachusetts. Consult with your licensed plumber.

6 FLUSH OUT THE TUBING

Turn the main water supply on (counterclockwise) and flush out the tubing until the water is clear.

Shut the water off at the water valve after about one quart (1 liter) of water has been flushed through the tubing.

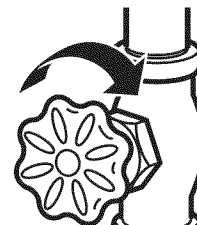

Installation Instructions

1 INSTALLING THE WATER LINE (CONT.)

7 CONNECT THE TUBING TO THE REFRIGERATOR

NOTES:

- Before making the connection to the refrigerator, be sure the refrigerator power cord is not plugged into the wall outlet.
- We recommend installing a water filter if your water supply has sand or particles that could clog the screen of the refrigerator's water valve. Install it in the water line near the refrigerator. If using GE SmartConnect™ Refrigerator Tubing kit, you will need an additional tube (WX08X10002) to connect the filter. Do not cut plastic tube to install filter.

Remove the access cover.

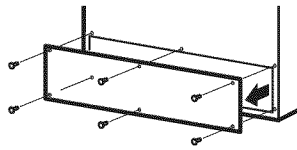

Remove the plastic flexible cap from the water valve (refrigerator connection).

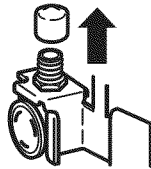

Place the compression nut and ferrule (sleeve) onto the end of the tubing as shown. On GE SmartConnect™ Refrigerator Tubing kit, the nuts are already assembled to the tubing.

Insert the end of the tubing into the water valve connection as far as possible. While holding the tubing, tighten the fitting.

For plastic tubing from a GE SmartConnect™ Refrigerator Tubing kit, insert the molded end of the tubing into the shutoff valve and tighten compression nut until it is hand tight, then tighten one additional turn with a wrench. Overtightening may cause leaks.

Fasten the tubing into the clamp provided to hold it in a vertical position. You may need to pry open the clamp.

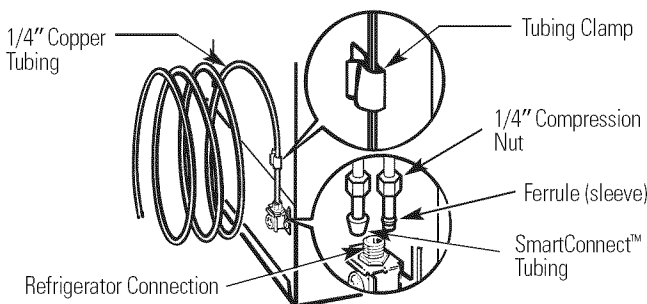

Reattach the access cover.

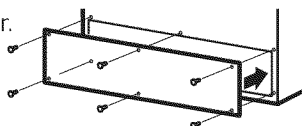

8 TURN THE WATER ON AT THE SHUTOFF VALVE

Tighten any connections that leak.

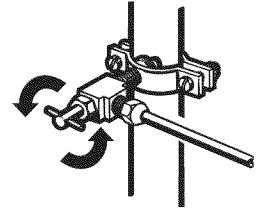

9 PLUG IN THE REFRIGERATOR

Arrange the coil of tubing so that it does not vibrate against the back of the refrigerator or against the wall. Push the refrigerator back to the wall.

10 START THE ICEMAKER

On power switch models, set the icemaker power switch to the **ON** position. On feeler arm models, move the feeler arm to the **ON** (down) position. The icemaker will not begin to operate until it reaches its operating temperature of 15°F (-9°C) or below. It will then begin operation automatically.

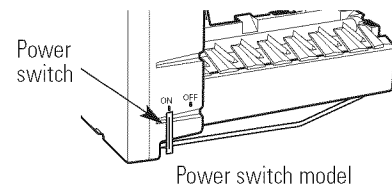

Power switch model

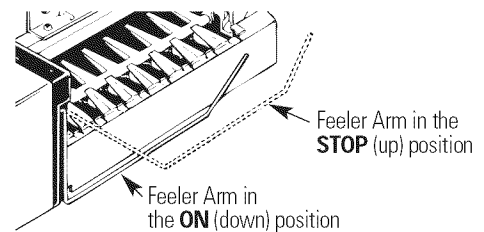

Feeler arm model

NOTE: In lower water pressure conditions, the water valve may turn on up to 3 times to deliver enough water to the icemaker.

Installation Instructions

2 REVERSING THE DOOR SWING

IMPORTANT NOTES

When reversing the door swing:

- Read the instructions all the way through before starting.
- Handle parts carefully to avoid scratching paint.
- Set screws down by their related parts to avoid using them in the wrong places.
- Provide a non-scratching work surface for the doors.

IMPORTANT: Once you begin, do not move the cabinet until door-swing reversal is completed.

These instructions are for changing the hinges from the right side to the left side—if you ever want to change the hinges back to the right side, follow these same instructions and reverse all references to left and right.

TOOLS REQUIRED

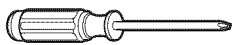

Phillips screwdriver

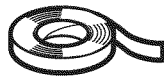

Masking tape



5/16" hex-head socket driver



T20 or T25 Torxdriver (needed for some models)

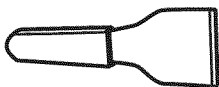

Putty knife or thin-blade screwdriver



5/16" open-end wrench

1 BEFORE YOU START

1.1 Unplug the refrigerator from its electrical outlet.

1.2 Empty all door shelves, including the dairy compartment.

CAUTION: Do not let either door drop to the floor. To do so could damage the door stop.

2 REMOVE THE FREEZER DOOR

2.1 Tape the door shut with masking tape.

2.2 With a 5/16" hex-head socket driver, remove the screws that hold the top hinge to the cabinet.

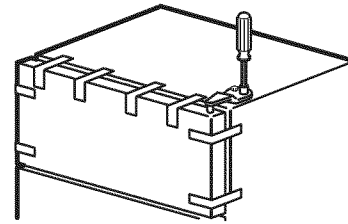

2.3 Lift the hinge straight up to free the hinge pin from the socket in the top of the door and set it aside, along with its screws.

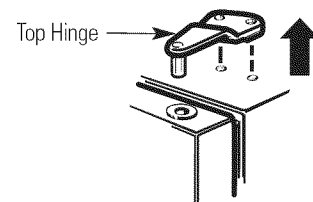

2.4 Remove the tape and tilt the door away from the cabinet. Lift it off the center hinge pin.

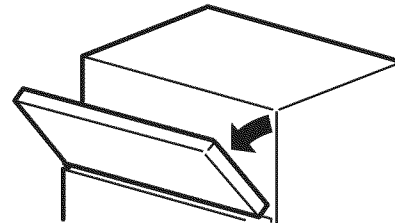

2.5 Set the door on a non-scratching surface with the outside up.

2.6 Transfer the 2 screws from the opposite side of the cabinet to the screw holes vacated by the top hinge removal.

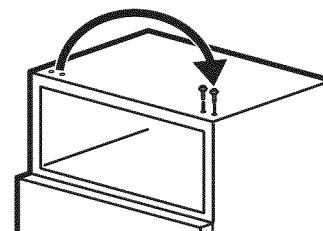

Installation Instructions

2 REVERSING THE DOOR SWING (CONT.)

3 REMOVE THE FRESH FOOD DOOR

3.1 Tape the door shut with masking tape.

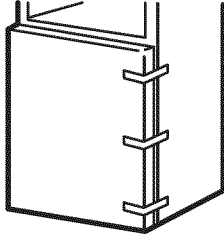

3.2 Using a 5/16" hex-head socket screwdriver and a 5/16" open-end wrench, remove the two screws holding the center hinge to the cabinet. Lift the center hinge to free its pin from the socket in the top of the door, and set hinge and screws aside. **Be careful not to lose the center hinge spacer and washer.**

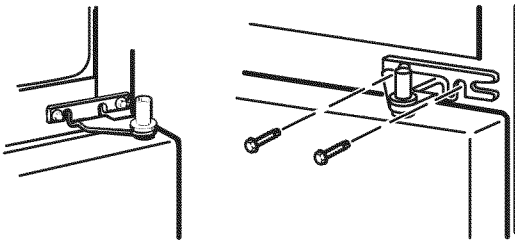

3.3 Remove the tape and tilt the door away from the cabinet. Lift the door from the pin in the bottom hinge bracket. (If the plastic washer sticks to the door bottom, put it back on the hinge.)

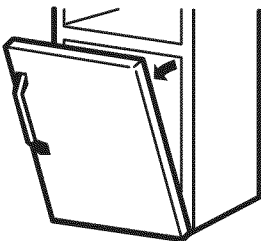

3.4 Set the door outside-up on a non-scratching surface.

3 REMOVE THE FRESH FOOD DOOR (CONT.)

3.5 Transfer the two screws from the opposite side of the cabinet to the screw holes vacated by the center hinge removal.

3.6 Transfer the washer (if your model has one) to the opposite side.

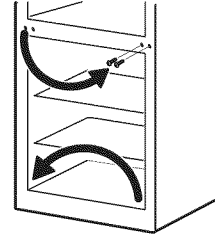

3.7 Take one of the screws removed in step 2 and start it in the outermost screw hole on the opposite side. Do not drive it all the way down—leave enough space under the screw head for thickness of the bracket.

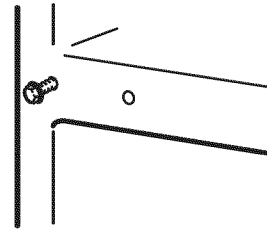

4 REVERSING THE HARDWARE

4.1 Move the bottom hinge bracket and plastic washer from the right side to the left side.

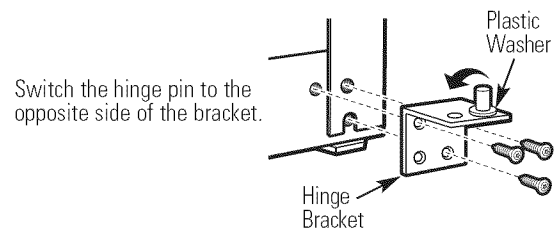

Installation Instructions

4 REVERSING THE HARDWARE (CONT.)

4.2 Interchange hinge and screws at top right with screws at top left of cabinet. **Do not tighten screws on hinge side at this time.**

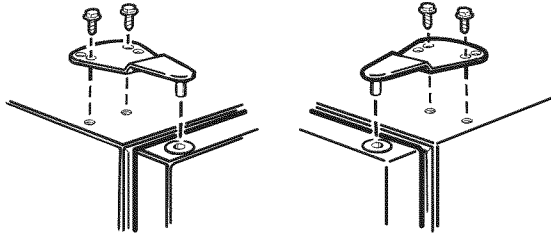

Installing the hinge on the left. Installing the hinge on the right.

NOTES:

- Some hinges have four holes. Which holes you use for installing the hinge depends on which side you install the hinge.
- The outer edge of the hinge should be parallel to the edge of the case for correct installation.

5 REVERSING THE DOOR HANDLES

5.1 Transfer fresh food door handle

5.1.1 Remove the handle plug using a tape-tipped putty knife under the edge, and remove the screw underneath. Remove the two screws holding the handle to the top of the door.

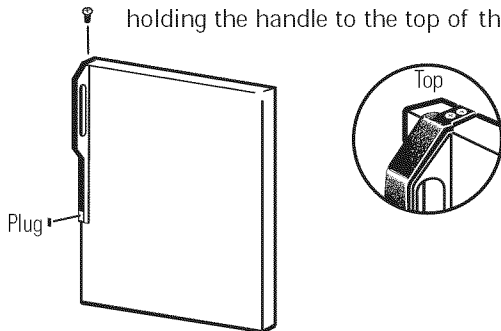

5.1.2 Remove the handle.

5 REVERSING THE DOOR HANDLES (CONT.)

5.1.3 Remove plug button from the top hinge hole on the left side of the door and insert it into the hole on the opposite side that was vacated by removal of the top hinge.

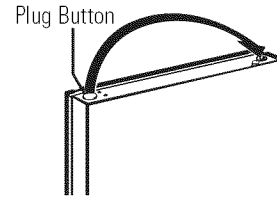

5.1.4 Pull the plug button from the front of the door and transfer it to the opposite side.

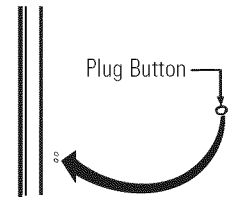

To reattach the handle on the opposite side.

5.2 Transfer door stop

5.2.1 Move the plastic door stop and screws from the right side to the left side.

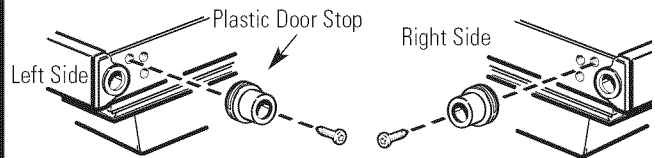

5.2.2 Move the metal door stop from the right side to the left side and transfer the screw to the opposite side of the door.

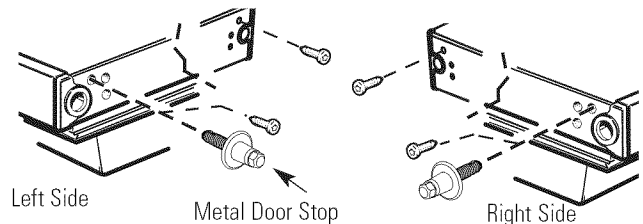

5.3 Reinstall the fresh food door handle

5.3.1 Attach the handle to the right side of the door with screws at the top and under the handle plug.

5.3.2 Reinstall the handle plug.

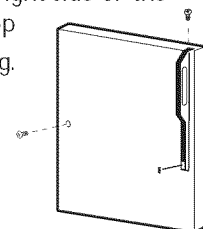

Installation Instructions

2 REVERSING THE DOOR SWING (CONT.)

5 REVERSING THE DOOR HANDLES (CONT.)

5.4 Transfer Freezer Door Handle

5.4.1 Remove the screw holding the handle to the top of the door and the two screws holding the handle to the bottom of the door.

5.4.2 Remove the handle.

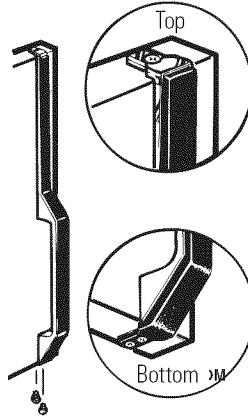

5.4.3 Remove the screw from the right top edge of the door and insert it into the handle screw hole on the left side.

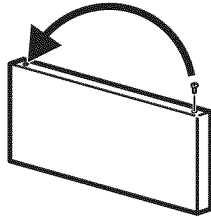

5.4.4 Transfer the door stop as shown in preceding section 5.2.

5.4.5 Attach the handle to the right edge of the door with screws at top and bottom, using bottom holes vacated by removal of the door stop screws.

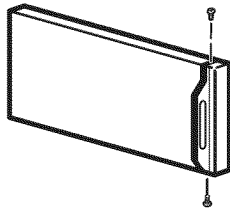

6 RE-HANGING THE DOORS

6.1 Re-hang the fresh food door

6.1.1 Lower the fresh food door onto the bottom hinge pin. **Be sure the washer is in place on the pin.**

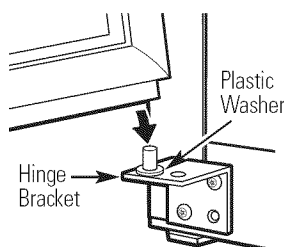

6 RE-HANGING THE DOORS (CONT.)

6.1.2 Insert the pin on the center hinge into the socket in the top of the door. Place the spacer, then the washer, on the hinge pin.

NOTE: The center hinge must be turned over as shown when mounted on the left side.

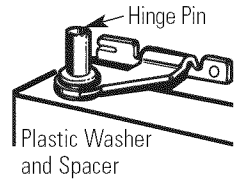

6.1.3 Tilt the door toward the cabinet. As the door is brought into position, slide the hinge under the head of the screw which earlier had been partly driven into the outermost hole. Insert the remaining screw, then tighten both screws securely.

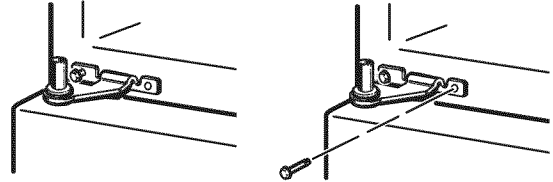

6.2 Re-hang the freezer door

6.2.1 Lower the freezer door onto the center hinge pin. **Be sure the washer and spacer are in place on the pin.**

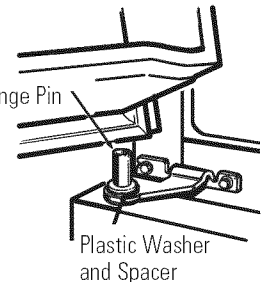

6.2.2 Tilt the door toward the cabinet, lifting the top hinge so the pin fits into the socket on the top of the door.

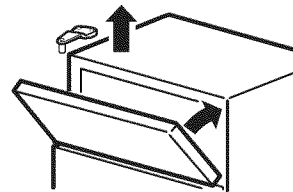

6.2.3 Make sure the door is slightly above the top of the cabinet and the gap between the doors is even across the front. Tighten the top hinge screws. Do not overtighten these screws—tighten them until they are just snug, then turn them another one-half turn.

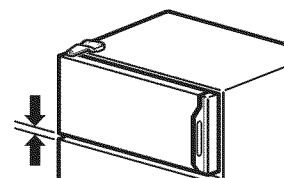



Newer refrigerators sound different from older refrigerators. Modern refrigerators have more features and use newer technology.

Do you hear what I hear? These sounds are normal.

- The new high efficiency compressor may run faster and longer than your old refrigerator and you may hear a high-pitched hum or pulsating sound while it is operating.
- You may hear a whooshing sound when the doors close. This is due to pressure equalizing within the refrigerator.

**HUMMM...
WHOOSH...**

WHIR!



- You may hear the fans spinning at high speeds. This happens when the refrigerator is first plugged in, when the doors are opened frequently or when

a large amount of food is added to the refrigerator or freezer compartments. The fans are helping to maintain the correct temperatures.

CLICKS, POPS, CRACKS and CHIRPS

- You may hear cracking or popping sounds when the refrigerator is first plugged in. This happens as the refrigerator cools to the correct temperature.
- The compressor may cause a clicking or chirping sound when attempting to restart (this could take up to 5 minutes).
- Expansion and contraction of cooling coils during and after defrost can cause a cracking or popping sound.
- On models with an icemaker, after an icemaking cycle, you may hear the ice cubes dropping into the ice bucket.



WATER SOUNDS

- The flow of refrigerant through the freezer cooling coils may make a gurgling noise like boiling water.
- Water dropping on the defrost heater can cause a sizzling, popping or buzzing sound during the defrost cycle.
- A water dripping noise may occur during the defrost cycle as ice melts from the evaporator and flows into the drain pan.
- Closing the door may cause a gurgling sound due to pressure equalization.



For additional information on normal icemaker operating sounds, see the **About the automatic icemaker** section.

Before you call for service...



Troubleshooting Tips
Save time and money! Review the charts on the following pages first and you may not need to call for service.

Problem	Possible Causes	What To Do
Refrigerator does not operate	Refrigerator in defrost cycle.	• Wait about 30 minutes for defrost cycle to end.
	Temperature control dial in OFF position.	• Move the temperature control dial to a temperature setting.
	Refrigerator is unplugged.	• Push the plug completely into the outlet.
	The fuse is blown/circuit breaker is tripped.	• Replace fuse or reset the breaker.
Vibration or rattling (slight vibration is normal)	Roller screws or leveling legs need adjusting.	• See Rollers and Leveling Legs.
Fresh food or freezer compartment too warm	Temperature control dial not set cold enough.	• See About the temperature control dial.
	Warm weather or frequent door openings.	• Set the temperature control dial one step colder. See About the temperature control dial.
	Door left open.	• Check to see if package is holding door open.
	Package blocking air duct in freezer compartment.	• Check to see if package is blocking air duct in freezer compartment.

Before you call for service...



Troubleshooting Tips

Problem	Possible Causes	What To Do
Motor operates for long periods or cycles on and off frequently. (Modern refrigerators with more storage space and a larger space and a larger freezer require more operating time. They start and stop often to maintain even temperatures.)	Normal when refrigerator is first plugged in.	<ul style="list-style-type: none"> • Wait 24 hours for the refrigerator to completely cool down.
	Often occurs when large amounts of food are placed in refrigerator.	<ul style="list-style-type: none"> • This is normal.
	Door left open.	<ul style="list-style-type: none"> • Check to see if package is holding door open.
	Hot weather or frequent door openings.	<ul style="list-style-type: none"> • This is normal.
	Temperature control dial set at the coldest setting.	<ul style="list-style-type: none"> • See About the temperature control dial.
	Grille and condenser need cleaning.	<ul style="list-style-type: none"> • See Care and cleaning.
Frost or ice crystals on frozen food (frost within package is normal)	Door left open.	<ul style="list-style-type: none"> • Check to see if package is holding door open.
	Too frequent or too long door openings.	
Automatic icemaker does not work (on some models)	Icemaker is not on.	<ul style="list-style-type: none"> • Move the feeler arm to the ON (down) position, or move the power switch to the ON position
	Water supply turned off or not connected.	<ul style="list-style-type: none"> • See Installing the water line.
	Freezer compartment too warm.	<ul style="list-style-type: none"> • Wait 24 hours for the refrigerator to completely cool down.
	Piled up cubes in the storage bin cause the icemaker to shut off.	<ul style="list-style-type: none"> • Level cubes by hand.
Frequent "buzzing" sound	Icemaker is on but the water supply to the refrigerator has not been connected	<ul style="list-style-type: none"> • Move the feeler arm to the STOP (up) position, or move the power switch to the OFF position, Keeping it on will damage the water valve..
Cubes too small	Water shutoff valve connecting refrigerator to water line may be clogged.	<ul style="list-style-type: none"> • Call the plumber to clear the valve.
Slow ice cube freezing	Door left open.	<ul style="list-style-type: none"> • Check to see if package is holding door open.
	Temperature control dial not set cold enough.	<ul style="list-style-type: none"> • See About the temperature control dial.
Ice cubes have odor/taste	Ice storage bin needs cleaning.	<ul style="list-style-type: none"> • Empty and wash bin. Discard old cubes.
	Food transmitting odor/taste to ice cubes.	<ul style="list-style-type: none"> • Wrap foods well.
	Interior of refrigerator needs cleaning.	<ul style="list-style-type: none"> • See Care and cleaning.
Moisture forms on cabinet surface between the doors	Not unusual during periods of high humidity.	<ul style="list-style-type: none"> • Wipe surface dry and reset temperature control dial one setting colder.
Moisture collects inside (in humid weather, air carries moisture into refrigerator when doors re opened)	Too frequent or too long door openings.	
Refrigerator has odor	Foods transmitting odor to refrigerator.	<ul style="list-style-type: none"> • Foods with strong odors should be tightly wrapped. • Keep an open box of baking soda in the refrigerator; replace every three months.
	Interior needs cleaning.	<ul style="list-style-type: none"> • See Care and cleaning.

Refrigerator Warranty. (For customers in the United States)

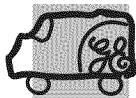

All warranty service provided by our Factory Service Centers, or an authorized Customer Care® technician. To schedule service, on-line, 24 hours a day, visit us at GEAppliances.com, or call 800.GE.CARES (800.432.2737). Please have serial number and model number available when calling for service.

Staple your receipt here. Proof of the original purchase date is needed to obtain service under the warranty.

For The Period Of: GE Will Replace:

GE and GE PROFILE MODELS:

<p>One Year From the date of the original purchase</p>	<p>Any part of the refrigerator which fails due to a defect in materials or workmanship. During this limited one-year warranty, GE will also provide, free of charge, all labor and related service to replace the defective part.</p>
<p>Thirty Days (Water filter, if included) From the original purchase date of the refrigerator</p>	<p>Any part of the water filter cartridge which fails due to a defect in materials or workmanship. During this limited thirty-day warranty, GE will also provide, free of charge, a replacement water filter cartridge.</p>

GE PROFILE MODELS ONLY:

<p>Five Years (GE Profile models only) From the date of the original purchase</p>	<p>Any part of the sealed refrigerating system (the compressor, condenser, evaporator and all connecting tubing) which fails due to a defect in materials or workmanship. During this limited five-year sealed refrigerating system warranty, GE will also provide, free of charge, all labor and related service to replace the defective part in the sealed refrigerating system.</p>
---	---

What GE Will Not Cover:

- Service trips to your home to teach you how to use the product.
- Improper installation, delivery or maintenance.
- Failure of the product if it is abused, misused, or used for other than the intended purpose or used commercially.
- Loss of food due to spoilage.
- Replacement of house fuses or resetting of circuit breakers.
- Damage caused after delivery.
- Products which are not defective, broken or which are working as described in the Owner's manual.
- Replacement of the water filter cartridge, if included, due to water pressure that is outside the specified operating range or due to excessive sediment in the water supply.
- Replacement of the light bulbs, if included, or water filter cartridge, if included, other than as noted above.
- Damage to the product caused by accident, fire, floods or acts of God.
- Incidental or consequential damage caused by possible defects with this appliance.
- Product not accessible to provide required service.

EXCLUSION OF IMPLIED WARRANTIES—Your sole and exclusive remedy is product repair as provided in this Limited Warranty. Any implied warranties, including the implied warranties of merchantability or fitness for a particular purpose, are limited to one year or the shortest period allowed by law.

This warranty is extended to the original purchaser and any succeeding owner for products purchased for home use within the USA. If the product is located in an area where service by a GE Authorized Servicer is not available, you may be responsible for a trip charge or you may be required to bring the product to an Authorized GE Service location for service. In Alaska, the warranty excludes the cost of shipping or service calls to your home.

Some states do not allow the exclusion or limitation of incidental or consequential damages. This warranty gives you specific legal rights, and you may also have other rights which vary from state to state. To know what your legal rights are, consult your local or state consumer affairs office or your state's Attorney General.

Consumer Support.



GE Appliances Website

GEAppliances.com

In the U.S.: **www.Hotpoint.com**

Have a question or need assistance with your appliance? Try the GE Appliances Website 24 hours a day, any day of the year! For greater convenience and faster service, you can now download Owner's Manuals, order parts, or even schedule service on-line. **In Canada: www.geappliances.ca**

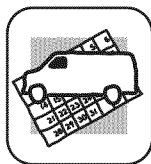

Schedule Service

GEAppliances.com

In the U.S.: **www.Hotpoint.com**

Expert GE repair service is only one step away from your door. Get on-line and schedule your service at your convenience 24 hours any day of the year! Or call 800.GE.CARES (800.432.2737) during normal business hours.

In Canada, call 1.800.561.3344

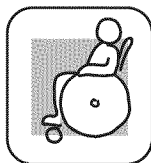

Real Life Design Studio

In the U.S.: **GEAppliances.com**

GE supports the Universal Design concept—products, services and environments that can be used by people of all ages, sizes and capabilities. We recognize the need to design for a wide range of physical and mental abilities and impairments. For details of GE's Universal Design applications, including kitchen design ideas for people with disabilities, check out our Website today. For the hearing impaired, please call 800.TDD.GEAC (800.833.4322).

In Canada, contact: Manager, Consumer Relations, Mabe Canada Inc.
Suite 310, 1 Factory Lane
Moncton, N.B. E1C 9M3



Extended Warranties

In the U.S.: **GEAppliances.com**

Purchase a GE extended warranty and learn about special discounts that are available while your warranty is still in effect. You can purchase it on-line anytime, or call 1.888.261.2133 during normal business hours. GE Consumer Home Services will still be there after your warranty expires.

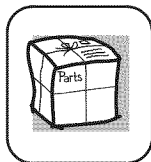

Parts and Accessories

GEAppliances.com

In the U.S.: **www.Hotpoint.com**

Individuals qualified to service their own appliances can have parts or accessories sent directly to their homes (VISA, MasterCard and Discover cards are accepted). Order on-line today, 24 hours every day or by phone at 1.800.661.1616 during normal business hours.

Instructions contained in this manual cover procedures to be performed by any user. Other servicing generally should be referred to qualified service personnel. Caution must be exercised, since improper servicing may cause unsafe operation. Customers **in Canada** should consult the yellow pages for the nearest Mabe service center, or call 1.800.661.1616.



Contact Us

GEAppliances.com

In the U.S.: **www.Hotpoint.com**

If you are not satisfied with the service you receive from GE, contact us on our Website with all the details including your phone number, or write to:

General Manager, Customer Relations
GE Appliances, Appliance Park
Louisville, KY 40225

In Canada: www.geappliances.ca, or write to: Director, Consumer Relations, Mabe Canada Inc.
Suite 310, 1 Factory Lane
Moncton, N.B. E1C 9M3



Register Your Appliance

GEAppliances.com

In the U.S.: **www.Hotpoint.com**

Register your new appliance on-line—at your convenience! Timely product registration will allow for enhanced communication and prompt service under the terms of your warranty, should the need arise. You may also mail in the pre-printed registration card included in the packing material.

In Canada: www.geappliances.ca



Top-Freezer Refrigerators

Safety Instructions 2-4

Operating Instructions

Automatic Icemaker 7
Care and Cleaning 8
Shelves 5, 6
Storage Drawers 6
Temperature Controls 5

Installation Instructions

Preparing to Install
the Refrigerator 9
Reversing the Door Swing 13-16
Water Line Installation 10-12

Troubleshooting Tips

Before You Call For Service 17, 18
Normal Operating Sounds 17

Consumer Support

Consumer Support Back Cover
Refrigerator Warranty 19

**Owner's Manual and
Installation Instructions**

Models 16, 17, 18

**Write the model and serial
numbers here:**

Model # _____

Serial # _____

You can find them on a label on
the upper left side of the fresh food
compartment.

IMPORTANT SAFETY INFORMATION. READ ALL INSTRUCTIONS BEFORE USING.

⚠ DANGER! RISK OF CHILD ENTRAPMENT PROPER DISPOSAL OF THE REFRIGERATOR

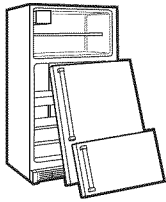

Child entrapment and suffocation are not problems of the past. Junked or abandoned refrigerators are still dangerous...even if they will sit for "just a few days." If you are getting rid of your old refrigerator, please follow the instructions below to help prevent accidents.

Before You Throw Away Your Old Refrigerator or Freezer:

- Take off the doors.
- Leave the shelves in place so that children may not easily climb inside.
- If the refrigerator has a lock make it unusable

Refrigerants

All refrigeration products contain refrigerants, which under federal law must be removed prior to product disposal. If you are getting rid of an old refrigeration product, check with the company handling the disposal about what to do.

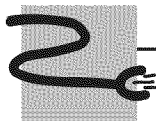

USE OF EXTENSION CORDS

Because of potential safety hazards under certain conditions, we strongly recommend against the use of an extension cord.

However, if you must use an extension cord, it is absolutely necessary that it be a UL-listed (in the United States) or a CSA certified (in Canada), 3-wire grounding type appliance extension cord having a grounding type plug and outlet and that the electrical rating of the cord be 15 amperes (minimum) and 120 volts.

⚠ DANGER! RISQUES POUR LES ENFANTS COMMENT VOUS DÉBARRASSER CONVENABLEMENT DE VOTRE ANCIEN RÉFRIGÉRATEUR

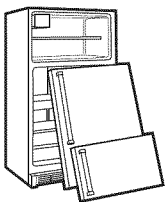

Les enfants pris au piège ou morts d'asphyxie sont toujours d'actualité. Les réfrigérateurs abandonnés sont toujours aussi dangereux, même si on n'attend que «quelques jours» pour s'en débarrasser. Si vous ne gardez pas votre ancien réfrigérateur, veuillez suivre les directives ci-dessous afin de prévenir les accidents.

Avant de vous débarrasser de votre ancien réfrigérateur ou congélateur :

- Démontez les portes.
- Laissez les clayettes en place afin d'empêcher les enfants de grimper à l'intérieur.

Réfrigérants

Tous les appareils de réfrigération contiennent des réfrigérants qui, conformément aux lois fédérales, doivent être enlevés avant toute élimination de l'appareil. Si vous vous débarrassez de vieux appareils de réfrigération, vérifiez, auprès de la société qui s'occupe de leur élimination, ce que vous devez faire.

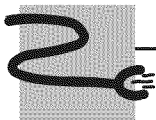

CORDONS PROLONGATEURS

Nous vous recommandons fortement de ne pas utiliser de cordons prolongateurs à cause des risques potentiels qu'ils présentent dans certaines conditions.

Toutefois si vous décidez d'utiliser tout de même un cordon prolongateur, il est absolument nécessaire qu'il s'agisse d'un cordon à 3 fils avec mise à la terre pour appareils électroménagers homologué UL (aux États-Unis) ou certifié CSA (au Canada), pourvu d'une fiche et d'une prise mises à la terre de 15 ampères (minimum) et de 120 volts.

IMPORTANT SAFETY INFORMATION. READ ALL INSTRUCTIONS BEFORE USING.

GEAppliances.com

⚠ WARNING!

Use this appliance only for its intended purpose as described in this Owner's Manual.



SAFETY PRECAUTIONS

When using electrical appliances, basic safety precautions should be followed, including the following:

- This refrigerator must be properly installed and located in accordance with the Installation Instructions before it is used.
- Do not attempt to or allow children to climb, stand or hang on the shelves in the refrigerator. They could damage the refrigerator and seriously injure themselves.
- Do not touch the cold surfaces in the freezer compartment when hands are damp or wet. Skin may stick to these extremely cold surfaces.
- Do not store or use gasoline or other flammable vapors and liquids in the vicinity of this or any other appliance.
- Keep fingers out of the "pinch point" areas; clearances between the doors and between the doors and cabinet are necessarily small. Be careful closing doors when children are in the area.
- Unplug the refrigerator before cleaning and making repairs.
- In refrigerators with automatic icemakers, avoid contact with the moving parts of the ejector mechanism, or with the heating element that releases the cubes. Do not place fingers or hands on the automatic icemaking mechanism while the refrigerator is plugged in.

NOTE: We strongly recommend that any servicing be performed by a qualified individual.
- Turning the temperature control to the **OFF** position does not remove power to the light circuit.
- Do not refreeze frozen foods which have thawed completely.
- Do not allow children to play with refrigerator or tamper with controls.
- **Before replacing a burned-out light bulb, the refrigerator should be unplugged** in order to avoid contact with a live wire filament. (A burned-out light may break when being replaced.)

MESURES DE SÉCURITÉ IMPORTANTES. LISEZ D'ABORD TOUTES LES DIRECTIVES.

⚠ AVERTISSEMENT!

N'utilisez cet électroménager que pour l'usage auquel il est destiné, comme expliqué dans le présent manuel.



MESURES DE SÉCURITÉ

Lorsque vous utilisez un appareil électrique, observez toujours les mesures de sécurité de base, y compris les suivantes.

- Installez le réfrigérateur conformément aux directives d'installation avant de l'utiliser.
- Ne laissez pas les enfants grimper, s'asseoir, se tenir debout ni se pendre aux clayettes du réfrigérateur. Ils pourraient endommager le réfrigérateur et se blesser gravement.
- N'entreposez et n'utilisez pas d'essence ou autres vapeurs et liquides inflammables à proximité de cet appareil ou de tout autre appareil électroménager.
- Éloignez les doigts des parties du réfrigérateur où l'on peut facilement se pincer : les espaces entre les portes et entre les portes et les placards sont toujours étroits. Soyez prudent lorsque vous fermez les portes de l'appareil en présence des enfants.
- Débranchez votre réfrigérateur avant de le nettoyer ou de le réparer.
- Si votre réfrigérateur est doté d'une machine à glaçons automatique évitez le contact avec les pièces mobiles du mécanisme éjecteur, ou avec l'élément chauffant qui libère les glaçons.
Ne posez pas les doigts ou les mains sur le mécanisme de la machine à glaçons pendant que le réfrigérateur est branché.
- Ne touchez pas les surfaces froides du congélateur si vous avez les mains humides ou mouillées : la peau risque d'adhérer à ces surfaces très froides.

REMARQUE : Nous vous recommandons vivement de confier toute réparation à un technicien qualifié.
- Lorsque vous réglez la commande sur 0 (éteint), l'alimentation électrique de l'ampoule n'est pas coupée.
- Ne recongelez pas les aliments surgelés qui ont complètement dégelé.
- Le réfrigérateur doit être débranché avant de remplacer l'ampoule afin d'éviter tout contact avec un fil de câble sous tension.

IMPORTANT SAFETY INFORMATION. READ ALL INSTRUCTIONS BEFORE USING.

⚠ WARNING!

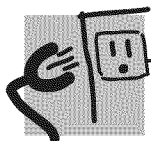

HOW TO CONNECT ELECTRICITY

Do not, under any circumstances, cut or remove the third (ground) prong from the power cord. For personal safety, this appliance must be properly grounded.

The power cord of this appliance is equipped with a 3-prong (grounding) plug which mates with a standard 3-prong (grounding) wall outlet to minimize the possibility of electric shock hazard from this appliance.

Have the wall outlet and circuit checked by a qualified electrician to make sure the outlet is properly grounded.

Where a standard 2-prong wall outlet is encountered, it is your personal responsibility and obligation to have it replaced with a properly grounded 3-prong wall outlet.

The refrigerator should always be plugged into its own individual electrical outlet which has a voltage, wattage and frequency that match the rating plate.

This provides the best performance and also prevents overloading house wiring circuits which could cause a fire hazard from overheated wires.

Never unplug your refrigerator by pulling on the power cord. Always grip plug firmly and pull straight out from the outlet.

Repair or replace immediately all power cords that have become frayed or otherwise damaged. Do not use a cord that shows cracks or abrasion damage along its length or at either end.

When moving the refrigerator away from the wall, be careful not to roll over or damage the power cord.



READ AND FOLLOW THIS SAFETY INFORMATION CAREFULLY.

SAVE THESE INSTRUCTIONS

MESURES DE SÉCURITÉ IMPORTANTES. LISEZ D'ABORD TOUTES LES DIRECTIVES.

⚠ AVERTISSEMENT!

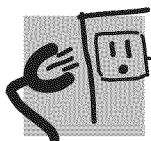

RACCORDEMENT ÉLECTRIQUE

Ne coupez ni retirez en aucun cas la troisième broche (mise à la terre) de la fiche du cordon d'alimentation. Pour votre sécurité, cet appareil doit être correctement mis à la terre.

Le cordon d'alimentation de cet appareil est muni d'une fiche à 3 broches (mise à la terre) qui se branche dans une prise murale ordinaire à 3 alvéoles (mise à la terre) pour réduire au minimum les risques de chocs électriques.

Faites examiner la prise de courant et le circuit par un électricien qualifié pour vous assurer que la prise est correctement mise à la terre.

Si la prise murale est du type standard à 2 alvéoles, il vous incombe de la faire remplacer par une prise à 3 alvéoles correctement mise à la terre.

Le réfrigérateur doit toujours être branché dans sa propre prise de courant, dont la tension nominale est identique à celle indiquée sur la plaque signalétique.

Cette précaution est recommandée pour garantir un rendement optimum et éviter une surcharge des circuits électriques de la résidence, ce qui pourrait créer un risque d'incendie par surchauffe des fils.

Ne débranchez jamais le réfrigérateur en tirant sur le cordon d'alimentation. Saisissez fermement la fiche du cordon et tirez droit pour la retirer de la prise.

Réparez ou remplacez immédiatement tout cordon effiloché ou endommagé. N'utilisez pas un cordon fendillé ou présentant des signes d'usure.

Lorsque vous déplacez votre réfrigérateur du mur, faites attention de ne pas le faire rouler sur le cordon d'alimentation afin de ne pas l'endommager.



VEUILLEZ LIRE ET SUIVRE ATTENTIVEMENT CES MESURES DE SÉCURITÉ.

CONSERVEZ CES DIRECTIVES

About the temperature control dial.

Turning the dial to **0/ Off** stops cooling in both compartments—fresh food and freezer. It does not shut off power to the refrigerator.

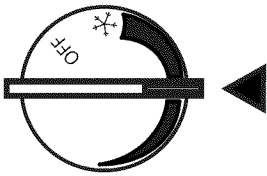

Temperature Control Dial (on some models)

The temperature control dial adjust refrigerator from warmest to coldest. The recommended factory setting is shown in illustration to the left. For colder temperature turn dial clockwise toward snowflake. For warmer temperature turn dial counter clockwise away from snowflake. allow 24 hours for adjustment.

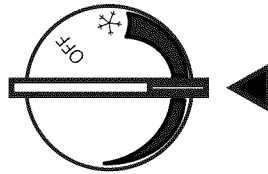

Recommended factory setting

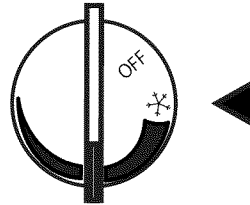

Coldest setting

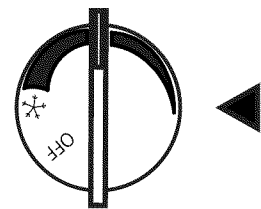

Warmest setting

About the fresh food compartment shelves.

Shelf supports at various levels allow you to custom-space your shelves. Not all features are on all models.

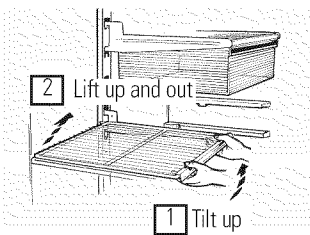

Half-Width Shelves

One end of the shelf rests on a molded side-wall support; a bracket on the other end hooks into a track on the rear cabinet wall. To remove, lift the shelf up at front, then off the support and out of the track. To replace, select desired shelf height. With shelf front raised slightly, hook the bracket's top lug into the track, then lower the shelf onto the support.

NOTE: The shelf to the right of the track is designed to hook into the right-hand slot; the shelf to the left is designed to hook into the left-hand slot.

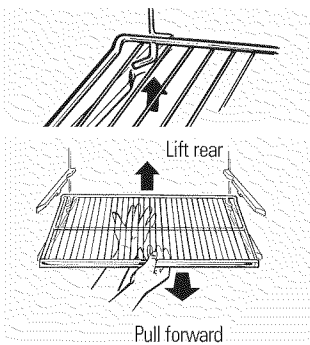
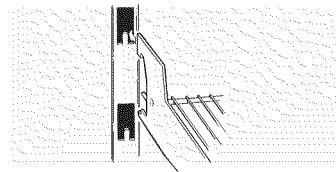

Full-Width Shelves

Some models have a stationary tempered glass shelf, a spillproof shelf, or two steel wire stationary shelves. These shelves can be moved to another place in the fresh food compartment.

When placed correctly on the shelf supports, the shelf will stop before coming completely out of the refrigerator and will not tilt when you place food on it or remove food from it.

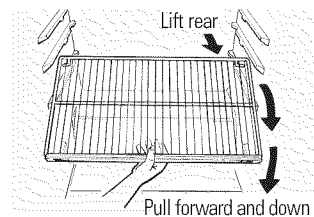

To remove a full-width shelf when the fresh food compartment door cannot be opened fully

To remove the full-width shelves

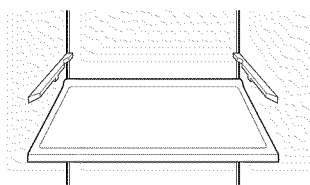

Spillproof Shelves (on some models)

Spillproof shelves have special edges to help prevent spills from dripping to lower shelves. To remove or replace the shelves, see the above instructions.

About the freezer compartment shelves.

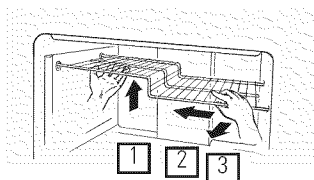

Step Shelf (on some models)

To remove the step shelf:

- 1 Lift left side of shelf slightly.
- 2 Move shelf to the left to free its right ends from holes in the cabinet wall.
- 3 Lower right side of shelf, move shelf to the right and take it out.

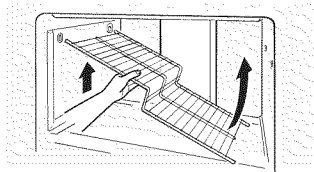

To replace the step shelf:

- 1 With shelf tilted as shown, fit left ends of shelf into holes in cabinet wall.
- 2 Lift left side of shelf slightly, swing shelf up, fit right ends of shelf into holes in cabinet wall, and lower shelf into place.

About the storage drawers.

Not all features are on all models.

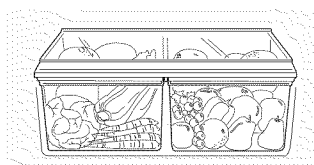

Fruit and Vegetable Drawers

Excess water that may accumulate in the bottom of the drawers should be emptied and the drawers wiped dry.

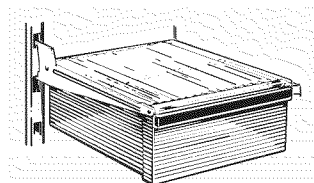

Snacks Drawer

The snacks drawer can be moved to the most useful location for your family's needs.

About storage drawer and cover removal.

Not all features are on all models.

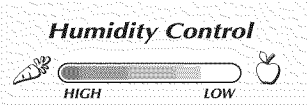

Adjustable Humidity Drawer (on some models)

Slide the control all the way to the HIGH setting to provide high humidity recommended for most vegetables.

Slide the control all the way to the LOW setting to provide lower humidity levels recommended for most fruits.

Drawer and Cover Removal

Drawers can be removed easily by grasping the sides and lifting up slightly while pulling drawers past the stop location.

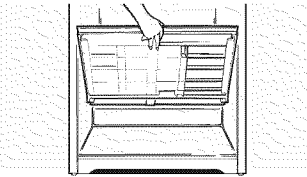

Full-Width Drawer with Plastic Cover

To remove the cover, lift it off its supports, pull it forward, tilt it and take it out.

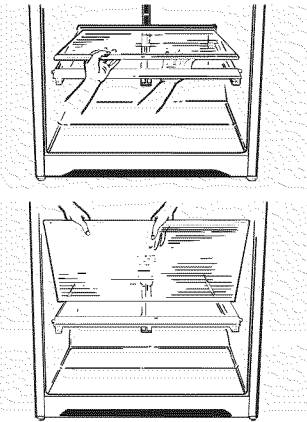

Twin Drawer Shelf

To remove:

- 1 Remove the drawers.
 - 2 Reach in, push the front of glass cover up, and at the same time, pull it forward as far as it will come.
- Tilt it and take it out. Avoid cleaning the cold glass cover with hot water because the extreme temperature difference may cause it to break.
- 3 Remove the drawer frame. (Always remove the glass cover before you take out the drawer frame.)

To replace:

- 1 Lower the frame until it rests on the supports at each side and back.
- 2 Replace the glass cover, pushing its rear edge firmly into the rear frame channel and gently lowering the front into place.
- 3 Replace the drawers.

Lift the frame off the supports at each side and back, pull it forward, tilt it and take it out.

About the automatic icemaker.

A newly-installed refrigerator may take 12 to 24 hours to begin making ice.

There are 2 types of icemakers:

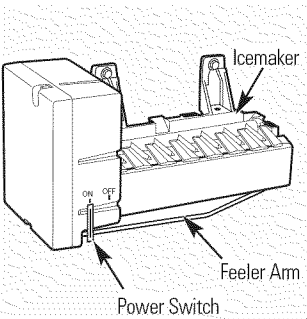

Power switch model

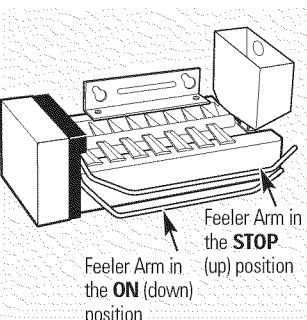

Feeler arm model

Automatic Icemaker (on some models)

The icemaker will produce approximately 70-100 cubes in a 24-hour period, depending on the freezer compartment temperature, room temperature, number of door openings and other use conditions.

If the refrigerator is operated before the water connection is made to the icemaker, set the switch to OFF or move the feeler arm to the STOP (up) position.

When the refrigerator has been connected to the water supply, set the switch to the ON position or move the feeler arm to the ON (down) position.

The icemaker will fill with water when it cools to 15°F. A newly-installed refrigerator may take 12 to 24 hours to begin making ice cubes.

Once the icemaker starts to make ice, it may take up to 48 hours to fill the bin, depending on the temperature settings and number of door openings.

You will hear a buzzing sound each time the icemaker fills with water.

Throw away the first few batches of ice to allow the water line to clear.

Be sure nothing interferes with the sweep of the feeler arm.

When the bin fills to the level of the feeler arm, the icemaker will stop producing ice.

It is normal for several cubes to be joined together.

If ice is not used frequently, old ice cubes will become cloudy, taste stale, shrink or fuse together.

Icemaker Accessory Kit

If your refrigerator did not already come equipped with an automatic icemaker, an icemaker accessory kit is available at extra cost.

Check the back of the refrigerator for the specific icemaker kit needed for your model.

Care and cleaning of the refrigerator.

Cleaning the Outside

The door handles and trim (on some models). Clean with a cloth dampened with soapy water. Dry with a soft cloth.

Keep the outside clean. Wipe with a clean cloth lightly dampened with kitchen appliance wax or mild liquid dish detergent. Dry and polish with a clean, soft cloth.

The stainless steel panels and door handles (on some models) can be cleaned with a commercially available stainless steel cleaner. Do not use appliance wax or polish on the stainless steel.

Do not wipe the refrigerator with a soiled dish cloth or wet towel. These may leave a residue that can erode the paint. Do not use scouring pads, powdered cleaners, bleach or cleaners containing bleach because these products can scratch and weaken the paint finish.

Cleaning the Inside

To help prevent odors, leave an open box of baking soda in the fresh food and freezer compartments.

Unplug the refrigerator before cleaning. If this is not practical, wring excess moisture out of sponge or cloth when cleaning around switches, lights or controls.

Use warm water and baking soda solution—about a tablespoon (15 ml) of baking soda to a quart (1 liter) of water. This both cleans and neutralizes odors. Rinse and wipe dry.

After cleaning the door gaskets, apply a thin layer of petroleum jelly to the door gaskets at the hinge side. This helps keep the gaskets from sticking and bending out of shape.

Avoid cleaning cold glass shelves (on some models) with hot water because the extreme temperature difference may cause them to break. Handle glass shelves carefully. Bumping tempered glass can cause it to shatter.

Do not wash any plastic refrigerator parts in the dishwasher.

Condenser

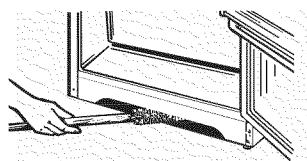

Cleaning the condenser coils.

There is no need for routine condenser cleaning in normal home operating environments. However, in environments that may be particularly dusty or greasy, the condenser should be

cleaned periodically for efficient refrigerator operation.

To clean the condenser, turn the temperature control dial to **OFF**. Sweep away or vacuum up dust.

For best results, use a brush specially designed for this purpose. It is available at most appliance parts stores.

Moving the Refrigerator

Be careful when moving the refrigerator away from the wall. All types of floor coverings can be damaged, particularly cushioned coverings and those with embossed surfaces.

Turn the leveling legs at each front corner of the refrigerator counterclockwise until the rollers support the refrigerator. Pull the refrigerator straight out and return it to position by pushing it straight in. Moving the refrigerator in a side direction may result in damage to the floor covering or refrigerator.

When pushing the refrigerator back, make sure you don't roll over the power cord or icemaker supply line (on some models).

After rolling the refrigerator back into place, turn the legs clockwise until the legs again bear the weight of the refrigerator.

Light Bulb Replacement

To replace a burned-out bulb, unplug the refrigerator from its electrical outlet, unscrew the bulb when cool and replace it with an appliance bulb of the same or lower wattage.

Turning the control to the **OFF** position does not remove power to the light circuit.

Preparing for Vacation

For long vacations or absences, remove food and unplug the refrigerator. Move the temperature control dial to the **OFF** position, and clean the interior with a baking soda solution of one tablespoon (15 ml) of baking soda to one quart (1 liter) of water. Leave the doors open.

Move the feeler arm to the **STOP** (up) position, or move the switch to the **OFF** position on the slide switch model and shut off the water supply to the refrigerator.

If the temperature can drop below freezing, have a qualified servicer drain the water supply system (on some models) to prevent serious property damage due to flooding.

Preparing to Move

Secure all loose items such as grille, shelves and drawers by taping them securely in place to prevent damage. Be sure the refrigerator stays in an upright position during moving.

Installation Instructions *Models 16, 17, 18*

If you have questions, call 1.800.GE.CARES or visit our Website at: GEAppliances.com
In Canada, call 1.800.561.3344 or Visit our Website at: www.geappliances.ca

BEFORE YOU BEGIN

Read these instructions completely and carefully.

- **IMPORTANT** – Save these instructions for local inspector's use.
- **IMPORTANT** – Observe all governing codes and ordinances.
- **Note to Installer** – Be sure to leave these instructions with the Consumer.
- **Note to Consumer** – Keep these instructions for future reference.
- **Skill level** – Installation of this appliance requires basic mechanical skills.
- **Completion time** – Refrigerator Installation
15 minutes
Reversing the Door Swing
1 hour
- Proper installation is the responsibility of the installer.
- Product failure due to improper installation is not covered under the Warranty.

WATER SUPPLY TO THE ICEMAKER (on some models)

If the refrigerator has an icemaker, it will have to be connected to a cold water line. A water supply kit (containing copper tubing, shutoff valve, fittings and instructions) is available at extra cost from your dealer, by visiting our Website at GEAppliances.com (in Canada at www.geappliances.ca) or from Parts and Accessories, 1.800.661.1616.

REFRIGERATOR LOCATION

- Do not install the refrigerator where the temperature will go below 60°F (16°C) because it will not run often enough to maintain proper temperatures.
- Install it on a floor strong enough to support it fully loaded.

CLEARANCES

Allow the following clearances for ease of installation, proper air circulation and plumbing and electrical connections.

- Sides 3/4" (19 mm)
- Top 1" (25 mm)
- Back 2" (50 mm)

ROLLERS AND LEVELING LEGS

Leveling legs near each front corner of the refrigerator are adjustable. They firmly position the refrigerator and prevent it from moving when the doors are opened. Leveling legs should be set so the front of the refrigerator is raised just enough that the doors close easily when opened about halfway.

Turn the leveling legs **clockwise to raise** the refrigerator, **counterclockwise to lower it**.

Rollers next to the leveling legs allow you to move the refrigerator away from the wall for cleaning.

Turn the legs counterclockwise until the weight of the refrigerator is transferred from them to the rollers. After rolling the refrigerator back into place, turn the legs clockwise until the legs again bear the weight of the refrigerator.

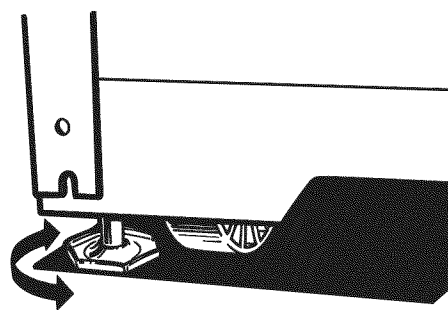

Installation Instructions

1 INSTALLING THE WATER LINE (ON SOME MODELS)

BEFORE YOU BEGIN

Recommended copper water supply kits are WX8X2, WX8X3 or WX8X4, depending on the amount of tubing you need. Approved plastic water supply lines are GE SmartConnect™ Refrigerator Tubing (WX08X10006, WX08X10015 and WX08X10025).

When connecting your refrigerator to a GE Reverse Osmosis Water System, the only approved installation is with a GE RVKit. For other reverse osmosis water systems, follow the manufacturer's recommendations.

This water line installation is not warranted by the refrigerator or icemaker manufacturer. Follow these instructions carefully to minimize the risk of expensive water damage.

Water hammer (water banging in the pipes) in house plumbing can cause damage to refrigerator parts and lead to water leakage or flooding. Call a qualified plumber to correct water hammer before installing the water supply line to the refrigerator.

To prevent burns and product damage, do not hook up the water line to the hot water line.

If you use your refrigerator before connecting the water line, make sure the switch is set to **OFF** or the feeler arm in the **STOP** (up) position.

Do not install the icemaker tubing in areas where temperatures fall below freezing.

When using any electrical device (such as a power drill) during installation, be sure the device is double insulated or grounded in a manner to prevent the hazard of electric shock, or is battery powered.

All installations must be in accordance with local plumbing code requirements.

WHAT YOU WILL NEED

- **Copper or GE SmartConnect™ Refrigerator Tubing kit**, 1/4" outer diameter to connect the refrigerator to the water supply. If using copper, be sure both ends of the tubing are cut square.

To determine how much tubing you need: measure the distance from the water valve on the back of the refrigerator to the water supply pipe. Then add 8' (2.4 m). Be sure there is sufficient extra tubing (about 8' [2.4 m] coiled into 3 turns of about 10" [25 cm] diameter) to allow the refrigerator to move out from the wall after installation.

WHAT YOU WILL NEED (CONT.)

GE SmartConnect™ Refrigerator Tubing Kits are available in the following lengths:

- 6' (1.8 m) – WX08X10006
- 15' (4.6 m) – WX08X10015
- 25' (7.6 m) – WX08X10025

Be sure that the kit you select allows at least 8' (2.4 m) as described above.

NOTE: The only GE approved plastic tubing is that supplied in GE SmartConnect™ Refrigerator Tubing kits. Do not use any other plastic water supply line because the line is under pressure at all times. Certain types of plastic will crack or rupture with age and cause water damage to your home.

- **A GE water supply kit** (containing tubing, shutoff valve and fittings listed below) is available at extra cost from your dealer or from Parts and Accessories, 1.800.661.1616.
- **A cold water supply.** The water pressure must be between 20 and 120 p.s.i. (1.4–8.1 bar).
- **Power drill.**
- **1/2" or adjustable wrench.**
- **Straight and Phillips blade screwdriver.**
- **Two 1/4" outer diameter compression nuts and 2 ferrules (sleeves)**—to connect the copper tubing to the shutoff valve and the refrigerator water valve.

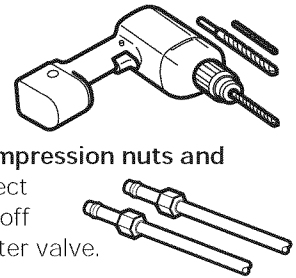

OR

- If you are using a GE SmartConnect™ Refrigerator Tubing kit, the necessary fittings are preassembled to the tubing.
- If your existing copper water line has a flared fitting at the end, you will need an **adapter** (available at plumbing supply stores) to connect the water line to the refrigerator **OR** you can cut off the flared fitting with a **tube cutter** and then use a compression fitting. Do not cut formed end from GE SmartConnect™ Refrigerator tubing.

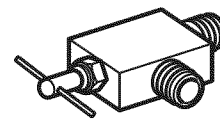

- **Shutoff valve** to connect to the cold water line. The shutoff valve should have a water inlet with a minimum inside diameter of 5/32" at the point of connection to the **COLD WATER LINE**. Saddle-type shutoff valves are included in many water supply kits. Before purchasing, make sure a saddle-type valve complies with your local plumbing codes.

Installation Instructions

Install the shutoff valve on the nearest frequently used drinking water line.

1 SHUT OFF THE MAIN WATER SUPPLY AND UNPLUG REFRIGERATOR

Turn on the nearest faucet (counterclockwise) long enough to clear the line of water.

2 DRILL THE HOLE FOR THE VALVE

Choose a location for the valve that is easily accessible. It is best to connect into the side of a vertical water pipe. When it is necessary to connect into a horizontal water pipe, make the connection to the top or side, rather than at the bottom, to avoid drawing off any sediment from the water pipe.

Drill a 1/4" hole in the water pipe (even if using a self-piercing valve), using a sharp bit. Remove any burrs resulting from drilling the hole in the pipe. **Take care not to allow water to drain into the drill.** Failure to drill a 1/4" hole may result in reduced ice production or smaller cubes.

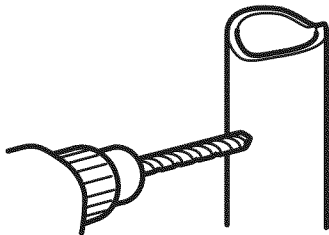

3 FASTEN THE SHUTOFF VALVE

Fasten the shutoff valve to the cold water pipe with the pipe clamp.

Tighten the clamp screws until the sealing washer begins to swell.

NOTE: Do not overtighten or you may crush the tubing.

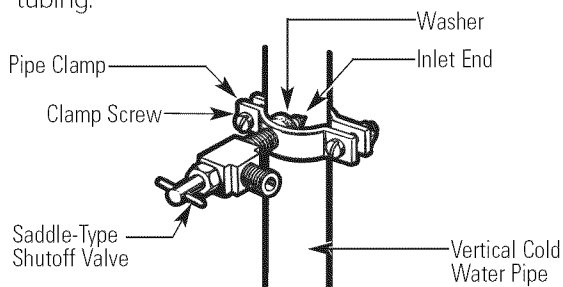

NOTE: Commonwealth of Massachusetts Plumbing Codes 248CMR shall be adhered to. Saddle valves are illegal and use is not permitted in Massachusetts. Consult with your licensed plumber.

4 ROUTE THE TUBING

Route the tubing between the cold water line and the refrigerator.

Route the tubing through a hole drilled in the wall or floor (behind the refrigerator or adjacent base cabinet) as close to the wall as possible.

NOTE: Be sure there is sufficient extra tubing (about 8 feet [244 cm] coiled into 3 turns of about 10" [25 cm] diameter) to allow the refrigerator to move out from the wall after installation.

5 CONNECT THE TUBING TO THE VALVE

Place the compression nut and ferrule (sleeve) for copper tubing onto the end of the tubing and connect it to the shutoff valve.

Make sure the tubing is fully inserted into the valve. Tighten the compression nut securely.

For plastic tubing from a GE SmartConnect™ Refrigerator Tubing kit, insert the molded end of the tubing into the shutoff valve and tighten compression nut until it is hand tight, then tighten one additional turn with a wrench. Overtightening may cause leaks.

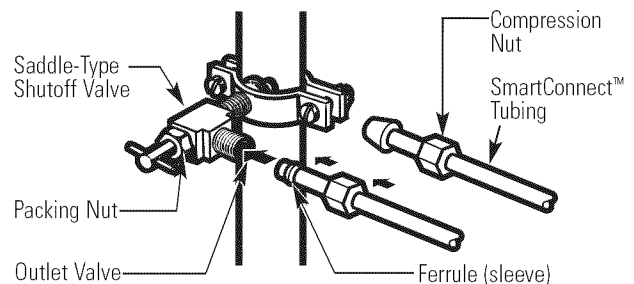

NOTE: Commonwealth of Massachusetts Plumbing Codes 248CMR shall be adhered to. Saddle valves are illegal and use is not permitted in Massachusetts. Consult with your licensed plumber.

6 FLUSH OUT THE TUBING

Turn the main water supply on (counterclockwise) and flush out the tubing until the water is clear.

Shut the water off at the water valve after about one quart (1 liter) of water has been flushed through the tubing.

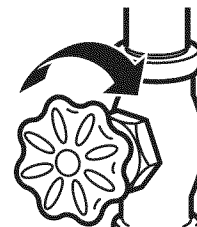

Installation Instructions

1 INSTALLING THE WATER LINE (CONT.)

7 CONNECT THE TUBING TO THE REFRIGERATOR

NOTES:

- Before making the connection to the refrigerator, be sure the refrigerator power cord is not plugged into the wall outlet.
- We recommend installing a water filter if your water supply has sand or particles that could clog the screen of the refrigerator's water valve. Install it in the water line near the refrigerator. If using GE SmartConnect™ Refrigerator Tubing kit, you will need an additional tube (WX08X10002) to connect the filter. Do not cut plastic tube to install filter.

Remove the access cover.

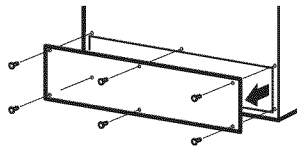

Remove the plastic flexible cap from the water valve (refrigerator connection).

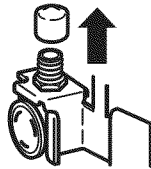

Place the compression nut and ferrule (sleeve) onto the end of the tubing as shown. On GE SmartConnect™ Refrigerator Tubing kit, the nuts are already assembled to the tubing.

Insert the end of the tubing into the water valve connection as far as possible. While holding the tubing, tighten the fitting.

For plastic tubing from a GE SmartConnect™ Refrigerator Tubing kit, insert the molded end of the tubing into the shutoff valve and tighten compression nut until it is hand tight, then tighten one additional turn with a wrench. Overtightening may cause leaks.

Fasten the tubing into the clamp provided to hold it in a vertical position. You may need to pry open the clamp.

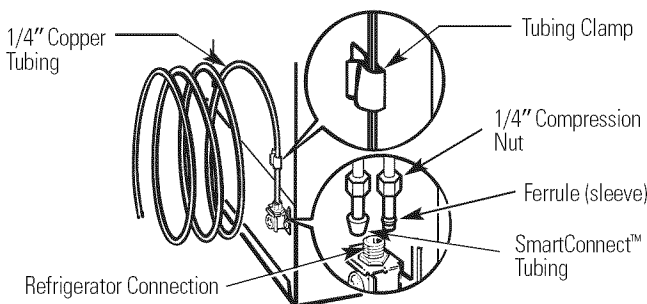

Reattach the access cover.

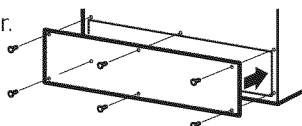

8 TURN THE WATER ON AT THE SHUTOFF VALVE

Tighten any connections that leak.

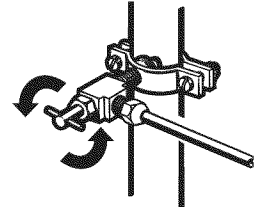

9 PLUG IN THE REFRIGERATOR

Arrange the coil of tubing so that it does not vibrate against the back of the refrigerator or against the wall. Push the refrigerator back to the wall.

10 START THE ICEMAKER

On power switch models, set the icemaker power switch to the **ON** position. On feeler arm models, move the feeler arm to the **ON** (down) position. The icemaker will not begin to operate until it reaches its operating temperature of 15°F (-9°C) or below. It will then begin operation automatically.

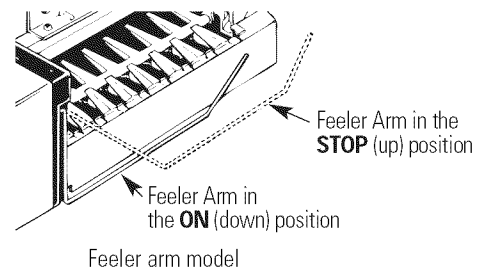
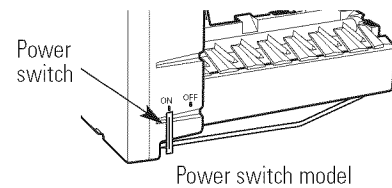

NOTE: In lower water pressure conditions, the water valve may turn on up to 3 times to deliver enough water to the icemaker.

Installation Instructions

2 REVERSING THE DOOR SWING

IMPORTANT NOTES

When reversing the door swing:

- Read the instructions all the way through before starting.
- Handle parts carefully to avoid scratching paint.
- Set screws down by their related parts to avoid using them in the wrong places.
- Provide a non-scratching work surface for the doors.

IMPORTANT: Once you begin, do not move the cabinet until door-swing reversal is completed.

These instructions are for changing the hinges from the right side to the left side—if you ever want to change the hinges back to the right side, follow these same instructions and reverse all references to left and right.

TOOLS REQUIRED

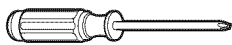

Phillips screwdriver

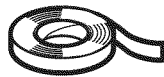

Masking tape



5/16" hex-head socket driver



T20 or T25 Torxdriver (needed for some models)

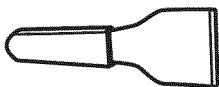

Putty knife or thin-blade screwdriver



5/16" open-end wrench

1 BEFORE YOU START

1.1 Unplug the refrigerator from its electrical outlet.

1.2 Empty all door shelves, including the dairy compartment.

CAUTION: Do not let either door drop to the floor. To do so could damage the door stop.

2 REMOVE THE FREEZER DOOR

2.1 Tape the door shut with masking tape.

2.2 With a 5/16" hex-head socket driver, remove the screws that hold the top hinge to the cabinet.

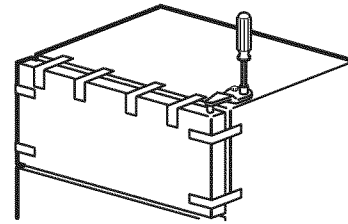

2.3 Lift the hinge straight up to free the hinge pin from the socket in the top of the door and set it aside, along with its screws.

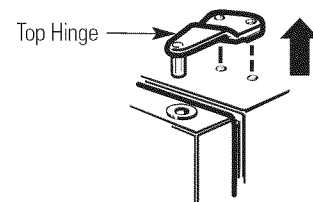

2.4 Remove the tape and tilt the door away from the cabinet. Lift it off the center hinge pin.

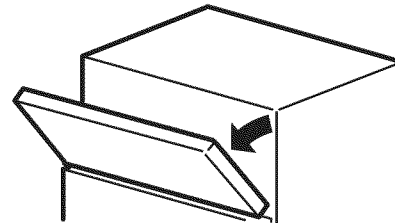

2.5 Set the door on a non-scratching surface with the outside up.

2.6 Transfer the 2 screws from the opposite side of the cabinet to the screw holes vacated by the top hinge removal.

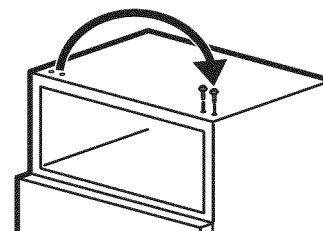

Installation Instructions

2 REVERSING THE DOOR SWING (CONT.)

3 REMOVE THE FRESH FOOD DOOR

3.1 Tape the door shut with masking tape.

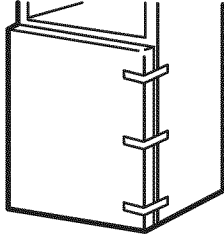

3.2 Using a 5/16" hex-head socket screwdriver and a 5/16" open-end wrench, remove the two screws holding the center hinge to the cabinet. Lift the center hinge to free its pin from the socket in the top of the door, and set hinge and screws aside. **Be careful not to lose the center hinge spacer and washer.**

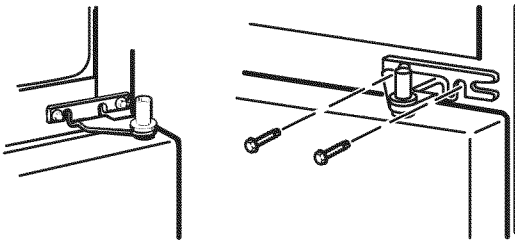

3.3 Remove the tape and tilt the door away from the cabinet. Lift the door from the pin in the bottom hinge bracket. (If the plastic washer sticks to the door bottom, put it back on the hinge.)

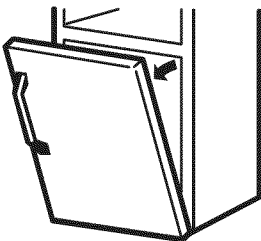

3.4 Set the door outside-up on a non-scratching surface.

3 REMOVE THE FRESH FOOD DOOR (CONT.)

3.5 Transfer the two screws from the opposite side of the cabinet to the screw holes vacated by the center hinge removal.

3.6 Transfer the washer (if your model has one) to the opposite side.

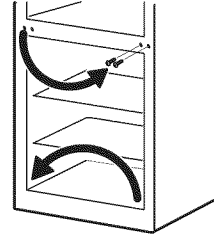

3.7 Take one of the screws removed in step 2 and start it in the outermost screw hole on the opposite side. Do not drive it all the way down—leave enough space under the screw head for thickness of the bracket.

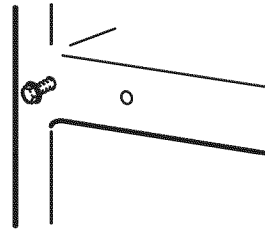

4 REVERSING THE HARDWARE

4.1 Move the bottom hinge bracket and plastic washer from the right side to the left side.

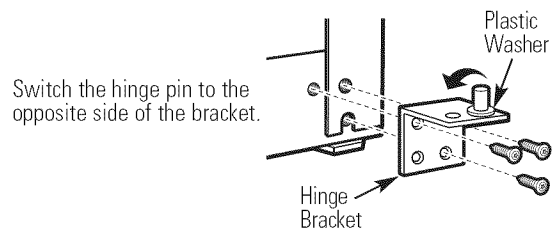

Installation Instructions

4 REVERSING THE HARDWARE (CONT.)

4.2 Interchange hinge and screws at top right with screws at top left of cabinet. **Do not tighten screws on hinge side at this time.**

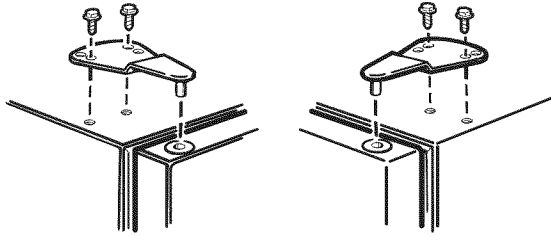

Installing the hinge on the left. Installing the hinge on the right.

NOTES:

- Some hinges have four holes. Which holes you use for installing the hinge depends on which side you install the hinge.
- The outer edge of the hinge should be parallel to the edge of the case for correct installation.

5 REVERSING THE DOOR HANDLES

5.1 Transfer fresh food door handle

5.1.1 Remove the handle plug using a tape-tipped putty knife under the edge, and remove the screw underneath. Remove the two screws holding the handle to the top of the door.

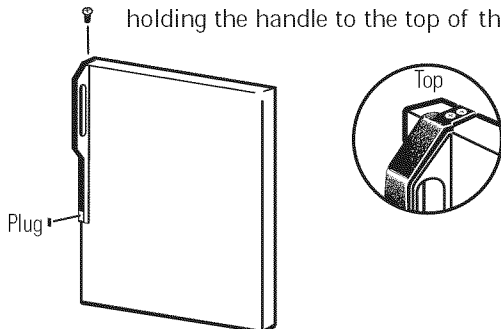

5.1.2 Remove the handle.

5 REVERSING THE DOOR HANDLES (CONT.)

5.1.3 Remove plug button from the top hinge hole on the left side of the door and insert it into the hole on the opposite side that was vacated by removal of the top hinge.

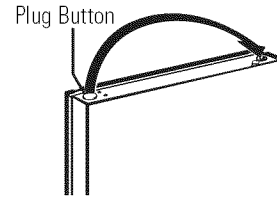

5.1.4 Pull the plug button from the front of the door and transfer it to the opposite side.

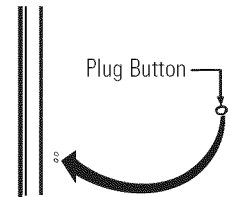

To reattach the handle on the opposite side.

5.2 Transfer door stop

5.2.1 Move the plastic door stop and screws from the right side to the left side.

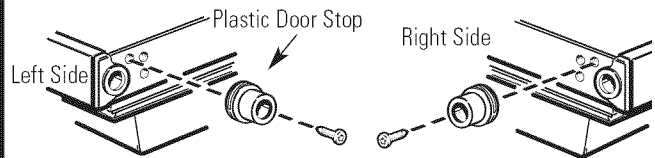

5.2.2 Move the metal door stop from the right side to the left side and transfer the screw to the opposite side of the door.

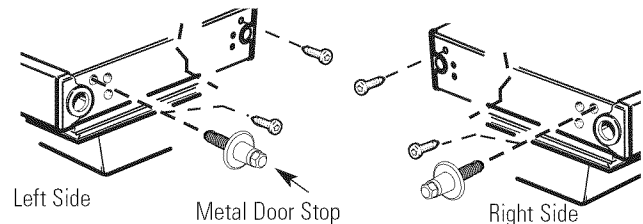

5.3 Reinstall the fresh food door handle

5.3.1 Attach the handle to the right side of the door with screws at the top and under the handle plug.

5.3.2 Reinstall the handle plug.

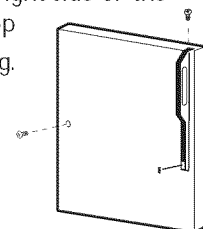

Installation Instructions

2 REVERSING THE DOOR SWING (CONT.)

5 REVERSING THE DOOR HANDLES (CONT.)

5.4 Transfer Freezer Door Handle

5.4.1 Remove the screw holding the handle to the top of the door and the two screws holding the handle to the bottom of the door.

5.4.2 Remove the handle.

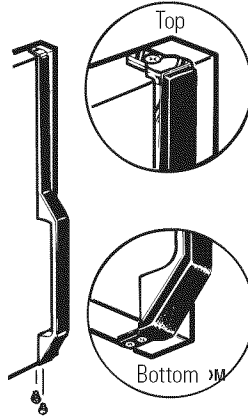

5.4.3 Remove the screw from the right top edge of the door and insert it into the handle screw hole on the left side.

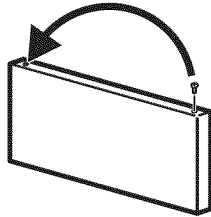

5.4.4 Transfer the door stop as shown in preceding section 5.2.

5.4.5 Attach the handle to the right edge of the door with screws at top and bottom, using bottom holes vacated by removal of the door stop screws.

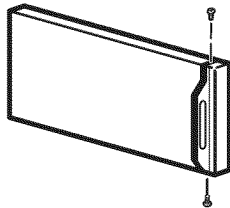

6 RE-HANGING THE DOORS

6.1 Re-hang the fresh food door

6.1.1 Lower the fresh food door onto the bottom hinge pin. **Be sure the washer is in place on the pin.**

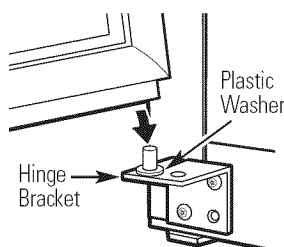

6 RE-HANGING THE DOORS (CONT.)

6.1.2 Insert the pin on the center hinge into the socket in the top of the door. Place the spacer, then the washer, on the hinge pin.

NOTE: The center hinge must be turned over as shown when mounted on the left side.

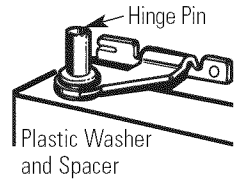

6.1.3 Tilt the door toward the cabinet. As the door is brought into position, slide the hinge under the head of the screw which earlier had been partly driven into the outermost hole. Insert the remaining screw, then tighten both screws securely.

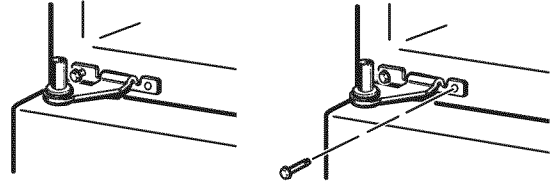

6.2 Re-hang the freezer door

6.2.1 Lower the freezer door onto the center hinge pin. **Be sure the washer and spacer are in place on the pin.**

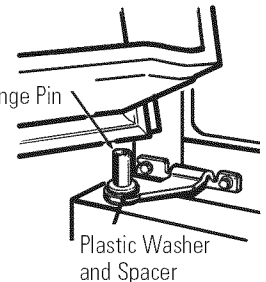

6.2.2 Tilt the door toward the cabinet, lifting the top hinge so the pin fits into the socket on the top of the door.

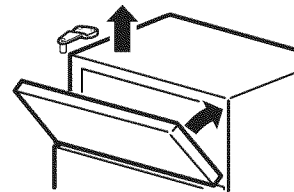

6.2.3 Make sure the door is slightly above the top of the cabinet and the gap between the doors is even across the front. Tighten the top hinge screws. Do not overtighten these screws—tighten them until they are just snug, then turn them another one-half turn.

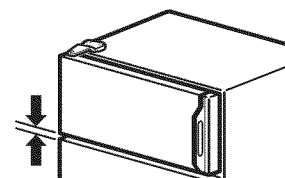



Newer refrigerators sound different from older refrigerators. Modern refrigerators have more features and use newer technology.

Do you hear what I hear? These sounds are normal.

- The new high efficiency compressor may run faster and longer than your old refrigerator and you may hear a high-pitched hum or pulsating sound while it is operating.
- You may hear a whooshing sound when the doors close. This is due to pressure equalizing within the refrigerator.

**HUMMM...
WHOOSH...**

WHIR!



- You may hear the fans spinning at high speeds. This happens when the refrigerator is first plugged in, when the doors are opened frequently or when

a large amount of food is added to the refrigerator or freezer compartments. The fans are helping to maintain the correct temperatures.

CLICKS, POPS, CRACKS and CHIRPS

- You may hear cracking or popping sounds when the refrigerator is first plugged in. This happens as the refrigerator cools to the correct temperature.
- The compressor may cause a clicking or chirping sound when attempting to restart (this could take up to 5 minutes).
- Expansion and contraction of cooling coils during and after defrost can cause a cracking or popping sound.
- On models with an icemaker, after an icemaking cycle, you may hear the ice cubes dropping into the ice bucket.



WATER SOUNDS

- The flow of refrigerant through the freezer cooling coils may make a gurgling noise like boiling water.
- Water dropping on the defrost heater can cause a sizzling, popping or buzzing sound during the defrost cycle.
- A water dripping noise may occur during the defrost cycle as ice melts from the evaporator and flows into the drain pan.
- Closing the door may cause a gurgling sound due to pressure equalization.



For additional information on normal icemaker operating sounds, see the **About the automatic icemaker** section.

Before you call for service...



Troubleshooting Tips
Save time and money! Review the charts on the following pages first and you may not need to call for service.

Problem	Possible Causes	What To Do
Refrigerator does not operate	Refrigerator in defrost cycle.	• Wait about 30 minutes for defrost cycle to end.
	Temperature control dial in OFF position.	• Move the temperature control dial to a temperature setting.
	Refrigerator is unplugged.	• Push the plug completely into the outlet.
	The fuse is blown/circuit breaker is tripped.	• Replace fuse or reset the breaker.
Vibration or rattling (slight vibration is normal)	Roller screws or leveling legs need adjusting.	• See Rollers and Leveling Legs.
Fresh food or freezer compartment too warm	Temperature control dial not set cold enough.	• See About the temperature control dial.
	Warm weather or frequent door openings.	• Set the temperature control dial one step colder. See About the temperature control dial.
	Door left open.	• Check to see if package is holding door open.
	Package blocking air duct in freezer compartment.	• Check to see if package is blocking air duct in freezer compartment.

Before you call for service...



Troubleshooting Tips

Problem	Possible Causes	What To Do
Motor operates for long periods or cycles on and off frequently. (Modern refrigerators with more storage space and a larger space and a larger freezer require more operating time. They start and stop often to maintain even temperatures.)	Normal when refrigerator is first plugged in.	<ul style="list-style-type: none"> • Wait 24 hours for the refrigerator to completely cool down.
	Often occurs when large amounts of food are placed in refrigerator.	<ul style="list-style-type: none"> • This is normal.
	Door left open.	<ul style="list-style-type: none"> • Check to see if package is holding door open.
	Hot weather or frequent door openings.	<ul style="list-style-type: none"> • This is normal.
	Temperature control dial set at the coldest setting.	<ul style="list-style-type: none"> • See About the temperature control dial.
	Grille and condenser need cleaning.	<ul style="list-style-type: none"> • See Care and cleaning.
Frost or ice crystals on frozen food (frost within package is normal)	Door left open.	<ul style="list-style-type: none"> • Check to see if package is holding door open.
	Too frequent or too long door openings.	
Automatic icemaker does not work (on some models)	Icemaker is not on.	<ul style="list-style-type: none"> • Move the feeler arm to the ON (down) position, or move the power switch to the ON position
	Water supply turned off or not connected.	<ul style="list-style-type: none"> • See Installing the water line.
	Freezer compartment too warm.	<ul style="list-style-type: none"> • Wait 24 hours for the refrigerator to completely cool down.
	Piled up cubes in the storage bin cause the icemaker to shut off.	<ul style="list-style-type: none"> • Level cubes by hand.
Frequent "buzzing" sound	Icemaker is on but the water supply to the refrigerator has not been connected	<ul style="list-style-type: none"> • Move the feeler arm to the STOP (up) position, or move the power switch to the OFF position, Keeping it on will damage the water valve..
Cubes too small	Water shutoff valve connecting refrigerator to water line may be clogged.	<ul style="list-style-type: none"> • Call the plumber to clear the valve.
Slow ice cube freezing	Door left open.	<ul style="list-style-type: none"> • Check to see if package is holding door open.
	Temperature control dial not set cold enough.	<ul style="list-style-type: none"> • See About the temperature control dial.
Ice cubes have odor/taste	Ice storage bin needs cleaning.	<ul style="list-style-type: none"> • Empty and wash bin. Discard old cubes.
	Food transmitting odor/taste to ice cubes.	<ul style="list-style-type: none"> • Wrap foods well.
	Interior of refrigerator needs cleaning.	<ul style="list-style-type: none"> • See Care and cleaning.
Moisture forms on cabinet surface between the doors	Not unusual during periods of high humidity.	<ul style="list-style-type: none"> • Wipe surface dry and reset temperature control dial one setting colder.
Moisture collects inside (in humid weather, air carries moisture into refrigerator when doors re opened)	Too frequent or too long door openings.	
Refrigerator has odor	Foods transmitting odor to refrigerator.	<ul style="list-style-type: none"> • Foods with strong odors should be tightly wrapped. • Keep an open box of baking soda in the refrigerator; replace every three months.
	Interior needs cleaning.	<ul style="list-style-type: none"> • See Care and cleaning.

Refrigerator Warranty. (For customers in the United States)

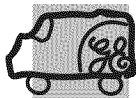

All warranty service provided by our Factory Service Centers, or an authorized Customer Care® technician. To schedule service, on-line, 24 hours a day, visit us at GEAppliances.com, or call 800.GE.CARES (800.432.2737). Please have serial number and model number available when calling for service.

Staple your receipt here. Proof of the original purchase date is needed to obtain service under the warranty.

For The Period Of: GE Will Replace:

GE and GE PROFILE MODELS:

<p>One Year From the date of the original purchase</p>	<p>Any part of the refrigerator which fails due to a defect in materials or workmanship. During this limited one-year warranty, GE will also provide, free of charge, all labor and related service to replace the defective part.</p>
<p>Thirty Days (Water filter, if included) From the original purchase date of the refrigerator</p>	<p>Any part of the water filter cartridge which fails due to a defect in materials or workmanship. During this limited thirty-day warranty, GE will also provide, free of charge, a replacement water filter cartridge.</p>

GE PROFILE MODELS ONLY:

<p>Five Years (GE Profile models only) From the date of the original purchase</p>	<p>Any part of the sealed refrigerating system (the compressor, condenser, evaporator and all connecting tubing) which fails due to a defect in materials or workmanship. During this limited five-year sealed refrigerating system warranty, GE will also provide, free of charge, all labor and related service to replace the defective part in the sealed refrigerating system.</p>
---	---

What GE Will Not Cover:

- Service trips to your home to teach you how to use the product.
- Improper installation, delivery or maintenance.
- Failure of the product if it is abused, misused, or used for other than the intended purpose or used commercially.
- Loss of food due to spoilage.
- Replacement of house fuses or resetting of circuit breakers.
- Damage caused after delivery.
- Products which are not defective, broken or which are working as described in the Owner's manual.
- Replacement of the water filter cartridge, if included, due to water pressure that is outside the specified operating range or due to excessive sediment in the water supply.
- Replacement of the light bulbs, if included, or water filter cartridge, if included, other than as noted above.
- Damage to the product caused by accident, fire, floods or acts of God.
- Incidental or consequential damage caused by possible defects with this appliance.
- Product not accessible to provide required service.

EXCLUSION OF IMPLIED WARRANTIES—Your sole and exclusive remedy is product repair as provided in this Limited Warranty. Any implied warranties, including the implied warranties of merchantability or fitness for a particular purpose, are limited to one year or the shortest period allowed by law.

This warranty is extended to the original purchaser and any succeeding owner for products purchased for home use within the USA. If the product is located in an area where service by a GE Authorized Servicer is not available, you may be responsible for a trip charge or you may be required to bring the product to an Authorized GE Service location for service. In Alaska, the warranty excludes the cost of shipping or service calls to your home.

Some states do not allow the exclusion or limitation of incidental or consequential damages. This warranty gives you specific legal rights, and you may also have other rights which vary from state to state. To know what your legal rights are, consult your local or state consumer affairs office or your state's Attorney General.

Consumer Support.



GE Appliances Website

GEAppliances.com

In the U.S.: **www.Hotpoint.com**

Have a question or need assistance with your appliance? Try the GE Appliances Website 24 hours a day, any day of the year! For greater convenience and faster service, you can now download Owner's Manuals, order parts, or even schedule service on-line. **In Canada: www.geappliances.ca**

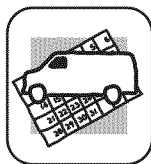

Schedule Service

GEAppliances.com

In the U.S.: **www.Hotpoint.com**

Expert GE repair service is only one step away from your door. Get on-line and schedule your service at your convenience 24 hours any day of the year! Or call 800.GE.CARES (800.432.2737) during normal business hours.

In Canada, call 1.800.561.3344

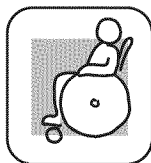

Real Life Design Studio

In the U.S.: **GEAppliances.com**

GE supports the Universal Design concept—products, services and environments that can be used by people of all ages, sizes and capabilities. We recognize the need to design for a wide range of physical and mental abilities and impairments. For details of GE's Universal Design applications, including kitchen design ideas for people with disabilities, check out our Website today. For the hearing impaired, please call 800.TDD.GEAC (800.833.4322).

In Canada, contact: Manager, Consumer Relations, Mabe Canada Inc.
Suite 310, 1 Factory Lane
Moncton, N.B. E1C 9M3



Extended Warranties

In the U.S.: **GEAppliances.com**

Purchase a GE extended warranty and learn about special discounts that are available while your warranty is still in effect. You can purchase it on-line anytime, or call 1.888.261.2133 during normal business hours. GE Consumer Home Services will still be there after your warranty expires.

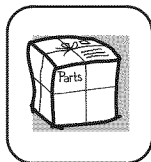

Parts and Accessories

GEAppliances.com

In the U.S.: **www.Hotpoint.com**

Individuals qualified to service their own appliances can have parts or accessories sent directly to their homes (VISA, MasterCard and Discover cards are accepted). Order on-line today, 24 hours every day or by phone at 1.800.661.1616 during normal business hours.

Instructions contained in this manual cover procedures to be performed by any user. Other servicing generally should be referred to qualified service personnel. Caution must be exercised, since improper servicing may cause unsafe operation. Customers **in Canada** should consult the yellow pages for the nearest Mabe service center, or call 1.800.661.1616.



Contact Us

GEAppliances.com

In the U.S.: **www.Hotpoint.com**

If you are not satisfied with the service you receive from GE, contact us on our Website with all the details including your phone number, or write to:

General Manager, Customer Relations
GE Appliances, Appliance Park
Louisville, KY 40225

In Canada: www.geappliances.ca, or write to: Director, Consumer Relations, Mabe Canada Inc.
Suite 310, 1 Factory Lane
Moncton, N.B. E1C 9M3



Register Your Appliance

GEAppliances.com

In the U.S.: **www.Hotpoint.com**

Register your new appliance on-line—at your convenience! Timely product registration will allow for enhanced communication and prompt service under the terms of your warranty, should the need arise. You may also mail in the pre-printed registration card included in the packing material.

In Canada: www.geappliances.ca