

This Owner's Manual is provided and hosted by [Appliance Factory Parts](#).



LG LMAN127HVT Owner's Manual

[Shop genuine replacement parts for LG LMAN127HVT](#)



[Find Your LG Air Conditioner Parts - Select From 2328 Models](#)

----- Manual continues below -----



Internal Use Only

<http://biz.lgservice.com>

Wall Mounted Air Conditioner **SVC MANUAL(Exploded View)**

**MODEL : AMNW09GDBR1 [LMAN097HVT]
AMNW12GDBR1 [LMAN127HVT]**

CAUTION

Before Servicing the unit, read the safety precautions in General SVC manual.
Only for authorized service personnel.

1. Specification

Model			AMNW09GDBR1 [LMAN097HVT]	AMNW12GDBR1 [LMAN127HVT]
Power Supply		Ø, V, Hz	1, 208/230, 60	1, 208/230, 60
Capacity(*)		Btu/h Class	9,000	12,000
Current	Running Current	A	0.2	0.2
Fan	Motor Type		BLDC	BLDC
	Fan Type		Cross Flow Fan	Cross Flow Fan
	Motor Output(W) x No. of Unit		14.4 x 1	14.4 x 1
	Air Flow Rate (H / M / L)	CMM	7 / 6.5 / 6	9.5 / 9 / 8.5
		CFM	247/230/212	336/318/300
	External Static Pressure	mmAq	-	-
	Capacitor	µF / Vac	-	-
Drive		Direct Drive	Direct Drive	
Coil	Row x Column x FPI		2R x 16C x 23	2R x 16C x 23
Dimensions (W x H x D)	Body	mm	895 x 289 x 205	895 x 289 x 205
		inch	35-1/4 x 11-3/8 x 8-1/16	35-1/4 x 11-3/8 x 8-1/16
	Decorative Panel	mm	-	-
		inch	-	-
Net Weight	Body	kg (lbs)	10.2(22.5)	10.2(22.5)
	Decorative Panel	kg (lbs)	-	-
Air Filter			Long Life Filter	Long Life Filter
Sound Level (H / M / L)		dB(A)+3	33 / 30 / 27	39 / 36 / 31
Piping	Liquid	mm (inch)	6.35 (1/4)	6.35 (1/4)
Connections	Gas	mm (inch)	9.52 (3/8)	9.52 (3/8)
	Drain(OD/ID)	mm(inch)	21.5/16 (0.846/0.630)	21.5/16 (0.846/0.630)
Dehumidification Rate		l/h	1.1	1.2
Safety Devices			Fuse, Thermal Protector for Fan Motor	
Temperature Sensor			Thermistor	Thermistor
Refrigerant			R410A	R410A
Refrigerant Control			EEV(in Outdoor unit or BD)	EEV(in Outdoor unit or BD)
Transmission Interunit Cable		No. x AWG	4×18(including earth)	4×18(including earth)

Note:

- Capacities are based on the following conditions:
 Cooling: - Indoor Temperature 26.7°C DB/19.4°C WB
 - Outdoor Temperature 35°C DB/23.9°C WB
 Heating: - Indoor Temperature 21.1°C DB/15.4°C WB
 - Outdoor Temperature 8.3°C DB/6.1°C WB
 Piping Length - Interconnecting Piping Length 7.5m
 - Level Difference of Zero
- Wiring cable size must comply with the applicable local and national code.
- The specification may be subject to change without prior notice for purpose of improvement.

Conversion Formula
kW = Btu/h x 0.0002931
cfm = CMM x 35.3

2. Piping Diagrams

Indoor Unit

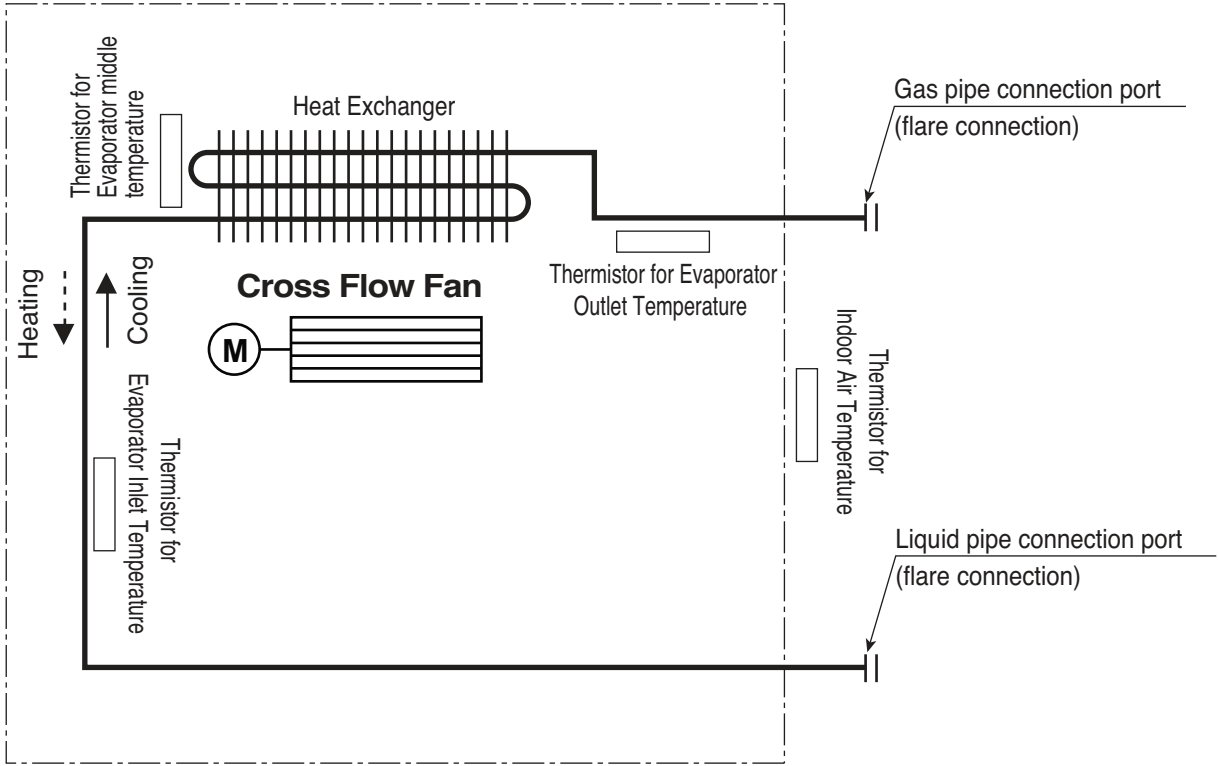

Description	PCB Connector
Thermistor for Indoor Air Temperature	CN_TH1
Thermistor for Evaporator Inlet Temperature	
Thermistor for Evaporator Outlet Temperature	CN_TH2

3. Wiring Diagrams

Indoor Unit

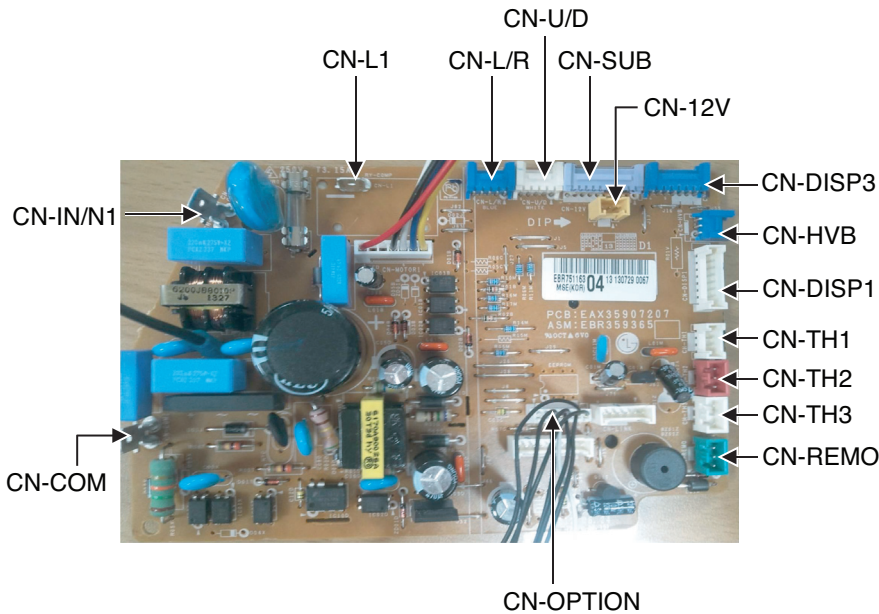
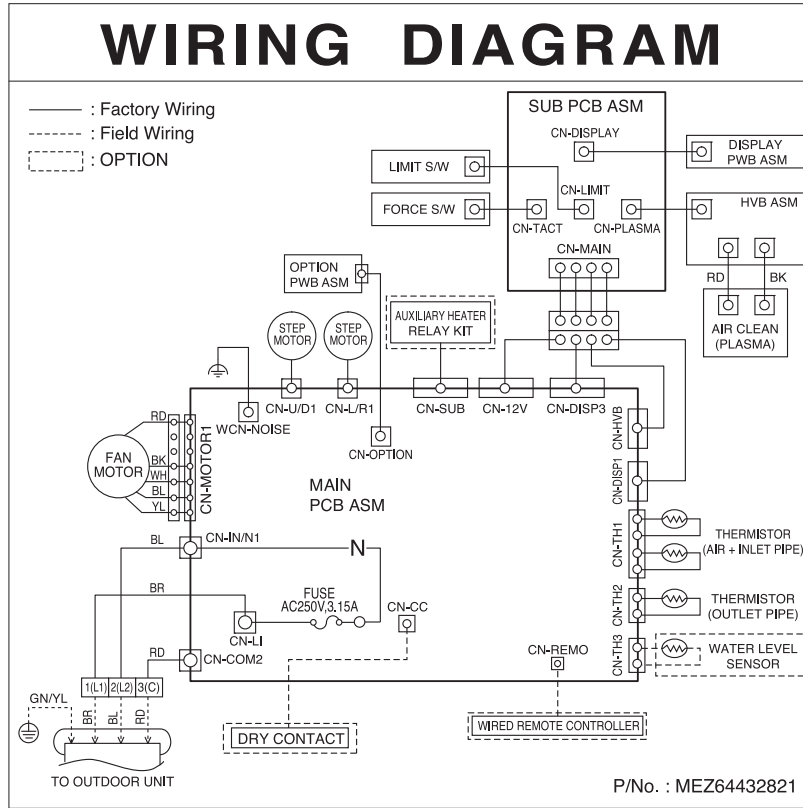

Main PCB

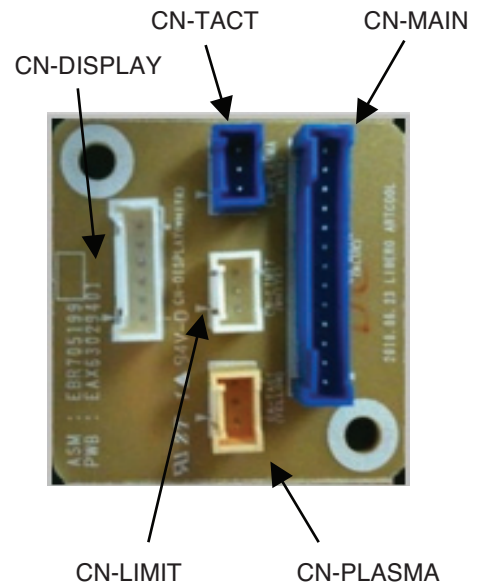

Sub PCB

4. Exploded View

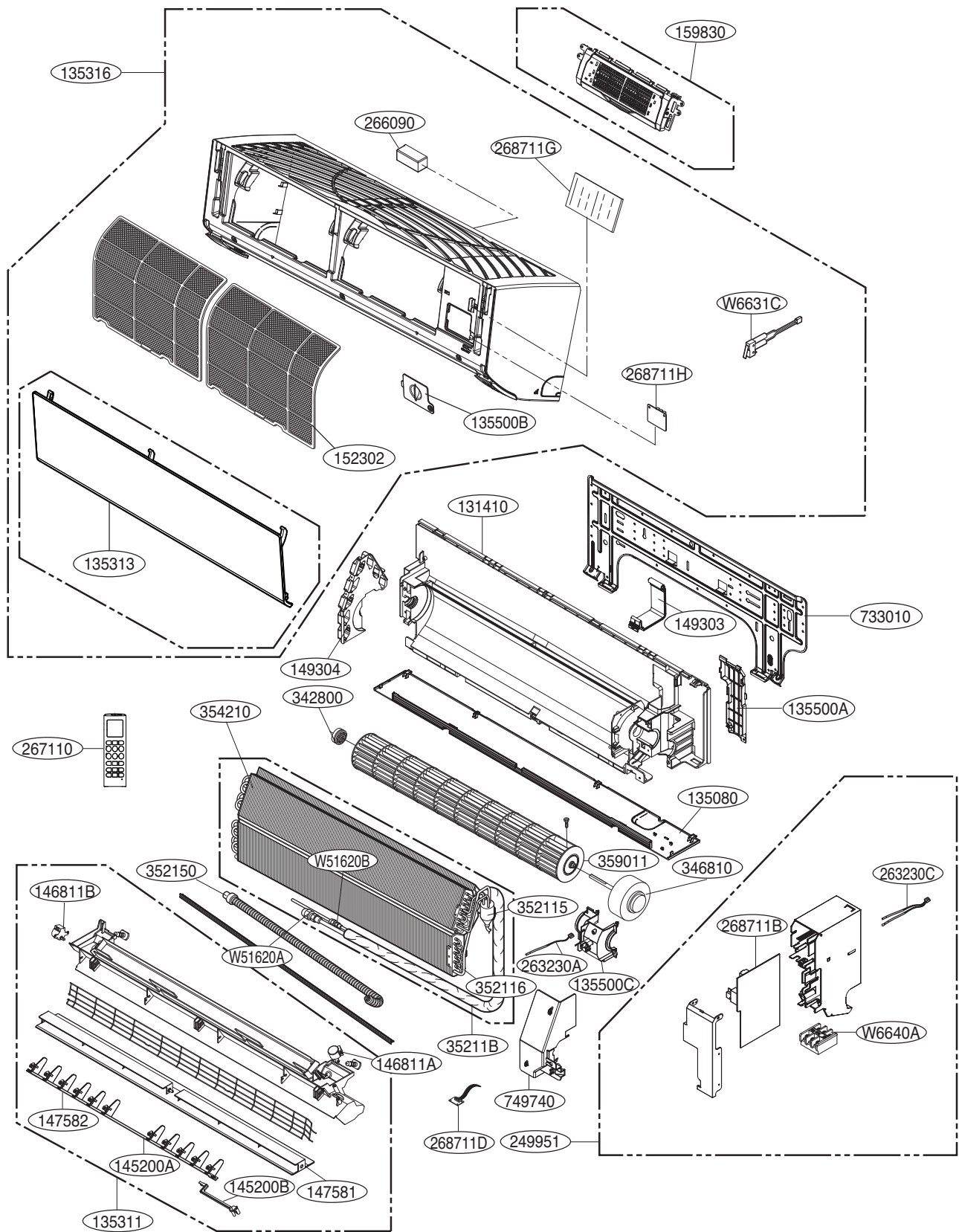



P/NO : MFL67482718

JANUARY, 2013