



Rebellion Electric Chopper Mini Electric Chopper



OWNERS MANUAL

Read and understand this entire manual before riding!

Item Numbers

Mini Electric Chopper

Black 15555-BK

Red 15555-RD

Blue 15555-BL

Rebellion Electric Chopper

15130760

CONTENTS

Safety Warnings	1	Mini Electric Chopper Parts	11-12
Before You Begin	2	Rebellion Electric Chopper Parts	13-14
Assembly and Set-Up	3-4	Safety Reminders	Back Cover
Repair and Maintenance	4-7	Warranty	Back Cover
Troubleshooting Guide	9-10		

SAFETY WARNINGS

! WARNING: Riding the electric chopper can be a hazardous activity. Certain conditions may cause the equipment to fail without fault of the manufacturer. Like other electric vehicles, the electric chopper can and is intended to move, and it is therefore possible to lose control, fall off and/or get into dangerous situations that no amount of care, instruction or expertise can eliminate. If such things occur you can be seriously injured or die, even when using safety equipment and other precautions. **RIDE AT YOUR OWN RISK AND USE COMMON SENSE.**

This manual contains many warnings and cautions concerning the consequences of failing to maintain, inspect or properly use your electric chopper. Because any incident can result in serious injury or even death, we do not repeat the warning of possible serious injury or death each time such a possibility is mentioned.

APPROPRIATE RIDER USE AND PARENTAL SUPERVISION

This manual contains important safety information. It is your responsibility to review this information and make sure that all riders understand all warnings, cautions, instructions and safety topics and assure that young riders are able to safely and responsibly use this product. Razor recommends that you periodically review and reinforce the information in this manual with younger riders, and that you inspect and maintain your children's vehicle to insure their safety.

The recommended rider ages of 12 and older for the Mini Electric Chopper and 14 and older for the Rebellion Electric Chopper are only estimates, and can be affected by the rider's size, weight or skills. Any rider unable to fit comfortably on the electric chopper should not attempt to ride it. A parent's decision to allow his or her child to ride this product should be based on the child's maturity, skill and ability to follow rules.

Keep this product away from small children and remember that this product is intended for use only by persons who are, at a minimum, completely comfortable and competent while operating the vehicle.

DO NOT EXCEED THE WEIGHT LIMIT OF 220 pounds. Rider weight does not necessarily mean a person's size is appropriate to fit or maintain control of the electric chopper.

Do not touch the motor on your electric chopper when in use as it can become very hot.

Refer to the section on safety for additional warnings.

ACCEPTABLE RIDING PRACTICES AND CONDITIONS

Always check and obey any local laws or regulations which may affect the locations where the electric chopper may be used on public property. The electric chopper is meant to be used only in controlled environments free of potential traffic hazards and not on public streets or sidewalks. Do not ride your electric chopper in any areas where pedestrian or vehicle traffic is present.

Ride defensively. Watch out for potential obstacles that could catch your wheel or force you to swerve suddenly or lose control. Be careful to avoid pedestrians, skaters, skateboards, scooters, bikes,

children or animals who may enter your path, and respect the rights and property of others.

Do not attempt or do stunts or tricks on your electric chopper. The electric chopper is not made to withstand abuse from misuse such as jumping, curb grinding or any other type of stunts.

Maintain a hold on the handlebars at all times.

Never carry passengers or allow more than one person at a time to ride the electric chopper.

Never use near steps or swimming pools.

Keep your fingers and other body parts away from the drive chain, steering system, wheels and all other moving components.

Never use headphones or a cell phone when riding.

Never hitch a ride with another vehicle.

Do not ride the electric chopper in wet weather and never immerse the electric chopper in water, as the electrical and drive components could be damaged by water or create other possibly unsafe conditions.

The electric chopper is intended for use on solid, flat, clean and dry surfaces such as pavement or level ground without loose debris such as rocks or gravel. Wet, slick or uneven and rough surfaces may impair traction and contribute to possible accidents. Do not drive the electric chopper in mud, ice, puddles or water. Avoid excessive speeds that can be associated with downhill rides. Never risk damaging surfaces such as carpet or flooring by use of an electric chopper indoors.

Do not ride at night or when visibility is impaired.

PROPER RIDING ATTIRE

Always wear proper protective equipment such as an approved safety helmet, elbow pads and kneepads. A helmet may be legally required by local law or regulation in your area. Always wear shoes, never drive barefooted or in sandals, and keep shoelaces tied and out of the way of the wheels, motor and drive system.

USING THE CHARGER

The charger supplied with the electric chopper should be regularly examined for damage to the cord, plug, enclosure and other parts, and in the event of such damage, the bike must not be charged until the charger has been repaired or replaced.

Use only with the recommended charger.

The charger is not a toy.

Always disconnect from the charger prior to wiping down and cleaning your electric chopper with liquid.

FAILURE TO USE COMMON SENSE AND HEED THE ABOVE WARNINGS INCREASES RISK OF SERIOUS INJURY. USE WITH APPROPRIATE CAUTION AND SERIOUS ATTENTION TO SAFE OPERATION.

BEFORE YOU BEGIN

Remove contents from box. Remove the foam separators that protect the components from damage during shipping. Inspect the contents of the box for scratches in the paint, dents or kinked cables that may have occurred during shipping. Because the electric chopper was 95 percent assembled and packed at the factory, there should not be any problems, even if the box has a few scars or dents.

Estimated Assembly and Set-Up Time

Razor recommends assembly by an adult with experience in bicycle mechanics. Allow up to 30 minutes for assembly, not including initial charge time. Allow up to 12 hours for initial charge (see page 3 for charging information).

⚠ WARNING:
DO NOT USE NON-RAZOR PRODUCTS WITH YOUR RAZOR ELECTRIC CHOPPER. The electric chopper has been built to certain Razor design specifications. The original equipment supplied at the time of sale was selected on the basis of its compatibility with the frame, fork and all other parts. Certain aftermarket products may or may not be compatible.

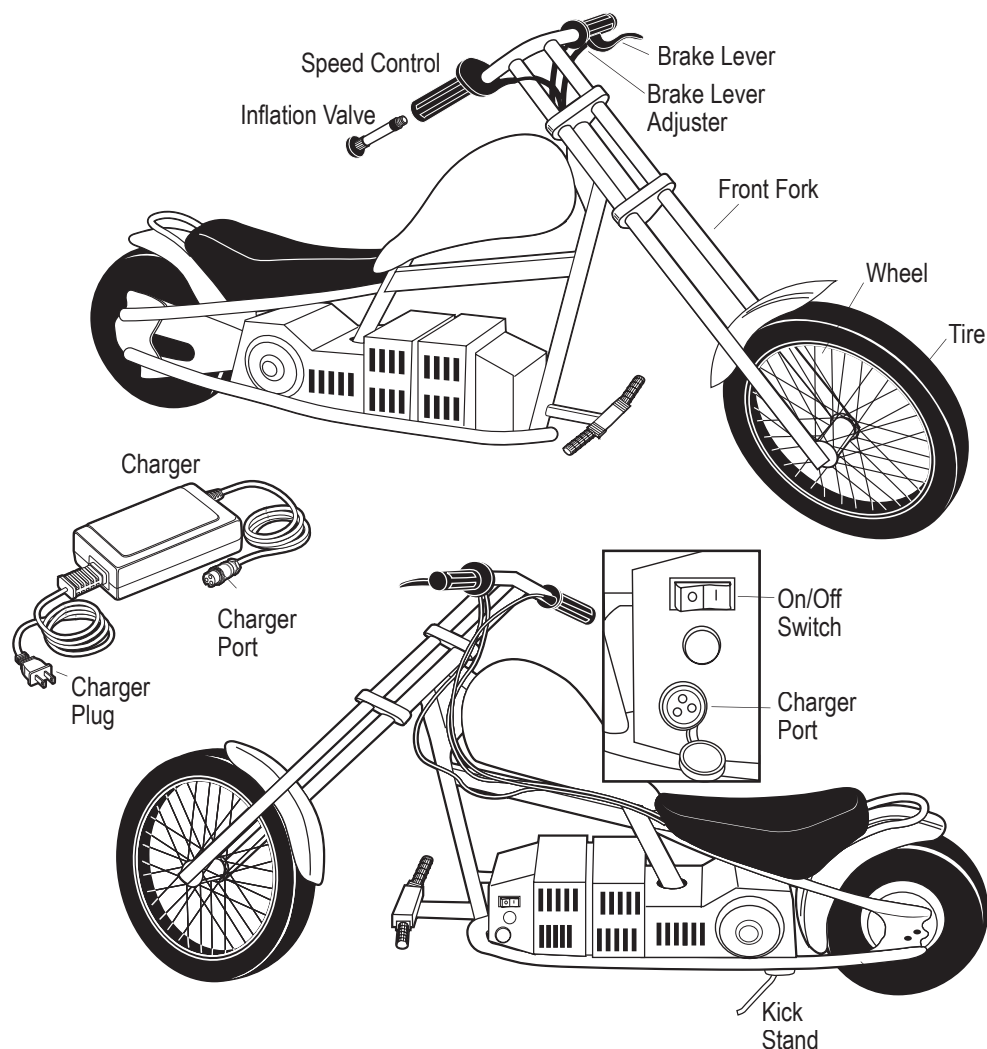

Required Tools

Some tools may be supplied; however, we recommend the use of mechanic's grade tools. Use the supplied tools only as a last resort.

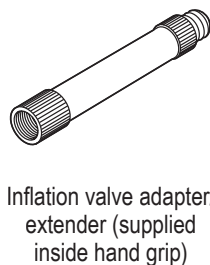
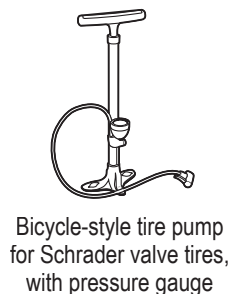
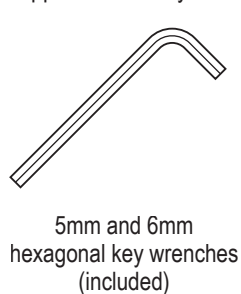

Need Help? Visit our web site for updates and a list of authorized service centers at www.razor.com or call toll-free at **866-467-2967** Monday - Friday 8:00 AM - 5:00 PM Pacific Time.

ASSEMBLY AND SET-UP

Charging the Battery

Your electric chopper may not have a fully charged battery. Therefore it is a good idea to charge the battery prior to use.

- Initial charge time: 12 hours
- Recharge time: up to 8 hours depending on the level of depletion.
- Run time: up to 40 minutes
- Average battery life: 250 charge/discharge cycles

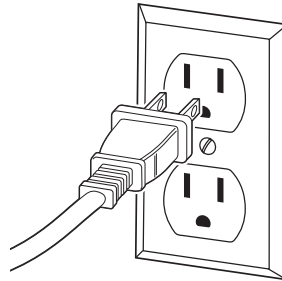
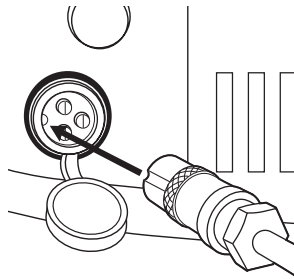
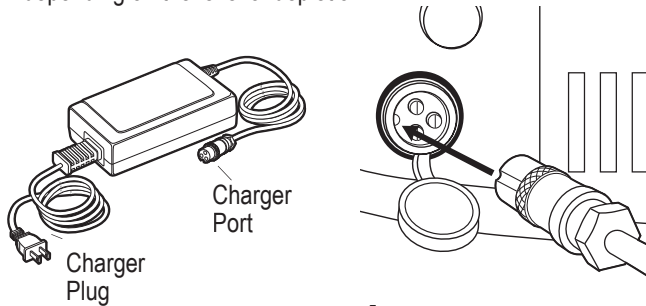

1 Plug the charger port into the port on the chopper. The charger works with the power switch in either the on or off position.

2 Plug the charger plug into a wall outlet.

⚠ WARNING: Always disconnect your electric chopper from the charger before cleaning with liquid.

Note: If your charger does not look like the one illustrated, your unit has been supplied with an alternative charger. The specifications and charging procedure would not change.

The charger has a small window with one LED or two LEDs to indicate the charge status. Refer to the illustration on the charger unit for the actual "charging" and "charged" status indications for your model charger.

Chargers have built-in over-charge protection to prevent battery from being over-charged.

Be sure to properly align the groove on the charger input plug with the corresponding socket on the case; otherwise, no charging action will occur.

Attaching the Front Forks

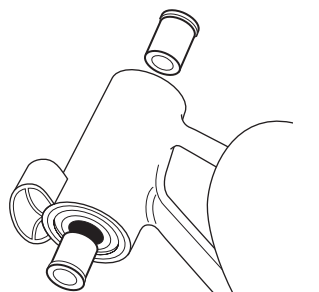
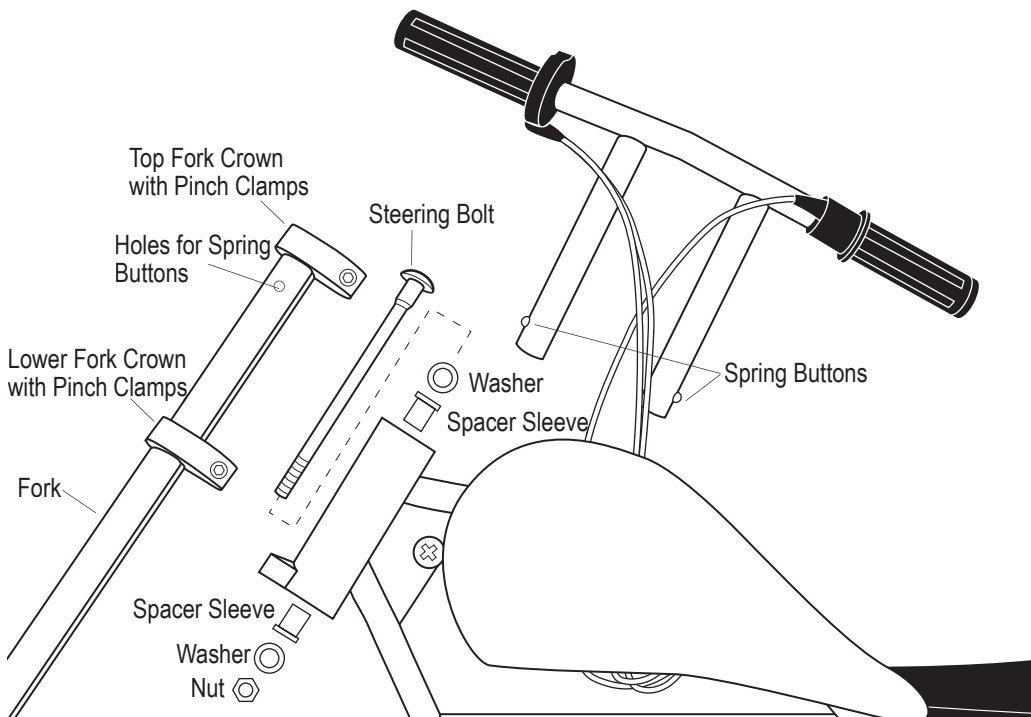

1 Insert the spacer sleeves on the top and bottom of the frame.

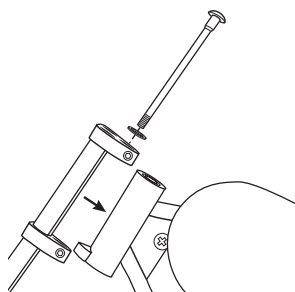

2 Slide the fork into position and insert the steering bolt. The bolt must go through the washer and spacer sleeve and between the steering bearings inside the frame.

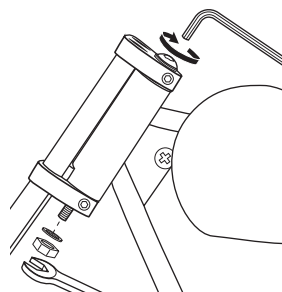

3 Install washer and nut onto steering bolt. Tighten until snug, then back off slightly to allow the steering to rotate freely with no binding or end-play.

⚠ WARNING: Failing to properly adjust and tighten the clamps and retainers that affix the forks can cause you to lose control and fall.

ASSEMBLY AND SET-UP

Attaching the Handlebars

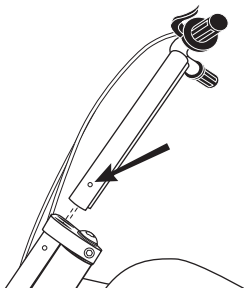

1 Press the spring buttons on each side of the handlebars and tap the bars until the spring buttons slide inside and engage the corresponding holes in the fork.

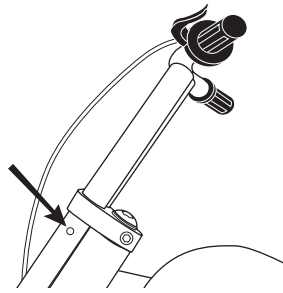

2 When correctly engaged, the handlebars will not disengage from the fork.

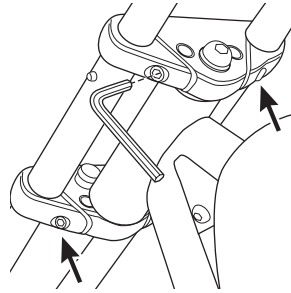

3 Tighten all four pinch clamp screws (two in the upper and two in the lower crown).

Testing the Brakes

To use the brake, squeeze the lever to increase the pressure on the brake. The brake lever is fitted with a cable adjuster to compensate for cable stretch and/or to fine-tune the lever movement to brake engagement. If brake is not engaging properly, follow instructions for adjusting the brakes outlined below.

REPAIR AND MAINTENANCE

Check the Razor web site for any updates on the latest repair and maintenance procedures. Turn power switch off before conducting any maintenance procedures.

Adjusting the Brakes

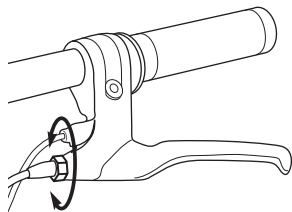

1 To adjust the play, thread the brake lever adjuster in or out 1/4 to 1/2 turn until the desired brake adjustment is attained. Most adjustments are complete at this step. If brake still needs further adjustment, proceed to step 2.

Mini Chopper

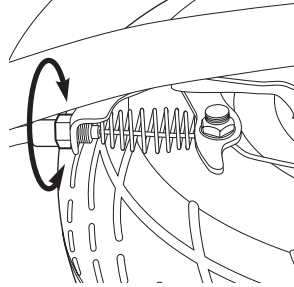

2 If the brake lever adjuster is threaded outward and the brake still has too much slack, use the rear brake adjuster for additional adjustment.

Rebellion Chopper

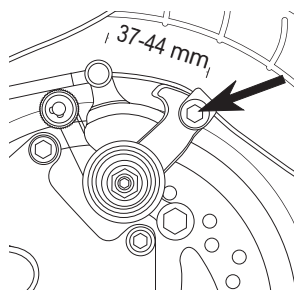

2 If the brake has too much slack, loosen the rear anchor bolt and pull the brake wire tighter. The distance of the brake wire between the end of the cable and the anchor bolt should be between 37-44 mm.

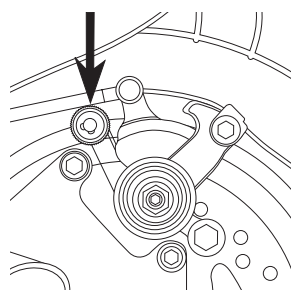

3 If the brake rotor is dragging on the brake pads use your fingers to twist the calliper adjuster in either direction until rotor is centered between pads.

⚠ WARNING: Failing to properly engage the spring buttons that affix the handlebars to the forks can cause you to lose control and fall.

Note: You may wish to ask another person for assistance, as it can be difficult to press both buttons and tap the handlebar into the fork at the same time. A rubber mallet is helpful to tap the bars into place, as the fit between the handlebar and fork can be snug.

⚠ WARNING: The brake is capable of skidding the tire and throwing an unsuspecting rider. Practice in an open area free from obstacles until you are familiar with the brake function. Avoid skidding to a stop as this can cause you to lose control or damage the rear tire.

Note: The brake lever contains a safety switch to stop the motor when the brake is applied. In an emergency, applying the brake will always stop the motor. Do not disable or replace this lever with anything other than a genuine Razor replacement part.

REPAIR AND MAINTENANCE

Inflating the Tires

Tires are inflated when shipped, but they invariably lose some pressure between the point of manufacturing and your purchase.

Rear Tire

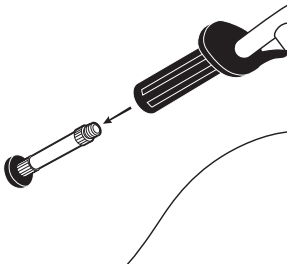

1 Use the special valve extender/adapter supplied. This item is concealed in the grip on the speed control side of the handlebar.

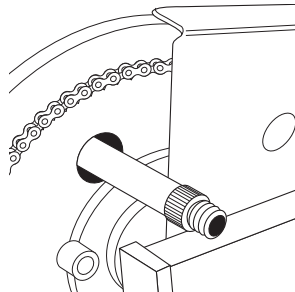

2 Align the access hole in the drive sprocket with the tire valve. Thread the adapter completely onto the valve and attach the pump. Inflate to the PSI indicated on the tire sidewall.

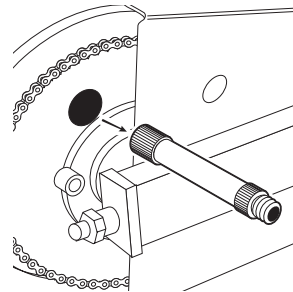

3 Remove valve adapter immediately after inflating.

⚠ WARNING: Failure to remove the valve adapter after inflating will cause the inner tube and/or adapter to be severed by the rear drive sprocket.

Note: If you lose the adapter, a valve stem extender can be purchased at almost any auto parts store.

Note: The pressurized air supplies found at gasoline stations are designed to inflate high-volume automobile tires. If you decide to use such an air supply to inflate your electric chopper tires, first make sure the pressure gauge is working, then use very short bursts to inflate to the correct PSI. If you inadvertently over-inflate the tire, release the excess pressure immediately.

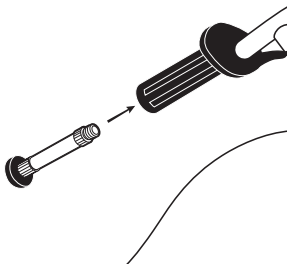

4 Place the adapter back into the handlebar grip for later use.

Front Tire

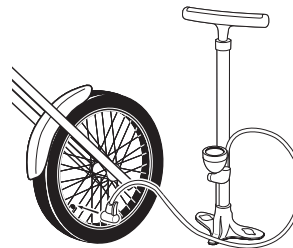

1 Using a bicycle style tire pump equipped for a Schrader-type valve, inflate the front tire to the PSI indicated on the sidewall of the tire.

Chain and Sprocket Adjustment – Mini Chopper

Note: Late model Mini Electric Choppers and Rebellion Electric Choppers are equipped with a chain tensioner, are self adjusting and will not use this method to adjust the chain.

The chain will typically have a “loose spot” and “tight spot” corresponding with a particular sprocket rotational position. This is normal and common to all chain-driven vehicles due to run-out tolerances of freewheel and sprocket.

The chain should be adjusted to the ideal tension with chain in the tightest spot.

Proper chain alignment must be maintained.

The wheel must not be skewed. If the chain is noisy or rough running, check the lubrication, tension and alignment of the sprockets, in that order.

If the wheel is skewed, follow steps on page 6 to align the wheel and adjust the chain.

REPAIR AND MAINTENANCE

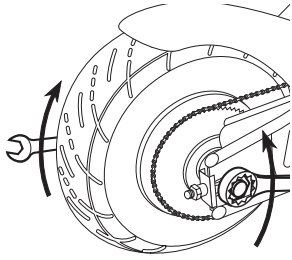

1 Loosen the rear axle by attaching wrenches to both axle nuts and loosening counter-clockwise.

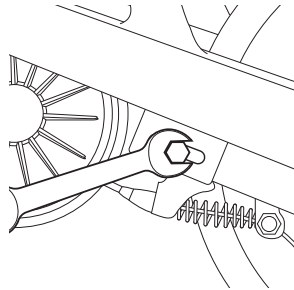

2 Loosen the brake anchor screw (attached with the small bolt in the long slot on the left side of the frame).

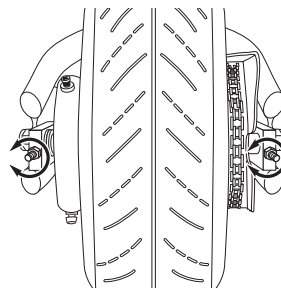

3 Tightening the adjusters clockwise tightens the chain; loosening the adjusters counter-clockwise will relax it. When loosening the adjusters, you will have to nudge the axle forward by tapping the wheel with your hand to relax the tension on the chain.

⚠ WARNING: To avoid a pinch or injury, keep fingers away from moving sprockets and chain.

⚠ WARNING: Increasing the tension too much can snap the chain or bend the motor output shaft. To avoid this, use caution when tightening and carefully check the tension after each 1/8 to 1/4 turn of adjusters.

Note: This system of adjusters is common to motorcycles and BMX bicycles. If you are not familiar with it or do not feel comfortable performing the adjustment, consult an authorized Razor service center or a qualified BMX bike or motorcycle mechanic.

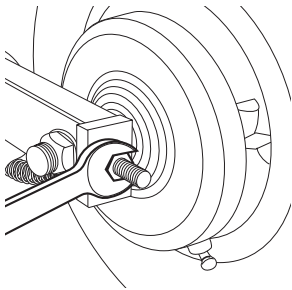

4 Turn both adjusters the exact same amount, 1/8 to 1/4 turn at a time, to maintain the wheel alignment. Once the tension is correct, tighten the axle and brake anchor bolt.

Chain and Tire Replacement – Mini Chopper

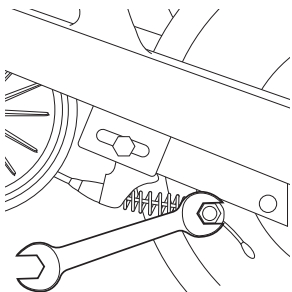

1 Loosen and disconnect the brake cable anchor.

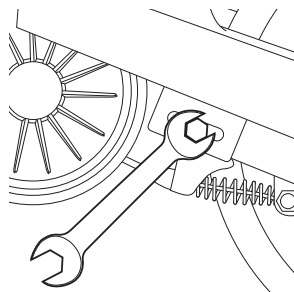

2 Loosen and disconnect the brake housing anchor. **Note:** Pay attention to the location of the parts for when you reinstall.

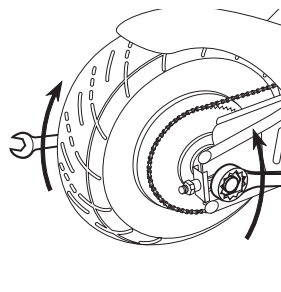

3 Loosen the rear axle by attaching wrenches to both axle nuts and loosening counter-clockwise.

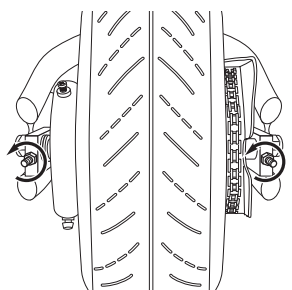

4 Loosen the chain adjusters about 3-4 turns. Be sure to loosen both adjusters an equal number of turns.

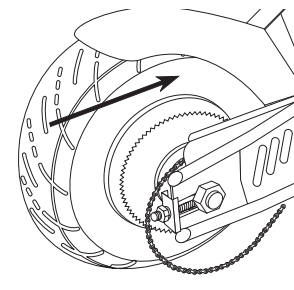

5 Slide the wheel forward to slacken and disengage the chain from the wheel sprocket and motor sprocket.

(Note: Your hands will get greasy doing this.)

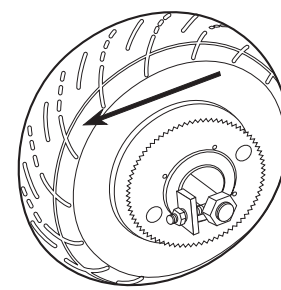

6 Remove wheel and replace chain or tire. To reinstall wheel, reverse these steps.

REPAIR AND MAINTENANCE

Chain and Tire Replacement – Rebellion Chopper

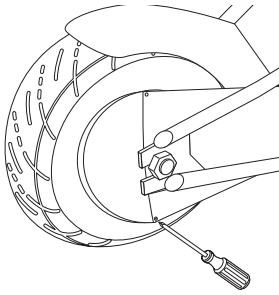

1 Loosen screw and remove chain guard.

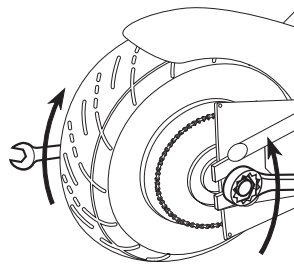

2 Loosen the rear axle by attaching wrenches to both axle nuts and loosening counter-clockwise.

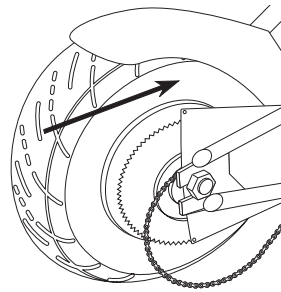

3 Slide the wheel forward to slacken the chain and disengage the chain from the wheel sprocket and motor sprocket.

(Note: Your hands will get greasy doing this.)

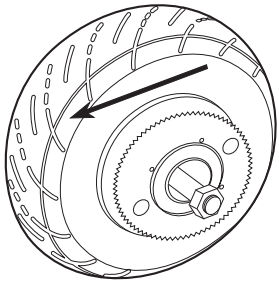

4 Remove wheel and replace chain or tire. To reinstall wheel, reverse these steps.

Battery Care and Disposal

Do not store the battery in temperatures above 75° or below -10° F.



CONTAINS SEALED LEAD BATTERY. BATTERY MUST BE RECYCLED.

Disposal: Your Razor product uses sealed lead-acid batteries which must be recycled or disposed of in an environmentally sound manner. Do not dispose of a lead-acid battery in a fire. The battery may explode or leak. Do not dispose of a lead-acid battery in your regular household trash. The incineration, land filling or mixing of sealed lead-acid batteries with household trash is prohibited by law in most areas. Return exhausted batteries to a federal or state approved lead-acid battery recycler or a local seller of automotive batteries. If you live in Florida or Minnesota, it is prohibited by law to throw away lead-acid batteries in the municipal waste stream.

Charger

The transformer/charger supplied with the chopper should be regularly examined for damage to the cord, plug, enclosure and other parts, and, in the event of such damage, the bike must not be charged until it has been repaired or replaced.

Use ONLY with the recommended charger.

Replacement Parts

The most frequently requested replacement parts (wheels, tires, tubes, batteries and chargers) are available for purchase at some Razor retail partners or online at www.razorama.com. For other parts contact an authorized Razor repair center.

Repair Centers

For a list of authorized Razor repair centers:

- Check online at www.razor.com.
- Send e-mail to customerservice@razorusa.com or call 866-467-2967 for the center nearest you.

⚠ WARNING: If a battery leak develops, avoid contact with the leaking acid and place the damaged battery in a plastic bag. Refer to the disposal instructions at left. If acid comes into contact with skin or eyes, flush with cool water for at least 15 minutes and contact a physician.

SB 1918 (CALIFORNIA) DECLARATION

YOUR INSURANCE POLICIES MAY NOT PROVIDE COVERAGE FOR ACCIDENTS INVOLVING THE USE OF THIS SCOOTER/ELECTRIC VEHICLE. TO DETERMINE IF COVERAGE IS PROVIDED, YOU SHOULD CONTACT YOUR INSURANCE COMPANY OR AGENT.

TROUBLESHOOTING GUIDE

Problem	Possible Cause	Solution
Vehicle does not run	Undercharged battery	<p>Charge the battery. A new battery should have been charged for at least 12 hours before using the vehicle for the first time and up to 8 hours after each subsequent use.</p> <p>Check all connectors. Make sure the charger connector is tightly plugged into the charging port, and that the charger is plugged into the wall.</p> <p>Make sure power flow to the wall outlet is on.</p>
	Charger is not working	You may check to see if your charger is working by using a volt meter or asking your local Razor authorized service center to test your charger for you.
	Loose wires or connectors	Check all wires and connectors to make sure they are tight.
Vehicle was running but suddenly stopped	Burned out fuse	<p>The fuse will burn out and automatically shut off the power if the motor is overloaded.</p> <p>An excessive overload, such as too heavy a rider or too steep a hill, could cause the motor to overheat. Replace the fuse with a new one of equal amperage. Correct the conditions that caused the fuse to burn out and avoid repeatedly burning out fuse.</p>
	Motor or electrical switch damage	Contact your local Razor authorized service center for diagnosis and repair.
Short run time (less than 30 minutes per charge)	Undercharged battery	<p>Charge the battery. A new battery should have been charged for at least 12 hours before using the vehicle for the first time and up to 8 hours after each subsequent use.</p> <p>Check all wires and connectors. Make sure the battery connector is tightly plugged into the charger connector, and that the charger is plugged into the wall.</p> <p>Make sure power flow to the wall outlet is on.</p>
	Battery is old and will not accept full charge	Even with proper care, a rechargeable battery does not last forever. Average battery life is 1 to 2 years depending on vehicle use and conditions. Replace only with a Razor replacement battery.
	Brakes are not adjusted properly	Refer to adjusting the brakes instructions on page 4 to properly adjust brakes.
Vehicle runs sluggishly	Driving conditions are too stressful	Use only on solid, flat, clean and dry surfaces such as pavement or level ground.
	Tires are not properly inflated	The tires are inflated when shipped, but they invariably will lose some pressure between the point of manufacturing and your purchase. Refer to instructions on page 5 of this manual to properly inflate tires.
	Vehicle is overloaded	Make sure you do not overload the vehicle by allowing more than one rider at one time, exceeding the 220 lb. maximum weight limit, going up a hill or towing objects behind the vehicle. If the vehicle is overloaded, the circuit breaker may trip and shut off power to the motor. Correct the driving conditions that caused the overload, wait a few seconds, and then push the breaker to reset the circuit. Avoid repeatedly tripping the circuit breaker.
	Brake rotor is dragging on pads (Rebellion Electric Chopper only)	Use your fingers to twist the calliper adjuster in either direction until rotor is centered between pads.
	Brakes are not adjusted properly	Refer to adjusting the brakes instructions on page 4 to properly adjust brakes.

TROUBLESHOOTING GUIDE

Problem	Possible Cause	Solution
Sometimes the vehicle doesn't run, but other times it does	Loose wires or connectors	Check all wires around the motors and all connectors to make sure they are tight.
	Motor or electrical switch damage	Contact your local Razor authorized service center for diagnosis and repair.
Charger gets warm during use	Normal response to charger use	No action required. This is normal for some chargers and is no cause for concern. If your charger does not get warm during use, it does not mean that it is not working properly.
Vehicle does not stop when applying the brake	Brakes are not adjusted properly	Refer to adjusting the brakes instructions on page 4 to properly adjust brakes.
Vehicle makes loud noises or grinding sounds	Chain adjustment is too tight or too loose	Refer to instructions on page 5 and 6 of this manual to properly adjust chain and sprocket.
	Chain is too dry	Apply a lubricant such as WD-40® to the chain.
	Brake rotor is dragging on brake pads (Rebellion Electric Chopper only)	Use your fingers to twist the calliper adjuster in either direction until rotor is centered between pads.

Need Help? Visit our web site for updates and a list of authorized service centers at www.razor.com or call toll-free at **866-467-2967** Monday - Friday 8:00 AM - 5:00 PM Pacific Time.

MINI ELECTRIC CHOPPER PARTS

Keep your Mini Electric Chopper running for years with genuine Razor parts. Visit our web site or e-mail us for more information on spare part availability. (Specifications subject to change without notice.)

1. Handlebar, drag-style
2. Valve stem extender/inflator
3. Handlebar end cap, extender holder
4. Grip, half length
5. Speed control, twist grip
6. Washer, flat 10mm
7. Sleeve, bearing adapter and spacer
8. Spacer, steering
9. Bolt, steering 10mm
10. Nut, nylock-type self-locking 10mm
11. Brake lever w/cut-off switch and electric wire
12. Grip
13. Bearing, 6202 steering
14. Fork crown, upper
15. Fork crown, lower
16. Fork legs
17. Screws, 5mm fender
18. Fender, front
19. Front wheel sub-assembly (hub, spokes, tube, rim strip, tire)
20. Nut, 10mm front axle
21. Washer, front axle safety
22. Electronic control module
23. Screws, 5mm control module
24. Battery set (24v 7AH set) pre-wired with connecting wires
25. Plug, charger input pre-wired w/connector
26. Circuit breaker, pre-wired with connectors
27. Switch, main on/off power
28. Cover, left side battery and motor
29. Grommet, wire harness
30. Cover, right side battery and motor
31. Screw, 3mm button head Phillips self-taping for plastic cover
32. Strap, battery hold-down
33. Screw, cover-to-frame, 5mm socket head cap screw
34. Footrest, left
35. Spring, detent
36. Bearing, detent
37. Dowel nut, 6mm
38. Screw, 6mm button head socket cap screw
39. Tank, tear-drop
40. Screw, 5mm button head socket cap screw
41. U-bar
42. Screw, pan head
43. Seat
44. Screw, seat to frame, 6mm socket head cap screw
45. Motor
46. Screw, motor frame, 6mm socket head cap screw
47. Kickstand
48. Nut, 10mm rear axle
49. Washer, rear axle
50. Bearing, 6200
51. Spacer, outside brake
52. Axle, rear
53. Spacer, inside brake
54. Spacer, outside chain
55. Brake sub-assembly (brake housing, band and lever)
56. Screw, 5mm brake anchor
57. Wheel, rear sub-assembly (wheel, tube, tire, brake drum-A)
58. Fender, rear
59. Screw, 5mm fender mounting
60. Chain
61. Freewheel
62. Sprocket, rear
63. Screw and nut, 6mm mounting for sprocket-to-freewheel
64. Screw, 3mm chainguard mounting
65. Chainguard
66. Rubber insert, chainguard
67. Cover, thread protector
68. Nut, 6mm nylock-type self-locking
69. Stop plate, axle adjuster
70. Bolt, kickstand fixing
71. Spring and button for handlebar
72. Washer, 6mm
73. Frame
74. Axle adjuster

MINI ELECTRIC CHOPPER PARTS

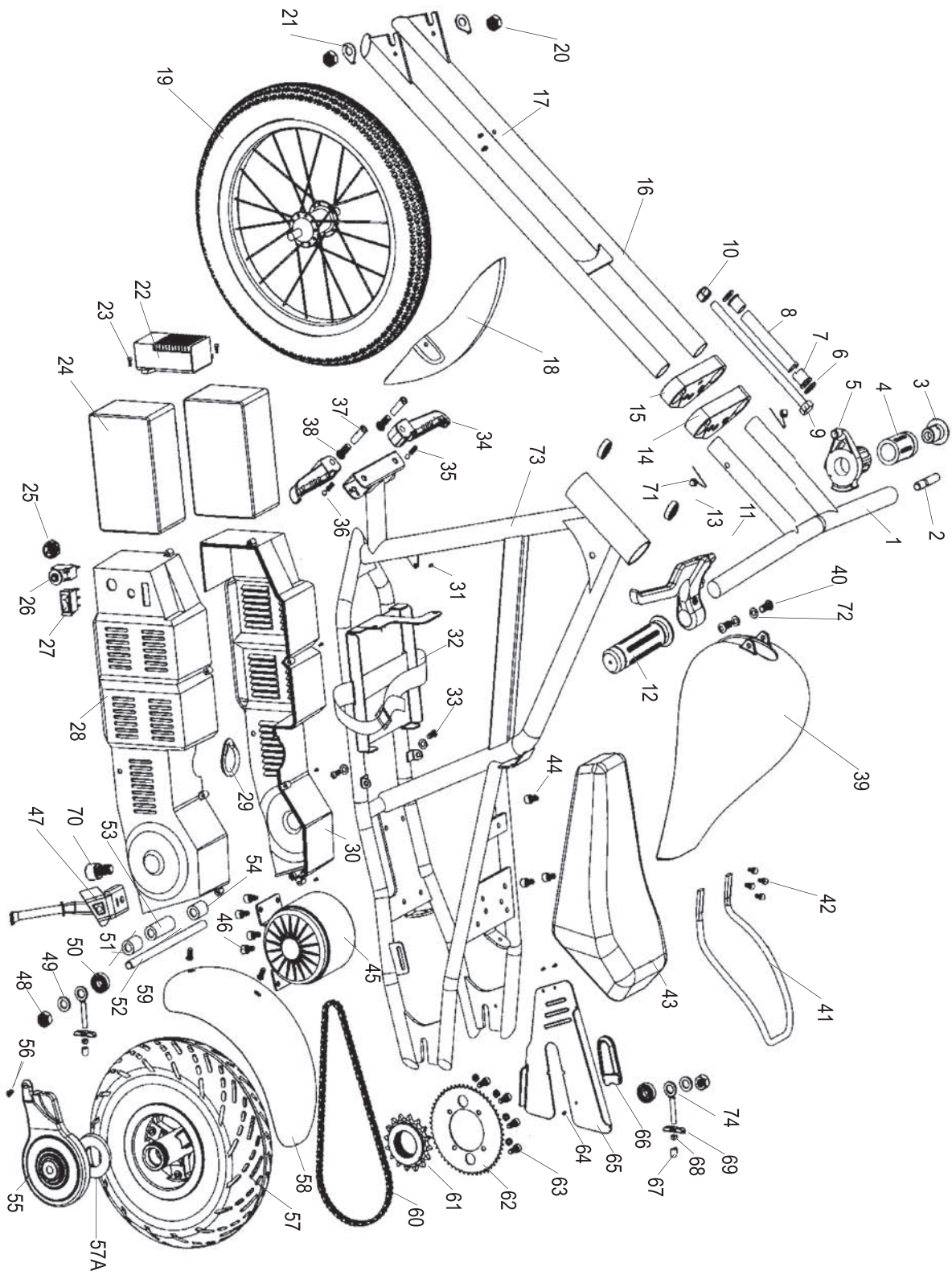

REBELLION ELECTRIC CHOPPER PARTS

Keep your Rebellion Electric Chopper running for years with genuine Razor parts. Visit our web site or e-mail us for more information on spare part availability. (Specifications subject to change without notice.)

1. Front wheel, tire, tube, axle, nut
2. Front fender w/screws
3. Fork legs (2) with both clamps and screws
4. Steering bolt assembly
5. Spring buttons
6. Tire inflator
7. Speed control
8. Tank w/screws
9. Handlebar
10. Brake lever
11. Grips
12. Frame
13. Seat
14. Backrest w/pad and screws
15. Motor, 350W w/screws
16. Chainguard w/screws
17. Chain
18. Chain tensioner w/screws
19. Sprocket, 66t and freewheel w/screws
20. Rear wheel, tire, tube, axle and nuts
21. Rear tire, tube
22. Rear tube only
23. Rear brake w/screws
24. Rear brake pads only
25. Rotor, adapter w/screws
26. Rear fender
27. Pivot bolt, spacers, nut
28. Kickstand w/screws
29. Motor cover w/screws
30. Footrest w/screws
31. 12V 10Ah battery

REBELLION ELECTRIC CHOPPER PARTS

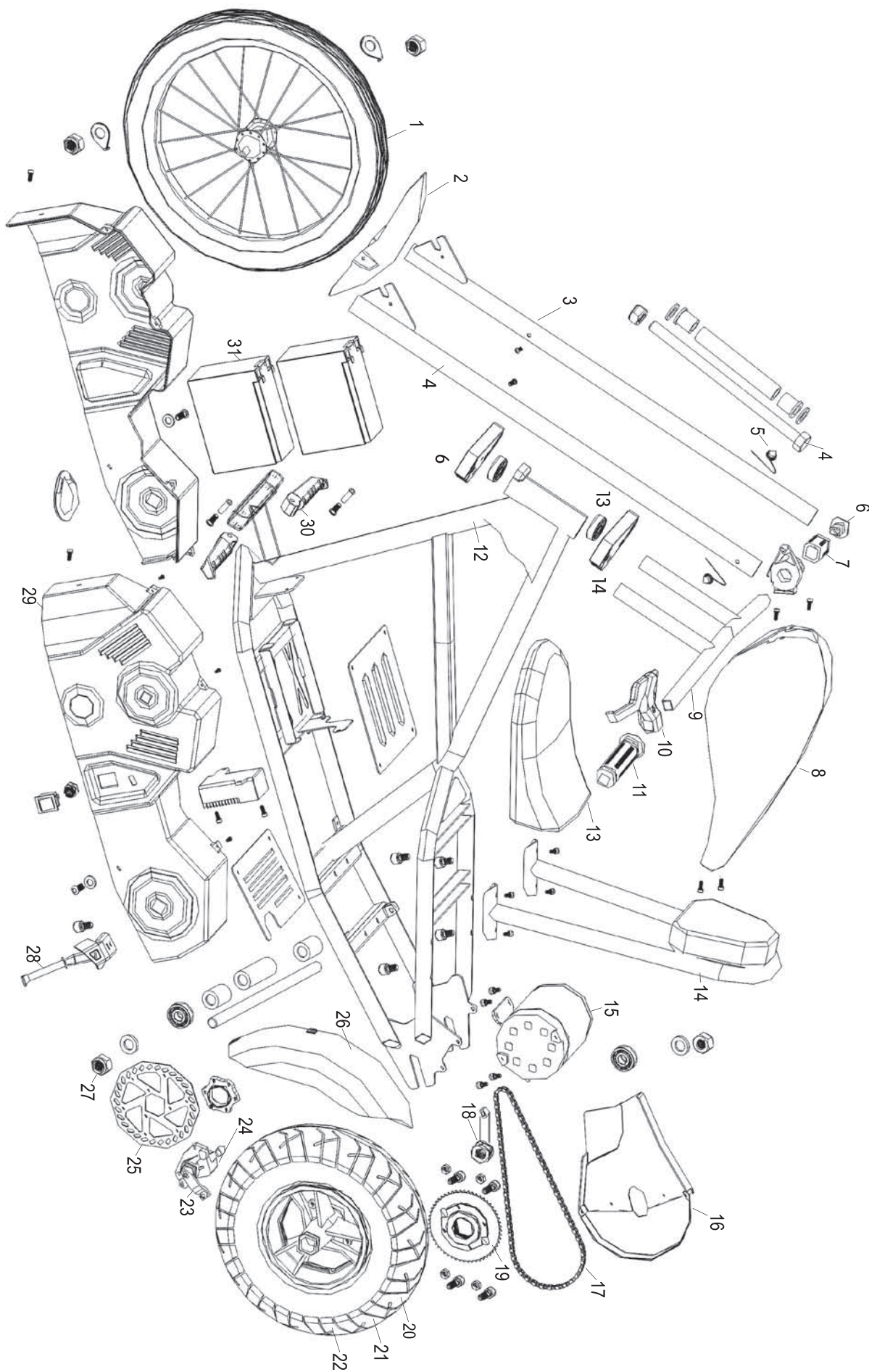

SAFETY REMINDERS

PRE-RIDE CHECKLIST

Loose Parts
There should not be any unusual rattles or sounds from loose parts or broken components. If you are not sure, ask an experienced mechanic to check.

Brake
Check the brake for proper function. When you squeeze the lever, the brake should provide positive braking action. When you apply the brake with the speed control on, the brake cut-off switch will stop the motor.

Frame, Fork and Handlebars
Check for cracks or broken connections. Although broken frames are rare, it is possible for an aggressive driver to bash into a curb or wall and wreck and bend or break a frame. Get in the habit of inspecting yours regularly.

Tire Inflation
Periodically inspect the tires for excess wear and replace as required, and regularly check the tire pressure and re-inflate as necessary. If you get a flat tire, the inner tube can be patched or a new tube can be purchased from Razor or an authorized repair center.

Safety Gear
Always wear proper protective equipment such as an approved safety helmet, elbow pads and kneepads. Always wear shoes, never drive barefooted or in sandals, and keep shoelaces tied and out of the way of the wheels, motor and drive system.

WARRANTY

Razor Limited Warranty

The manufacturer warrants this product to be free of manufacturing defects for a period of 90 days from date of purchase. This Limited Warranty does not cover normal wear and tear, tires, tubes or cables, or any damage, failure or loss caused by improper assembly, maintenance, or storage or use of the Razor electric chopper.

This Limited Warranty will be void if the product is ever

- used in a manner other than for recreation;
- modified in any way;
- rented.

The manufacturer is not liable for incidental or consequential loss or damage due directly or indirectly to the use of this product.

Razor does not offer an extended warranty. If you have purchased an extended warranty, it must be honored by the store at which it was purchased.

For your records, save your original sales receipt with this manual and write the serial number below.

Item Numbers

Mini Electric Chopper
Black 15555-BK
Red 15555-RD
Blue 15555-BL

Rebellion Electric Chopper
15130760

Need Help? Visit our web site for updates and a list of authorized service centers at www.razor.com or call toll-free at **866-467-2967** Monday - Friday 8:00 AM - 5:00 PM Pacific Time.

US DESIGN PATENT NO: US D504 846 S
EC COMMUNITY DESIGN NO: 000236781-0001&0002