

This Owner's Manual is provided and hosted by [Appliance Factory Parts](#).



Razor Eco Smart Metro Owner's Manual

[Shop genuine replacement parts for Razor Eco Smart Metro](#)



[Find Your Razor Ride On Parts - Select From 160 Models](#)

----- Manual continues below -----



ECOSMART™ *metro*™



OWNER'S MANUAL

**Read and understand this entire manual BEFORE riding!
For assistance contact Razor. DO NOT RETURN TO STORE.**

NOTE: Manual illustrations are for demonstration purposes only. Illustrations may not reflect exact appearance of actual product. Specifications subject to change without notice.

Please have your product and 19 digit product I.D. code ready before contacting Razor for warranty assistance and/or replacement parts.

Product I.D. Code: _____ - _____ - _____

CONTENTS

Safety Warnings	1	Troubleshooting Guide.....	8-9
Before You Begin.....	2	EcoSmart Metro Scooter Parts.....	11
Assembly and Set-Up	3-4	Safety Reminders	12
Repair and Maintenance.....	5-6	Warranty	12

SAFETY WARNINGS

⚠ WARNING: Riding electric product can be a hazardous activity. Certain conditions may cause the equipment to fail without fault of the manufacturer. Like other electric products, the EcoSmart Metro electric scooter can and is intended to move, and it is therefore possible to lose control, fall off and/or get into dangerous situations that no amount of care, instruction or expertise can eliminate. If such things occur you can be seriously injured or die, even when using safety equipment and other precautions. **RIDE AT YOUR OWN RISK AND USE COMMON SENSE.**

This manual contains many warnings and cautions concerning the consequences of failing to maintain, inspect or properly use your EcoSmart Metro electric scooter. Because any incident can result in serious injury or even death, we do not repeat the warning of possible serious injury or death each time such a possibility is mentioned.

APPROPRIATE RIDER USE AND PARENTAL SUPERVISION

This manual contains important safety information. It is your responsibility to review this information and make sure that all riders understand all warnings, cautions, instructions and safety topics and assure that young riders are able to safely and responsibly use this product. Razor recommends that you periodically review and reinforce the information in this manual with younger riders, and that you inspect and maintain your teen's scooter to insure their safety.

The recommended rider age of 16 and older for the EcoSmart Metro electric scooter is only an estimate, and can be affected by the rider's size, weight and/or skills. Any rider unable to fit comfortably on the scooter should not attempt to ride it. **A parent's decision to allow his or her teen to ride this product should be based on the teen's maturity, skill and ability to follow rules.**

Keep this product away from small children and remember that this product is intended for use only by persons who are, at a minimum, completely comfortable and competent while operating the product.

DO NOT EXCEED THE WEIGHT LIMIT OF 220 pounds (100kg). Rider weight does not necessarily mean a person's size is appropriate to fit or maintain control of the EcoSmart Metro electric scooter.

Do not touch the brakes or motor on your EcoSmart Metro electric scooter when in use as these parts can become very hot.

Refer to the section on safety reminders for additional warnings.

ACCEPTABLE RIDING PRACTICES AND CONDITIONS

Always check and obey any local laws or regulations which may affect the locations where the EcoSmart Metro electric scooter may be used. Ride defensively. Watch out for potential obstacles that could catch your wheel or force you to swerve suddenly or lose control. Be careful to avoid pedestrians, skaters, skateboards, scooters, bikes, children or animals who may enter your path, and respect the rights and property of others.

Do not attempt or do stunts or tricks on your EcoSmart Metro electric scooter. The scooter is not made to withstand abuse from misuse such as jumping, curb grinding or any other type of stunts.

This product was manufactured for performance and durability, but is not impervious to damage. Jumping or other aggressive riding can over-stress and damage any product, including the EcoSmart Metro electric scooter, and the rider assumes all risks associated with high-stress activity.

Be careful and know your limitations. Risk of injury increases as the degree of riding difficulty increases. The rider assumes all risk associated with aggressive riding activities.

Maintain a hold on the handlebars at all times. Do not activate the throttle unless you are on the product and in a safe, outdoor environment suitable for riding.

Never carry passengers or allow more than one person at a time to ride the EcoSmart Metro electric scooter.

Never use near steps or swimming pools.

Keep your fingers and other body parts away from the drive chain, steering system, wheels and all other moving components.

Never use headphones or a cell phone when riding.

Never hitch a ride with another vehicle.

The EcoSmart Metro electric scooter can operate more quietly than other motorized products may operate. Use care when in the vicinity of pedestrians or others who may have difficulty hearing your approach. Use handbell (not included) to sound warnings when appropriate.

Do not ride the EcoSmart Metro electric scooter in wet or icy weather and never immerse the product in water, as the electrical and drive components could be damaged by water or create other possibly unsafe conditions.

The EcoSmart Metro electric scooter is intended for use on flat, dry surfaces such as pavement or level ground without loose debris such as sand, leaves, rocks or gravel. Wet, slick, bumpy, uneven or rough surfaces may impair traction and braking and contribute to possible accidents. Do not ride the EcoSmart Metro electric scooter in mud, ice, puddles or water. Avoid excessive speeds that can be associated with downhill rides. Never risk damaging surfaces such as carpet or flooring by use of an EcoSmart Metro electric scooter indoors.

Do not ride at night or when visibility is impaired.

PROPER RIDING ATTIRE

Always wear proper protective equipment such as an approved safety helmet (with chin strap securely buckled), elbow pads and kneepads. A helmet may be legally required by local law or regulation in your area. A long-sleeved shirt, long pants and gloves are recommended. Always wear athletic shoes (lace-up shoes with rubber soles), never ride barefooted or in sandals, and keep shoelaces tied and out of the way of the wheels, motor and drive system.

USING THE CHARGER

The charger supplied with the electric product should be regularly examined for damage to the cord, plug, enclosure and other parts. In the event of such damage, the product must not be charged until the charger has been repaired or replaced.

Use only with the recommended charger.

Use caution when charging.

The charger is not a toy. Charger should be operated by an adult.

Do not operate charger near flammable materials.

Make sure power switch is in the "off" position, unplug charger and disconnect from product when not in use.

Do not exceed charging time.

Always disconnect from the charger prior to wiping down and cleaning your scooter.

FAILURE TO USE COMMON SENSE AND HEED THE ABOVE WARNINGS INCREASES RISK OF SERIOUS INJURY. USE WITH APPROPRIATE CAUTION AND SERIOUS ATTENTION TO SAFE OPERATION.

BEFORE YOU BEGIN

Remove contents from box. Remove the foam separators that protect the components from damage during shipping. Inspect the contents of the box for scratches in the paint, dents or kinked cables that may have occurred during shipping. Because the EcoSmart Metro electric scooter was 95 percent assembled and packed at the factory, there should not be any problems, even if the box has a few scars or dents.

Estimated Assembly and Set-Up Time

Razor recommends assembly by an adult with experience in bicycle mechanics. Allow up to 30 minutes for assembly, not including initial charge time. Allow up to 12 hours for initial charge (see page 5 for charging information).

WARNING: DO NOT USE NON-RAZOR PRODUCTS WITH YOUR ECOSMART METRO ELECTRIC SCOOTER. The scooter has been built to certain Razor design specifications. The original equipment supplied at the time of sale was selected on the basis of its compatibility with the frame, fork and all other parts. Certain aftermarket products may or may not be compatible.

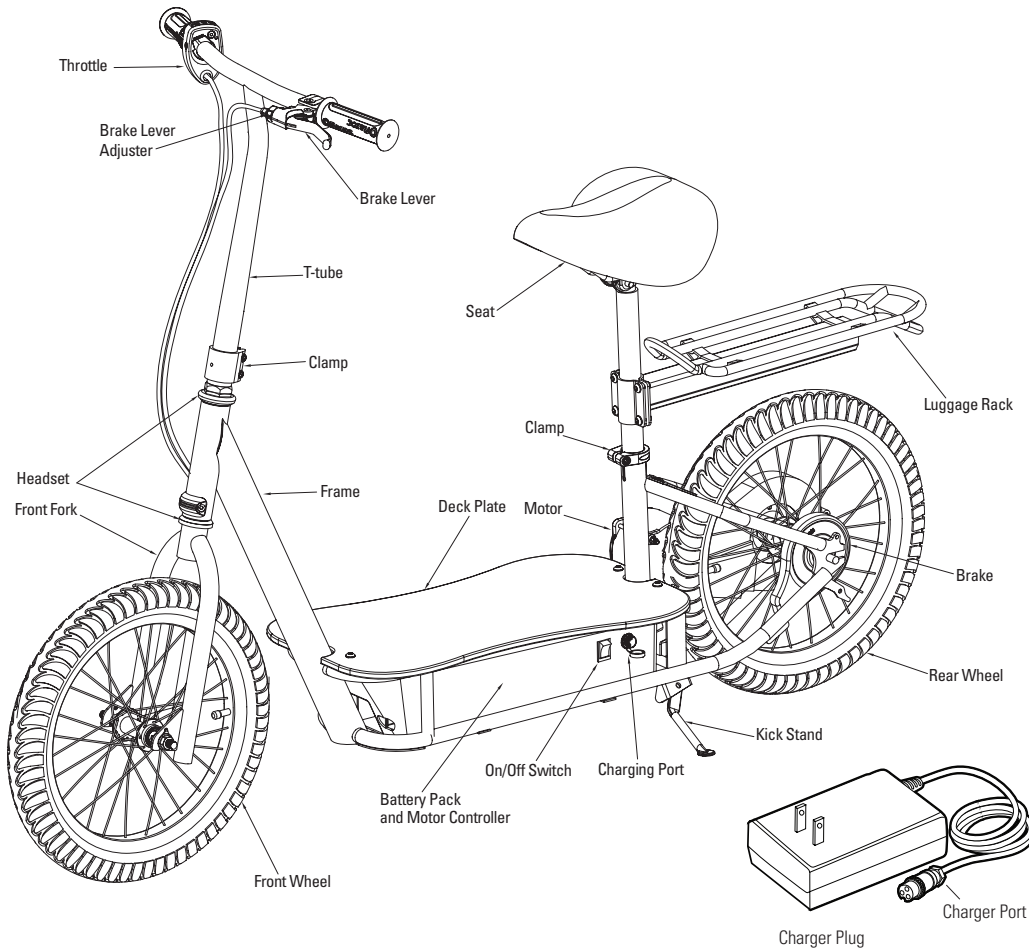

Required Tools

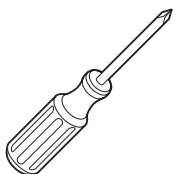

Phillips screwdriver
(included)

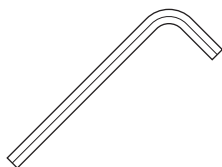

5 mm
Allen wrench
(included)



13/15mm open wrench and
8/10mm open wrench
(included)

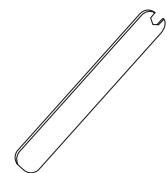

Spoke tightener
(included)

Need Help? Visit our website for replacement parts, product support and a list of authorized service centers at www.razor.com or call toll free 866-467-2967 Monday - Friday 8AM - 5PM Pacific Time. Please have the product I.D. code located on the white label on your product or back of charger available for better assistance.

ASSEMBLY AND SET-UP

□ Attaching the Front Wheel

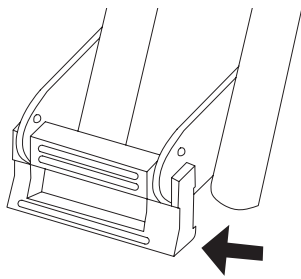

1 Remove the packing material from the front fork.

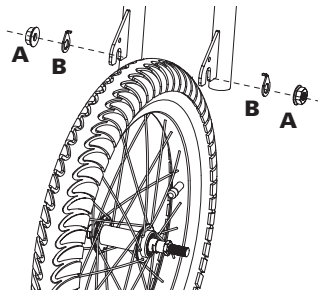

2 Remove axle nuts (A) from the axle bolt and insert the wheel into the front fork. Safety washers (B) should face outside of the fork.

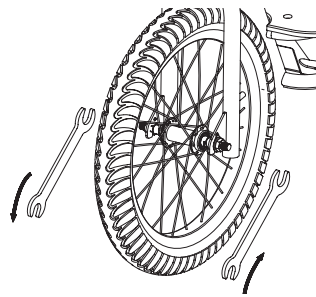

3 Insert the tab on the safety washer (B) into the hole on the front fork and tighten axle nuts using two 15mm open wrenches.

□ Attaching the Handlebar

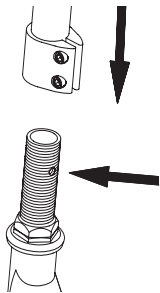

1 Face the handlebars forward with the throttle on the right and brake on the left, depress the push button located on the front fork and insert the handlebar stem until the button locks securely into the stem.

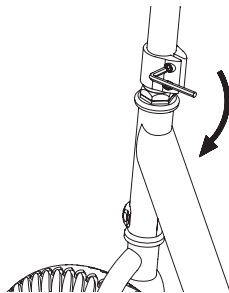

2 Tighten the collar clamp using a 5mm Allen wrench.

□ Attaching the Seat and Luggage Rack

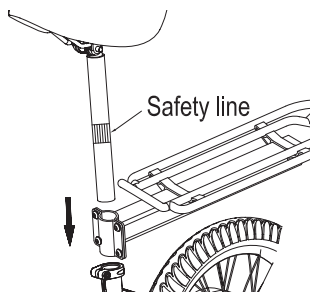

1 Slide the seat tube through the luggage rack and into the frame tube down to the safety line on the seat tube.

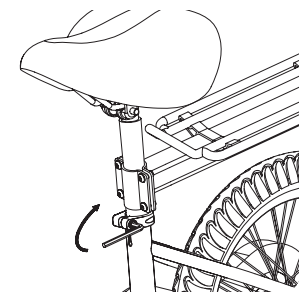

2 The clamp of the luggage rack should be above the seat clamp. Adjust seat to the desired height. Secure the seat by tightening the collar clamp bolt using a 5mm Allen wrench.

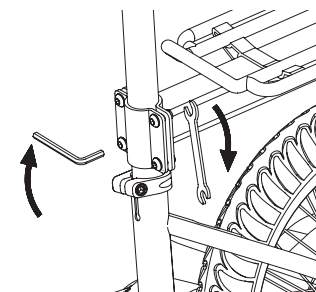

3 Adjust the luggage rack to the desired height and tighten the 4 bolts on the luggage rack with 5mm Allen wrench and 10mm open wrench.

⚠ WARNING: Failure to properly tighten the collar bolts may allow the handlebars to dislodge while riding and may cause you to lose control and fall. When correctly tightened, the handlebars will not rotate out of alignment with the front wheel under normal circumstances.

Note: The cable and wire assembly from the handlebar must not be wrapped around the steering tube or handlebar. Sharp bends or twisting of the brake cable can cause the brakes to malfunction.

⚠ WARNING: Failure to properly install and tighten the screws, nuts and bolts that affix seat can cause you to lose control and crash.

ASSEMBLY AND SET-UP

□ Attaching the Basket

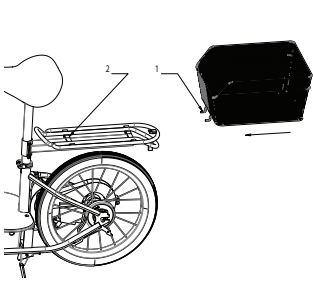

1 Slide the basket hooks (1) under the bar located on the luggage rack.

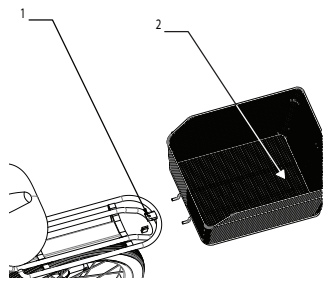

2 Align the hole in the basket (2) with the hole on the luggage rack (1).

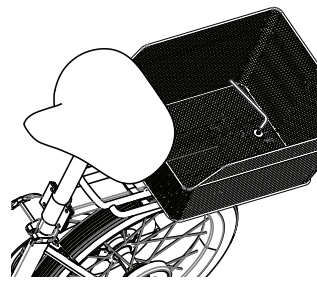

3 Insert the washer and bolt into the hole in the basket and through the bracket on the luggage rack. Using a 5mm Allen wrench, tighten the bolt until the basket is securely attached to the rack.

⚠ WARNING:

Do not exceed weight limit of 11lbs (5kg) on luggage rack.

⚠ WARNING:

The carrier should not be used to carry people or pets.

Turn power switch "OFF" before conducting any maintenance procedures.

□ Adjusting the Brakes

Tools required: 10mm open wrench

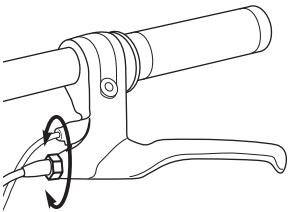

1 To adjust the brake cable play, thread the brake lever adjuster in or out 1/4 to 1/2 turn until the desired brake adjustment is attained. Most adjustments are complete at this step. If brake still needs further adjustment, proceed to step 2.

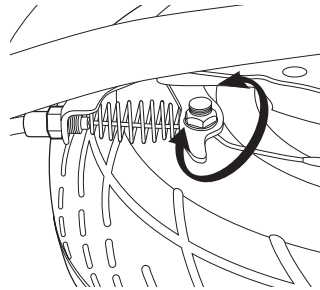

2 If the brake is too tight or too loose, use a 10mm open wrench to loosen the nut for additional adjustment on the brake cable. Securely tighten the nut when finished.

⚠ WARNING:

The brake is capable of skidding the rear tire and throwing an unsuspecting rider. Practice in an open area free from obstacles until you are familiar with the brake function. Avoid skidding to a stop as this can cause you to lose control and/or damage the rear tire.

Need Help? Visit our website for replacement parts, product support and a list of authorized service centers at www.razor.com or call toll free 866-467-2967 Monday - Friday 8AM - 5PM Pacific Time. Please have the product I.D. code located on the white label on your product or back of charger available for better assistance.

REPAIR AND MAINTENANCE

❑ Charging the Battery

Your electric scooter may not have a fully charged battery. Therefore it is a good idea to charge the battery prior to use.

- Initial charge time: 12 hours
- Recharge time: up to 12 hours, even if the light turns green. Recommended maximum charging time is 24 hours.
- Always charge the battery immediately after riding.
- Fully charge battery before storing for extended periods of time.
- Unplug charger from the wall outlet when not in use.
- Failure to recharge battery periodically may result in a battery that will not accept a charge.
- Make sure scooter power switch is turned **OFF** when unit is not in use. If the power switch is left on for an

extended period of time, the battery may reach a stage at which it will no longer hold a charge.

- To ensure long battery life, never store the product in freezing or below freezing temperatures! Freezing will permanently damage the battery.
- Run time: Up to 40 minutes of continuous ride time. Run time may vary depending on riding conditions, climate and/or proper maintenance.
- Constant stopping and starting may shorten ride time.
- Average battery life for a properly maintained unit is approx. 250 charge/discharge cycles.

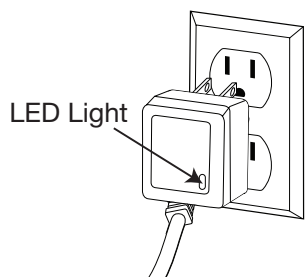
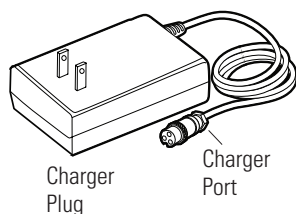

- 1** Plug the charger plug into a wall outlet.
Note: If charger lights do not turn on when plugged into the wall, try another outlet.

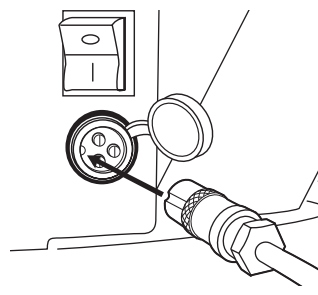

- 2** Turn power to the "OFF" position. Plug the charger into the charger port as shown.

! WARNING: Always disconnect your EcoSmart Metro electric scooter from the charger before cleaning.

Note: If your charger does not look like the one illustrated, your unit has been supplied with an alternative charger. The specifications and charging procedure would not change.

The charger has a small window with one LED to indicate the charge status. Refer to the illustration on the charger unit for the actual "charging" and "charged" status indications for your model charger.

Chargers have built-in over-charge protection to prevent battery from being over-charged.

Be sure to properly align the groove on the charger input plug with the corresponding socket on the case; otherwise, no charging action will occur.

❑ Inflating the Tires

Tires are inflated when shipped, but they invariably lose some pressure between the point of manufacturing and your purchase. Low tire pressure can decrease the ride time of your unit.

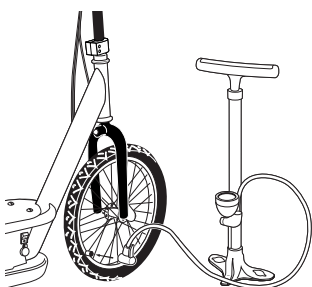

- 1** Using a bicycle style pump equipped for a Schrader-type valve, inflate the tires to the PSI indicated on the sidewall of the tires.

Note: Low air pressure can decrease the ride time of your unit.

Note: The pressurized air supplies found at gasoline stations are designed to inflate high-volume automobile tires. If you decide to use such an air supply to inflate tires, first make sure the pressure gauge is working, then use very short bursts to inflate to the correct PSI. If you inadvertently over-inflate the tire, release the excess pressure immediately.

Need Help? Visit our website for replacement parts, product support and a list of authorized service centers at www.razor.com or call toll free 866-467-2967 Monday - Friday 8AM - 5PM Pacific Time. Please have the product I.D. code located on the white label on your product or back of charger available for better assistance.

REPAIR AND MAINTENANCE

☐ Checking Spoke Tension

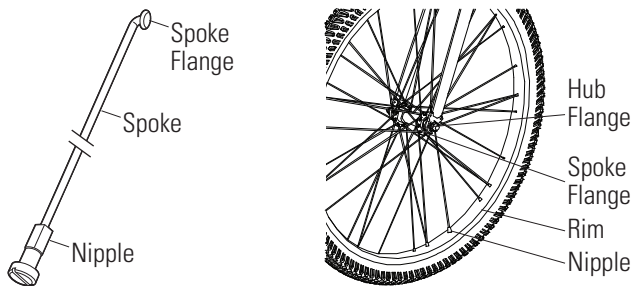

1 Verify spoke tension by grasping and shaking each spoke. Spoke should not be loose from hub. Look for any play between spoke flanges where it mates with hub. Try to turn nipple using your fingers. You should not be able to spin any nipple by hand. If one or more spokes are loose, or if you can turn any nipple using your fingers, all spokes must be checked and need to be tightened.

☐ Battery Care and Disposal

Do not store in freezing or below freezing temperatures.



CONTAINS SEALED LEAD ACID BATTERIES. BATTERIES MUST BE RECYCLED.

Disposal: Your Razor product uses sealed lead-acid batteries which must be recycled or disposed of in an environmentally safe manner. Do not dispose of a lead-acid battery in a fire. The battery may explode or leak. Do not dispose of a lead-acid battery in your regular household trash. The incineration, land filling or mixing of sealed lead-acid batteries with household trash is prohibited by law in most areas. Return exhausted batteries to a federal or state approved lead-acid battery recycler or a local seller of automotive batteries. If you live in Florida or Minnesota, it is prohibited by law to throw away lead-acid batteries in the municipal waste stream.

☐ Charger

The charger supplied with the EcoSmart Metro electric scooter should be regularly examined for damage to the cord, plug, enclosure and other parts and in the event of such damage, the product must not be charged until it has been repaired or replaced.

Use **ONLY** with the recommended charger.

☐ Wheels

Wheels and drive system are subject to normal wear and tear. It is the responsibility of the user to periodically inspect wheels for excess wear and adjust and replace drive train components as required.

☐ Replacement Parts

The most frequently requested replacement parts are available for purchase at some Razor retail partners. For the complete selection of replacement parts visit www.razor.com/shop.

☐ Authorized Service Centers

For a list of authorized Razor repair centers:

- Check online at www.razor.com.
- Call 866-467-2967 for a list of Authorized Service Centers near you.

! WARNING:

Regularly check the spoke tension and retighten the spokes whenever loose. If you have any doubt, ask an experienced motorcycle or bicycle mechanic to inspect your spokes to determine if the spokes need tightening or adjusting.



WARNING: If a battery leak develops, avoid contact with the leaking acid and place the damaged battery in a plastic bag. Refer to the disposal instructions at left. If acid comes into contact with skin or eyes, flush with cool water for at least 15 minutes and contact a physician.



WARNING: Battery posts, terminals and related accessories contain lead and lead compounds. **Wash your hands after handling.**

SB 1918 (CALIFORNIA) DECLARATION

YOUR INSURANCE POLICIES MAY NOT PROVIDE COVERAGE FOR ACCIDENTS INVOLVING THE USE OF THIS SCOOTER/ELECTRIC RIDE-ON PRODUCT. TO DETERMINE IF COVERAGE IS PROVIDED, YOU SHOULD CONTACT YOUR INSURANCE COMPANY OR AGENT.

TROUBLESHOOTING GUIDE

Problem	Possible Cause	Solution
Scooter does not run	Undercharged battery	<p>Charge the battery. A new battery should have been charged for at least 12 hours before using the scooter for the first time and up to 12 hours after each subsequent use.</p> <p>Check all connectors. Make sure the charger connector is tightly plugged into the charging port and that the charger is plugged into the wall.</p> <p>Make sure power flow to the wall outlet is on.</p>
	Charger is not working	You may check to see if your charger is working by using a volt meter or ask your local Razor authorized service center to test your charger for you.
	Loose wires or connectors	Check all wires and connectors to make sure they are tight.
Scooter was running but suddenly stopped		<p>Power will automatically shut off if the motor is overloaded.</p> <p>An excessive overload, such as too heavy a rider or too steep a hill, could cause the motor to overheat. If the scooter suddenly stops running, wait a few seconds and then push the breaker to reset the circuit. Correct the conditions that caused the breaker to trip and avoid repeatedly tripping the breaker.</p>
Short run time (less than 40 minutes per charge)	Undercharged battery	<p>Charge the battery. A new battery should have been charged for at least 12 hours before using the scooter for the first time and up to 12 hours after each subsequent use.</p> <p>Check all wires and connectors. Make sure the battery connector is tightly plugged into the charger connector and that the charger is plugged into the wall.</p> <p>Make sure power flow to the wall outlet is on.</p>
	Battery is old and will not accept full charge	Even with proper care, a rechargeable battery does not last forever. Average battery life is 1 to 2 years depending on scooter use and conditions. Replace only with a Razor replacement battery.
	Brakes are not adjusted properly	Refer to adjusting the brakes instructions on page 4.
Scooter runs sluggishly	Driving conditions are too stressful	Use only on solid, flat, clean and dry surfaces such as pavement or level ground.
	Tires are not properly inflated	The tires are inflated when shipped, but they invariably will lose some pressure between the point of manufacturing and your purchase. Refer to instructions on page 5 of this manual to properly inflate tires.
	Scooter is overloaded	Make sure you do not overload the scooter by allowing more than one rider at a time, exceeding the 220 lb. maximum weight limit, going up a hill or towing objects behind the scooter. If the scooter is overloaded, the circuit breaker may trip and shut off power to the motor. Correct the riding conditions that caused the overload, wait a few seconds, and then push the breaker to reset the circuit.
	Brake rotor is dragging on pads	Use your fingers to twist the caliper adjuster in either direction until rotor is centered between pads.
	Brakes are not adjusted properly	Refer to adjusting the brakes instructions on page 4.

Need Help? Visit our website for replacement parts, product support and a list of authorized service centers at www.razor.com or call toll free 866-467-2967 Monday - Friday 8AM - 5PM Pacific Time. Please have the product I.D. code located on the white label on your product or back of charger available for better assistance.

TROUBLESHOOTING GUIDE

Problem	Possible Cause	Solution
Sometimes the scooter doesn't run, but other times it does	Loose wires or connectors	Check all wires around the motor and all connectors to make sure they are tight.
	Motor or electrical switch damage	Contact your local Razor authorized service center for diagnosis and repair.
Charger gets warm during use	Normal response to charger use	No action required. This is normal for some chargers and is no cause for concern. If your charger does not get warm during use, it does not mean that it is not working properly.
Scooter does not stop when applying the brake	Brakes are not adjusted properly	Refer to adjusting the brakes instructions on page 4.
Scooter makes loud noises or grinding sounds	Chain is too dry	Apply a lubricant such as 3 in 1™ or Tri-Flow™ to the chain.
	Brake rotor is dragging on brake pads	Use your fingers to twist the caliper adjuster in either direction until rotor is centered between pads.

Need Help? Visit our website for replacement parts, product support and a list of authorized service centers at www.razor.com or call toll free 866-467-2967 Monday - Friday 8AM - 5PM Pacific Time. Please have the product I.D. code located on the white label on your product or back of charger available for better assistance.

ECOSMART METRO PARTS

Keep your EcoSmart Metro electric scooter running for years with genuine Razor parts. Visit our web site or e-mail us for more information on spare part availability. (Specifications subject to change without notice.)

- | | | | |
|-----------------------|---|-------------------------|----------------------|
| 1. Handle grip | 9. Front fork | 16. On/Off switch | 24. Motor (36v 500w) |
| 2. Throttle | 10. Nut | 17. Charger port | 25. Clamp |
| 3. Handlebar | 11. Socket head cap screws | 18. Kick stand | 26. Seatpost |
| 4. Brake lever (left) | 12. Front wheel complete | 19. Control module | 27. Luggage rack |
| 5. Clamp | 13. Lock block | 20. Rear wheel complete | 28. Deck plate |
| 6. Headset | 14. Battery system w/ (1) 30 amp fuse (3 - 12v/7Ah) | 21. Chain | 29. Seat |
| 7. Protective cover | 15. Battery tray | 22. Chain guard | 30. Basket |
| 8. Spring fastener | | 23. Chain tensioner | |

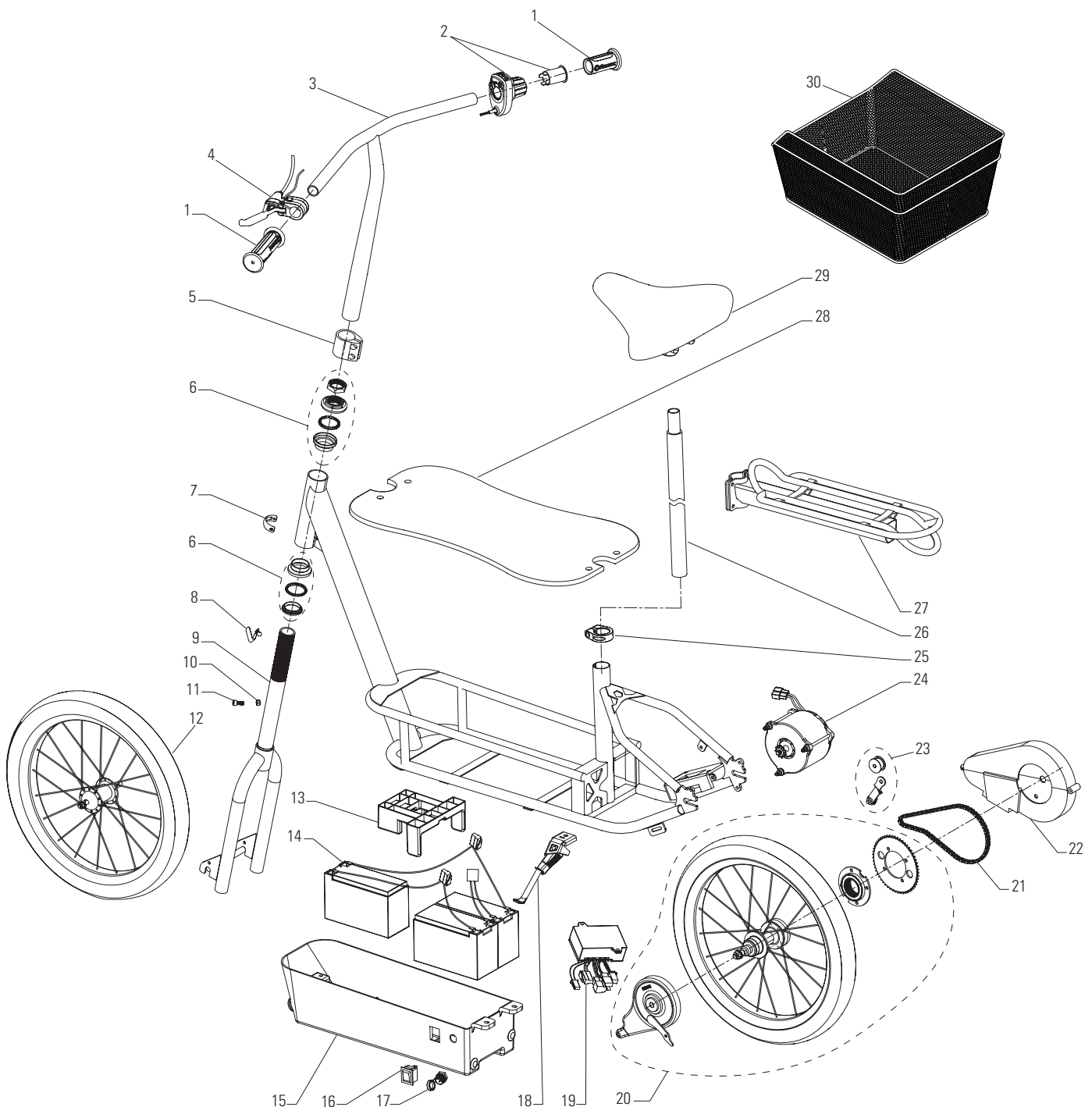

SAFETY REMINDERS

PRE-RIDE CHECKLIST



Loose Parts

Check and secure all fasteners before every ride. Make sure steering stem clamp bolts are locked properly in place. There should not be any unusual rattles or sounds from loose parts or broken components. If you are not sure, ask an experienced mechanic to check.



Brake

Check the brakes for proper function. When you squeeze the levers, the brake should provide positive braking action. When you apply the brake with the speed control on, the brake cut-off switch will stop the motor.



Frame, Fork and Handlebars

Check for cracks or broken connections. Although broken frames are rare, it is possible for an aggressive rider to run into a curb or wall and wreck and bend or break a frame. Get in the habit of inspecting yours regularly.



Tire Inflation

Periodically inspect the tires for excess wear and regularly check the tire pressure and re-inflate as necessary. If you get a flat tire, the inner tube can be patched or a new tube can be purchased from Razor or an authorized repair center.



Safety Gear

Always wear proper protective equipment such as an approved safety helmet, elbow pads and kneepads. Always wear athletic shoes (lace-up shoes with rubber soles), never ride barefooted or in sandals, and keep shoelaces tied and out of the way of the wheels, motor and drive system.



DO NOT RETURN TO STORE

Do not use this product for the first time until you have charged the battery for at least 12 hours.

Failure to follow these instructions may damage your product and void your warranty.

WARRANTY

Razor Limited Warranty

The manufacturer warrants this product to be free of manufacturing defects for a period of 90 days from date of purchase. This Limited Warranty does not cover normal wear and tear, tires, tubes or cables, or any damage, failure or loss caused by improper assembly, maintenance, storage or use of the Razor EcoSmart Metro electric scooter.

This Limited Warranty will be void if the product is ever

- used in a manner other than for recreation or transportation;
- modified in any way;
- rented.

The manufacturer is not liable for incidental or consequential loss or damage due directly or indirectly to the use of this product.

Razor does not offer an extended warranty. If you have purchased an extended warranty, it must be honored by the store at which it was purchased.

For your records, save your original sales receipt with this manual and write the serial number below.

Item Number
13114501

Need Help? Visit our website for replacement parts, product support and a list of authorized service centers at www.razor.com or call toll free 866-467-2967 Monday - Friday 8AM - 5PM Pacific Time. Please have the product I.D. code located on the white label on your product or back of charger available for better assistance.

Patent Pending
Printed in China for:
Razor USA LLC
PO Box 3610
Cerritos, CA 90703

Copyright © 2003-2012 Razor USA LLC. All rights reserved. RAZOR and the Razor Logo Design are among the registered trademarks of Razor USA LLC in the United States and/or select foreign countries.