

A D V A N T A G E

ULTRACOOOL

CHAMPION RESIDENTIAL ULTRACOOOL

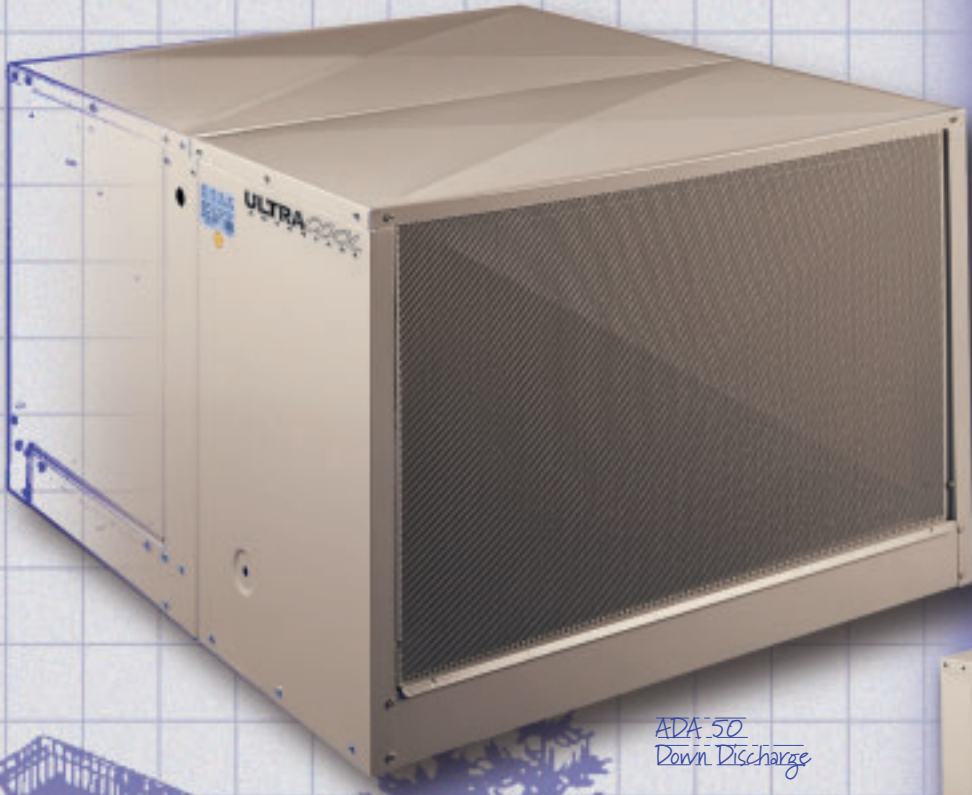

RESIDENTIAL

EVAPORATIVE

AIR COOLERS

ADA 50
Down Discharge



ASA 35
Side Discharge

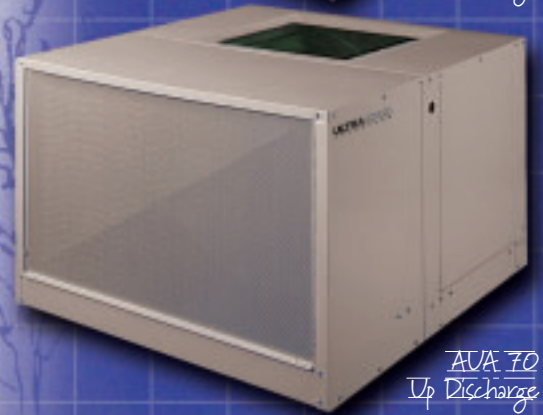

AUA 70
Up Discharge



CHAMPION
COOLER

STANDARD FEATURES

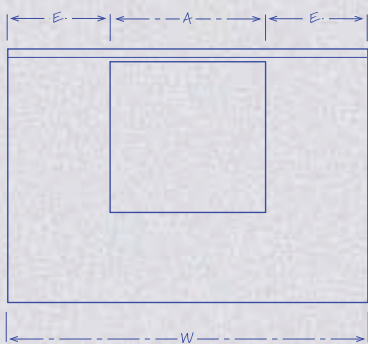
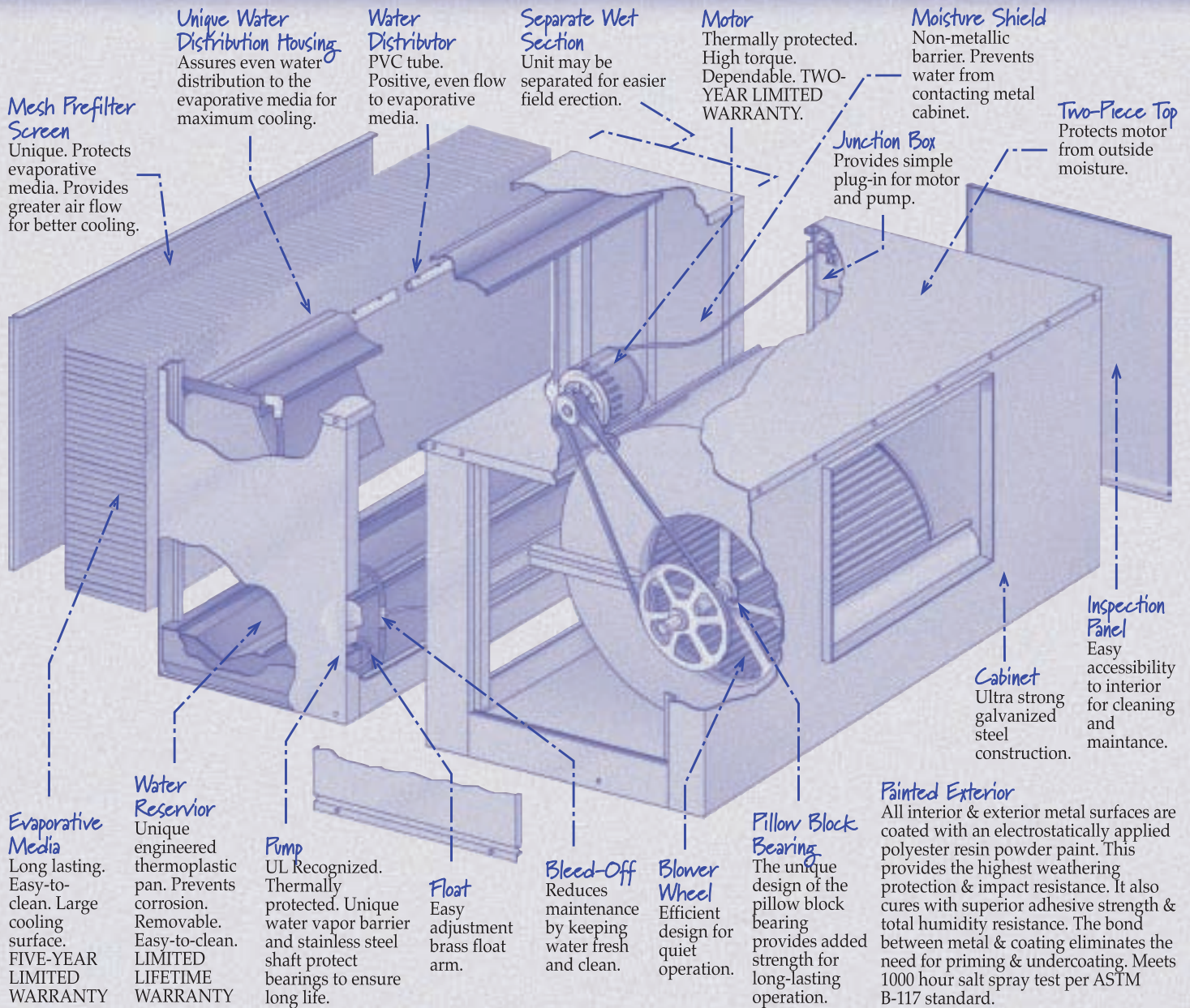

FRONT VIEW

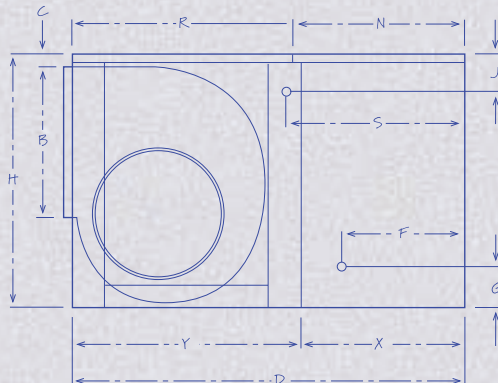

SIDE VIEW

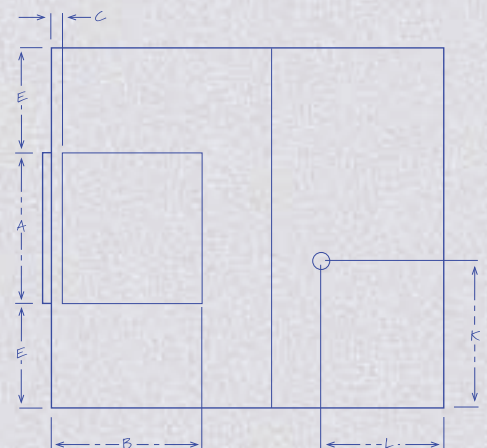

TOP VIEW

DIMENSIONS

Match letters on illustrations to Cabinet Dimensions in the Specification Tables on next page.

SPECIFICATIONS

CABINET DIMENSIONS*

MODEL NO.	GENERAL DIMENSIONS			DUCT				WATER SERVICE LOCATION	ELECTRICAL SERVICE LOCATION	DRAIN LOCATION		BLOWER WHEEL			BELT LENGTH	WEIGHT		MODULE LENGTH		TOP PAN LENGTH			
				OPENING		LOCATION						DIA.	WIDTH	SHAFT		OPER.	SHIP.	X	Y	R	N		
	H	W	D	A	B	C	E	F	G	S	J				K							L	
ADA35 ASA35	22 ^{9/16}	34	40	13 ^{5/8}	13 ^{5/8}	1	10 ^{3/16}	14 ^{7/16}	5 ^{1/4}	20 ^{1/2}	3 ^{5/8}	17	14 ^{5/8}	12 ^{7/8}	12 ^{1/8}	1	43	187	130	17 ^{15/16}	22	-	-
						1 ^{7/8}											46						
ADA50 ASA50 AUA50	28	42	45	17 ^{3/4}	17 ^{3/4}	1 ^{1/2}	12 ^{1/8}	13	5 ^{3/4}	20 ^{3/8}	3 ^{9/16}	17	14 ^{1/16}	16	16 ^{3/4}	1	52†	252	179	18 ^{1/4}	26 ^{3/4}	25 ^{7/8}	19 ^{1/16}
																	57					25 ^{7/8}	19 ^{1/16}
																	51					32 ^{3/16}	12 ^{3/4}
ADA5012 ASA5012	28	42	49	17 ^{3/4}	17 ^{3/4}	1 ^{1/2}	12 ^{1/8}	17	5 ^{3/4}	24 ^{3/8}	3 ^{9/16}	17	18 ^{1/16}	16	16 ^{3/4}	1	52†	272	192	22 ^{1/4}	26 ^{3/4}	25 ^{7/8}	23 ^{1/16}
ADA70 ASA70 AUA70	34 ^{5/8}	42	48	19 ^{3/4}	19 ^{3/4}	1 ^{1/2}	11 ^{1/8}	13	5 ^{3/4}	20 ^{3/8}	3 ^{9/16}	17	14 ^{1/16}	20	16 ^{3/4}	1	64	294	215	18 ^{1/4}	29 ^{3/4}	28 ^{7/8}	19 ^{1/16}
																	67					28 ^{7/8}	19 ^{1/16}
																	67					35 ^{3/16}	12 ^{3/4}
ADA7012 ASA7012	34 ^{5/8}	42	52	19 ^{3/4}	19 ^{3/4}	1 ^{1/2}	11 ^{1/8}	17	5 ^{3/4}	24 ^{3/8}	3 ^{9/16}	17	18 ^{1/16}	20	16 ^{3/4}	1	64	321	235	22 ^{1/4}	29 ^{3/4}	28 ^{7/8}	23 ^{1/16}
																	67						

*All dimensions in inches. † 3/4 H.P. requires a 53" belt.

ELECTRICAL SPECIFICATIONS*

CFM**** INCHES STATIC PRESSURE

MODEL NO.	INDUSTRY STANDARD RATING	H.P.	SPEEDS**	PHASE	VOLTS**	AMPS***	0'	0.1'	0.2'	0.3'	0.4'	0.5'	0.6'
ADA/ASA 35	3000	1/3	1 OR 2	1	115	8.3	2022	1871	1738	1607	1470	1311	1107
	3500	1/2					2315	2178	2061	1947	1834	1714	1581
ADA/ASA/ AUA 50	4000	1/3	1 OR 2	1	115	8.3	2873	2650	2390	2060	1806	1600	1370
	4400	1/2					3321	3110	2910	2650	2400	2130	1940
	5000	3/4					3788	3630	3450	3260	3020	2806	2570
ADA/ASA 5012	4000	1/3	1 OR 2	1	115	8.3	2750	2566	2323	1997	1629	1313	1039
	4400	1/2					3149	2993	2803	2564	2266	1944	1648
	5000	3/4					3606	3472	3317	3135	2918	2661	2379
ADA/ASA/ AUA 70	5400	1/2	1 OR 2	1	115	10.9	3987	3750	3510	3270	3055	2610	2210
	6000	3/4					4564	4350	4130	3940	3730	3580	3180
	7000	1					5024	4820	4630	4450	4280	4100	3900
ADA/ASA 7012	5400	1/2	1 OR 2	1	115	10.9	3922	3685	3462	3212	2898	2471	2002
	6000	3/4					4488	4279	4087	3888	3662	3392	3049
	7000	1					4941	4747	4572	4394	4208	3996	3749

*All dimensions in inches. **Motors shipped separately. ***Blower motor (high speed) and pumps. ****Cubic feet per minute. CFM ratings are based on test data to AMCA (Air Movement and Control Association) standard 210 by an independent AMCA approved laboratory.

OPTIONAL THERMOSTAT ACCESSORY



STANDARD FEATURES

- Large LED readout is easy to read
- Easy 4-wire hook up makes installation quick and simple
- Durable rain-proof control box ensures safety
- Thermostat controlled dump cycle adds convenience
- Dump cycle control is compatible with any pump!
- Two-stage operation provides better comfort and even temperatures
- Easy to program and operate

Contact your local Champion dealer today for more information on why an UltraCool Advantage[®] Evaporative Cooler should be your First Choice. Only Choice.

SELECTING AN ULTRACOOOL COOLER

1. Consult zone map to find correct zone.
2. Consult table below to find correct "Minutes per Air Change" for your zone.
3. Determine area to be cooled in cubic feet (building length x width x height).
4. Divide cubic feet (step 3) by minutes per air change (step 2) to determine Cubic Feet per Minute (CFM).
5. Select the correct Champion Cooler model in the data table on the previous page according to CFM and expected static pressure. If CFM falls between models, choose the larger model.

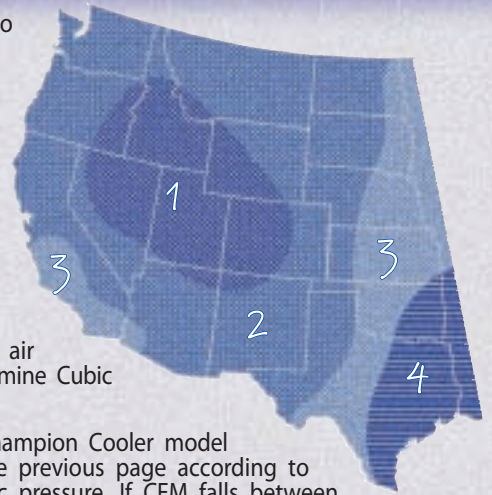

MINUTES PER AIR CHANGE

INTERIOR HEAT LOAD	EXTERIOR HEAT LOAD	ZONE			
		1	2	3	4
HIGH	EXPOSED	2	1.5	1.3	.7
HIGH	INSULATED	3	2	1.5	1
NORMAL	EXPOSED	3	2	1.5	1
NORMAL	INSULATED	4	3	2	1.3

- **INTERIOR HEAT LOAD:** High means places with unusual heat sources from hot equipment or processes, crowded conditions, etc. Normal means no unusual heat sources - typical home or office.
- **EXTERIOR HEAT LOAD:** Exposed means walls, roof exposed to sun, poor insulations, etc. Insulated means walls and roof well insulated and/or shaded.

EXAMPLE - A house in Phoenix, AZ, 40 feet long by 30 feet wide with 8-foot ceiling. Well insulated, no unusual heat sources.

1. $30 \times 40 \times 8 = 9,600$ cubic feet
2. Zone 2
3. Minutes per Air Change = 3
4. $9,600 \div 3 = 3,200$ CFM
5. Referring to CFM table inside this brochure, cooler model ADA50 with a 3/4 h.p. motor is indicated, assuming a typical static pressure of .2" W.G.

Designed with You in Mind!

CHAMPION COOLERS



 Crafted With Pride In The USA

5800 Murray, Little Rock, AR 72209 800-643-8341 www.championcooler.com

Catalog No. CUCB-Sept. 2005