

This Owner's Manual is provided and hosted by [Appliance Factory Parts](#).



Broil King 9565-54 Owner's Manual

[Shop genuine replacement parts for Broil King 9565-54](#)

Broil King®

[Find Your Broil King Grill Parts - Select From 1350 Models](#)

----- Manual continues below part list -----

Available Replacement Parts for Broil King 9565-54

11051	burner, Read Ext info please...
99041	heat plate, ss, 17.5625 x 6.3125
67845	grid, ci, 19.1875 x 30.3125; Master Forg
00475	heat indicator
33200	get jet Orifice Drilled to #57
10342-245	IGNITOR ELECTRONIC DUAL +
08032	BURNER CROSSOVER BAR, SS
04831	ELECTRODE WITH WIRE

Broil King®

REDDI-BILT BARBECUES

ASSEMBLY MANUAL & PARTS LIST

MANUEL DE MONTAGE & LISTE DE PIÈCES



Broil King
REGAL 420
9561-54
9561-57



Broil King
REGAL 420 PRO
9565-14
9565-17
9565-54
9565-57

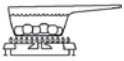

Broil King
REGAL 440
9561-64
9561-67

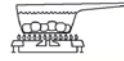

Broil King
REGAL 440 PRO
9565-24
9565-27
9565-64
9565-67

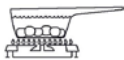

Broil King
REGAL 490
9561-84
9561-87

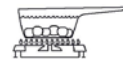

Broil King
REGAL 490 PRO
9565-44
9565-47
9565-84
9565-87

RETAIN FOR FUTURE REFERENCE

VEUILLEZ CONSERVER POUR REFERENCE ULTERIEURE

ASSEMBLY VIDEO

VIDÉO MONTRANT
L'ASSEMBLAGE

VIDEO DE
ENSAMBLAJE



BROILKINGBBQ.COM

Onward
MANUFACTURING COMPANY
SINCE 1906
1000 EAST MARKET STREET
HUNTINGTON, INDIANA, 46750, USA

info@omcbbq.com
1-800-265-2150

20084-E77 REV E 02/14

1

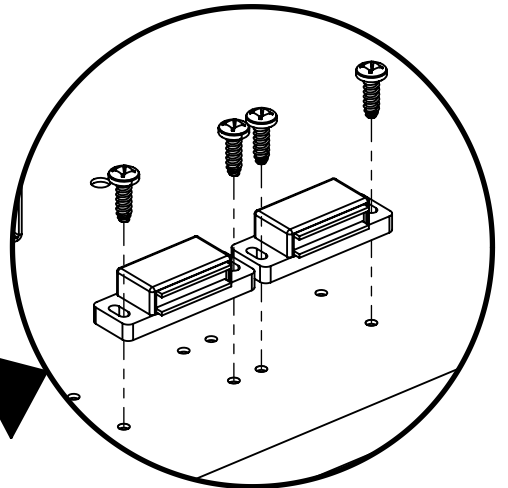
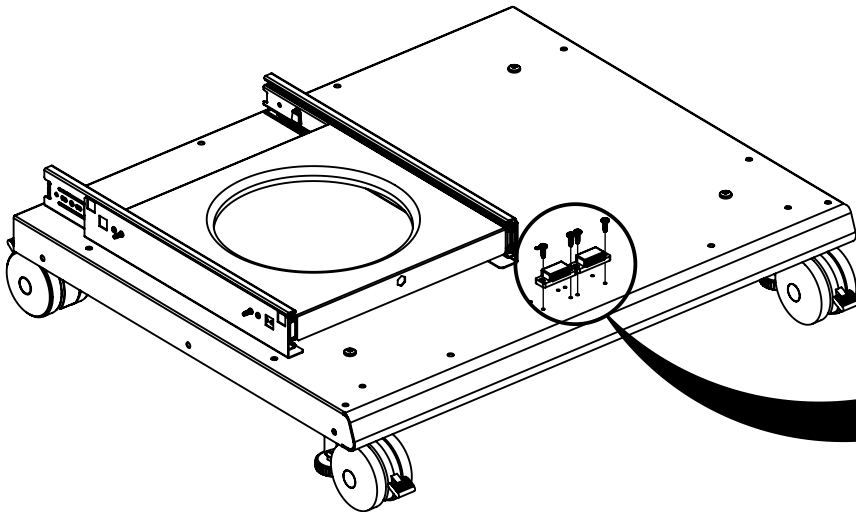
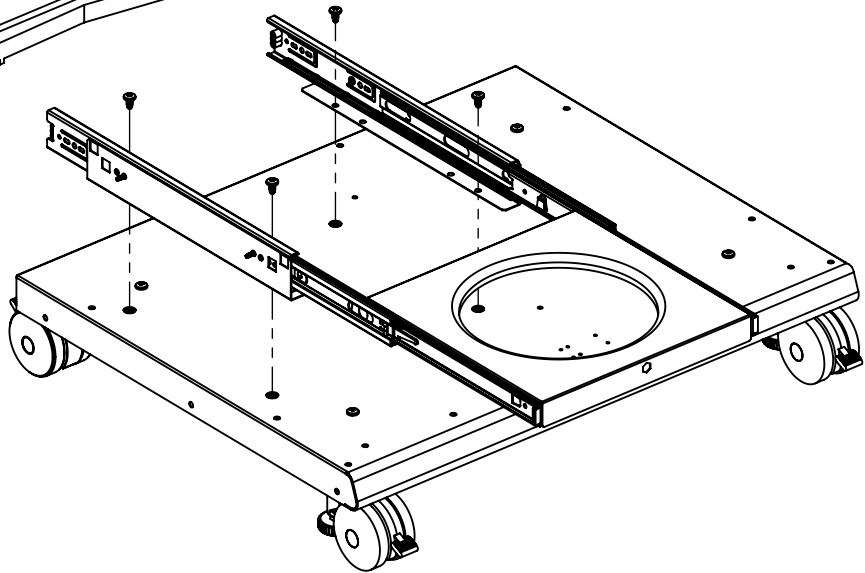
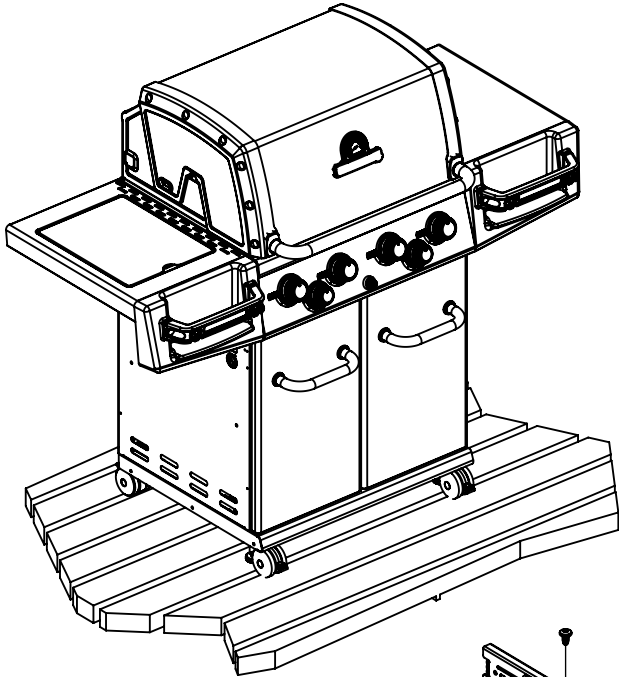
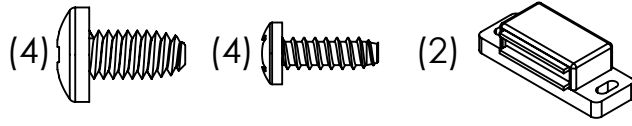

2

(2)



(2)

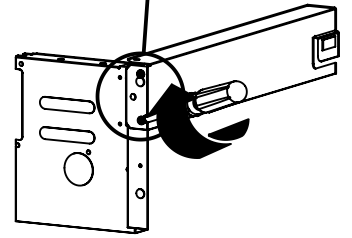
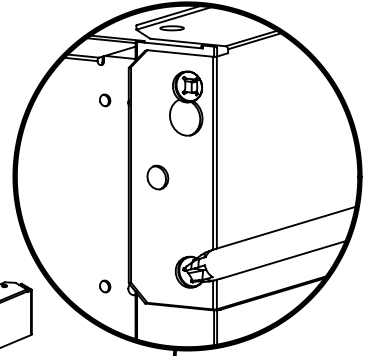
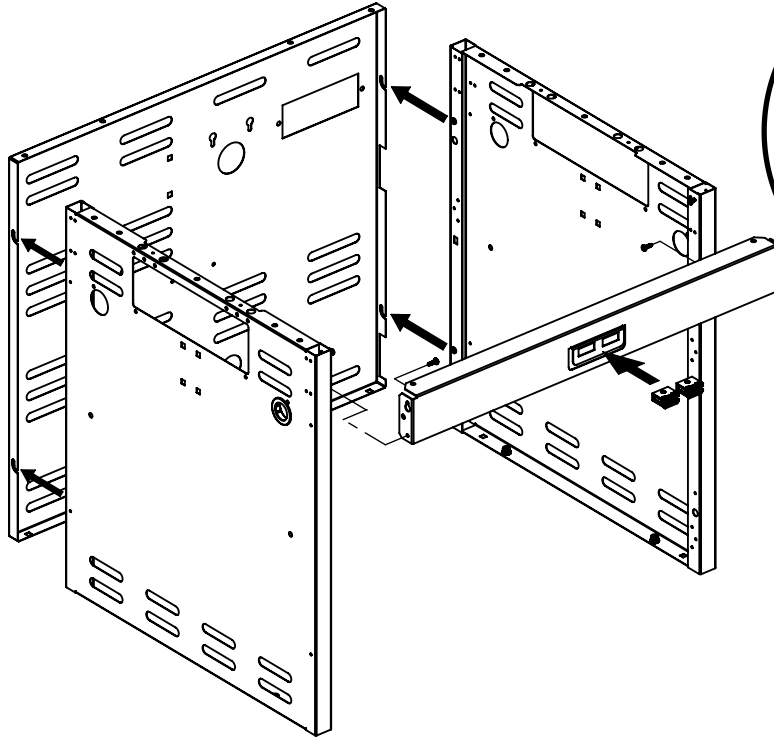
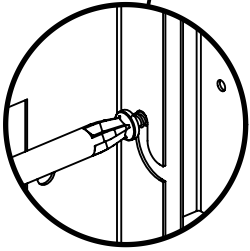
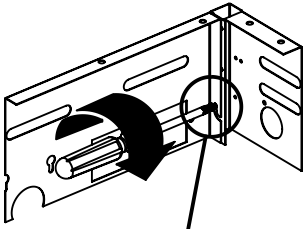

3

(4)

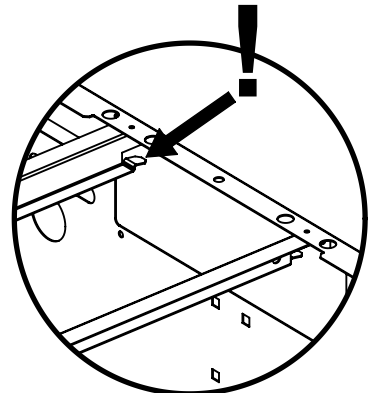
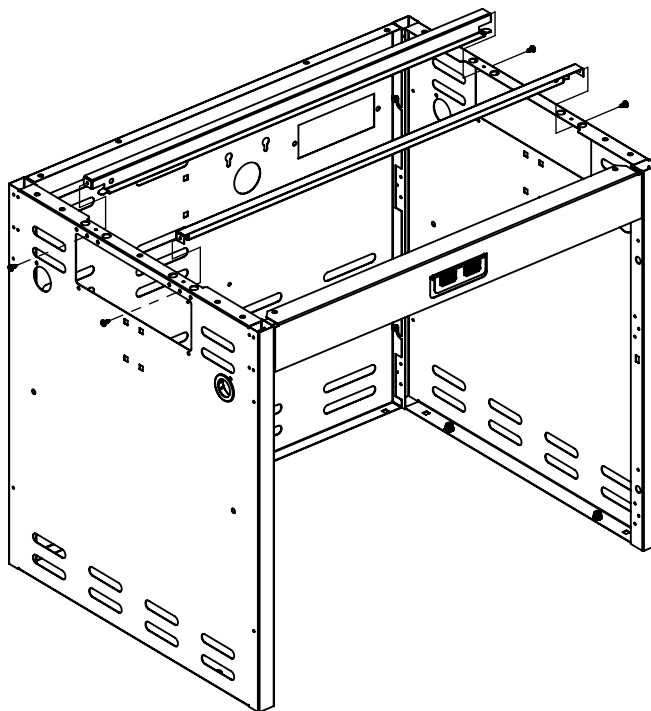
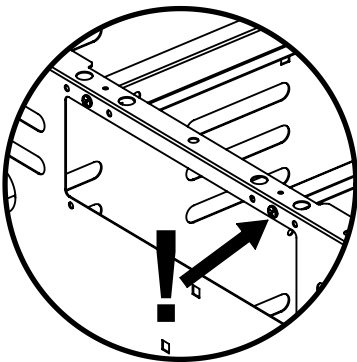
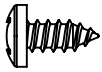

4

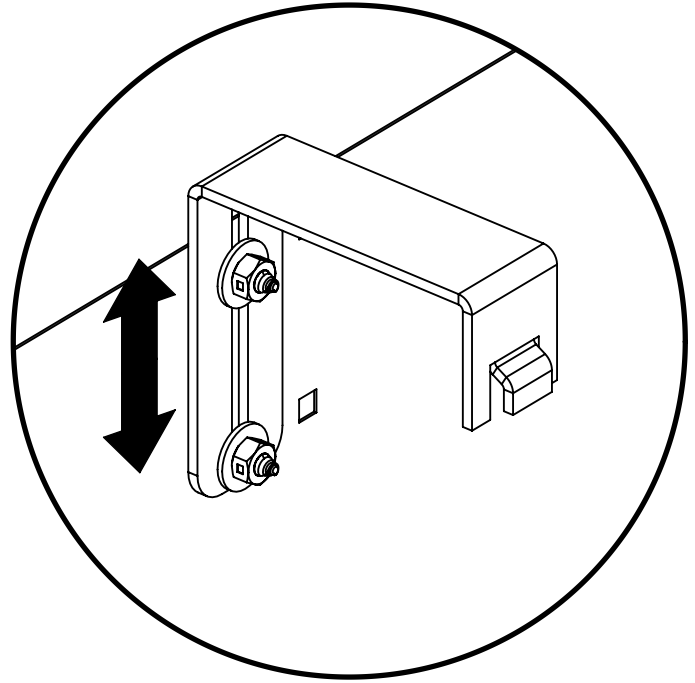
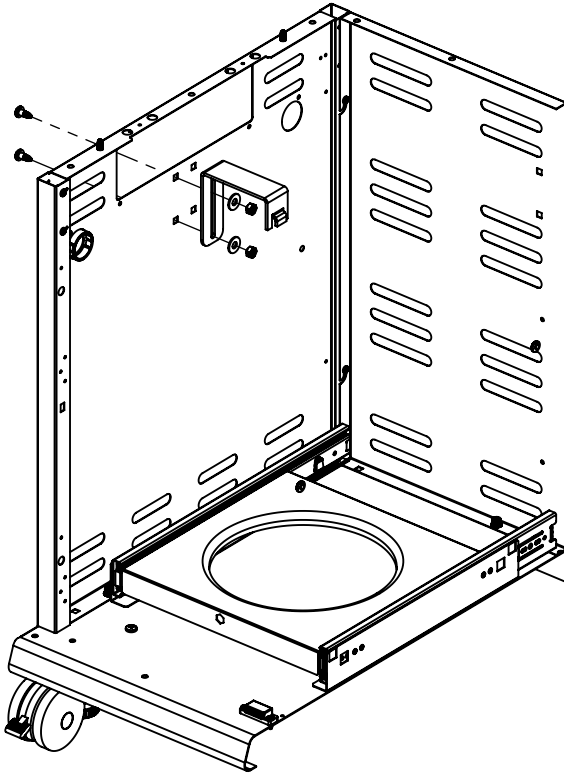
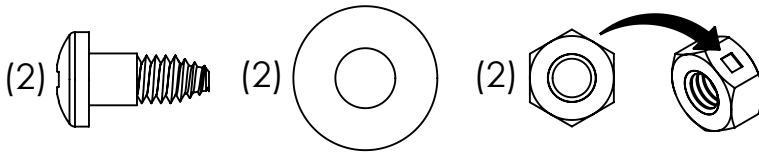

5

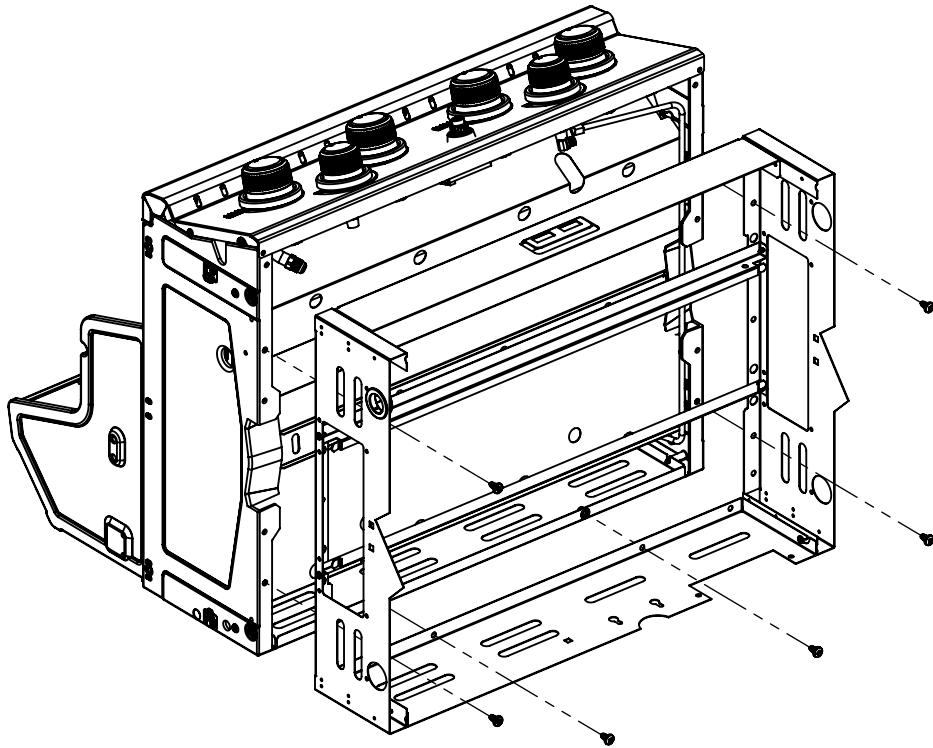
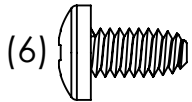

6

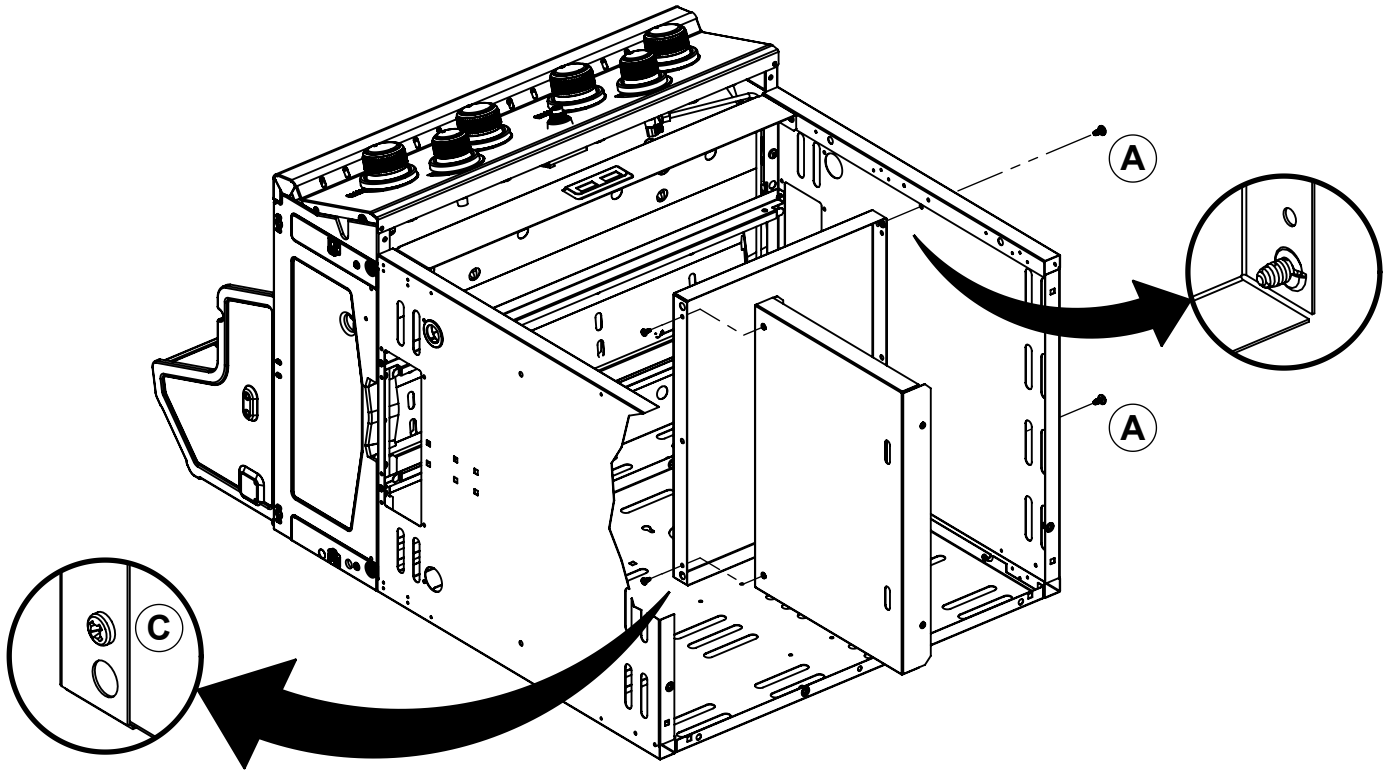
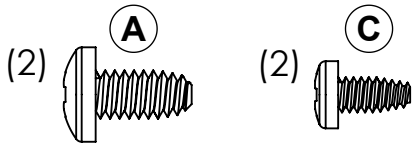

7

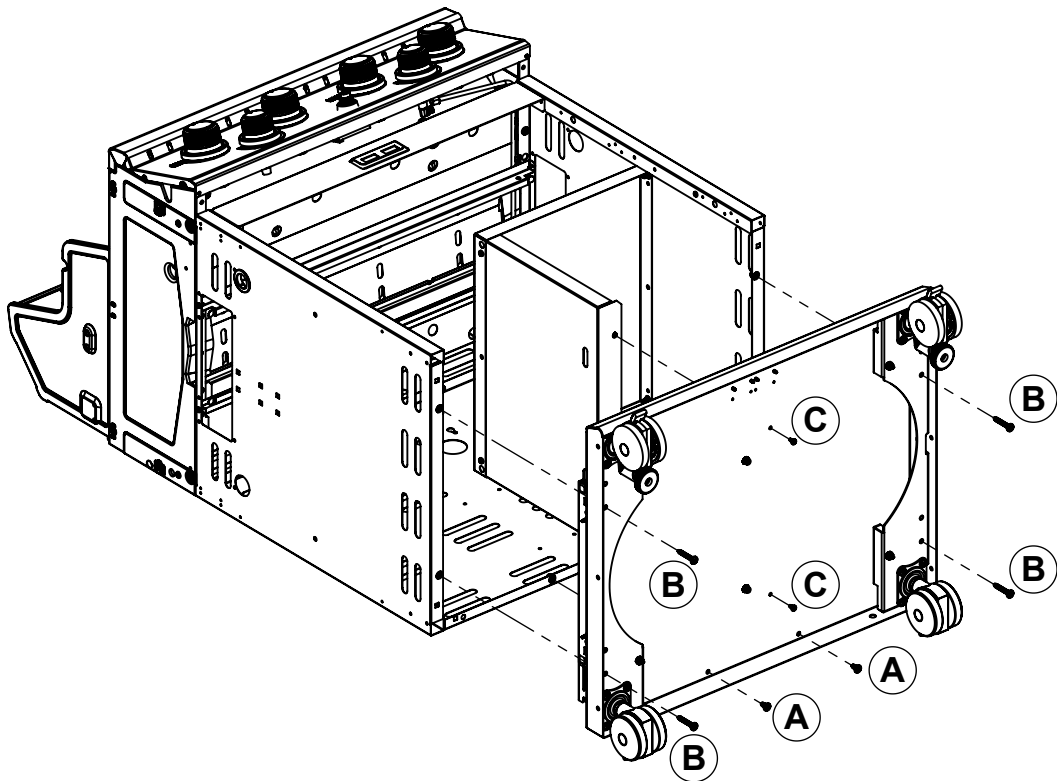
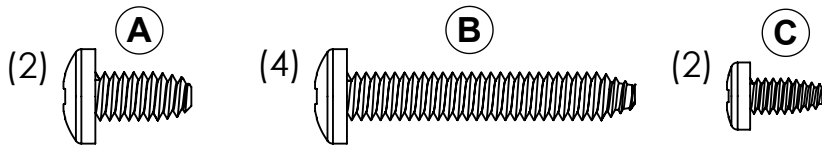

8

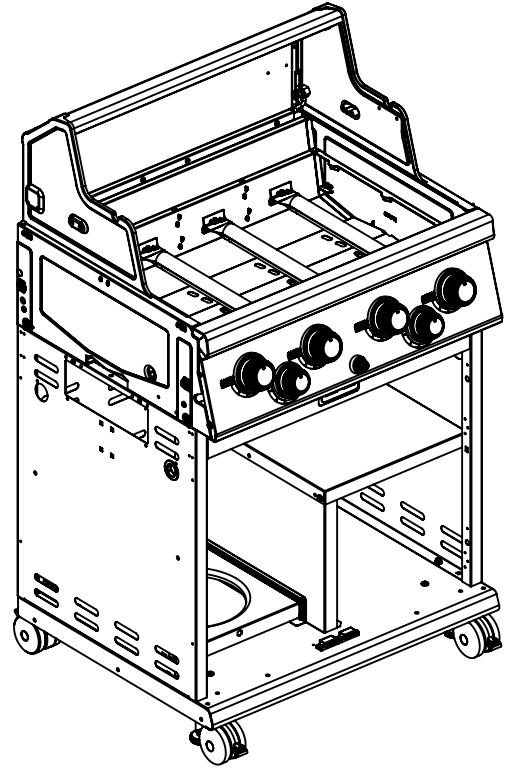
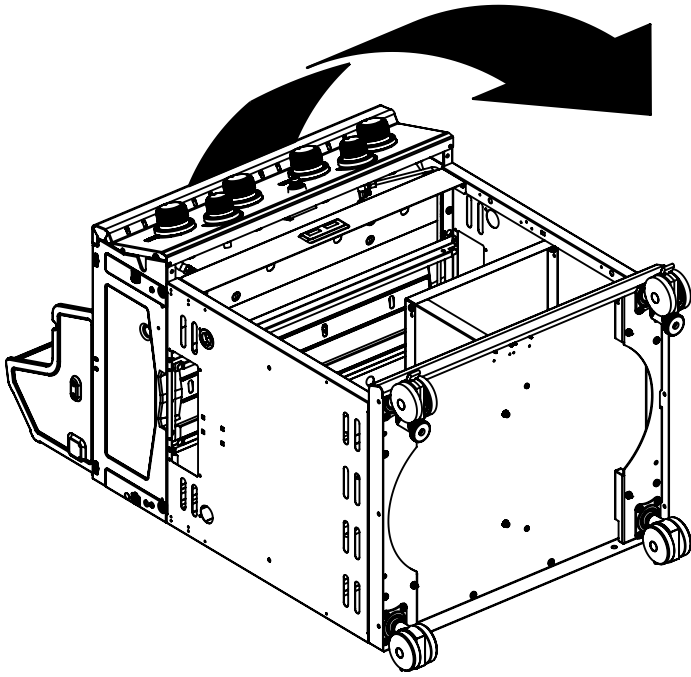
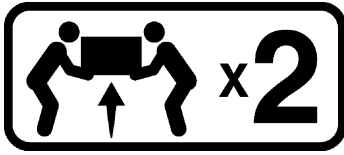

9

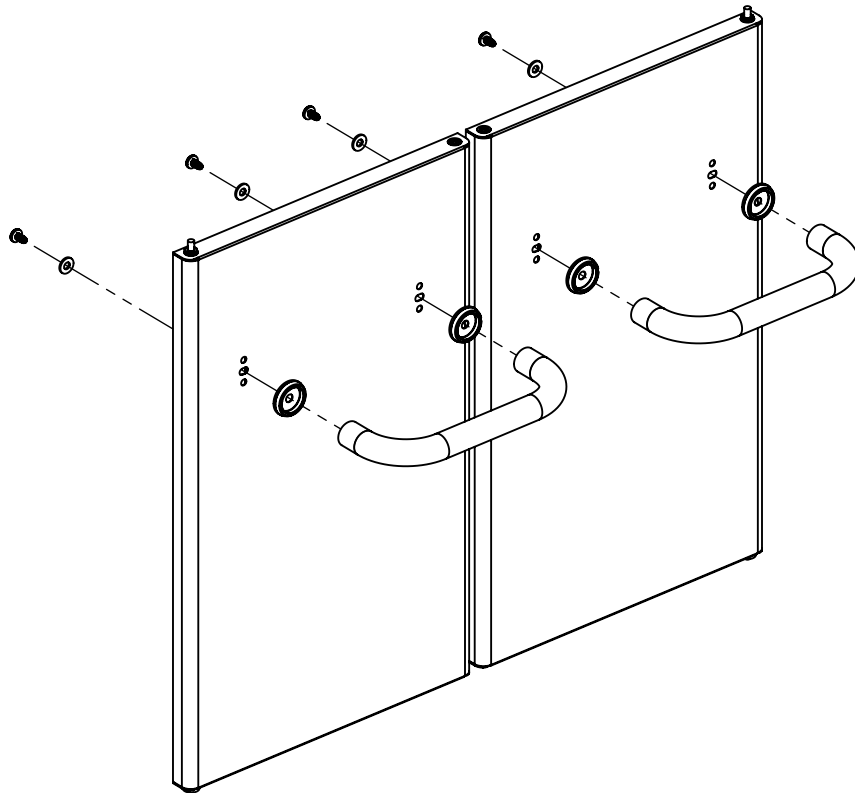
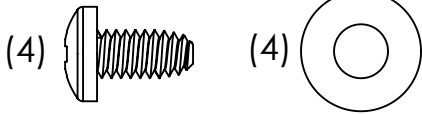

10

(2)

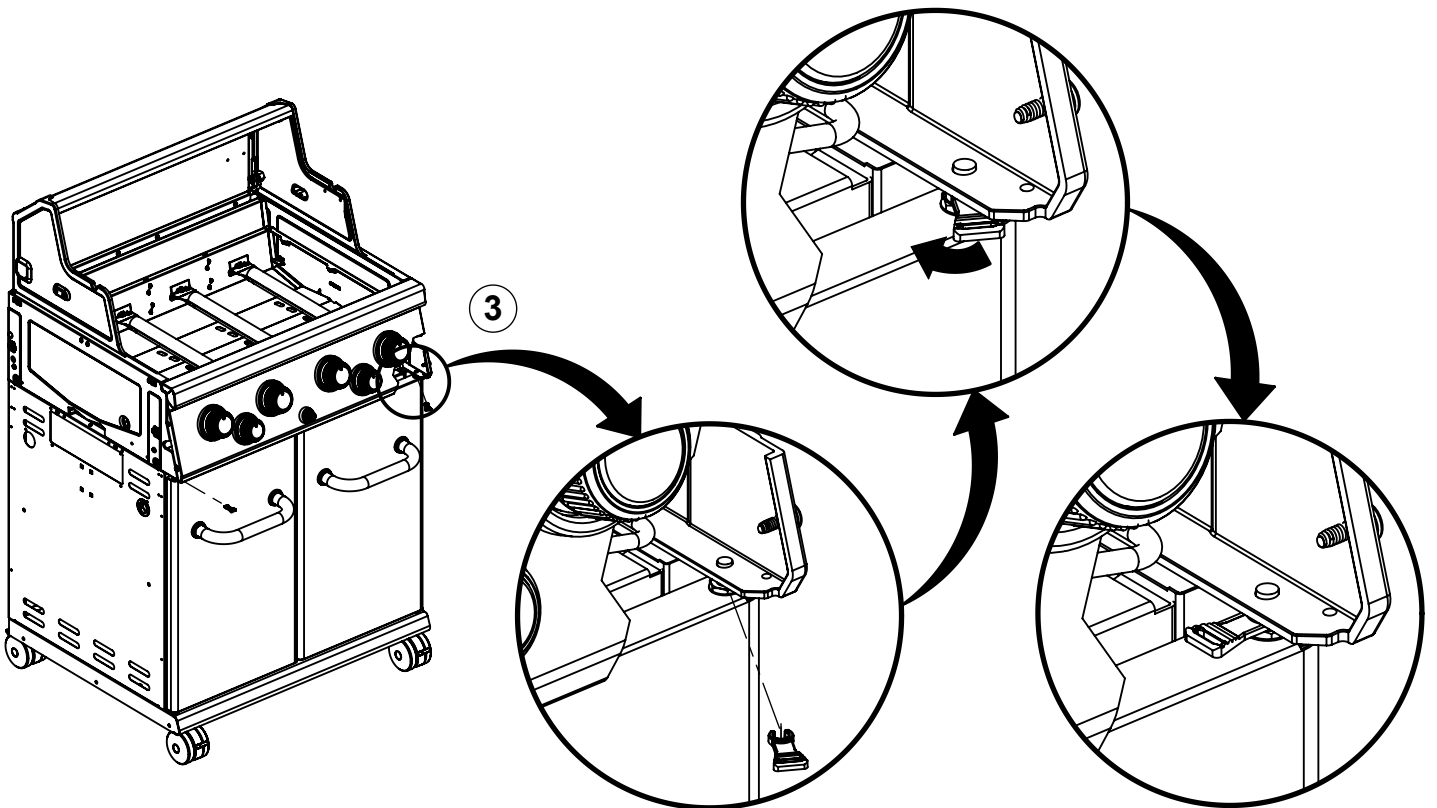
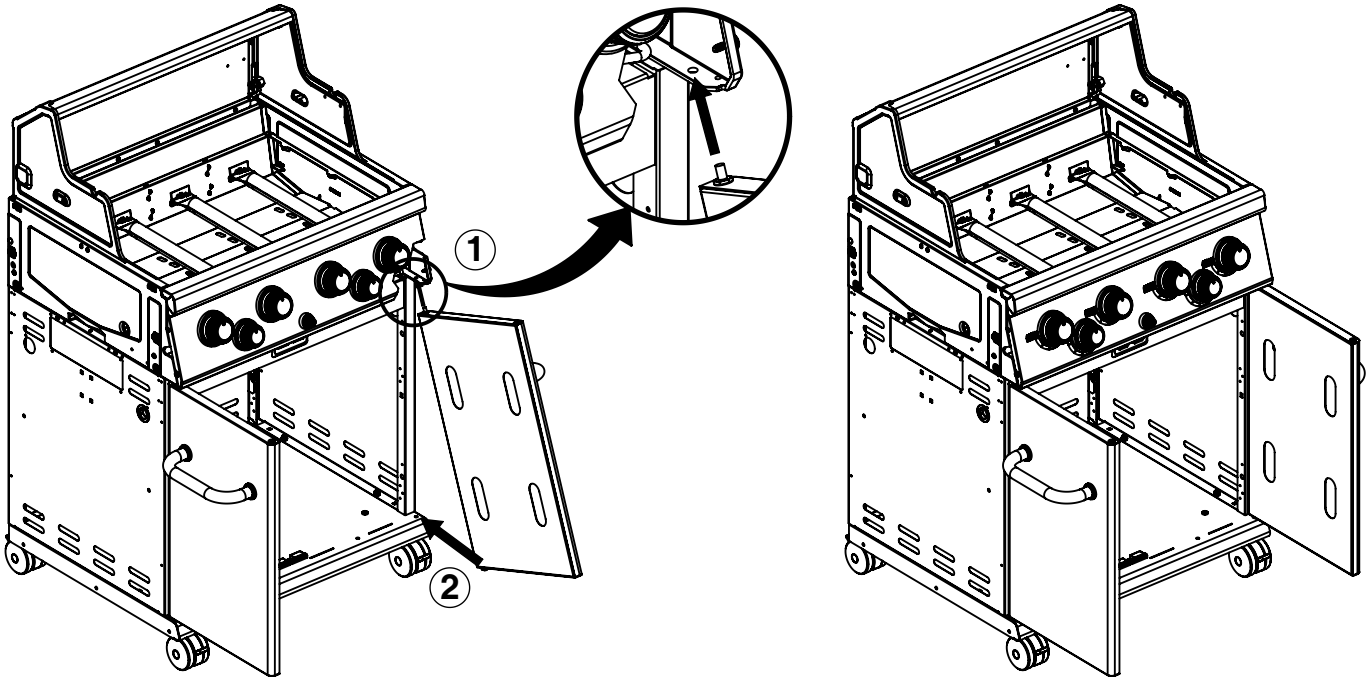
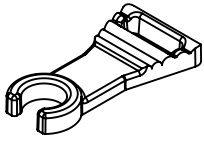

11

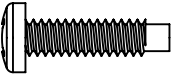
(2) 

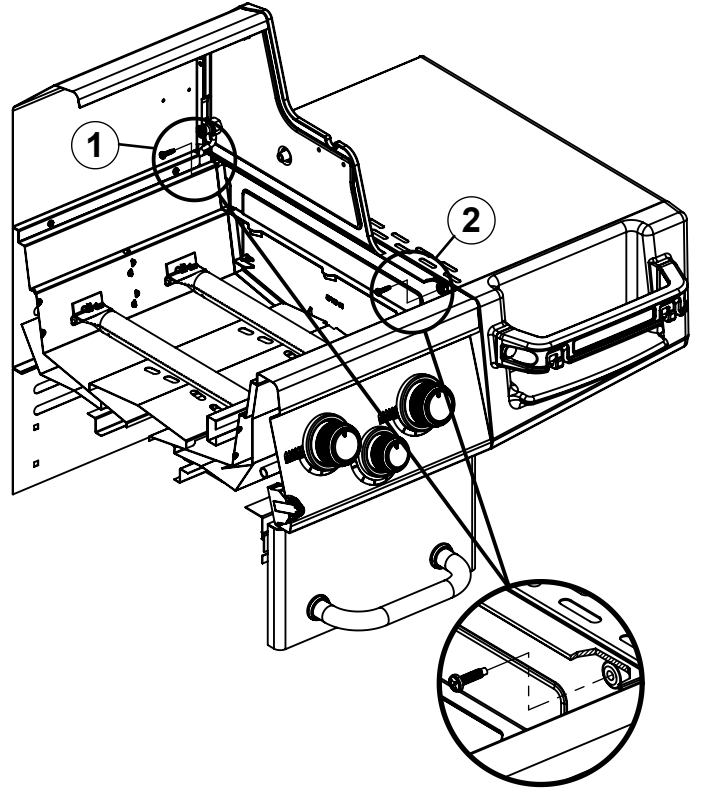
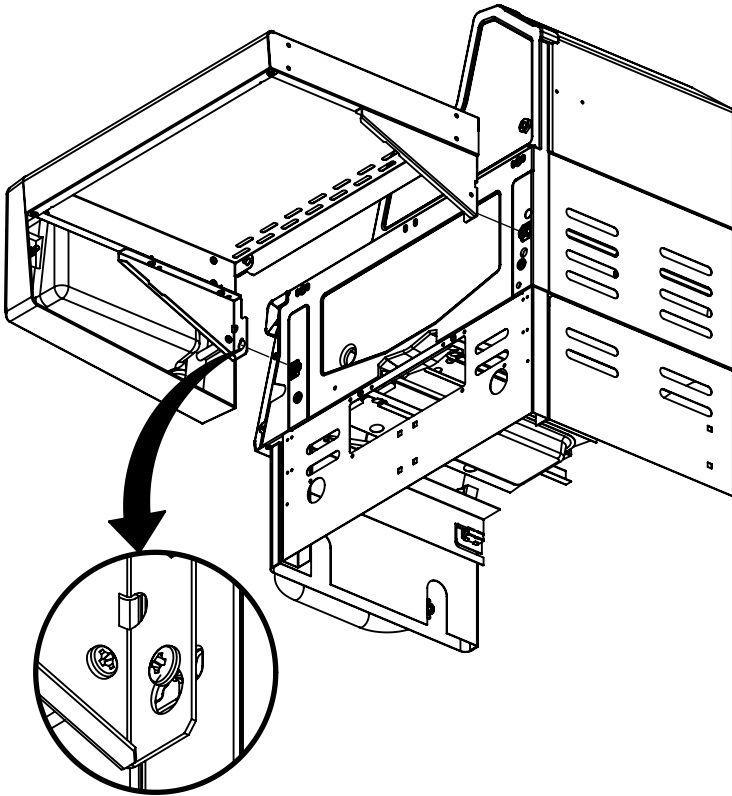

12

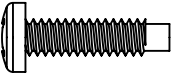
(2) 

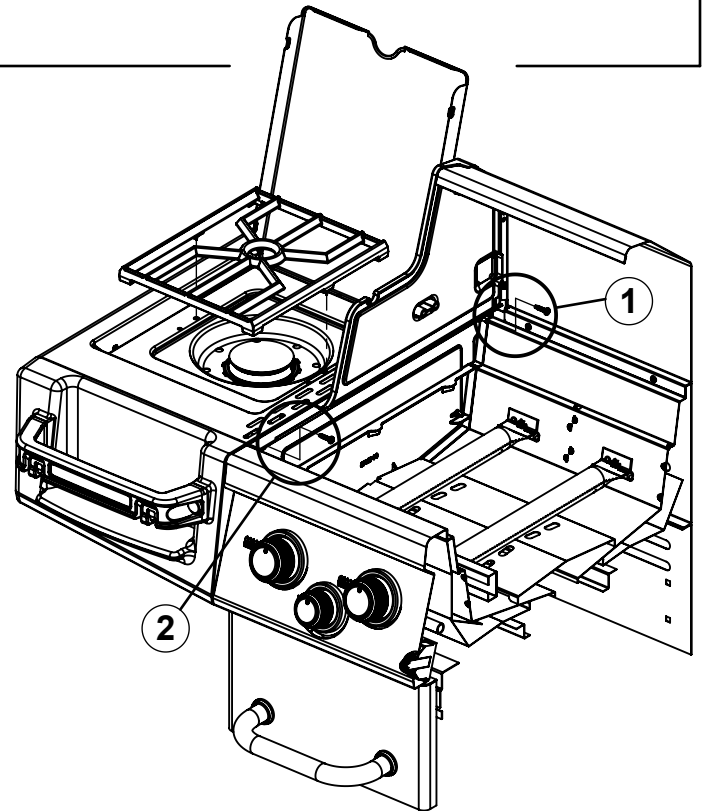
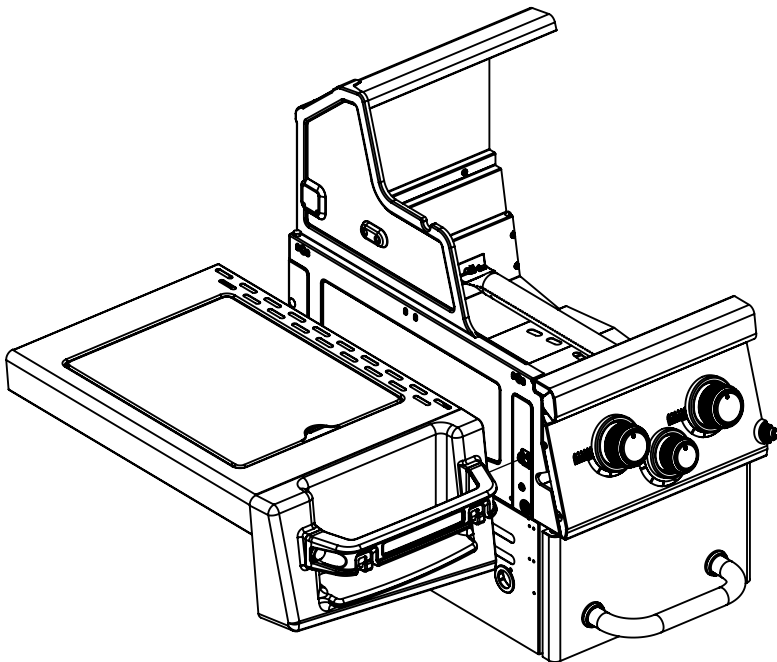

13

(1)

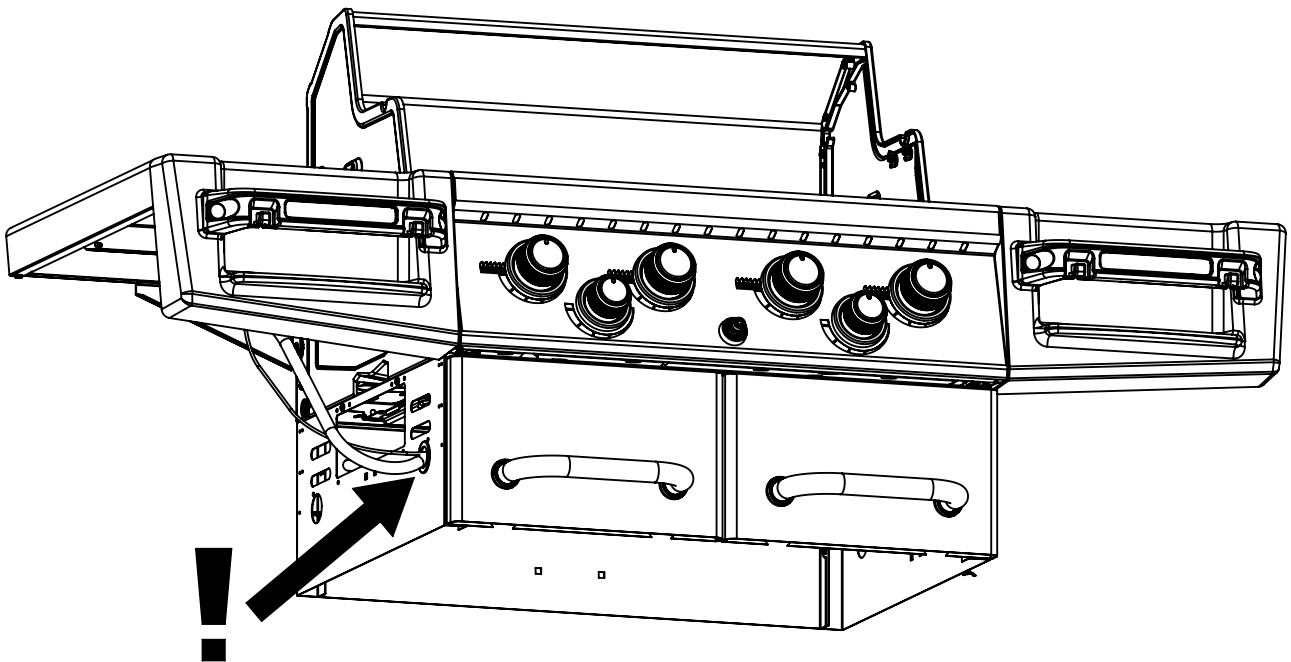
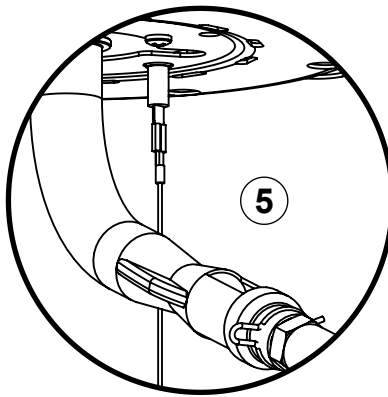
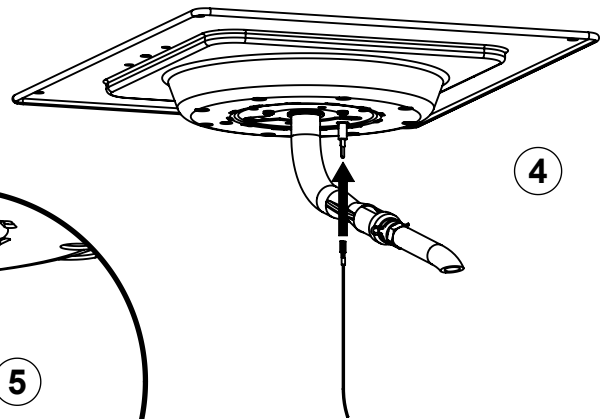
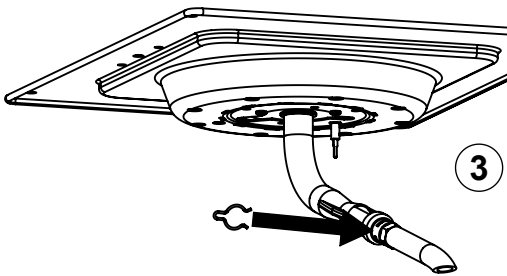
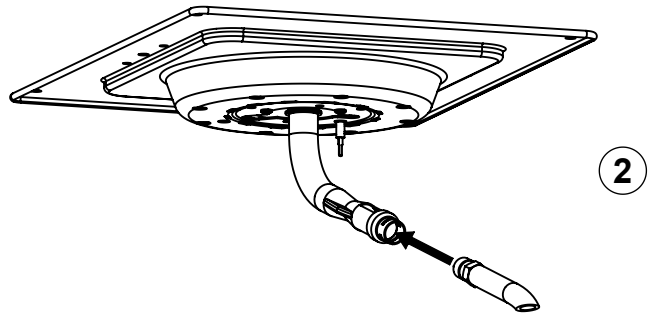
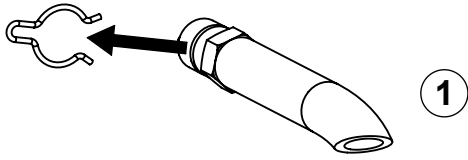
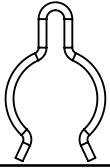

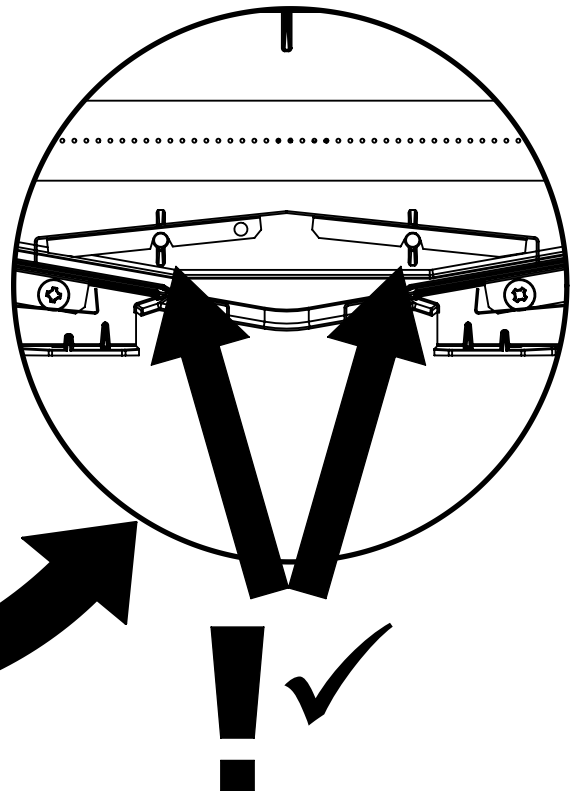
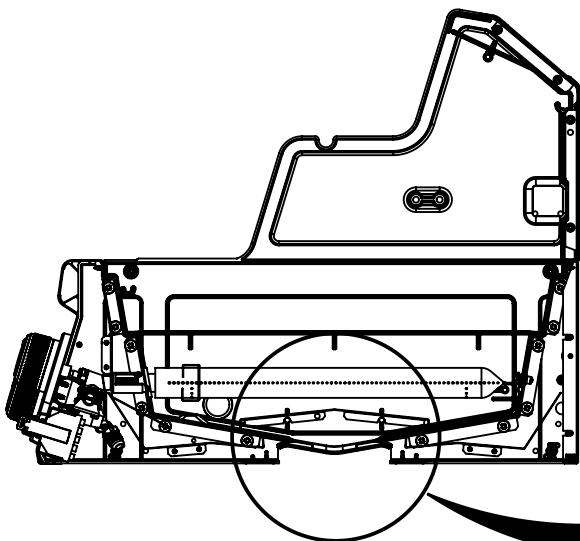
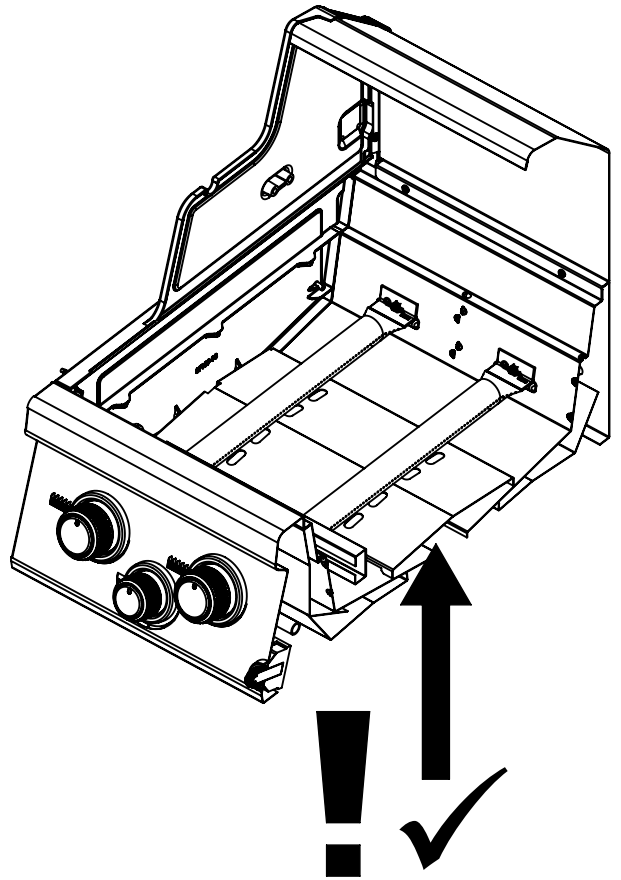
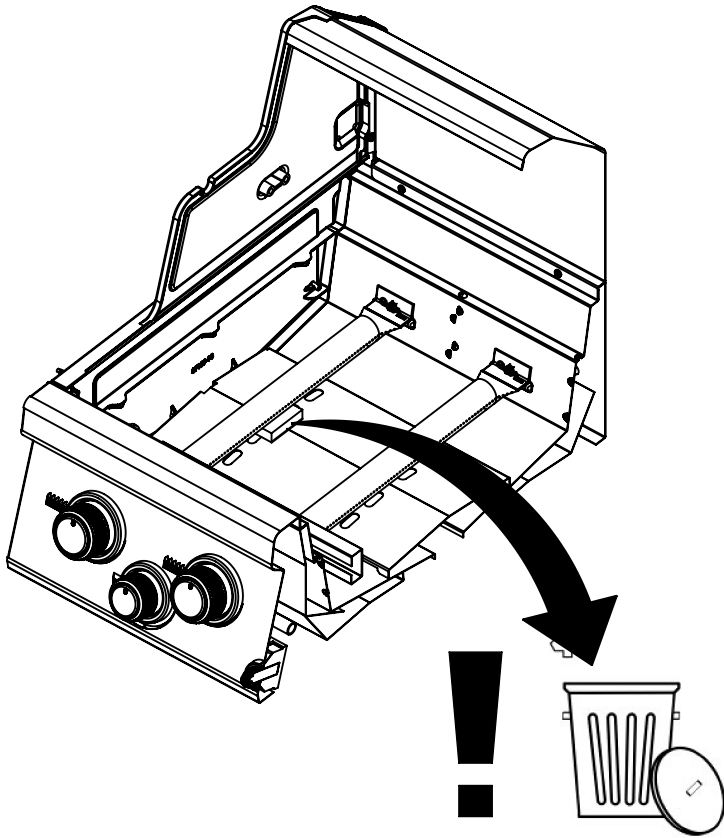

15

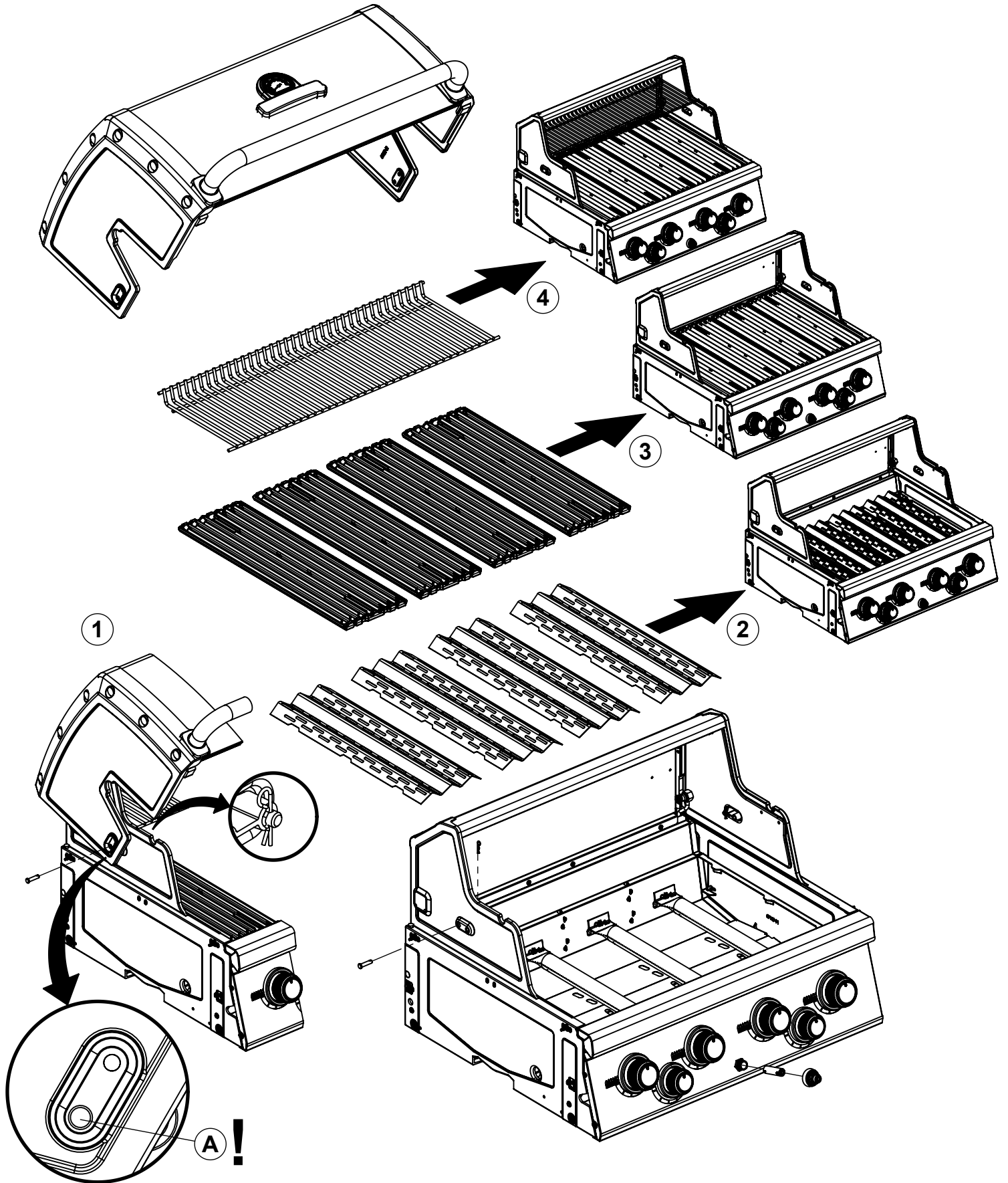
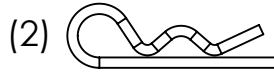
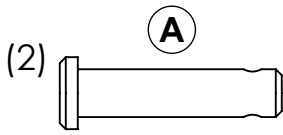

16

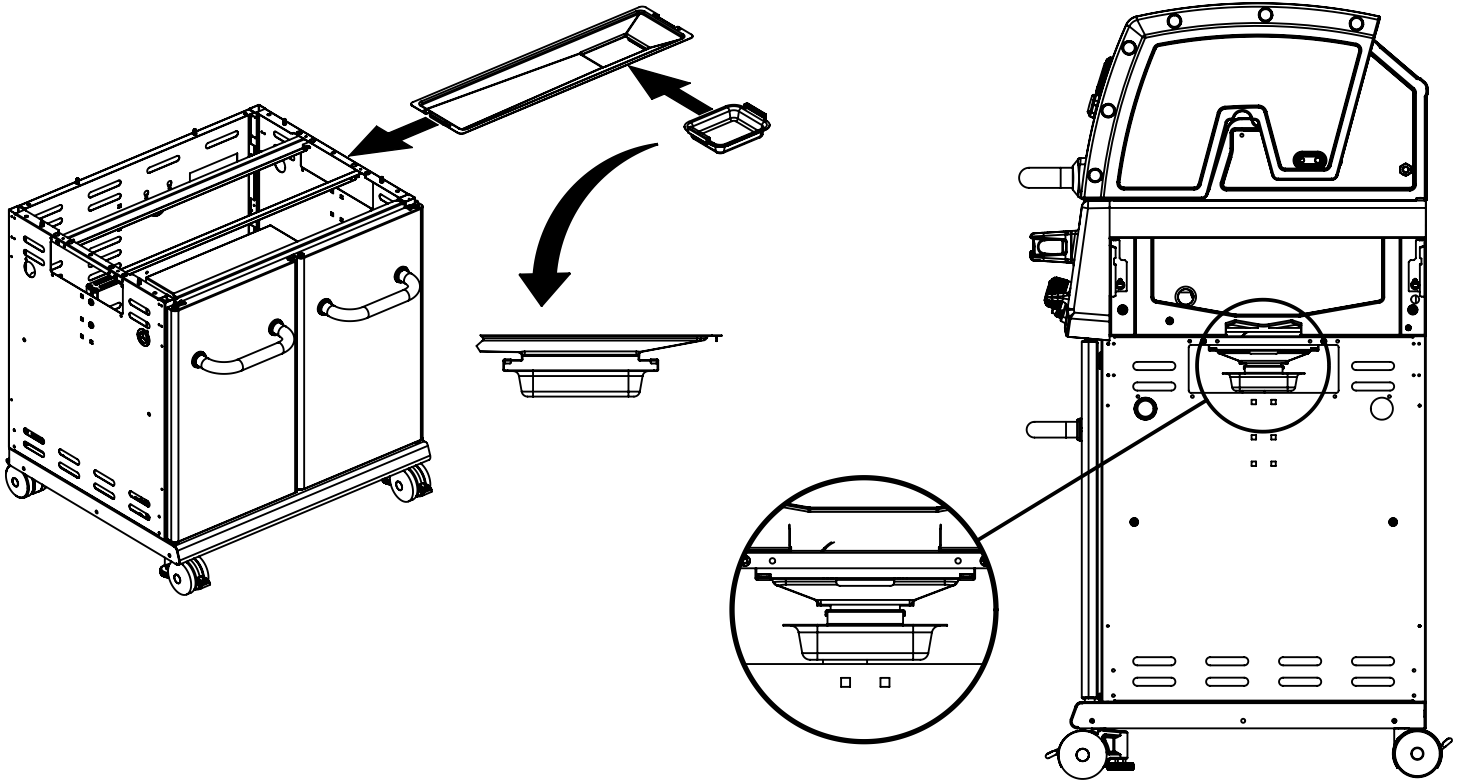

17

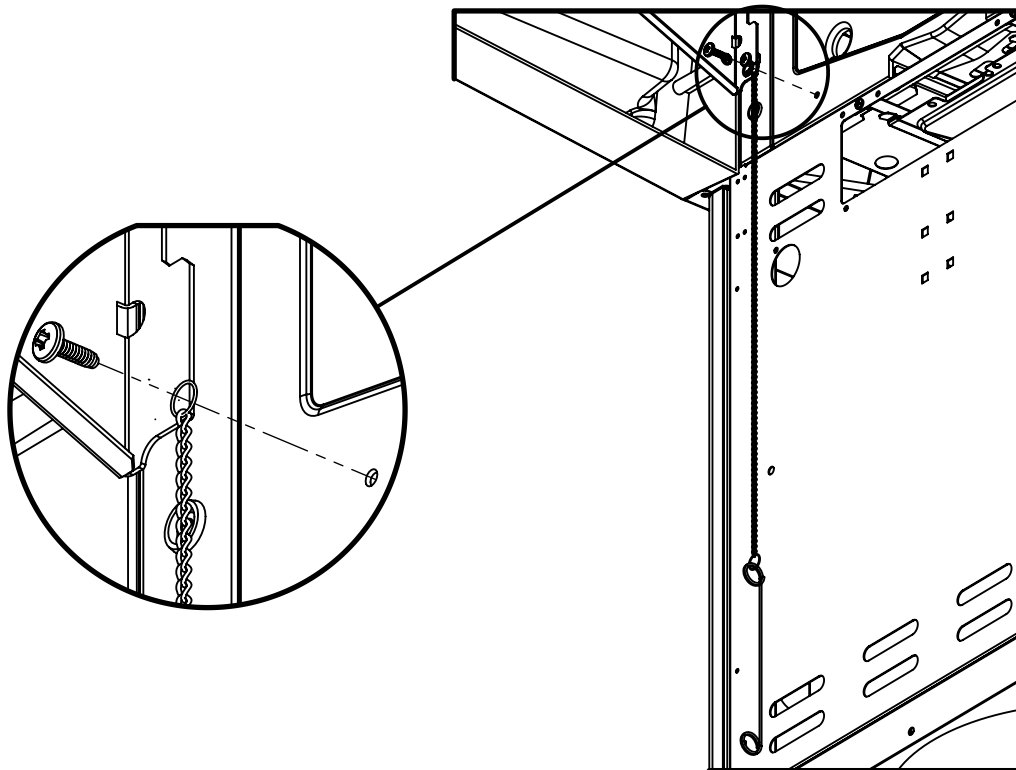
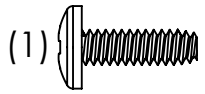

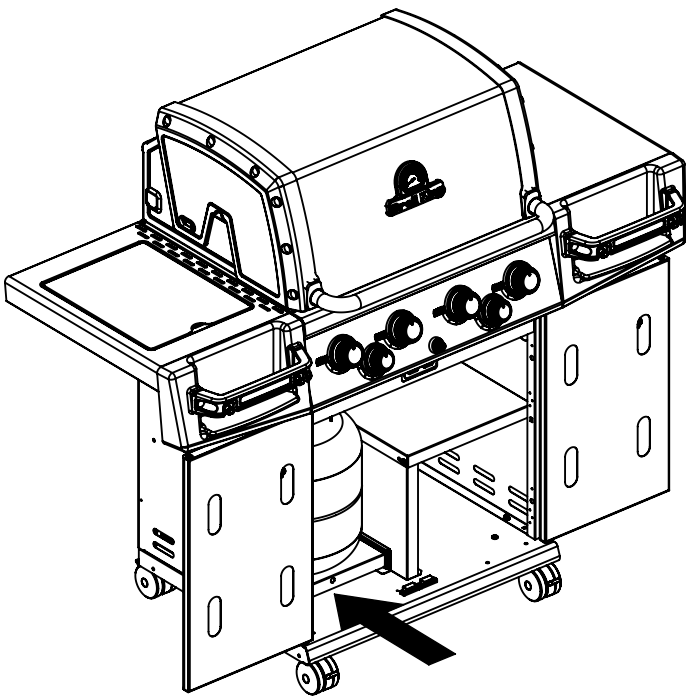
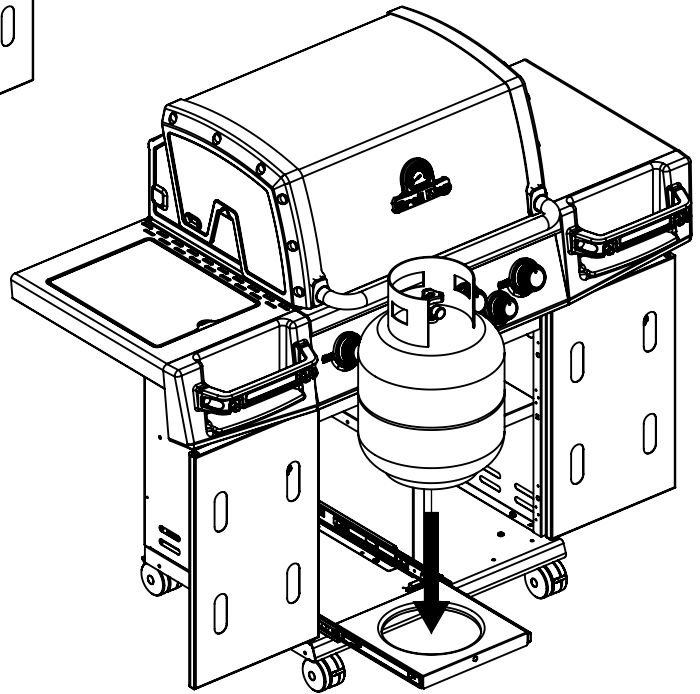
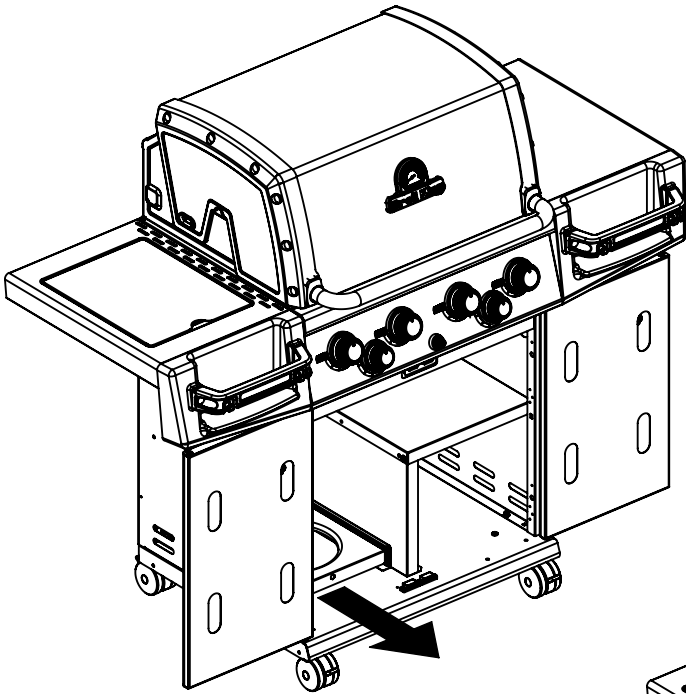

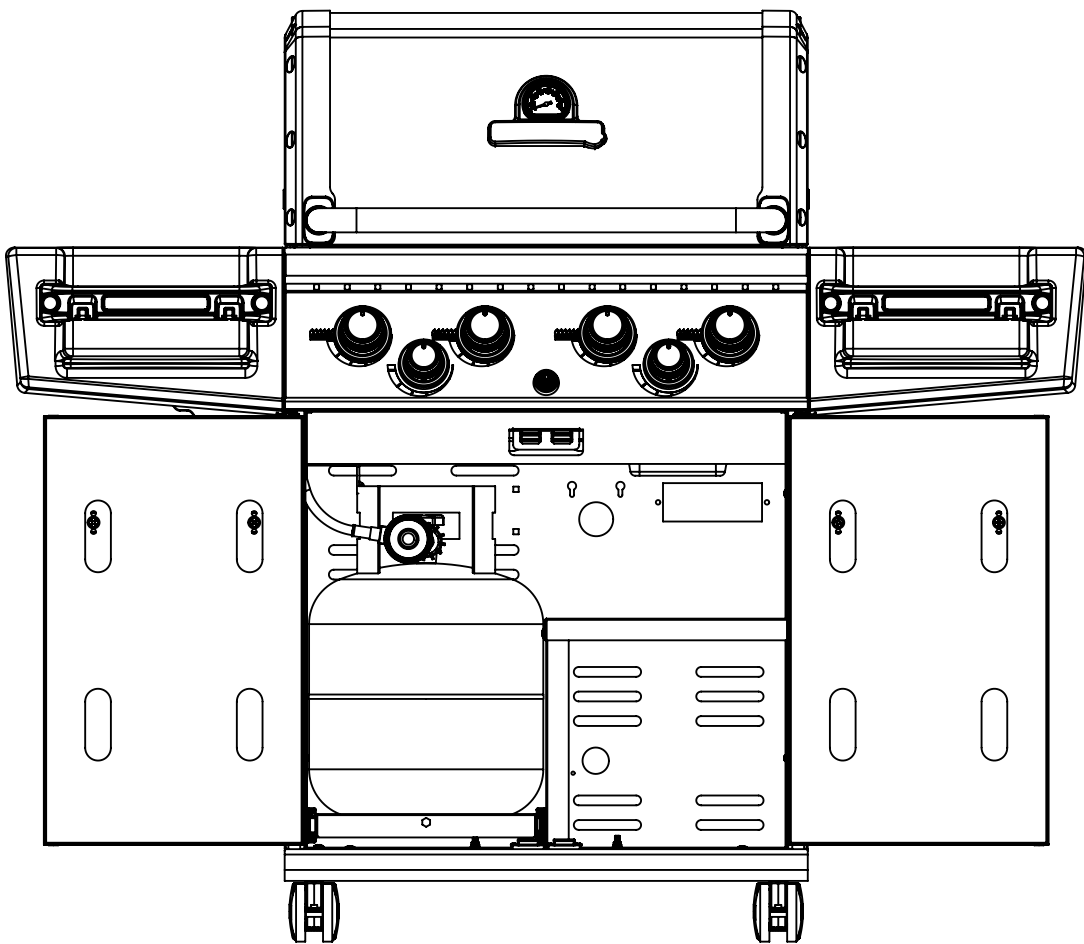
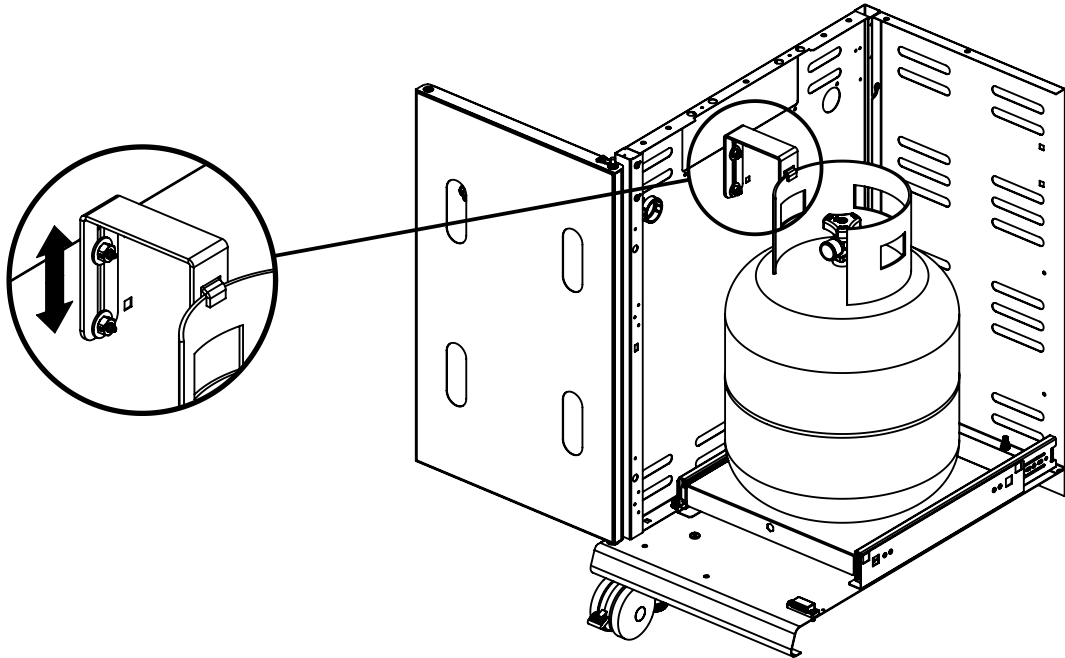

20

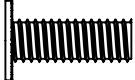
(2)  (2) 