

This Owner's Manual is provided and hosted by [Appliance Factory Parts](#).



MAGIC CHEF EWCIM65S Owner's Manual

[Shop genuine replacement parts for MAGIC CHEF
EWCIM65S](#)



[Find Your MAGIC CHEF Refrigerator Parts - Select From 316 Models](#)

----- Manual continues below -----

Automatic Ice Maker

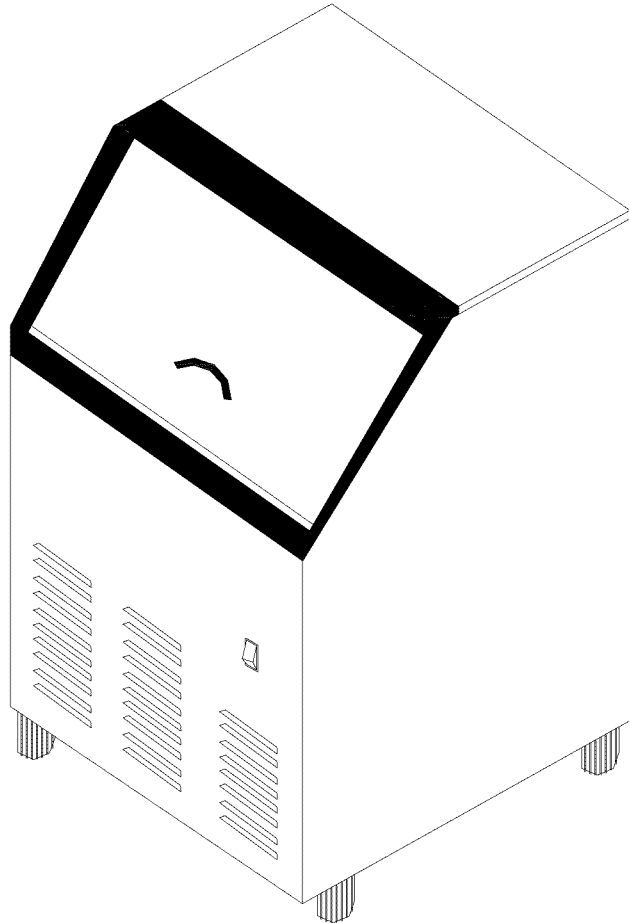

User's Manual

Be sure ice maker is standing upright 24 hours prior to plug-in.

Model: EWCIM65S, EWCIM90S, EWCIM120S

TABLE OF CONTENTS

	Page
ICE MAKER SAFETY.....	2
IMPORTANT SAFEGUARDS.....	3 - 5
TECHNICAL INFORMATION.....	5
INTRODUCTION.....	6
COMPONENT LOCATIONS.....	7
ICE MAKER INSTALLATION.....	8 - 16
Unpacking.....	8
Location Requirements.....	9
Electrical Requirements.....	10 - 11
Leveling the Ice Maker.....	11
Water Supply and Drain Connections.....	12-13
Installation Types.....	14-15
OPERATION.....	15 - 18
Final Checklist before Operation.....	15
Operating Method.....	16
How the Machine Makes Ice.....	16-17
Normal Sounds.....	17-18
Preparing the Ice Maker for Long Storage.....	18
CLEANING AND MAINTENANCE.....	18-27
Exterior Cleaning.....	19-21
Condenser Cleaning.....	20
Interior Cleaning.....	20
Ice Making System Cleaning.....	23
Control Box.....	25
Major function.....	26
TROUBLESHOOTING.....	27-30

We reserve the right to make changes in specifications and design without prior notice.

ICE MAKER SAFETY

Your safety and the safety of others are very important.

We have provided many important safety messages in this manual and on your appliance. Always read and obey all safety messages.



This is the Safety Alert Symbol. This symbol alerts you to potential hazards that can kill or injure you and others. All safety messages will follow the Safety Alert Symbol and either the words "DANGER", "WARNING" or "CAUTION".

! DANGER !

Danger means that failure to heed this safety statement may result in severe personal injury or death.

! WARNING

Warning means that failure to heed this safety statement may result in extensive product damage, serious personal injury, or death.

CAUTION

Caution means that failure to heed this safety statement may result in minor or moderate personal injury, or property or equipment damage.

All safety messages will alert you to what the potential hazard is, tell you how to reduce the chance of injury, and let you know what can happen if the instructions are not followed.

IMPORTANT SAFEGUARDS



Before the ice maker is used, it must be properly positioned and installed as described in this manual, so read the manual carefully. To reduce the risk of fire, electrical shock or injury when using the ice maker, follow basic precautions, including the following:

DANGER

- Plug into a grounding outlet, do not use an adapter, and do not use an extension cord.
- It is recommended that a separate circuit, serving only your ice maker, be provided. Use receptacles that cannot be turned off by a switch or pull chain.
- Do not connect or disconnect the electric plug when your hands are wet.
- Never clean ice maker parts with flammable fluids. These fumes can create a fire hazard or explosion. And do not store or use gasoline or other flammable vapors and liquids in the vicinity of this or any other appliance. The fumes can create a fire hazard or explosion.
- Before proceeding with cleaning and maintenance operations, make sure the power line of the unit is disconnected and the water line is shut off (EXCEPTION: ice maker system's cleaning).
- Replace all panels before operating after servicing or maintenance.
- Unplug the ice maker or disconnect power before cleaning or servicing. Failure to do so can result in electrical shock or death.
- Do not attempt to repair or replace any part of your ice maker unless it is specifically recommended in this manual. All other servicing should be referred to a qualified technician.

WARNING

- When you disassemble the front cover, don't overexert, or the leads connected with the power switch can be torn down.
- Use two or more people to move and install ice maker. Failure to do so can result in back or other injury.
- To ensure proper ventilation for your ice maker, the front of the unit must be completely unobstructed. Choose a well-ventilated area with temperatures above 13°C and below 32°C. This unit MUST be installed in an area protected from the elements, such as wind, rain, water spray or drips.
- The ice maker should not be located next to ovens, grills or other sources of high heat.
- The ice maker must be installed with all electrical, water and drain connections in accordance with state and local codes. A standard electrical supply (115VAC, 60Hz, 15A), properly grounded in accordance with the National Electrical Code

and local codes and ordinances is required.

- Do not kink or pinch the power supply cord between the ice maker and cabinet.
- The appliance is to be connected to the water mains using new hose-set and that old hose-sets should not be reused.
- If the supply cord is damaged, it must be replaced by the manufacturer, its service agent or similar qualified person in order to avoid a hazard.
- The plug must be accessible after installation.
- All horizontal runs of drain lines must have a fall of 2cm per meter.
- It is important for the ice maker to be leveled in order to work properly. You may need to make several adjustments to level it.
- All installations must be in accordance with local plumbing code requirements.
- Make certain that the pipes are not pinched or kinked or damaged during installation.
- Check for leaks after water line and drain line connection.
- Never allow children to operate, play with or crawl inside the ice maker.
- Although the unit has been tested at the factory, due to long-term transit and storage, the first batch of cubes must be discarded.
- Never turn the water supply tap off when the ice maker is working.
- If the ice maker will not be used for a long time, before the next use it must be thoroughly cleaned. Follow carefully any instructions provided for cleaning or use of sanitizing solution. Do not leave any solution inside the ice maker after cleaning.
- DO NOT touch the condenser fins. The condenser fins are sharp and can be easily damaged.
- DO NOT use solvent-based cleaning agents or abrasives on the interior. These cleaners may transmit taste to the ice cubes, or damage or discolor the interior.
- The ice machine cleaner contains acids. DO NOT use or mix with any other solvent-based cleaner products. Use rubber gloves to protect hands. Carefully read the material safety instructions on the container of the ice machine cleaner.
- Do not use this apparatus for other than its intended purpose.

SAVE THESE INSTRUCTIONS

Electrical Connection

For personal safety, this appliance must be properly grounded. The power cord of this appliance is equipped with a grounding plug that mates with a standard grounding wall outlet to minimize the possibility of electric shock hazard from the appliance. Have the wall outlet and circuit checked by a qualified electrician to make sure the outlet is properly grounded. When a standard 2-prong wall outlet is encountered, it is your responsibility and obligation to have it replaced with a properly grounding wall outlet. The ice maker should always be plugged into its own individual electrical outlet which has a voltage rating that matches the rating label on the appliance. This provides the best performance and also prevents

overloading house wiring circuits which could cause a fire hazard from overheated wires. Never unplug your ice maker by pulling on the power cord. Always grip the plug firmly and pull straight out from the outlet. Repair or replace immediately all power cords that have become frayed or otherwise damaged. Do not use a cord that shows cracks or abrasion damage along its length or at either end. When moving the ice maker, be careful not to damage the power cord.

Extension Cord

Because of potential safety hazards under certain conditions, it is strongly recommended that you do not use an extension cord with this ice maker.

IMPORTANT SAFETY INSTRUCTIONS	
WARNING: To reduce the risk of fire, electric shock, or injury when using your ice maker, follow these basic precautions:	
<ul style="list-style-type: none"> ● Plug into a grounding wall outlet. ● Do not remove grounding prong. ● Do not use an adapter. ● Do not use an extension cord. ● Disconnect power before cleaning. ● Disconnect power before servicing. 	<ul style="list-style-type: none"> ● Replace all panels before operating. ● Use two or more people to move and install ice maker.
SAVE THESE INSTRUCTION	

TECHNICAL INFORMATION

Model	AZ-36	AZ-45	AZ-56
Rated Power	115VAC~60Hz	115VAC~60Hz	115VAC~60Hz
Ice-making rated current	6.7A	7.3A	7.5A
Ice-harvst rated current	11.2A	11.7A	11.8A
Refrigerant	R134a/6.88oz	R134a/8.96oz	R134a/9.92oz
High Side Pressure	320psi	320psi	320psi
Low Side Pressure	120psi	120psi	120psi
Max hydraulic pressure	0.5Mpa	0.5Mpa	0.5Mpa
Width*depth*height	424*536*827	561*536*827	561*536*827
Ice-making capacity	65 lbs/day*	83 lbs/day*	110 lbs/day*
Unit weight	42kg	48kg	46kg

Circuit Diagram

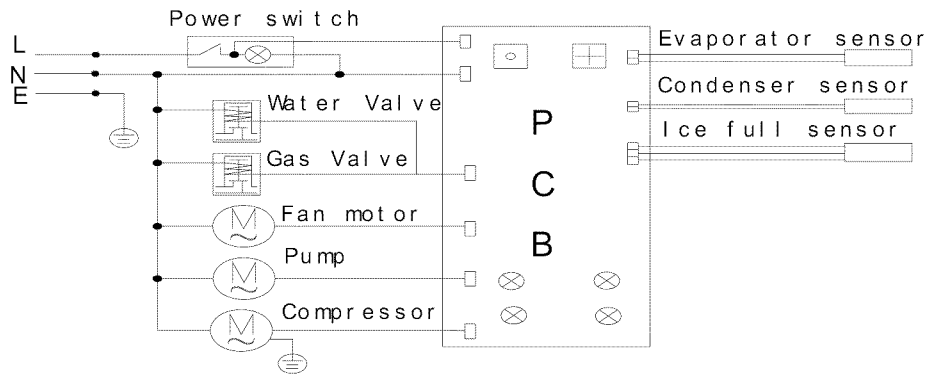

The technical data and performance index listed above should be used for reference only. They are subject to change.

*The actual quantity of ice produced per day can vary with room and water conditions.

INTRODUCTION

AZ series Ice Maker finds wide application in households, bars, restaurants, hotels, supermarkets, etc. It produces crystal-clear, gourmet cube ice, and offers convenience for homeowners and hotel guests. An insulated ice storage bin is built into the ice maker.

This user's manual is intended as a resource for persons installing, using and servicing the AZ series. It contains valuable information on safety and maintenance. My company strongly recommends that this manual be kept in a place where it can be accessed when needed.

The ice maker is designed and manufactured according to the highest standards of safety and performance.

My company assumes no liability or responsibility of any kind for products manufactured that have been altered in any way, including the use of any parts and/or other components not specifically approved by my company. My company reserves the right to make design changes and/or improvements at any time. Specifications and designs are subject to change without notice.

COMPONENT LOCATIONS

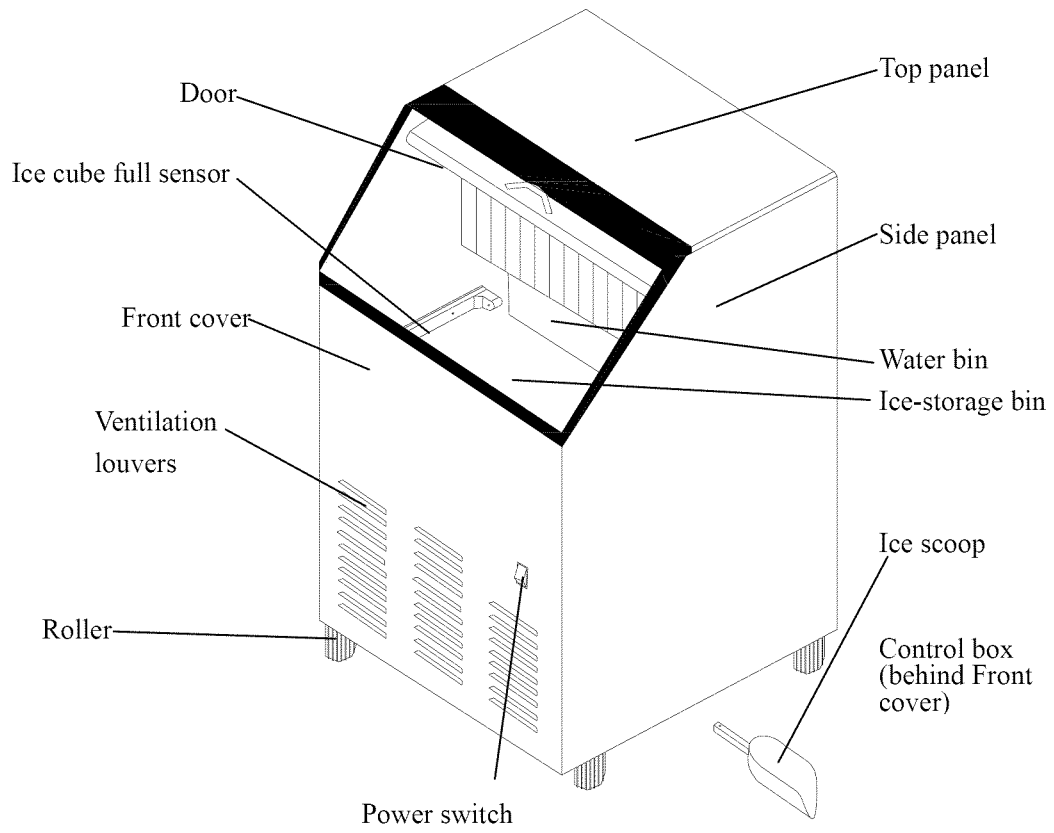

ICE MAKER INSTALLATION

Unpacking



Excessive Weight Hazard

Use two or more people to move and install ice maker. Failure to do so can result in back or other injury.

Remove packaging materials

IMPORTANT: Do not remove any permanent instruction labels or the data label on your ice maker.

Remove tape and glue from your ice maker before using.

- To remove any remaining tape or glue, rub the area briskly with your thumb. Tape or glue residue can also be easily removed by rubbing a small amount of liquid dish soap over the adhesive with your fingers. Wipe with warm water and dry.
- Do not use sharp instruments, rubbing alcohol, flammable fluids, or abrasive cleaners to remove tape or glue. These products can damage the surface of your ice maker.

Cleaning before use

After you remove all of the packaging materials, clean the inside of your ice maker before using it. See "Interior cleaning" in the Cleaning and Maintenance section.

Location Requirements

Installation clearance
top view (1:10) (mm)

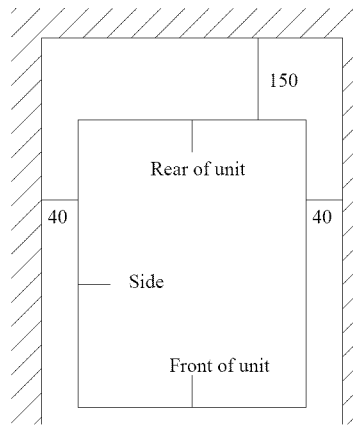

Side view (mm)

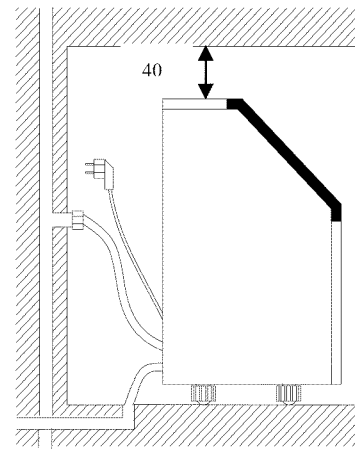

To ensure proper ventilation for your ice maker, the front of the unit must be completely unobstructed. Allow at least 150 mm clearance at rear, and 40 mm at top and sides for proper air circulation. The installation should allow the ice maker to be pulled forward for servicing if necessary.

When installing the ice maker under a counter, follow the recommended spacing dimensions shown. Place electrical and water supplies and drain fixtures in the recommended locations as shown.

Choose a well-ventilated area with temperatures above 13°C and below 32°C. This unit **MUST** be installed in an area protected from the elements, such as wind, rain, water spray or drips.

The unit should not be located next to ovens, grills or other sources of high heat. Installation of the ice maker requires a cold water supply inlet of 19mm O.D. soft copper tubing with a shut-off valve. A gravity-drain system provided with the unit can be used.

(NOTE: Runoff water can also be drained into a sink via a pump – not included – when a gravity drain is not available.)

The ice maker requires a continuous water supply with pressure between 0.1Mpa and 0.5Mpa. The temperature of the water feeding into the ice maker should be between 5°C and 25°C for proper operation.

WARNING

Normal operating ambient temperature should be between 13°C to 32°C.
Normal operating water temperature should be between 5°C and 25°C.
Operation of the icemaker for extended periods out side of these normal temperature ranges may affect production capacity.

The plug must be accessible after installation.

In general, it is always a good idea to filter the water. A water filter, if it is of the proper type, can remove taste and odors as well as particles. Where water is very hard, softened water may result in white, mushy cubes that stick together. Deionized water is not recommended.



The ice maker must be installed with all electrical, water and drain connections in accordance with state and local codes.

The unit should be located on a firm and level surface. It is important for the ice maker to be leveled in order to work properly. If needed, you can adjust the height of the ice maker by revolving the feet. See the “Leveling the Ice Maker” section.

A standard electrical supply (115VAC, 60Hz), properly grounded in accordance with the National Electrical Code and local codes and ordinances is required.

IMPORTANT: Do not kink or pinch the power supply cord between the ice maker and cabinet.

Electrical Requirements

 **DANGER** 



Electrical Shock Hazard

Plug into a grounding wall outlet.

Never remove the ground prong.

Never use an adapter.

Never use an extension cord.

Failure to follow these instructions can result in death, fire, or electrical shock.

Before you move your ice maker into its final location, it is important to make

sure you have the proper electrical connection.

It is recommended that a separate circuit, serving only your ice maker, be provided. Use receptacles that cannot be turned off by a switch or pull chain.

Recommended grounding method

For your personal safety, this appliance must be grounded. This appliance is equipped with a power supply cord having a grounding plug. To minimize possible shock hazard, the cord must be plugged into a mating grounding-type wall receptacle, grounded in accordance with the National Electrical Code and local codes and ordinances. If a mating wall receptacle is not available, it is the personal responsibility of the customer to have a properly grounding wall receptacle installed by a qualified electrician.

Leveling the Ice Maker

It is important for the ice maker to be leveled in order to work properly. You may need to make several adjustments to level it.

This type of ice maker has a combination of four feet/rollers on the bottom. It can be easily moved anywhere by one person. You will find the feet/rollers combinations very useful for cleaning and sanitizing the surface on which the ice maker is installed because it allows you to move the unit and have easy access to the surface to be cleaned.

IMPORTANT: Once you are ready to install it in a cabinet or directly on the floor, you must adjust the feet to level the ice maker and lock the rollers. If the floor is level, just revolve the two front feet to touch the floor. (See illustration.)

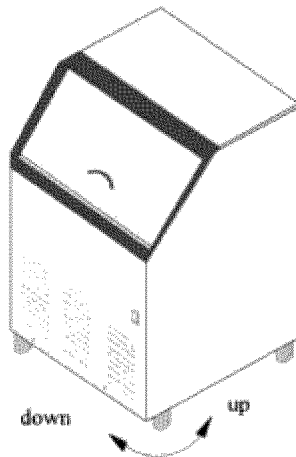

Water Supply and Drain Connections

The water supply and drain should be ready at the point of installation. A wall outlet directly behind the ice maker will make under-counter installation easier.

IMPORTANT:

- 1. All installations must be in accordance with local plumbing code requirements. Professional installation is recommended.*
- 2. Make certain that the pipes are not pinched or kinked or damaged during installation.*
- 3. Check for leaks after connection.*

Connecting the water line:

1. Turn off main water supply.
2. A shut-off valve must be installed to the main water supply. If the water tap has a plain piece of copper tubing, attach a 19mm O.D.
3. Connect water supply pipe to tap and water inlet valve.
4. Turn on main water supply and tap. Check for water supply connections leaks. Tighten any connections .

Connecting the drain line:

A gravity drain system is used in this type ice maker.

NOTE: There is a drain line near the ice maker, it is the best choice to drain water to the drain line through the drain water pipe provided with icemaker.

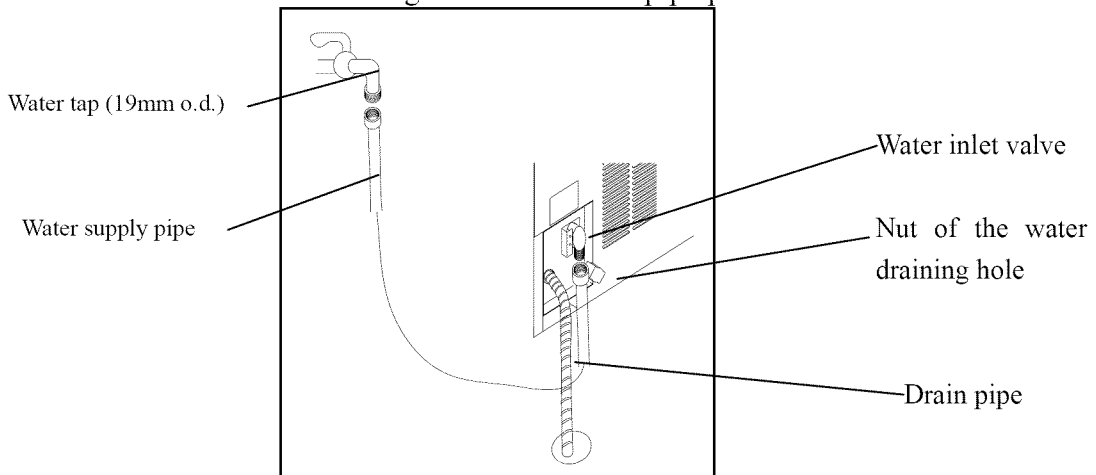

1. Find the floor drain near the ice maker. The distance should be less than 970mm as the length of the long drain water pipe provided with the ice maker is about 970mm.
2. All horizontal runs of drain lines must have a fall of 2cm per meter. An air gap will likely be required between the ice maker drain tube and the drain/waste

receptacle. A stand pipe with a trap below it would be acceptable for the drain/waste receptacle. A floor drain is also acceptable.

3. Pour 4 liter of water into the ice storage bin to check for leaks at all drain connections and at the nut of the drain water hole. Tighten any connections or nuts that leak.

IMPORTANT: Poor drainage will cause a high rate of ice melting in the ice storage bin.

Installation Types

This ice maker has been designed for Mobile (free-standing), Enclosed, or Built-in (sealed) installation.

Mobile installation:

A mobile installation will allow you to install the icemaker free-standing in any place you desire provided you have access to a water supply and drainage facilities. You must follow the stated instructions for

- a- Electrical requirements
- b- Water supply and drain connections
- c- Leveling the icemaker.

Enclosed installation:

An enclosed installation will allow you to install the ice maker under a cabinet, or in a kitchen cabinet provided the required clearance space around the ice maker is respected. This installation has the same requirements as a mobile installation.

The unit should be placed in the cabinet by sliding it in the cabinet's opening and leveled properly.

IMPORTANT: For the Mobile and Enclosed installations you must use flexible water and drain connections to the water supply and drain. This will allow the moving of the ice maker for cleaning. Use the water hose and drain hose supplied with the unit for these connections.

Built-in installation:

When the ice maker is to be built-in, the following additional items must be observed.

1. Place ice maker in front of installation location. Remove the feet and place the

unit flat on the floor or on a platform depending on your installation requirements.

2. The water supply pipe and drainpipe must be plumbed before connecting to the ice maker.
3. Turn on main water supply and tap. Check for water supply connection leaks. Tighten any connections (including connections at the valve) or nuts that leak.
4. Pour 4 liter of water into the ice storage bin to check leaks at all drain connections and the nut of the drain water hole. Tighten any connections or nuts that leak.
5. Push the ice maker into position.
6. Seal all around the cabinet to the floor with an approved caulking compound.

OPERATION

Final Check List before Operation

1. Have all packing materials and tape been removed from the interior and exterior of the ice maker?
2. Did you clean the ice storage bin?
3. Have the installation instructions been followed, including connecting the machine to water, drain and electricity?
4. Has the machine been leveled? Feet locked?
5. Is the ice maker in a site where the ambient temperature is between 13°C and 32°C and the water temperature within 5°C and 25°C all year round?
6. Has the water supply pressure been checked to ensure a minimum of 0.1Mpa and a maximum of 0.5Mpa?
7. Is there at least a clearance of 150mm at rear, and 40mm at sides and top for proper air circulation?
8. Has the power supply voltage been checked or tested against the data label rating? And has proper grounding been installed in the ice maker?
9. Is the ice maker plugged in?
10. Did you turn on the main water supply and the tap?
11. Did you check leaks to all water supplies and drainpipe connections?

Operating Method

1. Switch on the Power switch on the front panel. The light will be on. The ice maker will start working automatically and feeding water.
2. After the first feeding of the water, the machine will automatically go to the ice making stage, and the sound of water spraying will be heard.
3. Ice will be harvested to the ice storage bin. When the storage bin is filled with ice cubes, the ice maker will automatically stop working. The machine will restart making ice once the storage bin is less than full.
4. Excess water will flow through the drain outlet at the back of the machine and empty into the floor drain.

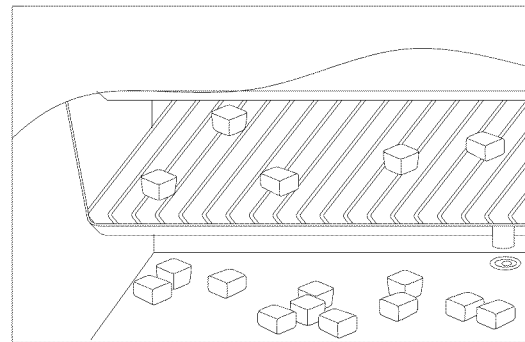
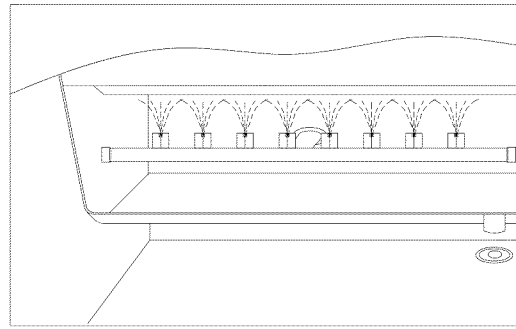

IMPORTANT:

- *Although the unit has been tested at factory, due to long-term transit and storage, the first batch of cubes must be discarded.*
- *Never turn the water supply tap off when the icemaker is working.*

How the Machine Makes Ice

There are two distinct cycles: freezing and harvest.

During the freezing cycle, water is sprayed against the evaporator surface.

In the harvest cycle, the ice is released and water enters the machine. A complete cycle takes about 20 minutes.

Freeze: During the freezing cycle the compressor is pumping refrigerant, the fan motor is blowing air, and the water pump is circulating water. When the evaporator surface gets to the setting temperature, the ice maker stops the freezing cycle and begins the harvest.

Harvest: During the harvest cycle the compressor is still operating, but the water pump has stopped. Two other components have been energized: the hot gas valve

and water inlet valve. These two valves open and warm up the freezing surface, so the cubes to fall into the bin. The freeze cycle will restart.

How the machine uses water

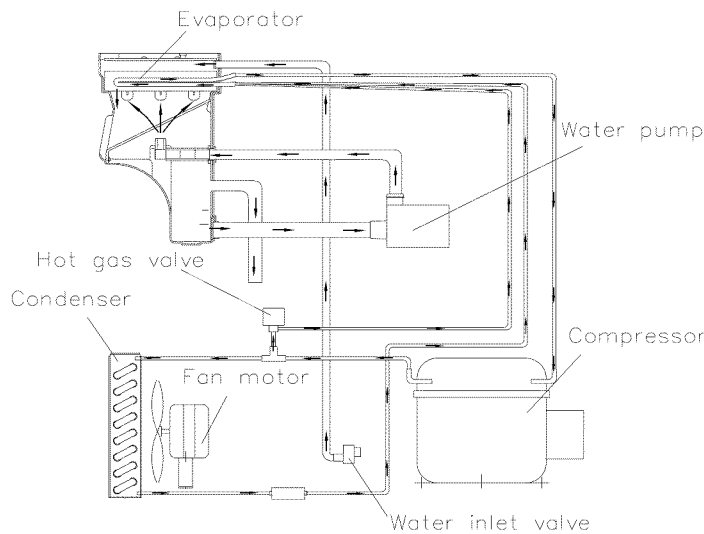

The ice maker begins with a fixed charge of water that is contained in the water bin. As the water is sprayed against the freezing evaporator surface, the portion of water that does not contain mineral impurities will freeze and stick to the ice cube molds. The water containing

impurities falls back into the water bin. Gradually, during the freezing portion of the ice-making cycle, the water in the water bin will become highly concentrated with mineral impurities.

During the harvest cycle, the fresh water flows into the machine to dilute the bin water, and to rinse the concentrated minerals down the drain.

Normal Sounds

Your new ice maker may make sounds that are not familiar to you. Most of the new sounds are normal. Hard surfaces like the floor, walls and cabinets can make the sounds seem louder than they actually are. The following describes the kinds of sounds that might be new to you and what may be making them.

- You will hear a swooshing sound when the water valve opens to fill the water bin for each cycle.
- Rattling noises may come from the flow of the refrigerant or the water line. Items stored on top of the ice maker can also make noises.
- The high-efficiency compressor may make a pulsating or high-pitched sound.
- Water running from the water bin to the evaporator plate may make a splashing sound.

- Water running from the evaporator to the water bin may make a splashing sound.
- As each cycle ends, you may hear a gurgling sound due to the refrigerant flowing in your icemaker.
- You may hear air being forced over the condenser by the condenser fan. During the harvest cycle, you may hear the sound of ice cubes falling into the ice storage bin.
- When you first start the ice maker, you may hear water running continuously. The ice maker is programmed to run a rinse cycle before it begins to make ice.

Preparing the Ice Maker for Long Storage

If the ice maker will not be used for a long time, or is to be moved to another place, it will be necessary to drain the water of system.

1. Shut off the water supply at the main water source.
2. Disconnect the water supply line from the water inlet valve.
3. Disconnect the drain pipe to the drain line or floor drain.
4. Allow the ice maker to run for an hour or more until all remaining ice cubes have been ejected from the ice maker assembly.
5. Shut off the electric supply at main electrical power source.
6. Screw off the nut of the water drain hole at the back of the machine, drain out water residue completely (do not loosen or screw off the nut at other times), then tighten the nut after finishing.
7. Drop the door open to allow for circulation and prevent mold and mildew.
8. Leave water supply line and power cord disconnected until ready to reuse.

CLEANING AND MAINTENANCE

CAUTION

If the ice maker is left unused for a long time, before the next use it must be thoroughly cleaned. Follow carefully any instructions provided for cleaning or use of sanitizing solution. Do not leave any solution inside the ice maker after cleaning.

Periodic cleaning and proper maintenance will ensure efficiency, top performance, and long life. The maintenance intervals listed are based on normal conditions. You may want to shorten the intervals if you have pets, or the unit is used outdoors, or there are other special considerations.

What shouldn't be done

Never keep anything in the ice storage bin that is not ice: objects like wine and beer bottles are not only unsanitary, but the labels may slip off and plug up the drain.

What should be kept clean

There are 4 things to keep clean:

1. The exterior
2. The condenser
3. The interior
4. The ice-making system

WARNING

Before proceeding with cleaning and maintenance operations, make sure the power line of the unit is disconnected and the water line is shut off (EXCEPTION: Ice maker system's cleaning).

Exterior Cleaning

The door and cabinet may be cleaned with a mild detergent and warm water solution such as 28g of dishwashing liquid mixed with 7.5L of warm water. Do not use solvent-based or abrasive cleaners. Use a soft sponge and rinse with clean water. Wipe with a soft clean towel to prevent water spotting.

Stainless steel models can discolor when exposed to chlorine gas and should be cleaned. Clean stainless steel models with a mild detergent and warm water solution and a damp cloth. Never use abrasive cleaning agents.

NOTICE: *Stainless steel models exposed to chlorine gas and moisture, such as in areas with spas or swimming pools, may have some discoloration of stainless steel. Discoloration from chlorine gas is normal.*

Condenser Cleaning

A dirty or clogged condenser prevents proper airflow, reduces ice making capacity, and causes higher than recommended operating temperatures that may lead to component failure. Have the condenser cleaned at least once every three months.

1. Unplug the ice maker or disconnect power.
2. Remove the 2 screws in the front cover. Pull upward to remove the front cover.
3. Locate the condenser surface.

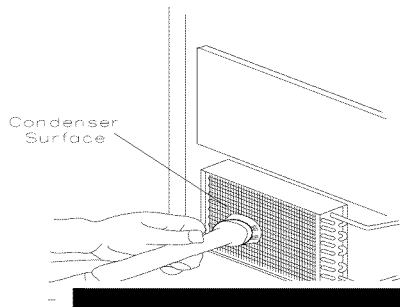

4. Remove dirt and lint from the condenser fins and the unit compartment with a brush attachment on a vacuum cleaner.
5. Reassemble the front cover.
6. Plug in the icemaker or reconnect power.



WARNING

DO NOT touch the condenser fins. The condenser fins are sharp and can be easily damaged.

Interior Cleaning

The ice storage bin should be sanitized occasionally. Clean the bin before the ice maker is used for the first time and reused after stopping for an extended period of time. It is usually convenient to sanitize the bin after the ice making system has been cleaned, and the storage bin is empty.

1. Disconnect power to the unit.
2. Open the door and with a clean cloth, wipe down the interior with a sanitizing solution made of 28g of household bleach or chlorine and 7.5L of hot water (35°C to 46°C).
3. Rinse thoroughly with clear water. The waste water will be drained off through the drainpipe.
4. Reconnect power to the unit.

The ice scoop should be washed regularly. Wash it just like any other food container.



WARNING

DO NOT use solvent cleaning agents or abrasives on the interior. These cleaners may transmit taste to the ice cubes, or damage or discolor the interior.

IMPORTANT NOTE: *The sprinkler should only be cleaned when you find that some of the ice cubes are improperly shaped during ice making. Cleaning the ice making system should follow cleaning of the sprinkler.*

1. Connect power to the unit and open the door.

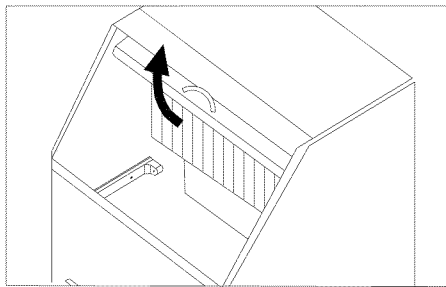

2. Take out the row of flake covers.

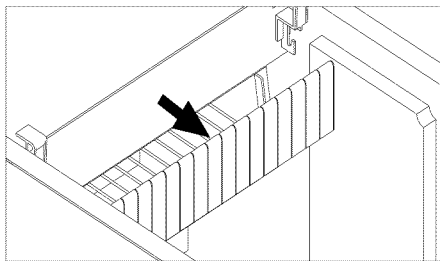

3. Find the sprinkler and the slideway.

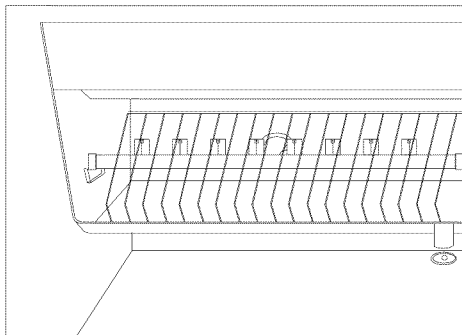

4. Open the power switch, the ice maker works. Water sprays from the small nozzles, find which water sector is not sprayed well. If the reason is the slideway break the water sector, just adjust the position of slideway to have all the water sectors free forward to the ice mold. If the water sectors are free, but some sector is not sprayed well, using a new teeth-brush clean the gap of the nozzle several times. The water sector will be OK.

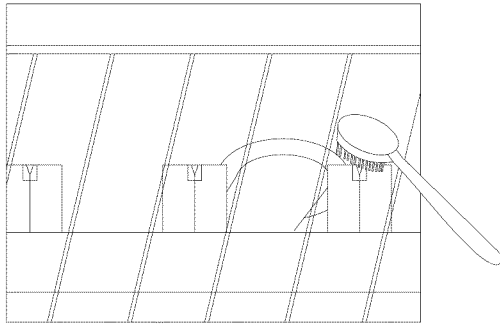

5. This kind of cleaning method can't change the cubes quality (only the ice cube's shape), you can do another cleaning method. Remove the slideway from the water bin.

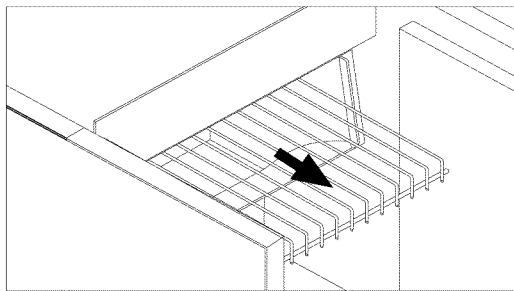

6. Find the sprinkler arm and raise it. Disconnect it from any water tube.

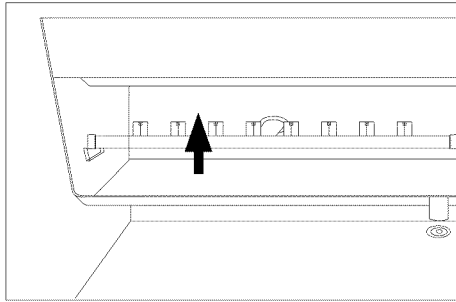

7. A de-scaling solution can be prepared in a plastic basin with Nu-Calgon Nickel-Safe Ice Machine Cleaner. Mix 4 ounces of the ice machine cleaner per gallon of warm water.
8. Remove the sprinkler arm from the interior. Thoroughly clean the sprinkler arm by soaking it in the basin filled with the de-scaling solution until it is free of any deposit; use a soft brush to remove any thick or stubborn residue and to help the dissolving action. Rinse under a stream of tap water.
9. Wipe down the interior of the water bin with the de-scaling solution and warm water. Rinse thoroughly with clear water.
10. Reassembly properly the sprinkler arm, slideway and the flake covers.
11. After the Icemaker System Cleaning procedure below.

Ice Making System Cleaning

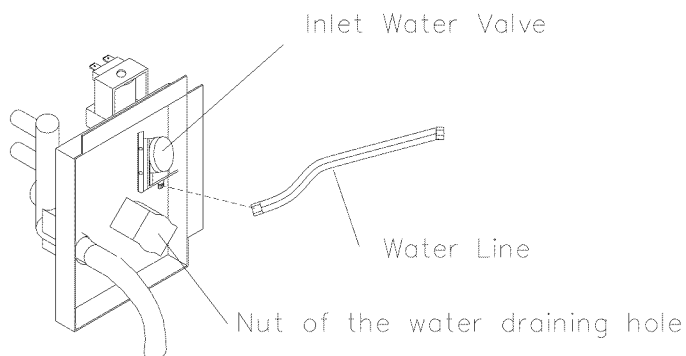

Minerals that are removed from water during the freezing cycle will eventually form a hard scaly deposit in the water system. Cleaning the system regularly helps remove the mineral scale buildup. How often you need to clean the system depends upon how hard your water is. With hard water of 4 to 5 grains/liter, you may need to clean the system as often as every 6 months.

1. Turn off power to the ice maker. Keep the ice maker connecte to the water supply and drainpipe.
2. Open the door and scoop out all of the ice cubes. Either discard them or

save them in an ice chest or cooler.

Remove the screws in the front cover, push forward to remove the front cover. **Notice:** *Don't overexert, or the leads connected with the power switch can be torn down.* Put the front cover against the right side cover.

3. Locate the control box.

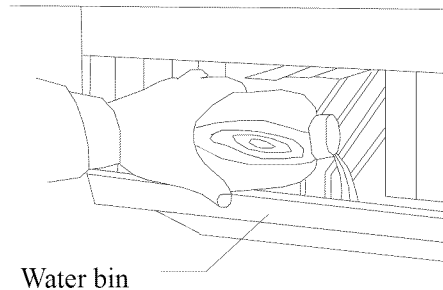

4. Turn on the power to the ice maker. Pour 230g of Nickel-Safe Ice Maker Cleaning Solution into the water bin. Add 230g of tap water. After about 5 minutes, press down the "clean" button on the Control Box. (See figure below and following

section.) The machine will run the Automatic Clean Mode.

5. Allow 30 minutes for proper cleaning. After cleaning, shut off the power switch, and unscrew the nut of the water-draining hole. Drain off the waste water to some container, and then screw the nut on tightly when the waste water is fully drained off.
6. Repeat steps 4 and 5 (without Ice Maker Cleaning Solution) to rinse the ice making system 3 times.

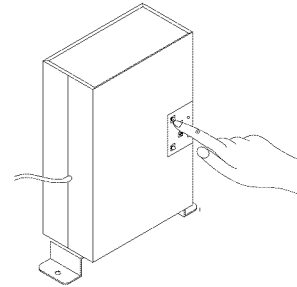

Note: The use of the Ice Maker Cleaner Solution in the water bin during the rinse is not needed.

WARNING

The ice machine cleaner contains acids.
DO NOT use or mix with any other solvent-based cleaner products.
Use rubber gloves to protect hands. Carefully read the material safety instructions on the container of the ice machine cleaner.
DISCARD the first batch of ice produced after cleaning.

7. Prepare a sanitizing solution made of 28g of household bleach and 7.5L of hot water (35°C to 46°C). Remove the flake covers and slidaway from the water bin and wipe the entire bin inside and out, covering the entire surface of the walls.

8. Fill a spray bottle with the sanitizing solution and spray all corners and edges making sure to cover all surfaces with the solution. Soak the flake cover and slideway in the solution and put back in place after drying.
9. Allow the solution to be in contact for at least 3 minutes, then dry.
10. Repeat step 6 to rinse the ice making system one more time.
11. Reassemble the front cover.
12. Turn on the power again. The machine will return to the regular ice making mode. Discard the first batch of ice.

Control Box (See diagram on page 30.)

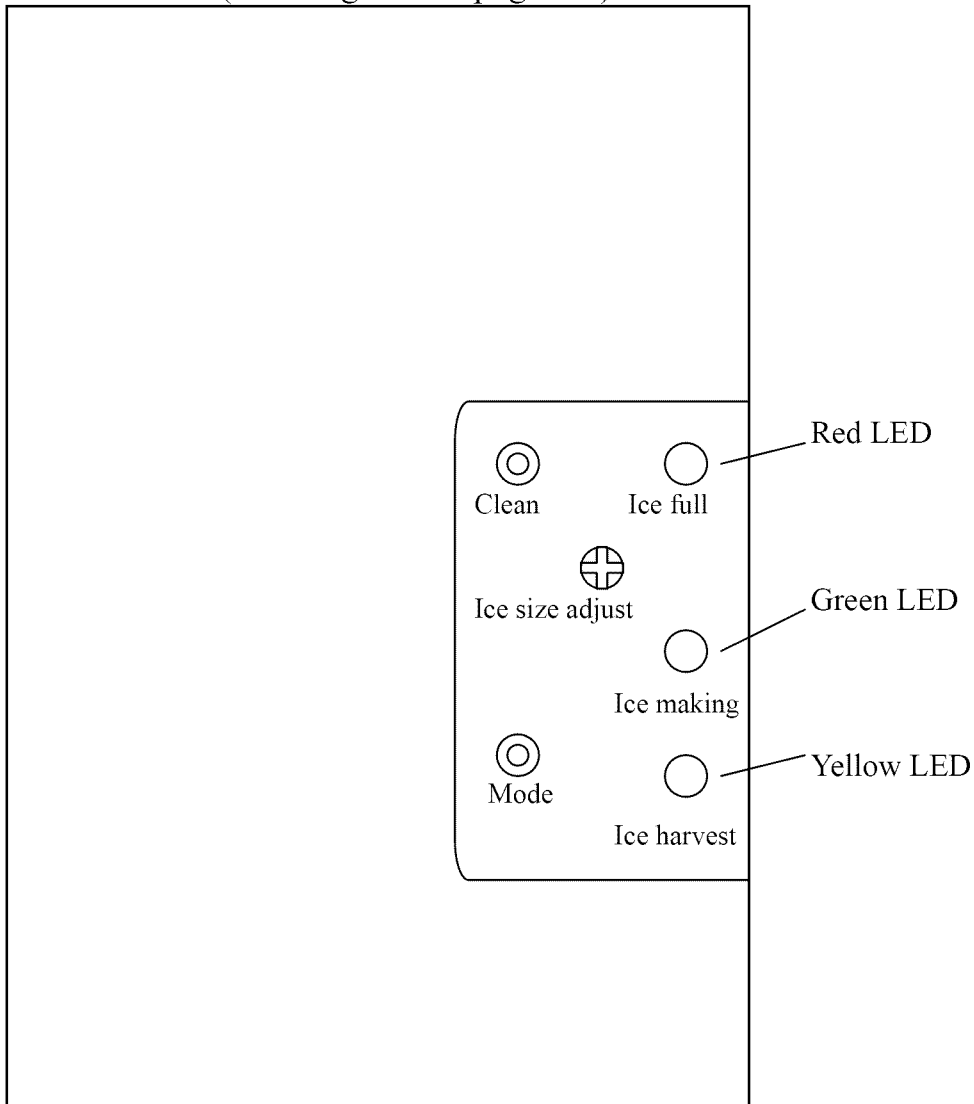

Control box (behind Front Cover)

Descriptions of LEDs and buttons:

1. **RED LED:** Ice full indicator light.
When this LED is lit, the ice storage bin is full of ice or there is something between the two arms of the ice-full sensor in the ice storage bin. The unit will stop working. When ice cubes are taken out of the ice storage bin, clearing the sensor, the red LED will keep flashing for 3 minutes. Then the unit will restart and return to the ice making mode.
2. **GREEN LED:** Ice making indicator light.
When this LED is lit, the unit is working in the ice making mode controlled by a temperature probe on the evaporator. When the green LED is flashing, the unit is working in the ice making mode controlled by a fixed timer.
3. **YELLOW LED:** Ice harvest indicator light.
When this LED is lit, the unit is working in the ice harvest mode controlled by a temperature probe on the evaporator. When the yellow LED is flashing, the unit is working in the ice harvest mode controlled by a fixed timer.
4. **CLEAN button:** When this button is pressed, the unit enters the cleaning mode. The green and yellow LEDs flash together. To stop the cleaning mode, just press the button again.
5. **MODE button:** Mainly for service. When this button is pressed, it can change from ice making mode to ice harvest mode, or from ice harvest mode to ice making mode. You can judge the mode from the status of the green and yellow LEDs.
6. **ICE SIZE ADJUST:** Turn the screw clockwise, and the size of individual ice cubes will be larger in the next cycle; the cycle time will be longer. Turn the knob counter-clockwise, and the ice size will be smaller in the next cycle.
NOTE: It is not a good idea to adjust the ice size often or for no good reason, because the controller may be damaged.
7. If the red, green and yellow LEDs are flashing together, the machine is not working. The major fuse of the control box has failed. Call for service.

NOTE: Avoid letting water contact the control box.

Major Functions

1. Completely automatic operating procedure.
2. When the ice storage bin is full of ice cubes, the machine stops working automatically and starts again after the cubes are removed.
3. The different colors of the LED display indicate various work modes.
4. Indication of failure of major control box fuse.
5. The fan motor responds to the ambient temperature. If it is cold, the motor will stop working to keep the cooling system in good working condition.
6. Ice cube size is adjustable.
7. A sensitive probe and accurate timer enhance the performance of the ice maker.
8. Manual clean mode to start or stop the ice making system cleaning.
9. Built-in compressor protection system.

TROUBLESHOOTING

Before Calling for Service

If the unit appears to be malfunctioning, read through the OPERATION section of this manual first. If the problem persists, check the TROUBLESHOOTING GUIDE on the following pages. The problem could be something very simple which can be solved without a service call.

Troubleshooting Guide

Problem	Possible Cause	Probable Correction
The machine doesn't operate	The ice maker is unplugged.	Plug the ice maker in.
	The fuse is blown.	Replace fuse--if it happens again, call for service to check for a short circuit in the ice maker.
	The ice maker power switch is OFF.	Turn the ice maker power switch ON
	The voltage of the power supply is low.	Add manostat.
	Ice cube full sensor damage	Replace the Ice cube full sensor
	The ice storage bin is full of ice.	Remove some ice; make sure the ice-full sensor is free of ice.
The water doesn't feed in after the ice maker starts.	The water supply tap is turned off.	Turn on the water supply tap.
	Water supply pressure is lower.	Adjust the water supply pressure within the range of stated range.
	Water inlet valve damage	Replace the water inlet valve.
	The water supply pipe is not properly connected.	Reconnect the water supply pipe.
Machine makes ice, but bin does not fill up with ice	The bin should fill up and the machine shut off in 9-14 hours. If not, the condenser may be dirty.	Clean the condenser.
	The bin drain may be partially restricted.	Clean out the drain, check the installation.
	The airflow to the ice maker may be obstructed.	Check the installation.
	Hot gas valve performance poor, lead to few ice is produced.	Replace the hot gas valve
	The sprinkler partially clogged, lead to few ice is produced.	Clean the sprinkler, see the user's manual "interior cleaning"
	Spraying of the small nozzle blocked by the ice slideway	Adjust the location of the ice slideway.
	The water quality is too poor. The water line blocks,lead to sprinkler pressure of spray isn't enough.	Using a filter apparatus installed in front of the water inlet valve.
	The ambient temperature and water temperature are high, or machine is near some heat source.	Check the installation.

Water is leaking from the unit.	A few water drops fall to the floor when you open the door to take out ice from ice storage bin.	Normal condensation on the door or some water together with ice. Take care when you take out ice.
	Water supply connection leaking.	Tighten fitting. See “Connecting the Water Line”.
	Nut of the water drain hole leaking.	Tighten the nut.
	Drainpipe connection leaking.	Tighten fitting. See “Connecting the Drain”.
The body of the ice maker is electrified.	The grounding line isn't in the socket.	Use the socket meeting the required electrical standard.
	The lines are creepage.	Adjust, reconnect /replace lines
Scales occur frequently inside the machine.	The hardness of the water is too high.	Use a water-softening device installed in front of the water inlet valve.
	The sprinkler is blocked. partially	Clean it; see "Interior Cleaning".
	The sprinkler pressure of spray isn't enough.	Check.the water quality The water line may be blocked
Noise during operation	The feet are not leveled and locked	Level and lock the feet. See “Leveling the Ice Maker”.
	Certain sounds are normal.	See “Normal Sounds”.
The downcomer doesn't leak.	The water line blocks	Clean it, see user and care manual "ice making system cleaning"
Harvesting ice is difficult	The water supply tap is turn off.	Turn on the water supply tap.
	The ambient temperature and water temperature is too low	Adjust the temperature.
The ice maker stops suddenly while making ice.	The electricity is off.	Reconnect the power supply line.
	The room temperature is out of the stated range.	Cut off the electricity; let the ice maker stop working till the temperature returns within the stated range.
	The fuse is brown.	Replace fuse.
	The voltage of the power supply is low.	Add manostat.
	The ventilation louvers are covered.	Remove the obstruction.
Cubes are too big.	The ambient temperature and water temperature is too low.	Adjust the temperature.