

This Owner's Manual is provided and hosted by [Appliance Factory Parts](#).

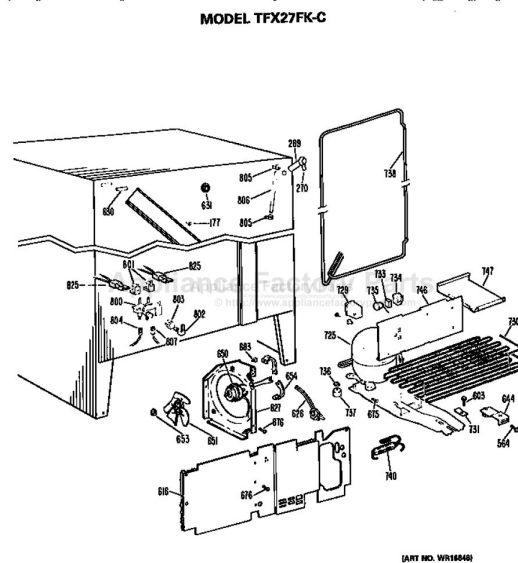

GE TFX27FKC Owner's Manual

[Shop genuine replacement parts for GE TFX27FKC](#)



[Find Your GE Refrigerator Parts - Select From 27446 Models](#)

----- Manual continues below part list -----

Available Replacement Parts for GE TFX27FKC

WR57X10051	WATER VALVE
WR2X4550	DRIVE CUP



GE Appliances

Side by side
Refrigerators

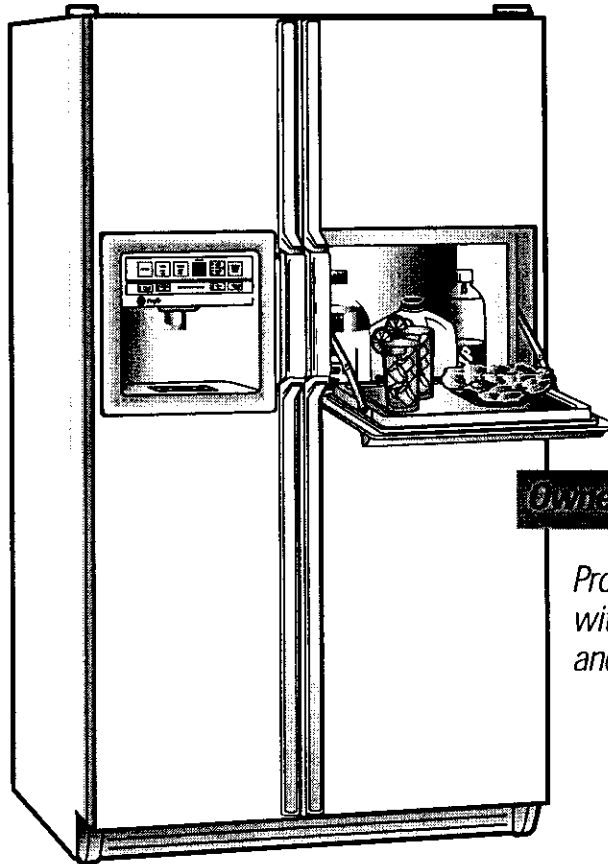

Owner's Manual

*Profile Models 24 & 27
with Refreshment Center
and Electronic Dispenser*



Congratulations! You Are Now Part of the GE Family.

Welcome to the GE family. We're proud of our quality products and we are committed to providing dependable service. You'll see it in this easy-to-use Owner's Manual and you'll hear it in the friendly voices of our customer service department.

Best of all, you'll experience these values each time you use your refrigerator. That's important, because your new refrigerator will be part of your family for many years. And we hope you will be part of ours for a long time to come.

We thank you for buying GE. We appreciate your purchase, and hope you will continue to rely on us whenever you need quality appliances for your home.



Important!

Staple sales slip or cancelled check here.

Proof of the original purchase date is needed to obtain service under the warranty.



Write the model and serial numbers here.

#

#

You can find them on a label on the wall beside the top drawer or at the bottom, just inside the fresh food compartment door.

GE & You, A Service Partnership.

Ask any GE appliance owner and they will tell you we stand behind our products with unmatched quality service. However, did you know that most questions result from simple problems that you can easily fix yourself in just a few minutes? This Owner's Manual can tell you how.



Read this manual

Inside you will find many helpful hints on how to use and maintain your refrigerator properly. Just a little preventive care on your part can save you a great deal of time and money over the life of your refrigerator.



Review the section on Troubleshooting Tips

You'll find many answers to common problems here. If you review our chart of Troubleshooting Tips first, you may not need to call for service at all.



If You Need Service

If you do need service, you can relax knowing help is only a phone call away. A list of toll-free customer service numbers is included in the back section. Or, **in the U.S.**, you can always call the GE Answer Center® at 800.626.2000, 24 hours a day, 7 days a week. **In Canada**, call 800-361-3400.



Languages

English	4
Français	43
Español	87

Safety Information

Safety Precautions	4
How to Connect Electricity	6
Use of Adapter Plugs	6, 7
Use of Extension Cords	7

Operating Instructions

Controls	8-14
Features	15-18
Refreshment Center	19
Icemaker	20
Dispenser	21, 22
Care and Cleaning	23-27

Installation Instructions

Preparing to Install the Refrigerator	28, 29
Water Line Installation	30-34

Troubleshooting Tips

Normal Operating Sounds	35
Before You Call For Service	36-40

Customer Service

Warranty for Canadian Customers	41
Warranty for U.S. Customers	42
Service Telephone Numbers	Back Cover

Safety Information

Operating Instructions

Troubleshooting Tips

Customer Service

IMPORTANT SAFETY INFORMATION. READ ALL INSTRUCTIONS BEFORE USING.

⚠ WARNING!

Use this appliance only for its intended purpose as described in this Owner's Manual.

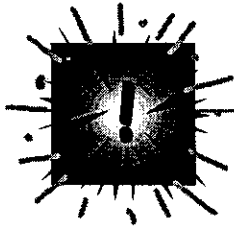

SAFETY PRECAUTIONS

When using electrical appliances, basic safety precautions should be followed, including the following:

- This refrigerator must be properly installed and located in accordance with the Installation Instructions before it is used.
- Do not allow children to climb, stand or hang on the shelves in the refrigerator. They could damage the refrigerator and seriously injure themselves.
- Do not allow anyone to climb, sit, stand, or hang on the Refreshment Center door. They could damage the refrigerator and maybe even tip it over, causing severe personal injury.
- Do not touch the cold surfaces in the freezer compartment, particularly when hands are damp or wet. Skin may stick to these extremely cold surfaces.
- Do not store or use gasoline or other flammable vapors and liquids in the vicinity of this or any other appliance.
- In refrigerators with automatic icemakers, avoid contact with the moving parts of the ejector mechanism, or with the heating element that releases the cubes. Do not place fingers or hands on the automatic icemaking mechanism while the refrigerator is plugged in.
- Keep fingers out of the "pinch point" areas; clearances between the doors and between the doors and cabinet are necessarily small. Be careful closing doors when children are in the area.
- Unplug the refrigerator before cleaning and making repairs.

NOTE: We strongly recommend that any servicing be performed by a qualified individual.

- Turning the control to the **OFF** position does not remove power to the light circuit.
- Do not refreeze frozen foods which have thawed completely.

IMPORTANT: *PROPER DISPOSAL OF THE REFRIGERATOR*

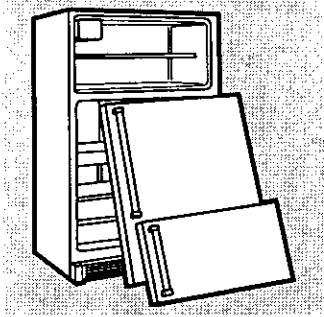

Child entrapment and suffocation are not problems of the past. Junked or abandoned refrigerators are still dangerous...even if they will sit for "just a few days." If you are getting rid of your old refrigerator, please follow the instructions below to help prevent accidents.

Before You Throw Away Your Old Refrigerator or Freezer:

- Take off the doors.
- Leave the shelves in place so that children may not easily climb inside.

CFC Disposal

Your old refrigerator has a cooling system that used CFCs (chlorofluorocarbons). CFCs are believed to harm stratospheric ozone.

If you are throwing away your old refrigerator, make sure the CFC refrigerant is removed for proper disposal by a qualified servicer. If you intentionally release this CFC refrigerant you can be subject to fines and imprisonment under provisions of the Federal Clean Air Act.

IMPORTANT SAFETY INFORMATION. READ ALL INSTRUCTIONS BEFORE USING.

⚠ WARNING!



HOW TO CONNECT ELECTRICITY

Do not, under any circumstances, cut or remove the third (ground) prong from the power cord. For personal safety, this appliance must be properly grounded.

The power cord of this appliance is equipped with a 3-prong (grounding) plug which mates with a standard 3-prong (grounding) wall outlet to minimize the possibility of electric shock hazard from this appliance.

Have the wall outlet and circuit checked by a qualified electrician to make sure the outlet is properly grounded.

Where a standard 2-prong wall outlet is encountered, it is your personal responsibility and obligation to have it replaced with a properly grounded 3-prong wall outlet.

The refrigerator should always be plugged into its own individual electrical outlet which has a voltage rating that matches the rating plate.

This provides the best performance and also prevents overloading house wiring circuits which could cause a fire hazard from overheated wires.

Never unplug your refrigerator by pulling on the power cord. Always grip plug firmly and pull straight out from the outlet.

Repair or replace immediately all power cords that have become frayed or otherwise damaged. Do not use a cord that shows cracks or abrasion damage along its length or at either end.

When moving the refrigerator away from the wall, be careful not to roll over or damage the power cord.

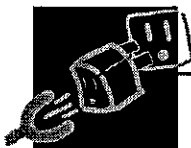

USE OF ADAPTER PLUGS

Because of potential safety hazards under certain conditions, we strongly recommend against the use of an adapter plug.

However, if you must use an adapter, where local codes permit, a **temporary connection** may be made to a properly grounded 2-prong wall outlet by use of a UL-listed adapter available at most local hardware stores.

The larger slot in the adapter must be aligned with the larger slot in the wall outlet to provide proper polarity in the connection of the power cord.

When disconnecting the power cord from the adapter, always hold the adapter in place with one hand while pulling the power cord plug with the other hand. If this is not done, the adapter ground terminal is very likely to break with repeated use.

If the adapter ground terminal breaks, **DO NOT USE** the refrigerator until a proper ground has been established.

Attaching the adapter ground terminal to a wall outlet cover screw does not ground the appliance unless the cover screw is metal, and not insulated, and the wall outlet is grounded through the house wiring. You should have the circuit checked by a qualified electrician to make sure the outlet is properly grounded.



USE OF EXTENSION CORDS

Because of potential safety hazards under certain conditions, we strongly recommend against the use of an extension cord.

However, if you must use an extension cord, it is absolutely necessary that it be a UL-listed, 3-wire grounding type appliance extension cord having a grounding type plug and outlet and that the electrical rating of the cord be 15 amperes (minimum) and 120 volts.



REMEMBER...

Your continued health and safety are important to us.

Please read and follow this Safety Information carefully.

We want you to remain a happy and healthy part of our GE family.

SAVE THESE INSTRUCTIONS

About the controls on the refrigerator.

The temperature controls on your refrigerator have letters and numbers. Initially set the fresh food control at **5** and the freezer control at **C**.

If you want colder or warmer temperatures, adjust the fresh food temperature first. When satisfied with that setting, adjust the freezer temperature.

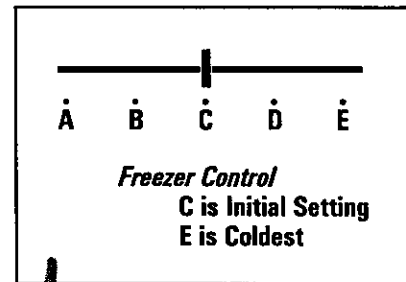
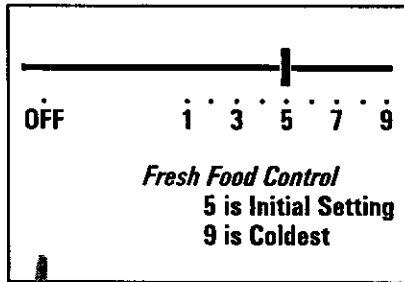

Temperature Controls



Fresh Food Control

The fresh food control maintains the temperatures throughout the fresh food compartment.

Moving the fresh food control to **OFF** stops cooling in both areas—fresh food and freezer—but does not shut off power to the refrigerator.



Freezer Control

The freezer control maintains the temperatures throughout the freezer compartment.

The Electronic Monitor and Diagnostic System monitors the operation of your refrigerator and controls dispenser functions.

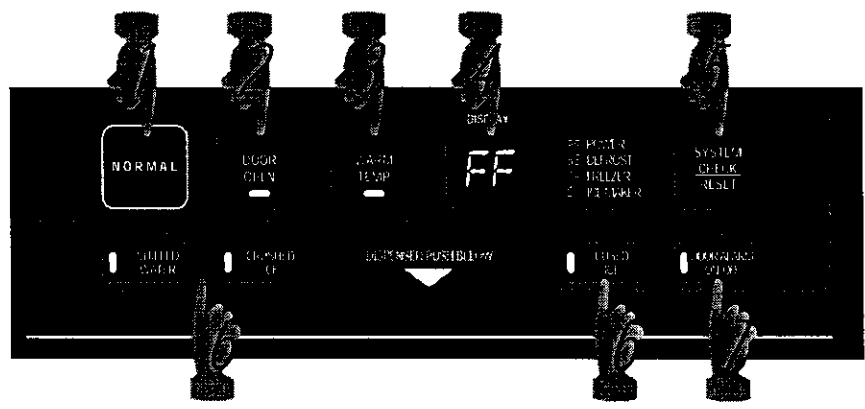

Electronic Monitor and Diagnostic System





- 

1 Lighted word **NORMAL** indicates that no failure has been detected by the diagnostic system.
- 

2 **DOOR OPEN.** Red signal light flashes to tell you when either door is open.
- 

3 **WARM TEMP.** Red signal light tells you when freezer food-keeping temperature is above normal.
- 

4 Flashing diagnostic codes in the display warn you when:

 -  frozen foods should be checked.
 -  power has been interrupted.
 -  icemaker may not be operating properly.
 -  defrost system has failed.

What these codes mean—and what to do when they appear—is explained more thoroughly on the following pages.
- 

5 **SYSTEM CHECK-RESET** pad puts a review of the electronic diagnosis of four coded functions at your fingertip and also allows you to erase codes from display.
- 

6 Electronic control allows you to select **CUBED ICE**, **CRUSHED ICE** or **CHILLED WATER** and signal light confirms your choice.
- 

7 Signal light tells you that the **DOOR ALARM** beeper has been set to sound after either door has been open 30 seconds.

About the controls on the refrigerator.

When Your Refrigerator is First Plugged In

All panel lights come on for five seconds, a beep sounds, and lights go off except as follows:

- **PF** flashes in the display. Touch **SYSTEM CHECK-RESET** pad to erase it.
- Word **NORMAL** glows.
- Red **WARM TEMP** light glows if freezer compartment temperature is higher than normal. It goes off when proper food-keeping temperature is reached.
- Door alarm beeper is activated and light on **DOOR ALARM** pad glows.
- **CRUSHED ICE** selection light glows.
- Red **DOOR OPEN** light flashes if either door is open, goes out when doors are shut.
- Night light in ice and water dispenser is off.



How to Set the Door Alarm

You don't have to set the visual alarm. As long as either door is open, the red **DOOR OPEN** signal light flashes.

If the signal light on the **DOOR ALARM** pad is glowing, the beeper alarm is set. If it's not, touch the pad to turn it on.

If either door is open for more than 30 seconds, a recurring beep sounds.

The light goes out and the beeping stops when you close the door.

There are times when you'll want the door alarm beeper turned off. When you're rearranging a lot of food, for example, just touch the pad. The light will go out and the beeping will stop.

Deactivating the door alarm beeper does not turn the red **DOOR OPEN** light off—it keeps flashing until the door is closed.

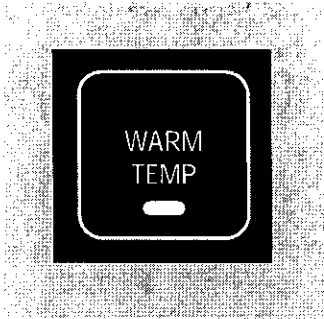

Why the Red WARM TEMP Light Glows

At first, it's probably because your newly-installed refrigerator hasn't completely cooled down yet. Wait a few hours for it to cool, and then the light will go out.

From then on, the red light will glow whenever temperatures inside get too high for proper food storage. If this happens, open the doors only when absolutely necessary, and close them as quickly as possible.

As soon as inside temperatures return to normal, the light goes out.

If the **WARM TEMP** light reappears and stays on for longer than 4 hours, call for service.

About the controls on the refrigerator.

How the Electronic Monitor and Diagnostic System Works

The electronic monitor and diagnostic system alerts you when something starts to go wrong.

If a diagnostic code appears on the display, something needs special attention. To get your attention, the display code flashes until you erase it. The first 6 flashes are accompanied by beeps.

If more than one coded function requires attention at the same time, the one with the highest priority will be displayed first.

Pressing the **SYSTEM CHECK-RESET** pad will evaluate all other coded functions. If the **NORMAL** display is lit during the displaying of a code, that function is operating properly.

Pressing the **SYSTEM CHECK-RESET** pad will erase two codes immediately—**PF** and **CI**. The **dE** and **FF** codes can only be erased by touching the **SYSTEM CHECK-RESET** pad after the condition that caused the code to flash has been corrected.

The word **NORMAL** is lighted except when a failure has been detected.

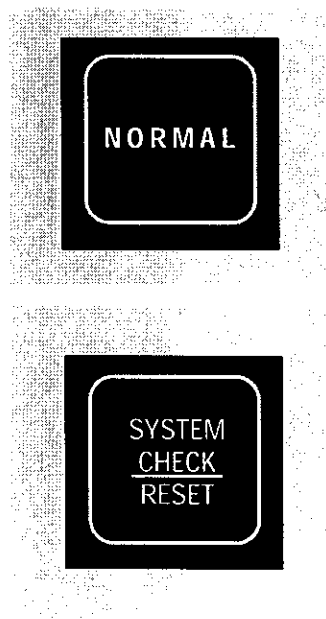

The **SYSTEM CHECK-RESET** pad has two functions:

- 1 You can touch the **SYSTEM CHECK-RESET** pad and get a review of the electronic diagnostic codes in order of their priority.
- 2 You can touch the **SYSTEM CHECK-RESET** pad to erase two flashing codes immediately and two codes after the condition that caused them to flash has been corrected.

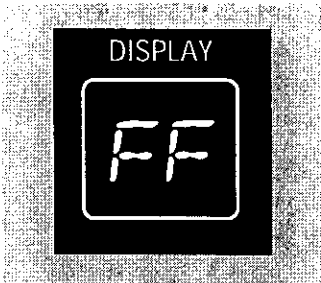

This flashing code tells you to check your frozen food. Has any of it started to thaw? A package may be holding the freezer compartment door open. Don't open the door more often than absolutely necessary while this code is displayed. Touching the **SYSTEM CHECK-RESET** pad after the freezer compartment temperature has returned to normal will erase the code.

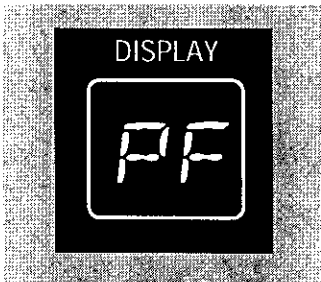

This flashing code tells you the power to the refrigerator has been interrupted for more than two seconds. Check the condition of food in both the fresh food and freezer compartments. Touch the **SYSTEM CHECK-RESET** pad to erase the code.

There is no fault with the refrigerator when the **PF** code flashes.

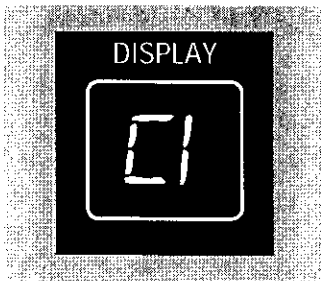

This flashing code tells you to check the automatic icemaker. Ice clumps in the storage bin may have stalled the icemaker. Follow corrective measures described in *Troubleshooting Tips*. If water supply to the icemaker is not connected or not turned on, make sure the icemaker feeler arm is in the **STOP** (up) position. Code stops flashing when problem is corrected or **SYSTEM CHECK-RESET** pad is touched.

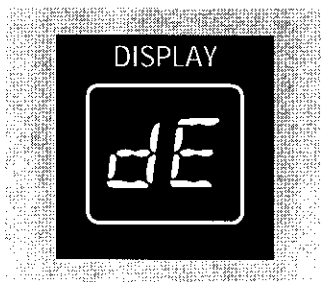

This flashing code tells you something is wrong with the defrost system—keep doors closed to retain cold and call for service. Code flashes until problem is corrected.

About the controls on the refrigerator.

How To Test Temperatures

Use the milk test for the fresh food compartment. Place a container of milk on the top shelf and check it a day later. If the milk is too warm or too cold, adjust the temperature controls.

Use the ice cream test for the freezer compartment. Place a container of ice cream in the center of the freezer and check it after a day. If it's too hard or too soft, adjust the temperature controls.

After changing the controls, allow 24 hours for the refrigerator to reach the temperature you have set.

Food Storage

The type of packaging used and the storage temperatures will affect how long food will keep in the refrigerator.

New food storage guidelines are constantly being developed.

Consult the County Extension Service for the latest information on freezing and storing foods.

Automatic Energy Saver System

You won't find an **energy saver** switch on this refrigerator.

Warm liquid from the refrigerator's condenser is automatically circulated around the front edge of the freezer compartment to help keep moisture from forming on the outside of the refrigerator during humid weather.

Many refrigerators use special electric heaters. This refrigerator needs none. That's why there is no **energy saver** switch...there's no need for it.

About the refrigerator shelves and dishes.

Not all features are on all models.

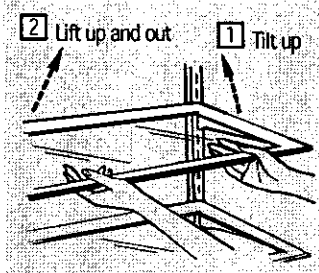

To Remove

Rearranging the Shelves

Shelves in the fresh food and freezer compartments are adjustable.

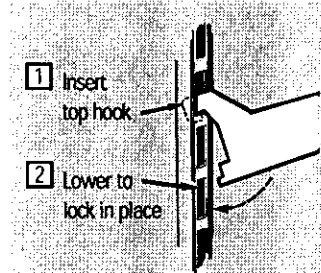

To Replace

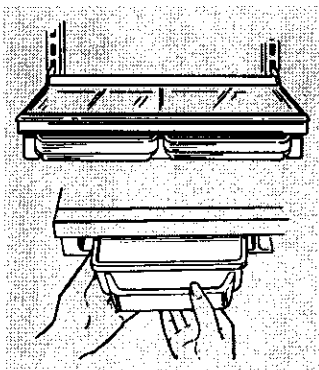

Quick Serve™ System

CAUTION: Dishes and lids are not designed for use on the range top, broiler or in the regular oven. Such use can be hazardous.

Quick Serve™ dishes fit into a space-saving rack under the shelf. The rack can be relocated anywhere in the fresh food compartment.

Dishes and lids are safe for use in microwave ovens, refrigerators and freezers.



Do not use when cooking high-fat foods, such as bacon, and high-sugar foods, such as candy and syrup. The high temperatures of the fat and sugar can cause bubbles to form on the inside of the dish.

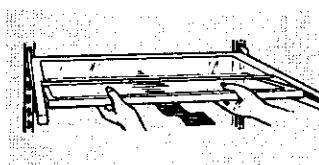

Quick Space Shelf

This shelf splits in half and slides under itself for storage of tall items on the shelf below.

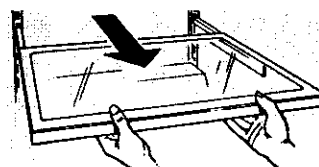

Slide-Out Spillproof Shelf

The slide-out spillproof shelf allows you to reach items stored behind others. The special edges are designed to help prevent spills from dripping to lower shelves.

Make sure you push the shelves all the way back in before you close the door.

About the storage drawers.

Not all features are on all models.

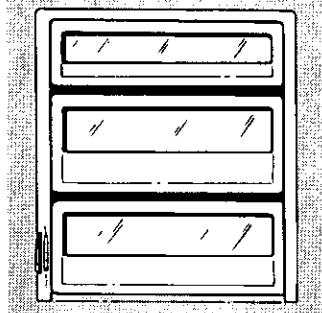

Fruit and Vegetable Drawers

Excess water that may accumulate in the bottom of the drawers should be emptied and the drawers wiped dry.

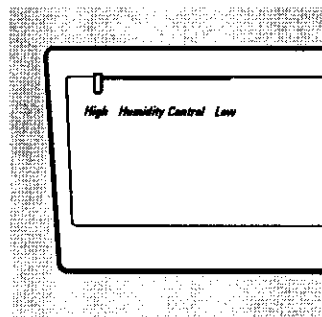

Adjustable Humidity Drawers

Slide the control all the way to the **HIGH** setting to provide high humidity recommended for most vegetables.

Slide the control all the way to the **LOW** setting to provide lower humidity levels recommended for most fruits.

Sealed Snack Pack

The sealed snack pack can be moved to the most useful location for your family's needs.

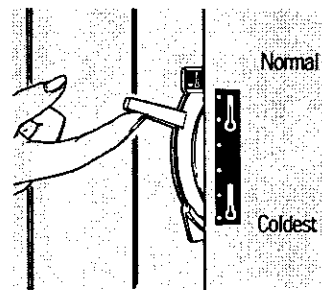

Convertible Meat Drawer

The convertible meat drawer has its own cold air duct to allow a stream of cold air from the freezer compartment to flow around the drawer.

The variable temperature control regulates the air flow from the freezer compartment.

Set control lever **down** to the coldest setting to store fresh meats. If lever is left in meat position for a long period of time, some frost may form on the inside of the drawer.

Set control lever **up** to convert the drawer to normal refrigerator temperature and provide extra vegetable storage space. Cold air duct is turned off. Variable settings between these extremes can be selected.

About storage drawer removal.

Not all features are on all models.

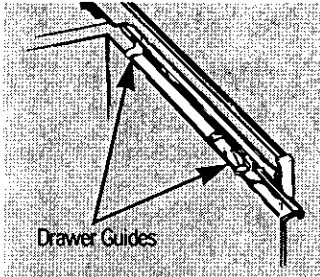

When replacing the drawers, make sure you slide them through both drawer guides on the right side.

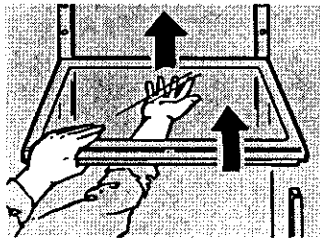

Drawer Removal

Drawers can easily be removed by tilting up slightly and pulling past the **stop** location.

Remove the door bins from the fresh food door before removing the drawer.

To remove the shelf above the top drawer, first remove the top drawer and any food on the shelf. Then tilt the shelf up at the front and lift it up and out of the tracks.

To replace the shelf, raise the shelf front slightly and place the top hooks in the lowest large track slots. Then lower the front of the shelf until it is level.

To remove the drawers when the fresh food compartment door cannot be opened fully you need to roll the refrigerator forward until the door can be fully opened. In some cases this will require moving the refrigerator to the left as you roll it out.

About the additional features.

Not all features are on all models.

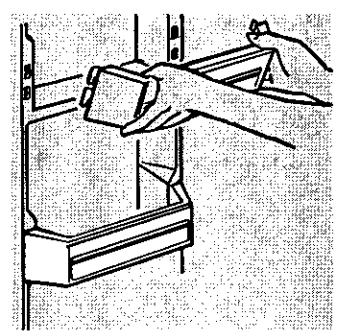

Deep Door Shelves in the Freezer Compartment

Detachable shelf extenders deepen and enclose fixed door shelves, providing more storage room and greater storage flexibility.

To remove: Lift the shelf extender straight up until the mounting hooks come out of the slots in the door.

To replace: Line up the hooks with the slots in the door and push in and down.

Removable Wine Rack

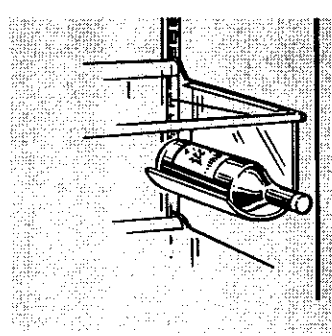

Freezer Baskets

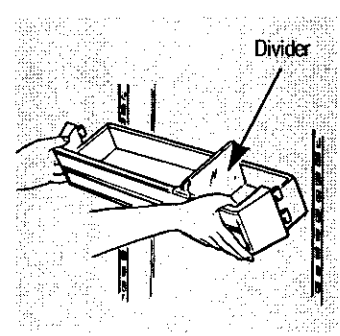
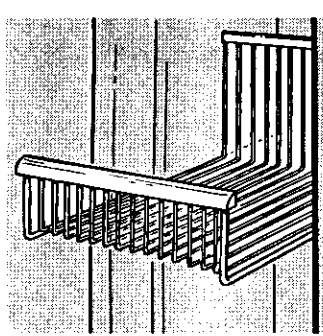

Bins on the Fresh Food Compartment Door

Adjustable bins can easily be carried from refrigerator to work area.

To remove: Lift bin straight up until mounting hooks disengage.

To replace or relocate: Select desired shelf height, engage bin's hook in slots on the tracks of the door, and push in. Bin will lock in place.

The divider helps prevent tipping, spilling or sliding of small items stored on the door shelf. Place a finger on either side of the divider near the front and move it back and forth to fit your needs.

About the refreshment center.

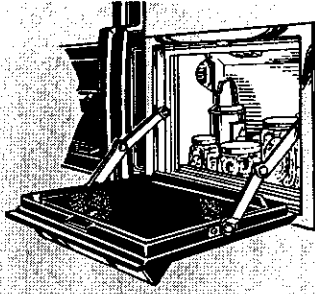

Refreshment Center Compartment

It makes frequently used items stored on the fresh food door readily accessible through the refreshment center compartment door without having to open the main refrigerator door.

It provides an extra counter-high work surface with its own light right at the refrigerator when the refreshment center compartment door is open. Close the door after use.

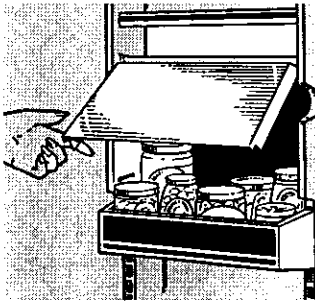

Although durable, stain- and scratch-resistant, the work surface on the refreshment center counter should not be used as a cutting board. Sharp utensils can damage it.

Cold air entering from the freezer compartment keeps the temperature in the refreshment center compartment at proper food-keeping levels.

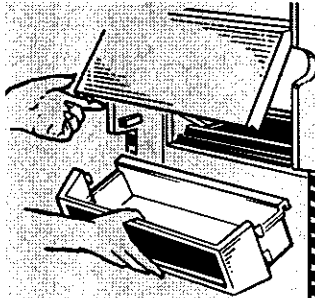

The refreshment center compartment is also accessible through a lift-up door on the inside of the fresh food compartment door.

To remove the refreshment center bin, open the outer door to free the lip on the bin from the overlapping door.

Then raise the inner door and lift the bin straight up until hooks on bin come out of tracks on door.

Refreshment center bin must be replaced in its original position.

About the automatic icemaker.

A newly-installed refrigerator may take 8 to 12 hours to begin making ice.

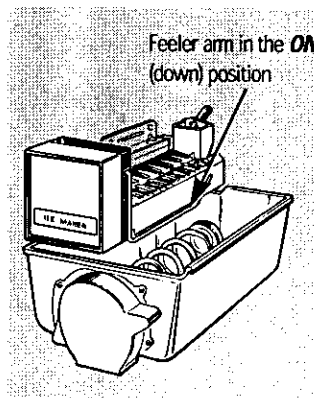
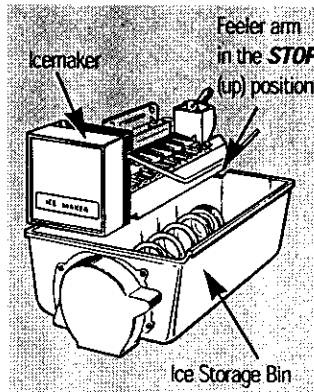
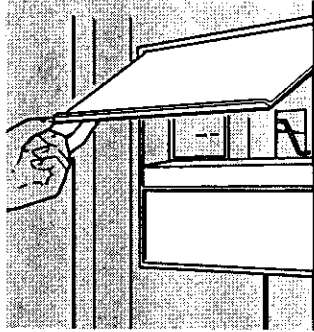

Automatic Icemaker

The icemaker will produce eight cubes per cycle—approximately 120 cubes in a 24-hour period, depending on freezer compartment temperature, room temperature, number of door openings and other use conditions.

If the refrigerator is operated before the water connection is made to the icemaker, raise the ice access door and make sure the feeler arm is in the **STOP** (up) position.

When the refrigerator has been connected to the water supply, move the feeler arm to the **ON** (down) position.

The icemaker will fill with water when it cools to freezing. A newly-installed refrigerator may take 8 to 12 hours to begin making ice cubes.

Throw away the first few batches of ice to allow the water line to clear.

Be sure nothing interferes with the swing of the feeler arm.

It is normal for several cubes to be joined together.

If ice is not used frequently, old ice cubes will become cloudy and taste stale.

About the ice and water dispenser.



To Use the Dispenser

Press the rim of the glass gently against the dispenser pad.

Select **CUBED ICE**, **CRUSHED ICE** (on some models) or **CHILLED WATER**.

The spill shelf is not self-draining. To reduce water spotting, the shelf and its grille should be cleaned regularly.

If no water is dispensed when the refrigerator is first installed, there may be air in the water line system. Press the dispenser pad for at least two minutes to remove trapped air from the water line and to fill the water system. To flush out impurities in the water line, throw away the first six glassfuls of water.

A light switch (on some models) turns the **night light** in the dispenser on or off. The light also comes on when the dispenser pad is pressed. The light in the dispenser should be replaced with a 7 watt maximum bulb when it burns out.

CAUTION: Never put fingers or any other objects into the ice crusher discharge opening.

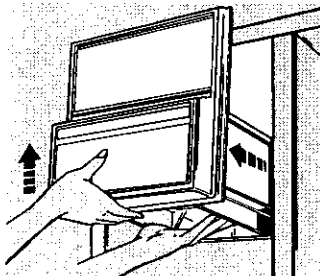

Ice Storage Bin

To remove:

Lift the left corner to free the bin from the shelf. Pull the bin straight out while supporting it at front and back.

To replace:

Slide the bin back until the tab on the bin locks into the slot on the shelf. If the bin does not go all the way back, remove it and turn the drive mechanism 1/4 turn. Then push the bin back again until the tab on the bin locks into the slot on the shelf.

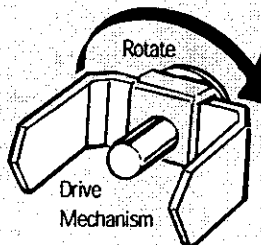

About the ice and water dispenser.

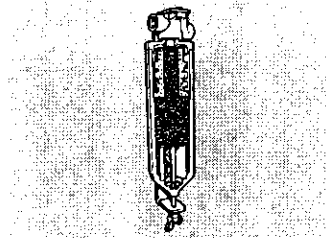

Water Filter Accessory

The water filter is an option at extra cost and is available from your dealer. Specify WR97X0214. It has complete installation instructions and installs on 1/4" O.D. copper water line.

Important Facts About Your Dispenser

- Add ice before filling the glass with a beverage.
- Do not add ice from trays or bags to the storage bin. It may not crush or dispense well.
- Avoid overfilling glass with ice and use of narrow or extra-tall glasses. Backed-up ice can jam the chute or cause the door in the chute to freeze shut. If ice is blocking the chute, poke it through with a wooden spoon.
- Beverages and foods should not be quick-chilled in the ice storage bin. Cans, bottles or food packages in the storage bin may cause the icemaker or auger to jam.
- Some crushed ice may be dispensed even though you selected **CUBED ICE**. This happens occasionally when a few cubes accidentally get directed to the crusher.
- After crushed ice is dispensed, some water may drip from the chute.
- Sometimes a mound of snow will form on the door in the ice chute. This condition is normal and usually occurs when you have dispensed crushed ice repeatedly. The snow will eventually evaporate.
- Dispensed water is not ice cold. For colder water, add crushed ice or cubes before dispensing water.

Care and cleaning of the refrigerator.

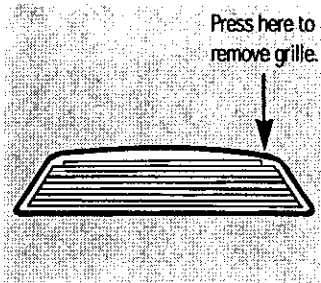

Cleaning the Outside

Refreshment center compartment door—outside. It's important that you use only window cleaner without ammonia or a damp cloth to clean the glass and trim. Avoid using wax on the refreshment center door.

The dispenser well, beneath the grille, should be wiped dry. Water left in the well may leave deposits. Remove the deposits by adding undiluted vinegar to the well. Soak until the deposits disappear or become loose enough to rinse away.

The dispenser pad. Clean with warm water and baking soda solution—about a tablespoon (15 ml) of baking soda to a quart (1 L) of water. Rinse thoroughly and wipe dry.

HINT: Open the freezer door part way to prevent dispensing of ice or water when cleaning.

The soft door handles are easy to keep clean if they are waxed every few months. Use a household wax such as Pledge brand or Jubilee brand to coat the handles. Clean with soapy water or a non-abrasive, all-purpose cleaner.

Keep the outside clean. Wipe with a clean cloth lightly dampened with kitchen appliance wax or mild liquid dish detergent. Dry and polish with a clean, soft cloth.



Do not wipe the refrigerator with a soiled dish cloth or wet towel. These may leave a residue that can erode the paint. Do not use scouring pads, powdered cleaners, bleach or cleaners containing bleach because these products can scratch and weaken the paint finish.

Care and cleaning of the refrigerator.

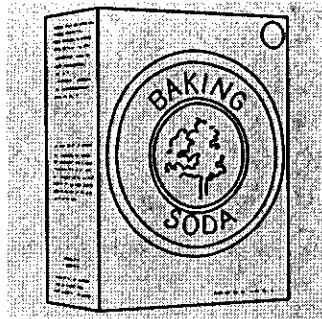

Cleaning the Inside

Refreshment center compartment door—inside. Wipe up spills right away. Use one tablespoon (15 ml) of baking soda in one quart (1 L) of water to clean the inside door surface, refreshment center bin and inside access door. Rinse, wipe dry.

To help prevent odors, leave an open box of baking soda in the fresh food and freezer compartments.

Unplug the refrigerator before cleaning. If this is not practical, wring excess moisture out of sponge or cloth when cleaning around switches, lights or controls.

Use warm water and baking soda solution—about a tablespoon (15 ml) of baking soda to a quart (1 L) of water. This both cleans and neutralizes odors. Rinse and wipe dry.

After cleaning the door gaskets, apply a thin layer of petroleum jelly to the door gaskets at the hinge side. This helps keep the gaskets from sticking and bending out of shape.

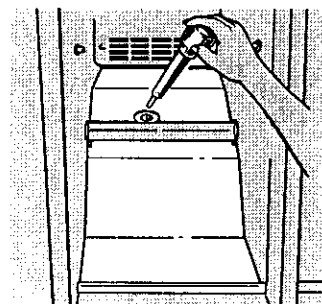

Drain opening in freezer compartment. During yearly cleaning, remove bottom freezer basket and flush a solution of baking soda—1 teaspoon (5 ml) and 2 cups (500 ml) of hot (not boiling) water—through the drain line with the help of a meat baster. This will help eliminate odor and reduce the likelihood of a clogged drain line. If drain becomes clogged, use a meat baster and baking soda solution to force the clog through the drain line.



Avoid cleaning cold glass shelves (on some models) with hot water because the extreme temperature difference may cause them to break. Handle glass shelves carefully. Bumping tempered glass can cause it to shatter.

Do not wash any plastic refrigerator parts in the dishwasher except Quick Serve dishes and lids.

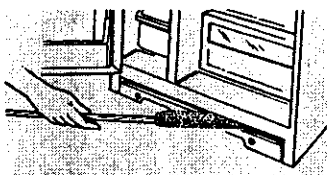

Clean the condenser coils at least once a year.

Under the Refrigerator

For most efficient operation, keep the area under the refrigerator clean. Remove the base grille and sweep away or vacuum up dust.

For best results, use a brush specially designed for this purpose. It is available at most appliance parts stores.

Behind the Refrigerator

Be careful when moving the refrigerator away from the wall. All types of floor coverings can be damaged, particularly cushioned coverings and those with embossed surfaces.

Pull the refrigerator straight out and return it to position by pushing it straight in. Moving the refrigerator in a side direction may result in damage to the floor covering or refrigerator.

When pushing the refrigerator back, make sure you don't roll over the power cord or icemaker supply line.

Preparing for Vacation

For long vacations or absences, remove food and unplug the refrigerator. Move the fresh food control to the **OFF** position, and clean the interior with a baking soda solution of one tablespoon (15 ml) of baking soda to one quart (1 L) of water. Leave the doors open.

Move the icemaker feeler arm to the **STOP** (up) position and shut off the water supply to the refrigerator.

If the temperature can drop below freezing, have a qualified servicer drain the water supply system to prevent serious property damage due to flooding.

Preparing to Move

Secure all loose items such as grille, shelves and drawers by taping them securely in place to prevent damage.

Be sure the refrigerator stays in an upright position during moving.

Replacing the light bulbs.

Turning the control to the **OFF** position does not remove power to the light circuit.

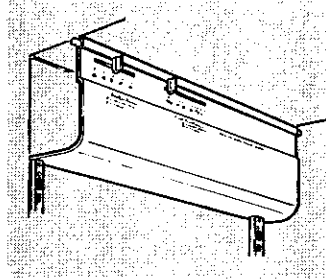

Fresh Food Compartment-Upper Light

- 1 Unplug refrigerator.
- 2 Pull off the temperature control knobs.
- 3 Pull bottom of the light shield down and forward, then rotate the top up and off.

After replacing with an appliance bulb of the same or lower wattage, reinstall the light shield and plug the refrigerator back in.

Fresh Food Compartment-Two Lower Lights (on some models)

These lights are located behind the top drawer.

- 1 Unplug the refrigerator and remove the top drawer and cover.
- 2 Grasp the bottom edge of the shield and pull forward and up to free its bottom edge.

After replacing with an appliance bulb of the same or lower wattage, replace the shield, drawer and cover and plug the refrigerator back in.

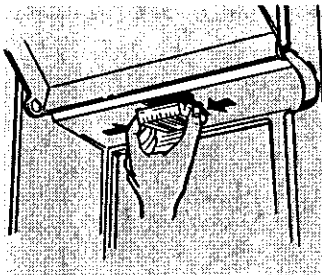

Refreshment Center (on some models)

- 1 Unplug the refrigerator.
- 2 Open fresh food compartment door, remove top bin and raise refreshment center inner door.
- 3 Press sides of flexible light shield to release locking tabs and allow the shield to swing down.

Unscrew burned-out bulb and replace it with an appliance bulb of the same or lower wattage. Place rear tab of light shield into door and rotate shield up until tabs lock into slots above. Plug refrigerator back in.

Freezer Compartment

- 1 Unplug the refrigerator.
- 2 Remove the shelf just below light shield.
- 3 Pull the light shield toward you to reach the bulb.

After replacing with an appliance bulb of the same or lower wattage, reinstall the shield and shelf, and plug the refrigerator back in.

Preparing to install the refrigerator.

Read these instructions completely and carefully.



Water Supply to the Icemaker

You will need to connect the icemaker to a cold water line.

A water supply kit (containing copper tubing, shutoff valve, fittings and instructions) is available at extra cost from your dealer.



Refrigerator Location

Do not install the refrigerator where the temperature will go below 60°F. (16°C.) because it will not run often enough to maintain proper temperatures.

Install it on a floor strong enough to support it fully loaded.

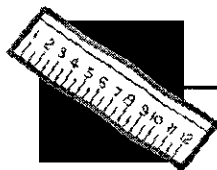

Clearances

Allow the following clearances for ease of installation, proper air circulation and plumbing and electrical connections:

Sides 5/8" (15 mm)

Top 1" (25 mm)

If built-in, allow 7/8" [22 mm] for hinge covers.

Back 1" (25 mm)

If the refrigerator is against a wall on either side, allow the following door clearances:

For 24' models:

Refreshment center side 2 5/8" (67 mm)

Freezer side 3/4" (19 mm)

For 27' models:

Refreshment center side 3 1/2" (89 mm)

Freezer side 1 1/2" (38 mm)

Rollers

The rollers have 3 purposes:

- 1 Rollers adjust so the door closes easily when opened about halfway.
[Raise the front about 5/8" (15 mm) from the floor.]
- 2 Rollers adjust so the refrigerator is firmly positioned on the floor and does not wobble.
- 3 Rollers allow you to move the refrigerator away from the wall for cleaning.

To adjust the rollers, remove the base grille by pulling it out at the bottom.

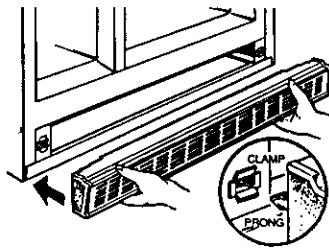

Turn the roller adjusting screws **clockwise to raise** the refrigerator, **counterclockwise to lower** it. Use an adjustable wrench (3/8" hex head bolt) or pliers.

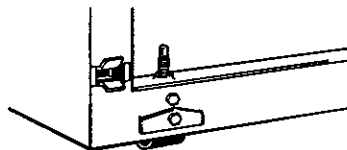

To replace base grille, align prongs on back of grille with clamps in cabinet and push forward until grille snaps into place.

Installing the water line.

Read these instructions completely and carefully.



Before You Begin

This water line installation is not warranted by the refrigerator or icemaker manufacturer. Follow these instructions carefully to minimize the risk of expensive water damage.

Water hammer (water banging in the pipes) in house plumbing can cause damage to refrigerator parts and lead to water leakage or flooding. Call a qualified plumber to correct water hammer before installing the water supply line to the refrigerator.

To prevent burns and product damage, do not hook up the water line to the hot water line.

*If you use your refrigerator before connecting the water line, make sure the icemaker feeler arm is kept in the **STOP** (up) position.*

Do not install the icemaker tubing in areas where temperatures fall below freezing.

When using any electrical device (such as a power drill) during installation, be sure the device is insulated or wired in a manner to prevent the hazard of electric shock.

All installations must be in accordance with local plumbing code requirements.



What You Will Need

To determine how much copper tubing you need:

Measure the distance from the water valve on the back of the refrigerator to the water supply pipe. Then add 8 feet (244 cm). Be sure there is sufficient extra tubing [about 8 feet (244 cm) coiled into 3 turns of about 10 inches (25 cm) diameter] to allow the refrigerator to move out from the wall after installation.

■ **A cold water supply.** The water pressure must be between 20 and 120 p.s.i.

■ **Power drill.**

■ **Copper tubing,** 1/4" outer diameter to connect the refrigerator to the water supply. Be sure both ends of the tubing are cut square.

Do not use plastic tubing or plastic fittings because the water supply line is under pressure at all times. Certain types of plastic tubing may become brittle with age and crack, resulting in water leakage.

■ **Two 1/4" outer diameter compression nuts and 2 ferrules (sleeves)**—to connect the copper tubing to the shutoff valve and the refrigerator water valve.

■ If your existing water line has a flared fitting at the end, you will need an **adapter** (available at plumbing supply stores) to connect the water line to the refrigerator **OR** you can cut off the flared fitting with a **tube cutter** and then use a compression fitting.

■ **Shutoff valve** to connect to the cold water line. The shutoff valve should have a water inlet with a minimum inside diameter of 5/32" at the point of connection to the **COLD WATER LINE**. Saddle-type shutoff valves are included in many water supply kits. Before purchasing, make sure a saddle-type valve complies with your local plumbing codes.

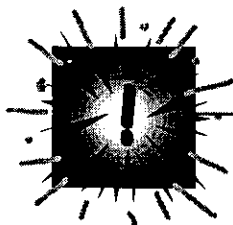

Shut Off the Main Water Supply

Turn on the nearest faucet long enough to clear the line of water.

Installing the water line.

Read these instructions completely and carefully.

Install the Shutoff Valve

- 1 Install the shutoff valve on the nearest frequently used drinking water line.
- 2 Choose a location for the valve that is easily accessible. It is best to connect into the side of a vertical water pipe. When it is necessary to connect into a horizontal water pipe, make the connection to the top or side, rather than at the bottom, to avoid drawing off any sediment from the water pipe.
- 3 Drill a 1/4" hole in the water pipe, using a sharp bit. Remove any burrs resulting from drilling the hole in the pipe.
- 4 Fasten the shutoff valve to the cold water pipe with the pipe clamp.
- 5 Tighten the clamp screws until the sealing washer begins to swell.

Do not overtighten or you may crush the copper tubing.

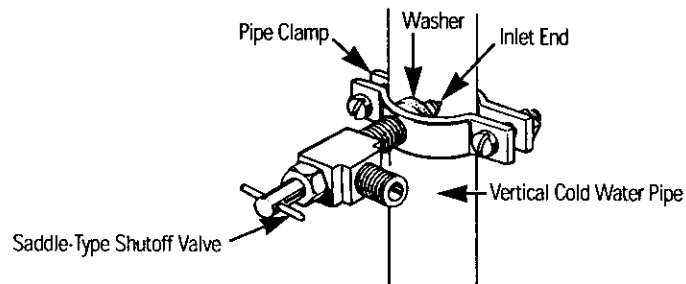

Route the Copper Tubing and Connect It to the Shutoff Valve

Route the copper tubing between the cold water line and the refrigerator.

Route the tubing through a hole drilled in the wall or floor (behind the refrigerator or adjacent base cabinet) as close to the wall as possible.

Be sure there is sufficient extra tubing [about 8 feet (244 cm) coiled into 3 turns of about 10" (25 cm) diameter] to allow the refrigerator to move out from the wall after installation.

Place the compression nut and ferrule (sleeve) onto the end of the tubing and connect it to the shutoff valve.

Make sure the tubing is fully inserted into the valve. Tighten the compression nut securely.

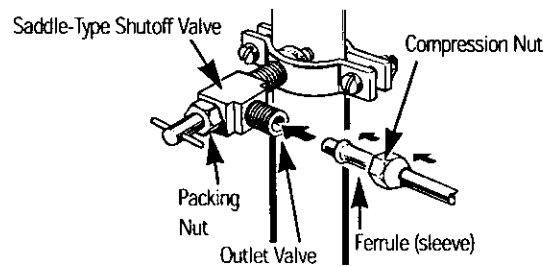

Turn On the Water and Flush Out the Tubing

- 1** Turn the main water supply on and flush out the tubing until the water is clear.
- 2** Shut the water off at the water valve after about one quart (1 L) of water has been flushed through the tubing.

Installing the water line.

Read these instructions completely and carefully.

Connect the Tubing to the Refrigerator

Before making the connection to the refrigerator, be sure the refrigerator power cord is not plugged into the wall outlet.

We recommend installing a water filter if your water supply has sand or particles that could clog the screen of the refrigerator's water valve. Install it in the water line near the refrigerator.

- 1 Remove the plastic flexible cap from the water valve.
- 2 Place the compression nut and ferrule (sleeve) onto the end of the tubing as shown.
- 3 Insert the end of the copper tubing into the water valve connection as far as possible. While holding the tubing, tighten the fitting.
- 4 Fasten the copper tubing into the clamp provided to hold it in a vertical position. You may need to pry open the clamp.

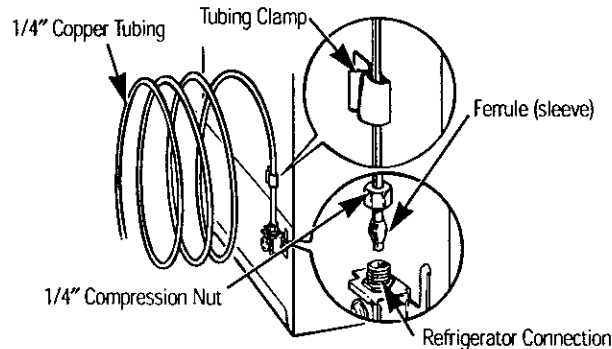

Turn the Water On at the Shutoff Valve

Tighten any connections that leak.

Plug In the Refrigerator

Arrange the coil of copper tubing so that it does not vibrate against the back of the refrigerator or against the wall.

Push the refrigerator back to the wall.

Start the Icemaker

Set the icemaker feeler arm to the **ON** (down) position. The icemaker will not begin to operate until it reaches its operating temperature of 15°F. (-9°C.) or below. It will then begin operation automatically if the icemaker feeler arm is in the **ON** (down) position.

NOTE: The icemaker may double-cycle when it first starts, causing some water spillage from the icemaker into the ice bucket. This is normal and should not happen again.

Normal operating sounds.



Depending on the placement of the refrigerator in your kitchen, you may want to place a piece of rubber backed carpet under the refrigerator to reduce noise.

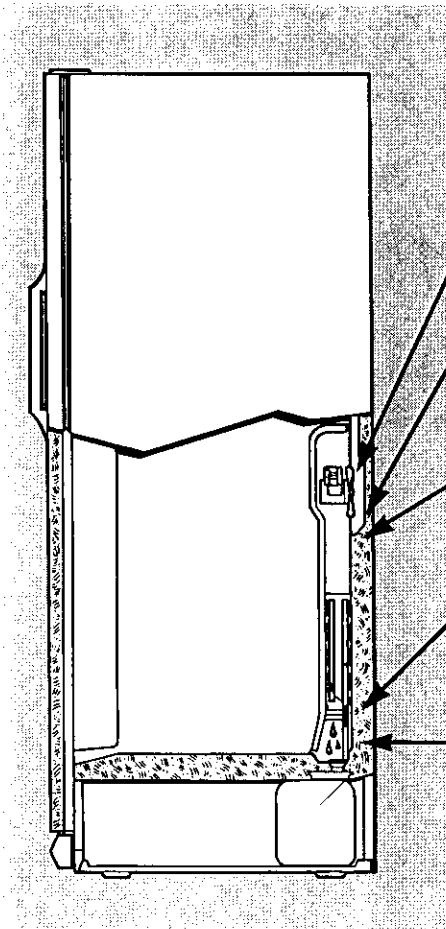

The new high efficiency compressor runs faster and will have a higher pitch hum or pulsating sound while operating.

Defrost timer and refrigerator control clicks on and off.

The fan circulating air inside the freezer which keeps the temperatures throughout.

Water dropping on the defrost heater causing a sizzling, hissing or popping sound during the defrost cycle.

The flow of refrigerant through the freezer cooling coil sounds like boiling water or a gurgling noise.

Cracking or popping of cooling coils caused by expansion and contraction during defrost and refrigeration following defrost.

Water dripping as it melts from the evaporator and flows to the drain pan during the defrost cycle.

Icemaker

The icemaker water valve will buzz when the icemaker fills with water. If the feeler arm is in the **ON** (down) position it will buzz even if it has not yet been hooked up to water. Keeping the feeler arm in the **ON** (down) position before it is hooked up to water can damage the icemaker. To prevent this, raise the feeler arm to the **STOP** (up) position. This will stop the buzzing.

The sound of cubes dropping into the bin and water running in pipes as icemaker refills.

These sounds are normal and are due mostly to highly efficient operation.

Before you call for service...

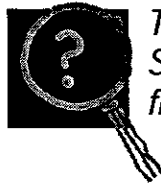

Troubleshooting Tips

Save time and money! Review the charts on the following pages first and you may not need to call for service.

Problem	Possible Causes	What To Do
Refrigerator does not operate	Refrigerator in defrost cycle.	• Wait about 30 minutes for defrost cycle to end.
	Fresh food control in OFF position.	• Move the fresh food control to desired temperature setting.
	Refrigerator is unplugged.	• Make sure the refrigerator plug is pushed completely into the outlet.
	The fuse is blown/circuit breaker is tripped.	• Check the house fuse/circuit breaker box and replace fuse or reset the breaker.
Motor operates for long periods	Modern refrigerators with more storage space and a larger freezer compartment require more operating time.	• This is normal.
	Normal when refrigerator is first delivered to your home.	• Wait 24 hours for the refrigerator to completely cool down.
	Often occurs when large amounts of food are placed in refrigerator to be cooled or frozen.	• This is normal.
	Door left open.	• Check to see if package is holding door open.
	Hot weather or frequent door openings.	• This is normal.
	Temperature controls set at the coldest setting.	• See the <i>About the controls on the refrigerator</i> section.
	Grille and condenser need cleaning.	• See the <i>Care and cleaning</i> section.

Problem	Possible Causes	What To Do
Motor starts and stops frequently	Temperature control starts and stops motor to maintain even temperatures.	<ul style="list-style-type: none"> • This is normal.
Vibration or rattling	Front roller screws or front leveling legs need adjusting.	<ul style="list-style-type: none"> • See the <i>Rollers</i> section.
	Slight vibration is normal.	<ul style="list-style-type: none"> • Try moving dishes around in refrigerator.
Fresh food or freezer compartment too warm	Temperature control not set cold enough.	<ul style="list-style-type: none"> • See the <i>About the controls on the refrigerator</i> section.
	Warm weather or frequent door openings.	<ul style="list-style-type: none"> • Set the temperature control one step colder. See the <i>About the controls on the refrigerator</i> section.
	Door left open.	<ul style="list-style-type: none"> • Check to see if package is holding door open.
Frost or ice crystals on frozen food	Door left open.	<ul style="list-style-type: none"> • Check to see if package is holding door open.
	Too frequent or too long door openings.	
	Frost within package is normal.	
Divider between fresh food and freezer compartment feels warm	Automatic energy saver system circulates warm liquid around front edge of freezer compartment.	<ul style="list-style-type: none"> • This helps prevent condensation on the outside.
Automatic icemaker does not work	Icemaker feeler arm in the <i>STOP</i> (up) position.	<ul style="list-style-type: none"> • Move the feeler arm to the ON (down) position. • Cubes may have fused to the side of the mold. Remove these cubes.
	Water supply turned off or not connected.	<ul style="list-style-type: none"> • See the <i>Installing the water line</i> section.
	Freezer compartment too warm.	<ul style="list-style-type: none"> • Wait 24 hours for the refrigerator to completely cool down.
	Piled up cubes in the storage bin may cause the icemaker to shut off prematurely.	<ul style="list-style-type: none"> • Remove storage bin from freezer and level cubes by hand.

Before you call for service...

Problem	Possible Causes	What To Do
Slow ice cube freezing	Door left open.	• Check to see if package is holding door open.
	Temperature control not set cold enough.	• See the <i>About the controls on the refrigerator</i> section.
Ice cubes have odor/taste	Ice storage bin needs cleaning.	• Empty and wash bin. Discard old cubes.
	Food transmitting odor/taste to ice cubes.	• Wrap foods well.
	Interior of refrigerator needs cleaning.	• See the <i>Care and cleaning</i> section.
	Poor-tasting incoming water.	• Install a water filter.
Cube dispenser does not work	Icemaker turned off or water supply turned off.	• Turn on icemaker or water supply.
	Ice cubes are frozen to icemaker feeler arm.	• Remove cubes and move the feeler arm to the ON (down) position.
	Irregular ice clumps in storage container.	• Break up with fingertip pressure and discard remaining clumps. • Freezer temperature may be too warm. Adjust the freezer control to a colder setting, one position at a time, until the clumps do not form.
Water has poor taste/odor	Water dispenser not been used for a long time.	• Dispense water until all water in system is replenished.
	Poor-tasting incoming water.	• Install a water filter.

Problem	Possible Causes	What To Do
Water dispenser does not work	Water supply line turned off or not connected.	• See the <i>Installing the water line</i> section.
	Supply line clogged with sediment.	
	Air may be trapped in the water system.	• Press the dispenser pad for at least two minutes.
Refrigerator has odor	Foods transmitting odor to refrigerator.	• Foods with strong odors should be tightly wrapped. • Keep an open box of baking soda in the refrigerator; replace every three months.
	Spoiled food.	
	Interior needs cleaning.	• See the <i>Care and cleaning</i> section.
	Defrost water drainage system needs cleaning.	• See the <i>Care and cleaning</i> section.
	Moisture forms on outside of refrigerator	Not unusual during periods of high humidity.
Moisture collects inside	Too frequent or too long door openings.	
	In humid weather, air carries moisture into refrigerator when doors are opened.	
Interior light does not work	No power at outlet.	• Check the house fuse/circuit breaker box and replace fuse or reset the breaker.
	Light bulb burned out.	• See the <i>Replacing the light bulbs</i> section.
Door not closing properly	Door gasket on hinge side sticking or folding over.	• Apply petroleum jelly on face of gasket.

Before you call for service...

Problem	Possible Causes	What To Do
Hot air from bottom of refrigerator	Normal air flow cooling motor. In the refrigeration process, it is normal that heat be expelled in the area under the refrigerator. Some floor coverings will discolor at these normal and safe temperatures.	<ul style="list-style-type: none"> Your floor covering supplier should be consulted if you object to this discoloration.
Water on kitchen floor or on bottom of freezer	Drain in the bottom of the freezer clogged. Cubes jammed in chute.	<ul style="list-style-type: none"> See the <i>Care and cleaning</i> section. Use a glass no taller than 6".
No panel touch pad response	If interior light is not on, refrigerator may not be plugged in at wall outlet. Tripped circuit breaker or burned-out fuse.	<ul style="list-style-type: none"> Make sure refrigerator is securely plugged in at wall outlet. Plug a lamp or small appliance into the same outlet to determine if there is power at the outlet.

Consumer Warranty

For customers in Canada

First Year

CAMCO warrants the replacement or repair of all parts of this Refrigerator which prove to be defective in material or workmanship for one year from the date of purchase. Such parts will be repaired or replaced at the option of Camco without charge, subject to the terms and conditions set out below.

The **DEALER** warrants to provide the service labor for the repair or replacement of all parts of this Refrigerator which prove to be defective in material or workmanship for one year from the date of purchase.

Next Four Years

CAMCO warrants the hermetically sealed refrigerator (namely: Evaporator, Condenser, Motor Compressor, Interconnecting Tubing, Drier and Refrigerant Charge) against defects in material or workmanship for an additional four years. These parts will be repaired or replaced at the option of Camco without charge, subject to the terms and conditions set out below.

The **DEALER** warrants for the next four years to provide the service labor necessary to repair or replace the hermetically sealed refrigeration system to the terms and conditions set out below.

Terms and Conditions

- This warranty applies only to single family domestic use in Canada when the Refrigerator has been properly installed according to the instructions supplied by Camco and is connected to an adequate and proper utility service. Damage due to abuse, accident, commercial use, and alteration or the removal or defacing of the serial plate, cancels all obligations of this warranty. Service during this warranty must be performed by an Authorized Camco Service Agent.
- Neither Camco nor the Dealer is liable for any claims or damages resulting from any failure of the Refrigerator or from service delays beyond their reasonable control.
- To obtain warranty service, purchaser must present the original bill of sale. Components repaired or replaced are warranted through the remainder of the original warranty period only.
- This warranty does not cover expense involved in making this appliance readily accessible for servicing.
- This warranty gives you specific legal rights. Additional warranty rights may be provided by law in some areas.

Camco Service is available coast-to-coast. See Customer Service section for service information. If further help is needed concerning this Warranty, contact:

*Manager, Consumer Relations, Camco Inc., Consumer Service,
5800 Keaton Crescent, Mississauga, Ontario, L5R 3K2*

Refrigerator Warranty *(For customers in the United States)*



All warranty service provided by our Factory Service Centers, or an authorized Customer Care® technician. For service, call 800-GE-CARES.

For The Period Of	GE Will Replace, At No Charge To You:
One Year From the date of the original purchase	Any part of the refrigerator which fails due to a defect in materials or workmanship. During this full one-year warranty , GE will also provide, free of charge , all labor and in-home service to replace the defective part.
Five Years From the date of the original purchase	Any part of the sealed refrigerating system (the compressor, condenser, evaporator and all connecting tubing) which fails due to a defect in materials or workmanship. During this five-year warranty , GE will also provide, free of charge , all labor and in-home service to replace the defective part.
Lifetime From the date of the original purchase	Any see-through pan or drawer furnished with the refrigerator if the pan or drawer breaks during normal household use. Drawer covers are not included.

What GE Will Not Cover

- Service trips to your home to teach you how to use the product.
- Improper installation.
- Failure of the product if it is abused, misused, or used for other than the intended purpose or used commercially.
- Loss of food due to spoilage.
- Replacement of house fuses or resetting of circuit breakers.
- Damage to the product caused by accident, fire, floods or acts of God.
- Incidental or consequential damage to personal property caused by possible defects with this appliance.

This warranty is extended to the original purchaser and any succeeding owner for products purchased for home use within the USA. In Alaska, the warranty excludes the cost of shipping or service calls to your home.

Some states do not allow the exclusion or limitation of incidental or consequential damages. This warranty gives you specific legal rights, and you may also have other rights which vary from state to state. To know what your legal rights are, consult your local or state consumer affairs office or your state's Attorney General.