

This Owner's Manual is provided and hosted by [Appliance Factory Parts](http://www.appliancefactoryparts.com).



MIDEA 405.84086411 - Sears Owner's Manual

[Shop genuine replacement parts for MIDEA
405.84086411 - Sears](#)



[Find Your MIDEA Air Conditioner Parts - Select From 1120 Models](#)

----- Manual continues below -----

Use & Care Guide
Manual de Uso y Cuidado

Kenmore® Portable Air Conditioner

Aire Acondicionado Portatil

Models/Modelos: 405.84086 , 405.84106

Sears Brands Management Corporation
Hoffman Estates, IL 60179 U.S.A.

www.kenmore.com

www.sears.com

www.kmart.com



TABLE OF CONTENTS

Before Using Your New Air Conditioner.....	2
Warranty.....	2
Important Safety Instructions.....	3-5
Electrical Requirements.....	6
Parts and Features.....	7
Installation Instructions.....	8-12
Operation.....	13-16
Using The Remote Control.....	17-25
Care And Maintenance.....	26
Troubleshooting.....	27
Master Protection Agreement.....	28

BEFORE USING YOUR NEW AIR CONDITIONER

Read this guide. It will help you operate your new Kenmore Air Conditioner in the safest and most effective way.

Keep this book and your sales check (receipt) in a safe place for future reference.

WARRANTY

Kenmore One Year Limited Warranty When installed, operated and maintained according to all supplied instructions, if this appliance fails due to a defect in material and workmanship within one year from the date of purchase, call 1-800-4-MY-HOME® to arrange for free repair. If this appliance is ever used for other than private family purposes, this warranty applies for only 90 days from the date of purchase.

This warranty covers ONLY defects in material and workmanship, and will NOT pay for:

1. Expendable items that can wear out from normal use, including but not limited to filters, belts, incandescent light bulbs and bags.
2. A service technician to instruct the user in correct product installation, operation or maintenance.
3. A service technician to clean or maintain this product.
4. Damage to or failure of this product if it is not installed, operated or maintained according to all instructions supplied with the product.
5. Damage to or failure of this product resulting from accident, abuse, misuse or use for other than its intended purpose.
6. Damage to or failure of this product caused by the use of detergents, cleaners, chemicals or utensils other than those recommended in all instructions supplied with the product.
7. Damage to or failure of parts or systems resulting from unauthorized modifications made to this product.

Disclaimer of implied warranties; limitation of remedies Customer's sole and exclusive remedy under this limited warranty shall be product repair as provided herein. Implied warranties, including warranties of merchantability or fitness for a particular purpose, are limited to one year or the shortest period allowed by law. Sears shall not be liable for incidental or consequential damages. Some states and provinces do not allow the exclusion or limitation of incidental or consequential damages, or limitation on the duration of implied warranties of merchantability or fitness, so these exclusions or limitations may not apply to you.

This warranty applies only while this appliance is used in the United States.

This warranty gives you specific legal rights, and you may also have other rights which vary from state to state.

Sears Brands Management Corporation, Hoffman Estates, IL 60179

IMPORTANT SAFETY INSTRUCTIONS

Read all instructions in this guide before using your Air Conditioner. This product is intended for indoor residential use only, not for industrial or other commercial applications. Use only with electrical wiring that is in good working order and that meets applicable codes and ordinances. If you have any questions whether your wiring is adequate, consult a qualified electrician.

While using your Air Conditioner, you should follow the IMPORTANT SAFETY INSTRUCTIONS listed below. As part of those instructions, we have used the word "▲WARNING" to indicate the level of hazard: ▲WARNING: indicates a hazard which, if not avoided, could result in injury or death.

IMPORTANT INSTRUCTIONS

When using electrical appliances, basic precautions should always be followed to reduce the risk of fire, electric shock, and injury to persons, including the following:

1. Read all instructions before using this Air Conditioner.
2. Use this Air Conditioner only as described in this manual. Any other use not recommended by the manufacturer may cause electrical shock, fire, or injury to persons.
3. Do not operate the Air Conditioner with a damaged power cord or after the Air Conditioner malfunctions or has been dropped in any manner.
4. This appliance is not intended for use by persons (including children) with reduced physical, sensory or mental capabilities, or lack of experience and knowledge, unless they have been given supervision or instruction concerning use of the appliance by a person responsible for their safety.
5. Do not place the Air Conditioner on a small, unlevel, uneven or any surface which might allow unit to tip or fall.
6. For proper operation, Air Conditioner should be placed on a smooth, non combustible surface.
7. Always unplug Air Conditioner when not in use.
8. Do not operate Air Conditioner with any safety devices removed.
9. Do not run power cord under carpeting. Do not cover cord with throw rugs, runners, or the like. Arrange cord away from traffic area where it will not be tripped over.
10. Avoid the use of extension cords due to risk of fire. If an extension cord must be used, the cord must be a minimum 14AWG and rated not less than 1875 watts.
11. Do not insert or allow any object to enter any openings on the Air Conditioner. Doing so may cause electric shock and/or fire hazard.
12. This product is intended for indoor residential use only, not for industrial or other commercial applications. This warranty is void if this product is ever used for other than private household purposes.
13. You will need a level surface at least 6" (15.2 cm) from heat sources such as ranges or heaters.
14. Do not block air openings or place Air Conditioner on a soft surface such as a bed or sofa.

15. The Air Conditioner should be connected to a 115 V, 60 Hz, 15- or 20-amp fused 3 prong grounded outlet.
16. Always insert the filters securely. Clean them every two weeks. Operation without filters may cause failures.

OPERATING CONDITION

- The Air Conditioner must be operated within the temperature range indicated below:

MODE	ROOM TEMPERATURE
COOL	62°F (17°C) ~ 95°F (35°C)
DRY	55°F (13°C) ~ 95°F (35°C)

Suggested tools for window kit installation:

1. Screwdriver (medium size Phillips)
2. Tape measure or ruler
3. Knife or scissors
4. Saw (In the event the window kit needs to be cut down in size because the window is too narrow for direct installation)

⚠ WARNING:

For Your Safety:

- Do not store or use gasoline or other flammable vapors and liquids in the vicinity of this or any other appliance.
- Avoid fire hazard or electric shock. Do not use an extension cord or an adaptor plug. Do not remove any prong from the power cord.

⚠ WARNING:

Electrical Information:

- Be sure the electrical service is adequate for the model you have chosen. This information can be found on the serial plate, which is located on the side of the cabinet and behind the grille.
- Be sure the Air Conditioner is properly grounded. To minimize shock and fire hazards, proper grounding is important. The power cord is equipped with a three-prong grounding plug for protection against shock hazards.
- Your Air Conditioner must be used in a properly grounded wall receptacle. If the wall receptacle you intend to use is not adequately grounded or protected by a time delay fuse or circuit breaker, have a qualified electrician install the proper receptacle.
- Ensure the receptacle is accessible after the unit installation.

⚠ WARNING: SHOCK HAZARD

Never place Air Conditioner where it may fall into a bathtub, sink, flooded area, or any receptacle or pool of water.

⚠ WARNING: FIRE HAZARD

Air Conditioners have arcing or sparking parts inside. Do not use near combustible materials or flammable gases or sources of heat. **DO NOT USE** in areas where gasoline, paint or flammable materials are used or stored. To prevent a possible fire, do not block air intakes or exhaust in any manner. Do not insert or allow foreign objects to enter any intakes or exhaust opening as this may cause an electric shock, fire, or damage the fan.

⚠ WARNING: HOT SURFACES

Do not touch Air Conditioner motor when in use. This motor is hot when in use. To avoid burns, do not let bare skin touch hot surfaces.

SAVE THESE INSTRUCTIONS!

ELECTRICAL REQUIREMENTS

OBSERVE ALL LOCAL CODES AND ORDINANCES.

DO NOT, UNDER ANY CIRCUMSTANCES, REMOVE THE POWER SUPPLY CORD GROUND PRONG.

ELECTRICAL GROUND IS REQUIRED ON THIS APPLIANCE

A 115-VOLT 60Hz, AC ONLY, 15A or 20A FUSED AND PROPERLY GROUNDED ELECTRICAL SUPPLY IS REQUIRED.

A time delay fuse or time delay circuit breaker is recommended. Use a dedicated circuit serving only this appliance.

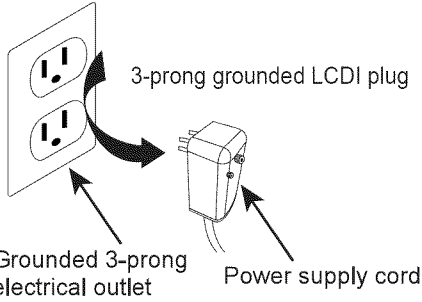

If an extension cord must be used, the cord must be a minimum 14AWG and rated not less than 1875 watts.

RECOMMENDED GROUNDING METHOD

For your personal safety, this appliance must be grounded. This appliance has a power supply cord with a 3-prong grounded plug. To minimize possible shock hazard the cord must be plugged into a matching grounded electrical outlet that complies with the latest edition of the National Electrical Codes and all local codes and ordinances.

If a grounded 3-prong electrical outlet is not available, it is the personal responsibility and obligation of the customer to have one installed by a qualified electrician.

ELECTRICAL SHOCK HAZARD



- Plug into a grounded 3-prong outlet.
- Do not remove the ground pin from the plug.
- Do not use an adapter.
- Failure to follow these instructions can result in death, fire, or electrical shock.

PRODUCT SPECIFICATIONS

MODEL	84086	84106
Voltage	115V~60Hz	115V~60Hz
Amperage: Cooling	8.0 Amps	10.0 Amps
Power Consumption: Cooling	905 Watts	1130 Watts
Cooling Capacity	8,000BTU/h	10,000BTU/H
Dehumidifying Capacity	46 Pints / Day (21.6 Liters / Day)	56 Pints / Day (26.4 Liters / Day)
"Noise" Level dB(A) (H)	57.5	58
Air Circulation (CFM)	250 / 197	244 / 189
Remote Control	INCLUDED	INCLUDED
Dimensions (W x H x D)	14.72"x 30.28" x 14.57"	14.72"x 30.28" x 14.57"
Net Weight	53.57Lbs	56.22 Lbs

PARTS AND FEATURES

FRONT

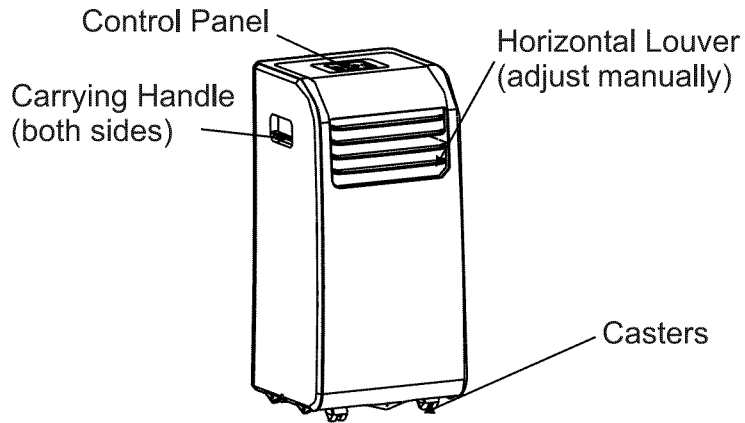

REAR

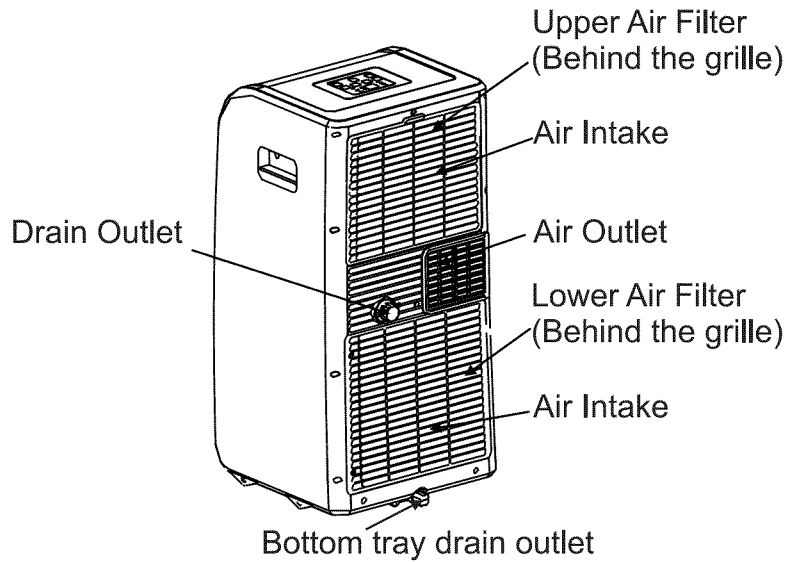

INSTALLATION INSTRUCTIONS

LOCATION

The Air Conditioner should be placed on a firm foundation to minimize noise and vibration. For safe and secure positioning, place the unit on a smooth, level floor strong enough to support the unit.

The unit has casters to aid placement, but it should only be rolled on smooth, flat surfaces. Use caution when rolling on carpet surfaces. Do not attempt to roll the unit over objects.

The unit must be placed within reach of a properly rated grounded socket.

Never place any obstacles around the air inlet or outlet of the unit.

Allow at least 12" of space from the wall for maximum performance.

WINDOW SLIDER INSTALLATION

Your window slider has been designed to fit most standard vertical and horizontal window applications. However, it may be necessary for you to modify some aspects of the installation procedures for certain types of windows. Refer to Fig. 6 and Fig. 7 for minimum and maximum window openings.

Once your window slider is opened to the correct width, insert the supplied screw to secure the window in place (see Fig. 7a).

NOTE: If the window opening is less than the minimum length of the window slider, only use the window slider section with the hole. Cut from the end that is furthest from the section hole. Do not cut any material from the end that is nearest hole.

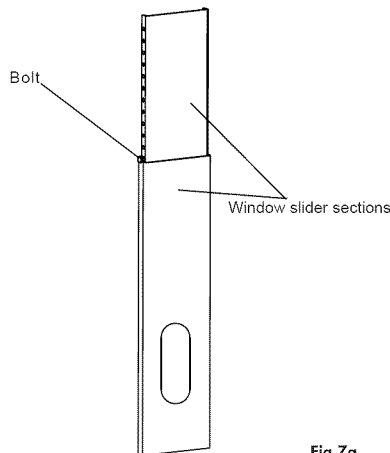
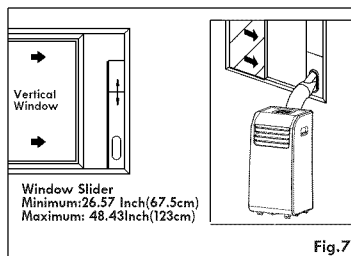
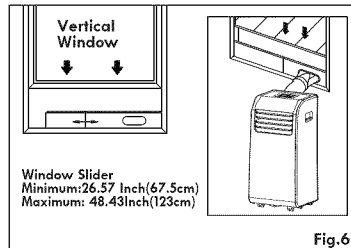
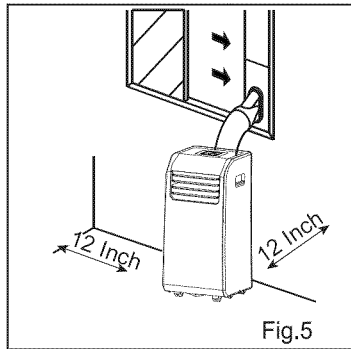

Installation in a double-hung sash window

1. Cut a length of adhesive foam seal the width of the window and attach it to the window stool (see Fig. 8).
2. Place the window slider onto the adhesive foam seal (see Fig. 9). Adjust window slider width according to the instructions on page 8.
3. Cut another length of adhesive foam seal and attach it to the bottom of the window sash. Close the window sash securely onto the window slider (see Fig. 10).
4. Cut the non-adhesive thick foam seal to window width and insert into the open gap between the inner window and outer window sash (see Fig. 11).

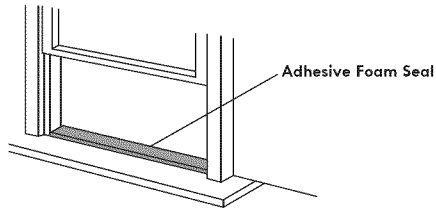

Fig.8

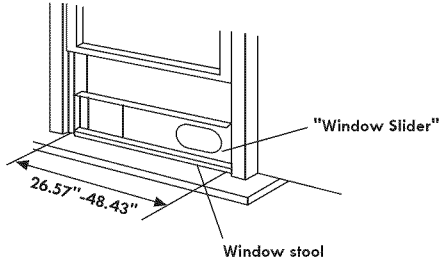

Fig.9

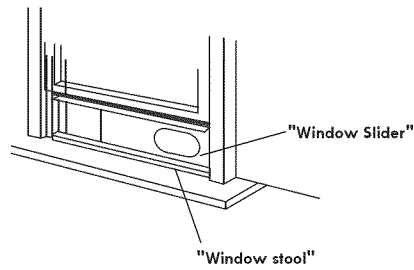

Fig.10

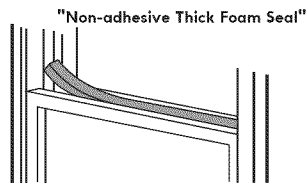

Fig.11

Installation in a sliding sash window

1. Cut a length of adhesive foam seal the height of the window and attach it to the window frame (see Fig. 12).
2. Place the window slider onto the adhesive foam seal (see Fig. 13). Adjust window slider height according to the instructions on page 8.

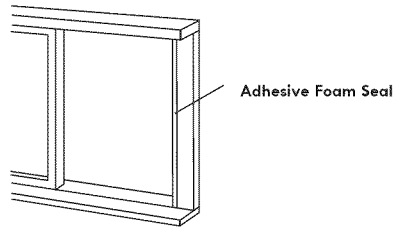

Fig.12

3. Cut another length of adhesive foam seal and attach it to the window sash (see Fig. 13). Close the window sash securely onto the window slider (see Fig. 14).

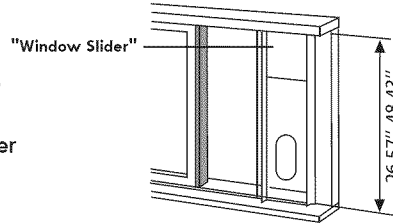

Fig.13

4. Cut the non-adhesive thick foam seal to window height and insert into the open gap between the inner window and outer window sash (see Fig. 15).

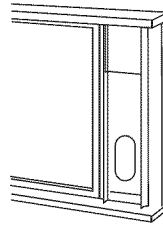

Fig.14



Fig.15

Exhaust hose installation

The exhaust hose and adaptor must be installed or not installed in accordance with the usage mode.

COOL or AUTO mode	Install
FAN or DEHUMIDIFY mode	Do not install

1. Screw adaptor B and adaptor I onto the exhaust hose as shown in Fig. 16a.
2. Align tabs of B adaptor with slots of air outlet and push down to secure in place (see Fig. 17).

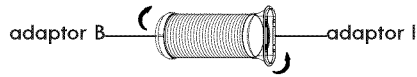

Fig.16a

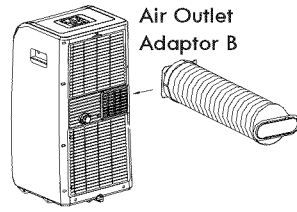

Fig.17

NOTE: The exhaust hose can be compressed or extended as needed, but optimum performance decreases at greater lengths.

IMPORTANT:
DO NOT BEND THE EXHAUST HOSE TOO SHARPLY (See Fig. 18a)

CONNECT THE HOSE SMOOTHLY (See Fig.18b)

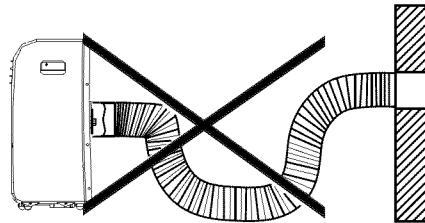

Fig.18a

⚠ Caution:

For the unit to exhaust properly, make sure that there is no obstacle within 20 inches of the window slider opening.

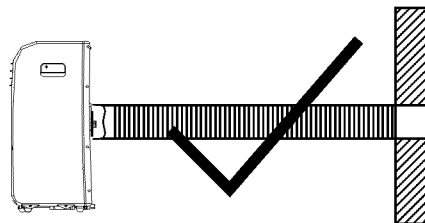

Fig.18b

Water drainage

1. For dehumidifying mode, pull the drain plug from the upper drain hole fitting. Push the open end of the supplied drain hose securely over the fitting. Place the adaptor end of the hose directly over a floor drain so that the water will flow into the drain (See Fig.19).

You may also screw the end of a garden hose over the threaded fitting of the upper drain hole.

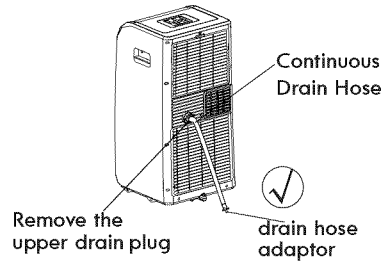

Fig.19

NOTE: Make sure the hose is securely fitted to the upper drain so there are no leaks. Direct the hose toward the floor drain so that there are no kinks to stop or interfere with water flow. Make sure that the end of the hose is positioned so that water flows into the floor drain.

2. If water in the bottom tray reaches a predetermined level, the unit beeps 8 times and P1 appears in the display. Air conditioning or dehumidifying will immediately stop; however, the fan will continue to operate.

Carefully move the unit to a drain location, and remove the bottom drain plug to drain the water from the bottom tray (See Fig.20).

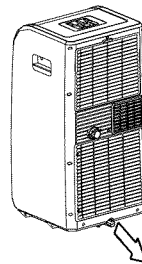

Fig.20

Bottom Drain Plug

NOTE: Be sure to reinstall the bottom drain plug before using the unit.

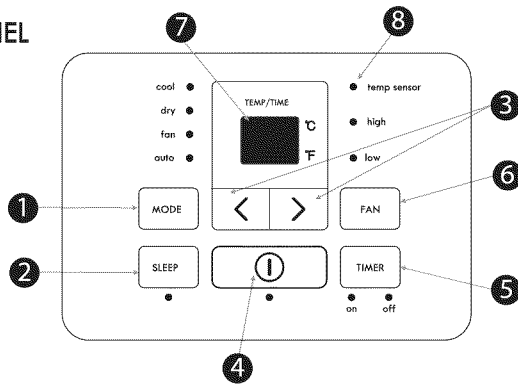

OPERATION

CONTROL PANEL

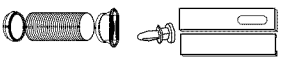

- 1 MODE button**
Press this button to select the operating mode in a sequence that advances from AUTO to COOL to DRY to FAN. An indicator light will illuminate for each mode setting.
- 2 SLEEP button**
Used to initiate the SLEEP operation.
- 3 UP (>) and DOWN (<) button**
Press to increase or decrease temperature settings in 2°F (1°C) increments from 62°F (17°C) to 88°F (30°C), or TIMER setting from 0 to 24 hrs.
NOTE: Temperature can be displayed in Fahrenheit or Celsius. To change from one to the other, press and hold the Up and Down buttons at the same time for 3 seconds.
- 4 POWER button with OPERATION indicator**
Power switch on/off.
- 5 TIMER button**
Used to initiate the AUTO ON start time and AUTO OFF stop time program, in conjunction with the < & > buttons. An indicator light will illuminate with each setting.
- 6 FAN button**
Press to select three different fan speed settings: LOW, HIGH, and AUTO. An indicator light will illuminate for each speed setting.
- 7 LED Display**
Shows the set temperature in °C or °F and the Auto-timer settings. While in DRY and FAN modes, the display shows the room temperature.
- 8 TEMP SENSOR feature**
NOTE: This feature can be activated from the remote control ONLY. The remote control serves as a remote thermostat allowing for precise temperature control at its location. To activate the TEMP SENSOR feature, point the remote control towards the unit and press the TEMP SENSOR button. The remote display shows the actual temperature at its location. The remote control will send this signal to the Air Conditioner at intervals of every 3 minutes until pressing the TEMP SENSOR button again.
If the unit does not receive the TEMP SENSOR signal during any 7 minute interval, the unit will beep to indicate the TEMP SENSOR mode has ended.

ACCESSORIES

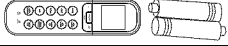
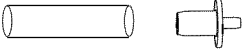
PART	PART NAME	QUANTITY
	Exhaust hose and Adaptor I (narrow mouth) and Adaptor B (round mouth), Window Slider and Screw	1 set
	Foam Seals: 2 Adhesive, 1 Non-adhesive	3pc
	Remote Control and Battery	1pc
	Drain hose and drain hose adaptor	1pc

ERROR CODES AND PROTECTION CODE:

E1- Room temperature sensor error - Unplug the unit and plug it back in. If error repeats, arrange for service.

E2- Evaporator temperature sensor error - Unplug the unit and plug it back in. If error repeats, arrange for service.

E3- Condenser temperature sensor error - Unplug the unit and plug it back in. If error repeats, arrange for service.

E4- Display panel communication error - Unplug the unit and plug it back in. If error repeats, arrange for service.

P1- Bottom tray is full - Connect the drain hose and drain the collected water away. If error repeats, arrange for service.

OPERATING INSTRUCTIONS

COOL operation

1. Press the "MODE" button until the "COOL" indicator light comes on.
2. Press the "+" or "-" buttons to select your desired room temperature.
The temperature can be set within a range of 62°F (17°C) - 88°F (30°C).
3. Press the "FAN" button to choose the fan speed.

AUTO operation

1. When Air Conditioner is in AUTO mode, it will automatically choose cooling or fan-only operation based on the set temperature point.
2. In AUTO mode you cannot manually set the fan speed.

FAN operation

1. Press the "MODE" button until the "FAN " indicator light comes on.
2. Press the "FAN " button to choose the fan speed. The temperature cannot be adjusted.
3. In FAN mode, detach the exhaust hose from the air outlet in the back of the unit.

TIMER operation

1. With the unit on, press the Timer button. The Off light will indicate the Auto Stop function may be programmed. Within 5 seconds press the UP or DOWN buttons to select a period of time after which operation will stop. Press the Timer button twice. The On light will indicate the Auto Start function may be programmed. Within 5 seconds press the UP or DOWN buttons to select a period of time after which operation will resume.
2. With the unit off, press the Timer button. The On light will indicate the Auto Start function may be programmed. Within 5 seconds press the UP or DOWN buttons to select a period of time after which operation will start. Press the Timer button twice. The Off light will indicate the Auto Stop function may be programmed. Within 5 seconds press the UP or DOWN button to select a period of time after which operation will stop.
3. NOTES:
 - Auto time changes in 0.5 hour increments up to 10 hours, then in 1 hour increments up to 24 hours.
 - Turning the unit ON or OFF or adjusting both timer settings to 0.0 will cancel the Auto Start/Stop timer program.
 - When a malfunction (E1, E2, E3 or E4) occurs, Auto Start/Stop will also be cancelled.

SLEEP operation

Press the SLEEP button for the selected temperature setting to increase to 2° F (1° C) warmer after 30 minutes, and another 2° F (1° C) warmer after another 30 minutes. The warmer temperature will be maintained for 7 hours, at which time the unit will return to the originally selected temperature.

NOTE: The SLEEP feature is not available in the FAN or DRY mode.

OTHER FEATURES

Auto-Restart

If there is a power failure, the unit will return to the same operating condition when the power is restored.

Wait 3 minutes before resuming operation

3 minute compressor delay - Any time the compressor stops running for any reason, such as when the humidity set point has been reached, it will not restart again for a minimum of 3 minutes. This is a safety design to prolong the life of the compressor.

Air flow direction adjustment

- The louver can be set to the desired position manually.
- Do not place any heavy objects or other loads on the louver. Doing so will cause damage to the unit.
- Ensure the louver is fully opened under heating operation.
- Keep the louver fully opened during operation.

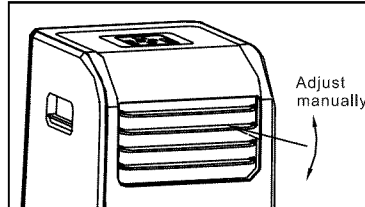

USING THE REMOTE CONTROL

Location of the remote control.

Use the remote control within a distance of 26 ft (8m) from the appliance, pointing it towards the receiver. Reception is confirmed by a beep.

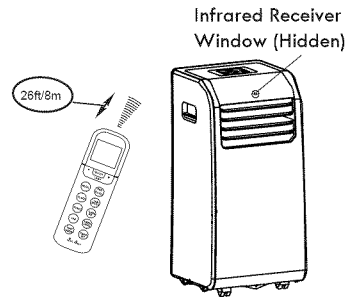

CAUTION:

- The Air Conditioner will not operate if curtains, doors or other materials block the signals from the remote control to the unit receiver.
- Prevent any liquid from falling into the remote control. Do not expose the remote control to direct sunlight or heat.
- If the infrared signal receiver on the unit is exposed to direct sunlight, the Air Conditioner may not function properly. Use curtains to prevent the sunlight from falling on the receiver.
- If other electrical appliances react to the remote control, move the appliances out of the range of the remote control signal.

Replacing batteries

The remote control is powered by two AAA batteries.

1. Remove the battery compartment cover by pressing and sliding off.
2. Remove the old batteries and insert the new batteries, placing the (+) and (-) ends correctly.
3. Reattach the cover by sliding it back into position.

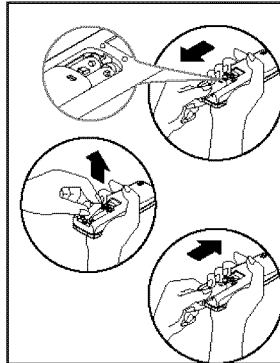

CAUTION:

- Do not mix old and new batteries or batteries of a different type.
- Do not leave the batteries in the remote control if it is not going to be used for 2 or 3 months.
- Do not throw batteries in household garbage; dispose of them at battery collection stations or special garbage sites.

Remote control Specifications

MODEL	RG36Y1/BGCEF2
Rated Voltage	3.0 V (Two AAA batteries)
Signal Receiving Range	26 ft (8m)
Environment	23°F (-5°C) - 140°F (60°C)

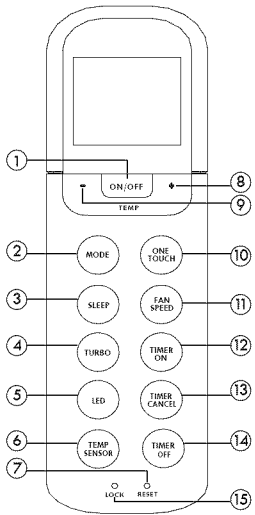

1 ON/OFF Button (/)

Turns the main unit on and off

2 MODE Button

Each time the button is pressed, the operating mode changes in this sequence: **AUTO → COOL → DRY → FAN**

3 SLEEP Button

Enables/Disables the SLEEP function. **NOTE:** If the unit is in SLEEP mode, it will be cancelled if the MODE, FAN SPEED or ON/OFF buttons are pressed.

4 TURBO Button

Activates the TURBO function. The fan will increase to maximum speed, in COOL mode only. There is no effect in other modes.

5 LED Button

Disable/Activate unit screen display.

6 TEMP SENSOR Button

The remote control serves as a remote thermostat allowing for temperature control at its location. To activate the TEMP SENSOR feature, point the remote control towards the unit and press the TEMP SENSOR button. The remote display shows the temperature at its location. The remote control will send this signal to the Air Conditioner at intervals of every 3 minutes until the TEMP SENSOR button is pressed again. If the unit does not receive the TEMP SENSOR signal during any 7 minute interval, the unit will beep to indicate the TEMP SENSOR mode has ended.

7 RESET Button

If the recessed RESET button is pressed, all current settings are cancelled and the control will return to the initial settings.

8 UP Button (/)

Push this button to increase the setting temperature or to increase the hour during Timer setting.

9 DOWN Button (/)

Push this button to decrease the setting temperature or to decrease the hour during Timer setting.

10 ONE TOUCH Button

- Used to restore to a favorite setting or the previous settings.
- The first time the unit is connected to power, if the ONE TOUCH button is pressed, the unit will change to AUTO mode, set to 76°F, and the fan speed will be set to Auto.
- If this button is pushed when remote controller is on, the system will automatically revert back to the previous settings including operating mode, setting temperature, fan speed level and sleep feature (if activated), and it will transmit these settings to the unit to set it.
- If this button is pushed when remote controller is off, the system will automatically revert back to the previous settings including operating mode, setting temperature, fan speed level, but will disable the Sleep feature. The remote will not transmit the signals to the unit.

- If this button is pressed for more than 2 seconds, the system will automatically store the current operation settings including operating mode, setting temperature, fan speed level and sleep feature (if activated). Then the next time the button is pressed, the remote will transmit these stored setting to the unit.

11 FAN SPEED Button

Used to select the fan speed in three steps:

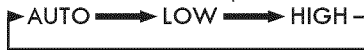

12 TIMER ON Button

Press this button to initiate the Auto-on time sequence. Each press will increase the auto-timed setting in 30 minutes increments. When the setting time displays 10H, each press will increase the auto-timed setting in 60 minutes increments. To cancel the auto-timed program, simply adjust the Auto-on time all the way back to 0.0.

13 TIMER CANCEL Button

Press this button to cancel the auto-timed program. NOTE: If the unit is running in timer mode, when you press this button, the function will be cancelled, and the unit will turn off.

14 TIMER OFF Button

Press this button to initiate the auto-off time sequence. Each press will increase the auto-timed setting in 30 minutes increments. When the setting time displays 10H, each press will increase the auto-timed setting in 60 minutes increments. To cancel the auto-timed program, simply adjust the auto-off time to 0.0

15 LOCK Button

When you press the recessed LOCK button, all current settings are locked in and the remote controller does not accept any operation except that of the LOCK button. Press again to cancel the LOCK mode.

INDICATORS ON LCD

Transmission Indicator

This transmission indicator lights when remote controller transmits signals to the indoor unit.

Mode display

Displays the current operation mode. Including auto(↻), cool(❄️), dry(☂️), fan(🏠) and back to auto(↻).

Temp./Timer display

Displays the temperature setting 62°F~88°F (17°C~30°C). When you set the operating mode to FAN, no temperature setting is displayed. And if in the TIMER mode, shows the ON and OFF settings of the TIMER.

Fan speed display

Displays the selected fan speed, AUTO(no display) and two fan speed levels "■" (LOW) "▮" (HIGH) can be indicated. The fan speed is AUTO when the operating mode is either AUTO or DRY.

ON/OFF display

Displayed by pressing the ON/OFF button. Press the ON/OFF button again to remove.

Lock Display

Displayed when LOCK mode is activated.

Follow me/TEMP SENSOR Display

Displayed when TEMP SENSOR function is activated.

Sleep Display

Displayed under sleeping operation. Press the SLEEP button again to remove.

Note:

All indicators shown in the figure are for the purpose of clear presentation. But during the actual operation only the relative functional signs are shown on the display window.

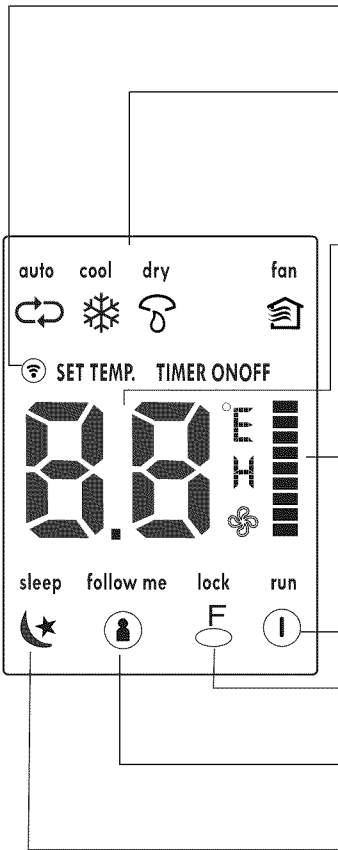

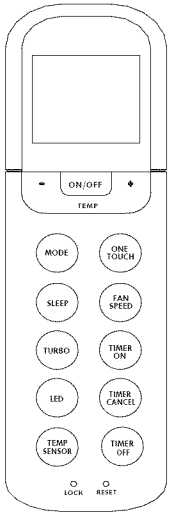

HOW TO USE THE BUTTONS

AUTO OPERATION

Ensure the unit is plugged in and power is available. The OPERATION indicator on the display panel of the main unit will be illuminated.

1. Press the MODE button to select Auto.
2. Press the UP/DOWN button to set the desired temperature. The temperature can be set within a range of 62°F ~ 88°F (17°C ~ 30°C) in 2°F (1°C) increments.
3. Press the ON/OFF button to start the Air Conditioner.

NOTE

1. In Auto mode, the Air Conditioner will logically choose a mode of Cooling, Fan, or Dry, by sensing the difference between the actual ambient room temperature and the setting temperature on the remote controller.
2. In Auto mode, you cannot switch the fan speed. It will be automatically controlled.
3. If the Auto mode is not comfortable for you, the desired mode can be selected manually.

COOLING/FAN OPERATION

Ensure the unit is plugged in and power is available.

1. Press the MODE button to select COOL or FAN mode.
2. Press the UP/DOWN buttons to set the desired temperature (in COOL mode only). The temperature can be set within a range of 62°F ~ 88°F (17°C ~ 30°C) in 2°F (1°C) increments.
3. Press the FAN button to select the fan speed in three steps- Auto, Low, or High.
4. Press the ON/OFF button to start the Air Conditioner.

NOTE

In the FAN mode, the temperature setting is not displayed in the remote controller and you are not able to control the room temperature. In this case, only step 1, 3 and 4 may be performed.

DEHUMIDIFYING OPERATION

Ensure the unit is plugged in and power is available. The OPERATION indicator on the display panel of the indoor unit will be illuminated.

1. Press the MODE button to select DRY mode.
2. Press the ON/OFF button to start the Air Conditioner in Dry mode.

NOTE

In the Dehumidifying mode, you cannot switch the fan speed. It will be automatically controlled.

LED OPERATION

Pressing the LED button will disable or activate unit screen display.

TIMER OPERATION

Pressing the TIMER ON button will set the Auto-on time of the unit. Pressing the TIMER OFF button will set the Auto-off time of the unit.

TO SET THE AUTO-ON TIME:

1. Press the TIMER ON button. The remote controller shows TIMER ON, the last Auto-on setting time and the symbol "h" will be shown on the LCD display area. Now it is ready to set the Auto-on time to START the operation.
2. Push the TIMER ON button again to set desired Auto-on time. Each time you press the button, the time increases by half an hour between 0 and 10 hours, and by one hour between 10 and 24 hours.
3. After setting the TIMER ON, there will be a one second delay before the remote controller transmits the signal to the Air Conditioner. Then, after approximately another 2 seconds, the symbol "h" will disappear and the set temperature will re-appear on the LCD display window. The set temperature will not appear in FAN mode.

TO SET THE AUTO-OFF TIME

1. Press the TIMER OFF button. The remote controller shows TIMER OFF, the last Auto-off setting time and the symbol "h" will be shown on the LCD display area. Now it is ready to set the Auto-off time to STOP the operation.
2. Push the TIMER OFF button again to set desired Auto-off time. Each time you press the button, the time increases by half an hour between 0 and 10 hours, and by one hour between 10 and 24 hours.
3. After setting the TIMER OFF, there will be a one second delay before the remote controller transmits the signal to the Air Conditioner. Then after approximately another 2 seconds, the symbol "h" will disappear and the set temperature will re-appear on the LCD display window. The set temperature will not appear in FAN mode.

TO CANCEL AUTO TIME

1. Press the TIMER CANCEL button to cancel the auto time.

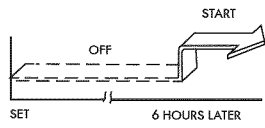
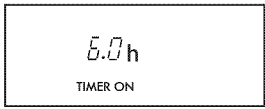

EXAMPLE OF TIMER SETTING TIMER ON (Auto-on Operation)

The TIMER ON feature is useful when you want the unit to turn on automatically, for example, before you return home. The Air Conditioner will automatically start operating at the set time. Example: To start the Air Conditioner in 6 hours.

1. Press the TIMER ON button. The last setting of starting operation time and the signal "h" will show on the display area.
2. Press the TIMER ON button to display "6:0h" on the TIMER ON display of the remote control.
3. Wait for about 3 seconds and the digital display area will show the temperature again. Now this function is activated.

TIMER OFF (Auto-off Operation)

The TIMER OFF feature is useful when you want the unit to turn off automatically after you go to bed. The Air Conditioner will stop automatically at the set time. Example: To stop the Air Conditioner in 10 hours.

1. Press the TIMER OFF button. The last setting of stopping operation time and the signal "h" will show on the display area.
2. Press the TIMER OFF button to display "10h" on the TIMER OFF display of the remote control.
3. Wait for about 3 seconds and the digital display area will show the temperature again. Now this function is activated.

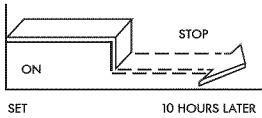
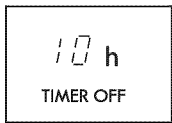

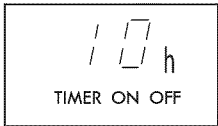

COMBINED TIMER (Setting both ON and OFF timers simultaneously)

TIMER OFF → TIMER ON
(On → Stop → Start operation)

This feature is useful when you want to stop the Air Conditioner after you go to bed, and start it again in the morning when you wake up or when you return home.

Example:

To stop the Air Conditioner 2 hours after setting and start it again 10 hours after setting.

1. Press the TIMER OFF button.
2. Press the TIMER OFF button again to display 2.0h on the TIMER OFF display.
3. Press the TIMER ON button.
4. Press the TIMER ON button again to display 10h on the TIMER ON display.
5. Wait for the remote control to display the setting temperature.

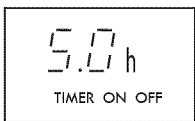
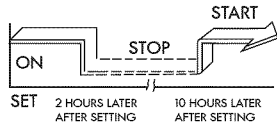

TIMER OFF → TIMER ON
(On → Stop → Stop operation)

This feature is useful when you want to start the Air Conditioner before you wake up and stop it after you leave the house.

Example: To start the Air Conditioner 2 hours after setting and stop it 5 hours after setting.

1. Press the TIMER ON button.
2. Press the TIMER ON button again to display 2.0h on the TIMER ON display.
3. Press the TIMER OFF button.
4. Press the TIMER OFF button again to display 5.0h on the TIMER OFF display.
5. Wait for the remote control to display the setting temperature.

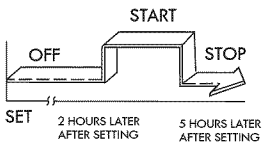

CAUTION

The timer setting (TIMER ON or TIMER OFF) that occurs first after the set time will be activated first.

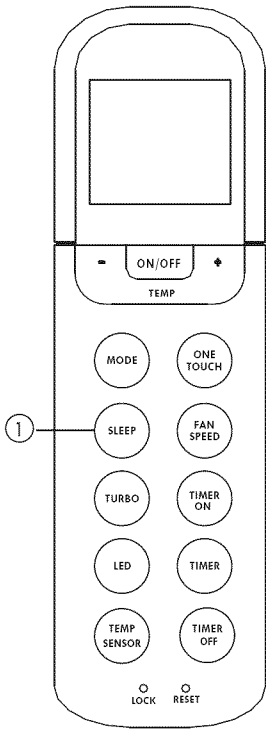

SLEEP OPERATION

Press the SLEEP button for the selected temperature setting to increase to 2° F (1° C) warmer after 30 minutes, and another 2° F (1° C) warmer after another 30 minutes.

The warmer temperature will be maintained for 7 hours at which time the unit will return to the originally selected temperature.

NOTE: The SLEEP feature is not available in the FAN or DRY mode.

CARE AND MAINTENANCE

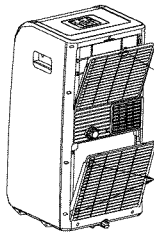

Upper filter
(take out)

Remove two
screws, then
take the lower
filter out.

Fig.21

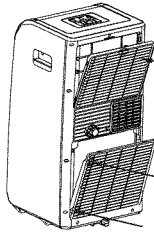

Upper filter
(install)

Install the lower
filter by using
two screws.

Fig.22

IMPORTANT:

1. Be sure to unplug the unit before cleaning or servicing.
2. Do not use gasoline, thinner or other chemicals to clean the unit.
3. Tap or hose washing may result in an electrical hazard when resuming operation of the unit.
4. If the power cord is damaged, discontinue unit use. Take unit to a Sears or other qualified service dealer for repair.

AIR FILTER

- Clean the air filter at least once every two weeks to prevent inferior fan operation because of dust.
- Removal
The unit has two filters. Pull open the upper filter grille, and raise the filter up and out of the unit (Fig. 21). Loosen and remove the screw on the lower filter grille, open the grille and remove the lower filter from the unit (Fig. 21).
- Cleaning
Wash the filters by immersing them gently in warm water (about 140°F/40°C) with a mild detergent. Rinse the filter and dry it in a shaded area.
- Mounting
Reinstall the air filters only after they are completely dry.

UNIT EXTERIOR

- Use a lint-free cloth soaked in mild detergent water to clean the exterior surfaces of the unit. Use another clean cloth to wipe the exterior surfaces dry.

UNIT IDLE FOR A LONG TIME

- Remove the plug from the upper drain hole fitting. Attach the open end of the supplied drain hose to the fitting, and place the other end so that water flows into a floor drain (See Fig. 19 on page 12).
- Carefully move the unit to a floor drain location, and remove the bottom drain plug to drain the water from the bottom tray (See Fig. 20 on page 12).
- Run the unit in FAN mode for half a day in a warm room to dry the inside of the unit and prevent mold formation.
- Turn off and unplug the unit, wrap the cord and bundle it with the supplied strap. Remove the batteries from the remote control.
- Clean and reinstall the air filters.

TROUBLESHOOTING

Before calling for service, review the chart below first yourself.

PROBLEM	CAUSE	SOLUTION
1. Unit does not Start when Pressing on/off Button	P1 appears in the display window When in COOL mode, room temperature is lower than the set temperature.	Drain the water in the bottom tray. Reset the temperature.
2. Not cool enough	The windows or doors in the room are not closed. There are heat sources inside the room. Exhaust air hose is not connected or blocked. Temperature setting is too high. Air filter is blocked by dust.	Make sure all the windows and doors are closed. Remove the heat sources if possible. Connect the hose and make sure it can function properly. Decrease the set temperature. Clean the air filter.
3. Unit noise or vibration	The ground is not level or not flat enough.	Place the unit on "a" flat, level ground if possible.
4. Gurgling sound	The sound comes from the flowing of the refrigerant inside the Air Conditioner.	It is normal.
5. Unit stops operating	The automatic over heat protection function. When the temperature at the air outlet exceed 158°F/70°C, the device will stop.	Switch on again after the unit has cool down.
6. RESET Button pops out on LCDI plug	Temporary Fault Condition	Press the reset button on the LCDI plug.

MASTER PROTECTION AGREEMENTS

- Congratulations on making a smart purchase. Your new Kenmore® product is designed and manufactured for years of dependable operation. But like all products, it may require preventive maintenance or repair from time to time. That's when having a Master Protection Agreement can save you money and aggravation.

The Master Protection Agreement also helps extend the life of your new product. Here's what the Agreement* includes:

- Parts and labor not just for repairing defects, but to help keep products operating properly under normal use. Our coverage goes well beyond the product warranty. No deductibles, no functional failure excluded from coverage— real protection.
- Expert service by a force of more than 10,000 authorized Sears service technicians, which means someone you can trust will be working on your product.
- Unlimited service calls and nationwide service, as often as you want us, whenever you want us.
- "No-lemon" guarantee – replacement of your covered product if four or more product failures occur within twelve months.
- Product replacement if your covered product can't be fixed.
- Annual Preventive Maintenance Check at your request – no extra charge.
- Fast help by phone – we call it Rapid Resolution – phone sup-port from a Sears representative on all products. Think of us as a "talking owner's manual."
- Power surge protection against electrical damage due to power fluctuations.
- \$250 Food Loss Protection annually for any food spoilage that is the result of mechanical failure of any covered refrigerator or freezer.
- Rental reimbursement if repair of your covered product takes longer than promised.
- 25% discount off the regular price of any non-covered repair service and related installed parts.

Once you purchase the Agreement, a simple phone call is all that it takes for you to schedule service. You can call anytime day or night, or schedule a service appointment online.

The Master Protection Agreement is a risk free purchase. If you can-cel for any reason during the product warranty period, we will provide a full refund. Or, a prorated refund anytime after the product warranty period expires. Purchase your Master Protection Agree-ment today!

- **Some limitations and exclusions apply. For prices and additional information in the U.S.A. call 1-800-827-6655.**
- **Coverage in Canada varies on some items. For full details call Sears Canada at 1-800-361-6665.**
- **Sears Installation Service**
For Sears professional installation of home appliances, garage door openers, water heaters, and other major home items, in the U.S.A. or Canada call 1-800-4-MY-HOME®.

Get it fixed, at your home or ours!

Your Home

For troubleshooting, product manuals and expert advice:



www.managemylife.com

For repair – **in your home** – of **all** major brand appliances, lawn and garden equipment, or heating and cooling systems, **no matter who made it, no matter who sold it!**

For the replacement parts, accessories and owner's manuals that you need to do-it-yourself.

For Sears professional installation of home appliances and items like garage door openers and water heaters.

1-800-4-MY-HOME® Call anytime, day or night
(1-800-469-4663) (U.S.A. and Canada)
www.sears.com www.sears.ca

Our Home

For repair of carry-in items like vacuums, lawn equipment, and electronics, call anytime for the location of the nearest **Sears Parts & Repair Service Center**

1-800-488-1222 (U.S.A.) **1-800-469-4663** (Canada)
www.sears.com www.sears.ca

To purchase a protection agreement on a product serviced by Sears:

1-800-827-6655 (U.S.A.) **1-800-361-6665** (Canada)

Para pedir servicio de reparación a domicilio, y para ordenar piezas:

1-888-SU-HOGAR®
(1-888-784-6427)
www.sears.com

Au Canada pour service en français:

1-800-LE-FOYER^{MC}
(1-800-533-6937)
www.sears.ca

The Sears logo, consisting of the word "sears" in a lowercase, serif font.

© Registered Trademark / TM Trademark of KCD IP, LLC in the United States, or Sears Brands, LLC in other countries

© Marca Registrada / TM Marca de Fábrica de KCD IP, LLC en Estados Unidos, o Sears Brands, LLC in otros países

^{MC} Marque de commerce / ^{MD} Marque déposée de Sears Brands, LLC