

This Owner's Manual is provided and hosted by [Appliance Factory Parts](#).

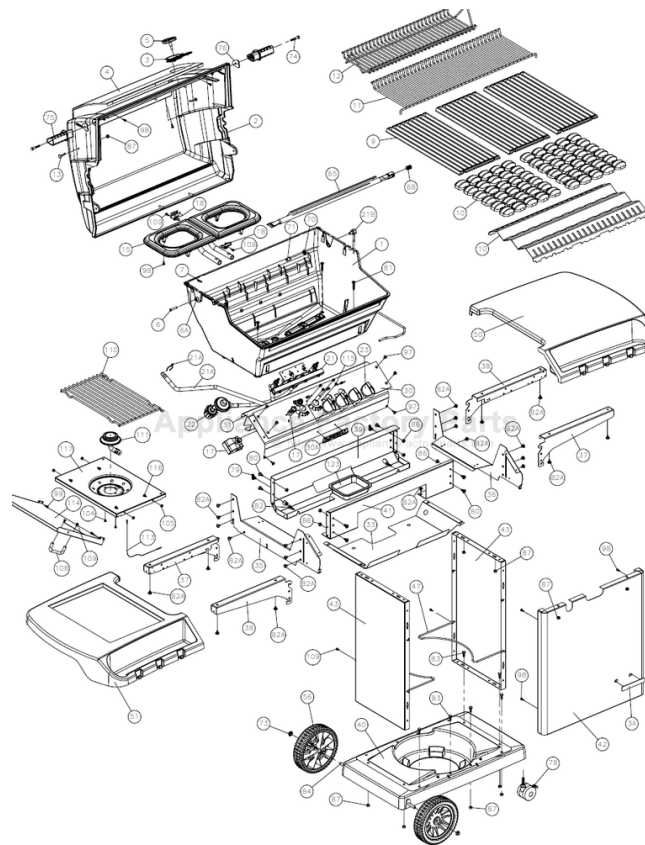

Broil King 960-94 Owner's Manual

[Shop genuine replacement parts for Broil King 960-94](#)



[Find Your Broil King Grill Parts - Select From 1350 Models](#)

----- Manual continues below part list -----

Available Replacement Parts for Broil King 960-94

03200	spark generator; Bmstr, DCS, Ducane
18434	INFINITY BURNER T501
10892-8NG	WHEEL 8 INCH GREY WALL
10225-T628	GRID FLAT WARMING RACK DELUXE+
10225-T627	GRID SWING BASKET IMPERIAL BLACK
10225-T528	GRID FLAT WARM RACK T50 PORC +
03230	spark generator; Ducane
18488	FLAV-R-WAVE - 50,000 BTU STAINLESS
11115	CI COOKING GRID - T626
10342-T301	IGNITOR ELECTRODE ASSEMBLY 8 BURNER 1993
10711-r562	SHELF LEFT C LG W/O BRACKET +
10222-T626	GRATE FLAV R CAST IMPERIAL +
18013	LARGE PROBE HEAT INDICATOR
10184-R19	TANK RETAINER-PEDESTAL-NEW
10225-T10	GRID PORCELAIN S/B
10393-K40	SIDE BURNER COVER 1.86
10081-BK630	NAMEPLATE HI BROIL KING BLACK ZINC
10240-15	HINGE PIN SIDE SHELF DROP DOWN
S21237	HINGE PIN SPACER
10110-91	TUBE R/B ASSY COMPR FITTING
10892-15	CASTER 2 1/2 INCH WHEEL KNURLED
S15171	AXLE PLTD 3/8x18 9/16 PED +
S21124	SCREW PHCP #8 X 12 +
PB20-60A	S/B LID HANDLE WAGON ENCLOSER+ W/SCREWS
10390-E10	BURNER SIDE 10BTU W/ELEC #8 +
10342-T14	WIRE ELECTRODE S/B FLAT/ROUND+
10393-R50	SIDE BURNER BODY 2002 +
10239-7	HANDLE GASKET TRIANGULAR 1/8
50416	SMALL DRIP PAN - 10 PACK
02342	control knob; universal

10342-246	IGNITOR ELECTRONIC TRIPLE +
10184-R80	RADIATION SHIELD RAW
S13005A	BURNER TUBULAR W/IGNITION
10696-127	R/B ORIFICE LP
10696-185	R/B ORIFICE NG 1.85MM
10909-T50	CASTING BOTTOM 52M 2002 +
10473-T50	CASTING TOP 52M
10081-BK611	NAMEPLATE REGAL ZINC DIE CAST
10184-K651	SUPPORT CASTING LEFT
Y-11797	BOLT SWING BASKET #D
10184-R581	SHELF SUPPORT LFT BLK(18 INCH)
10184-R591	SHELF SUPPORT RH BLK(18 INCH)
10472-k40	KNOB ROTARY IGNITOR #B
80012	regulator and hose READ ADD. INFO
10342-245	IGNITOR ELECTRONIC DUAL +
10958-E71	PEDESTAL RESIN BASE LRG +
11124	EXACT FIT CAST GRID
10111-K45	HOSE 3/8 INCH ASSEMBLY NG 10 FOOT +
Y-11990	NUT HEX BRASS 3/8 27 RB LINE

Broil King®

REDDI-BILT BARBECUES

ASSEMBLY MANUAL & PARTS LIST

MANUEL DE MONTAGE & LISTE DE PIÈCES

Broil King®

REGAL XL 20
960-24
960-27



Broil King®

REGAL XL 40
960-44
960-47

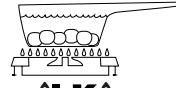

Broil King®

REGAL XL 70
960-74
960-77



Broil King®

REGAL XL 90
960-94
960-97

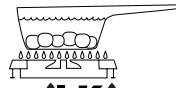

Broil King®

IMPERIAL 20
969-24
969-27



Broil King®

IMPERIAL 40
969-44
969-47

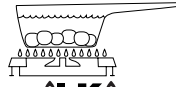

Broil King®

IMPERIAL 70
969-74
969-77



Broil King®

IMPERIAL 90
969-94
969-97

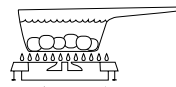

RETAIN FOR FUTURE REFERENCE

VEUILLEZ CONSERVER POUR REFERENCE ULTERIEURE

1-800-265-2150

Onward
MANUFACTURING COMPANY
LIMITED
585 KUMPF DRIVE
WATERLOO, ONTARIO, CANADA
N2V 1K3

SINCE 1906

info@omcbbq.com

10084-K64 Rev. J 12/04

1

(2)

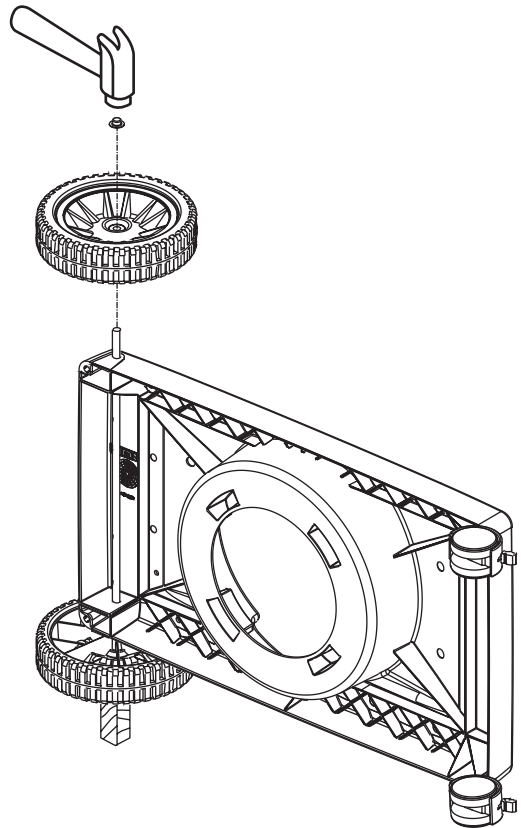
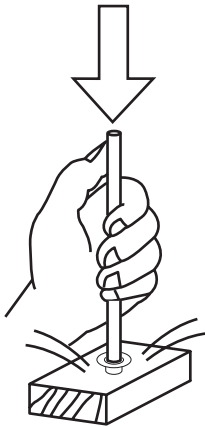
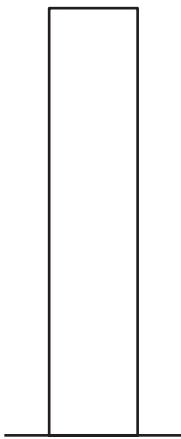
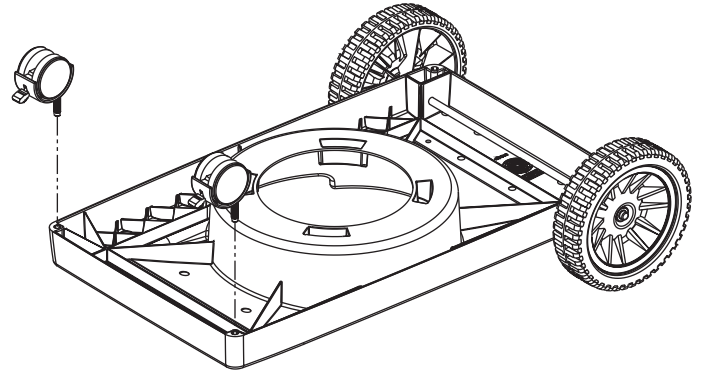
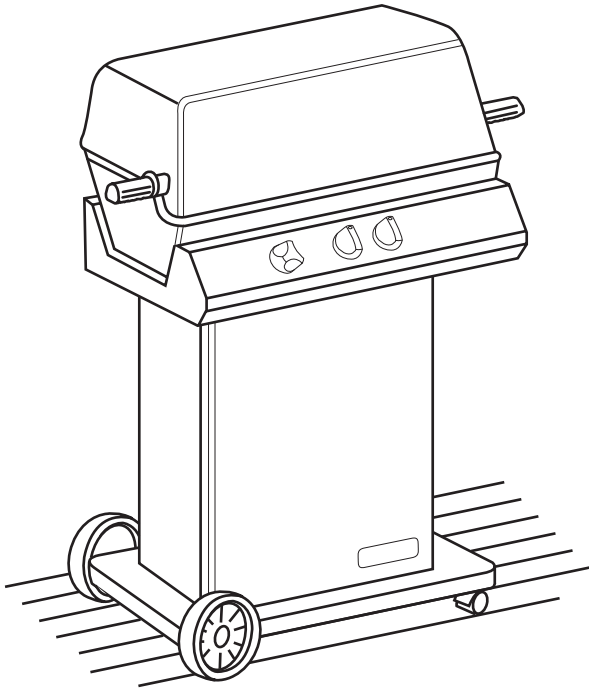

2

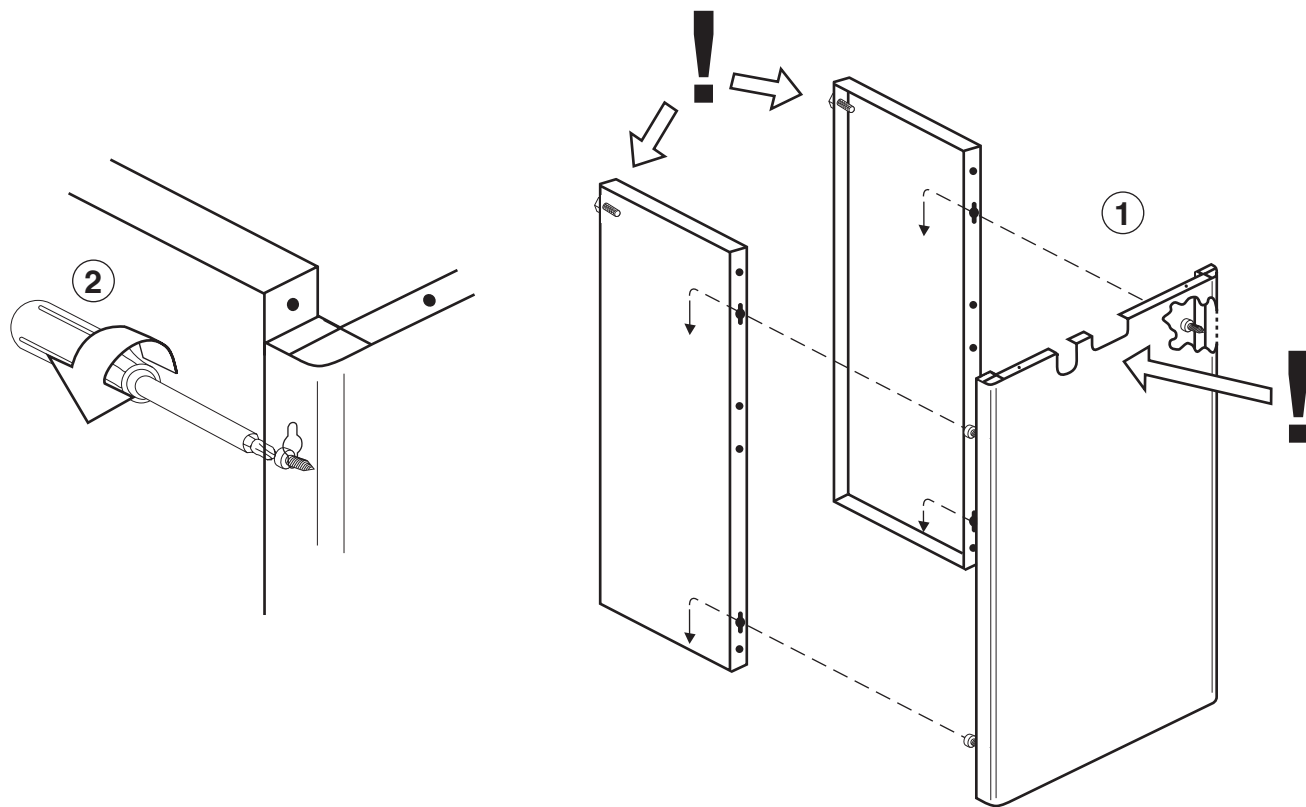

3

(6)

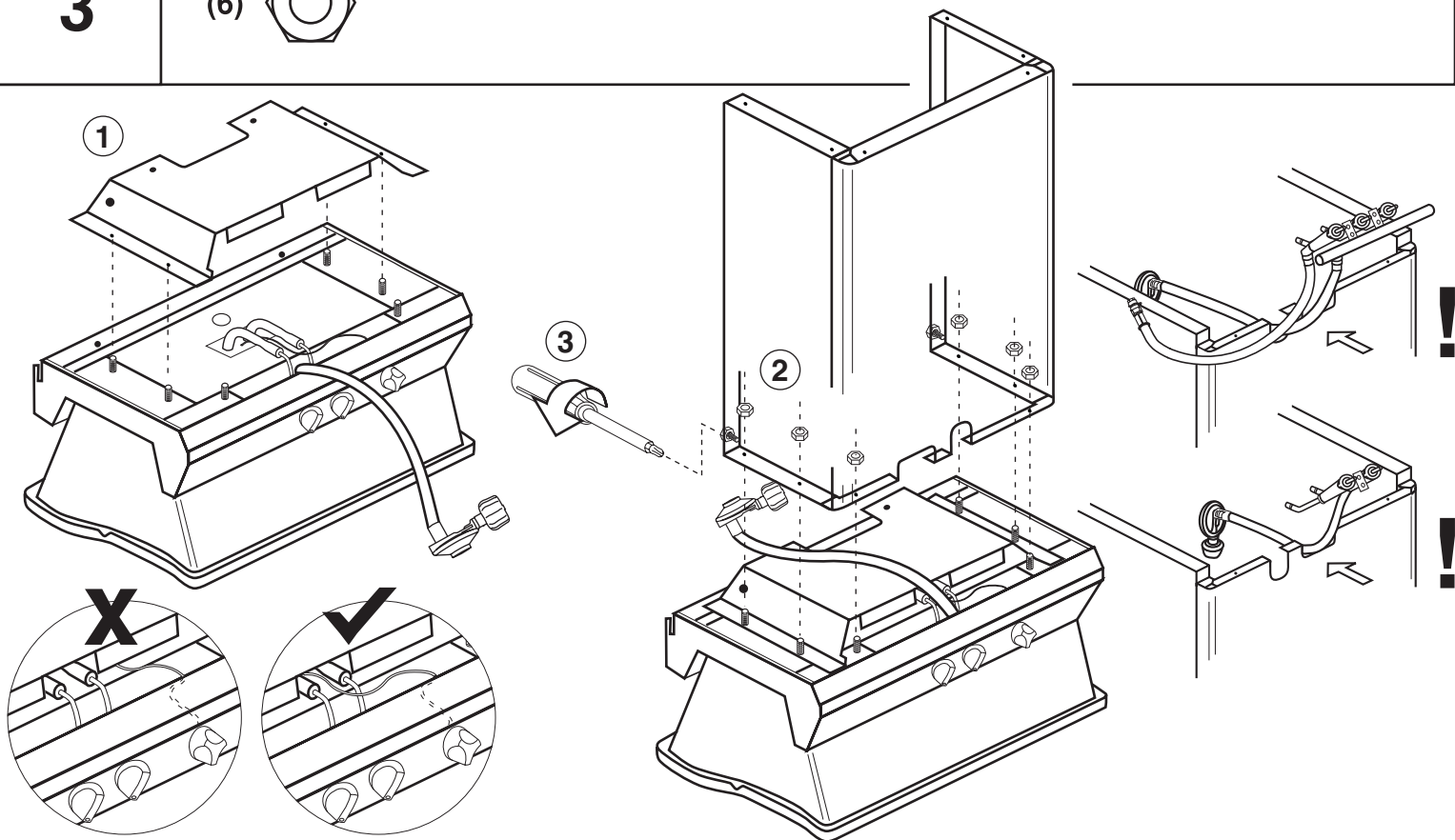

4

(8)

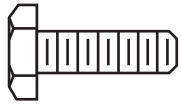

(8)

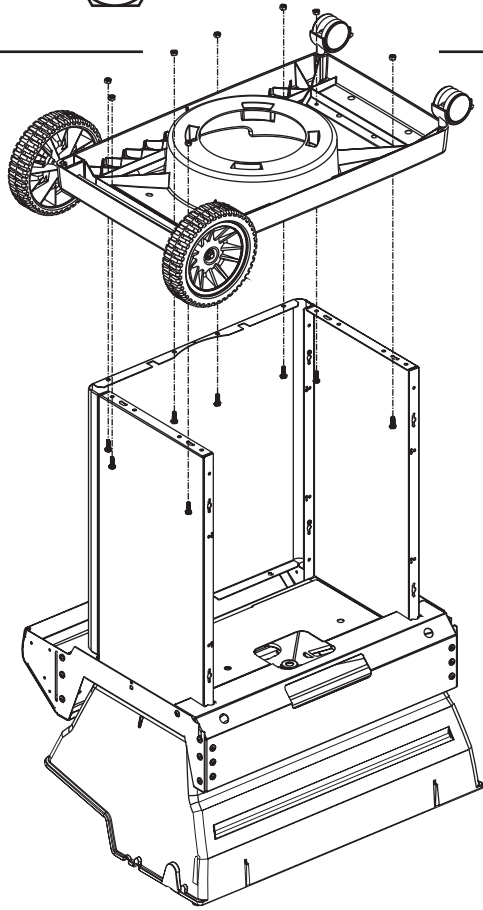

5

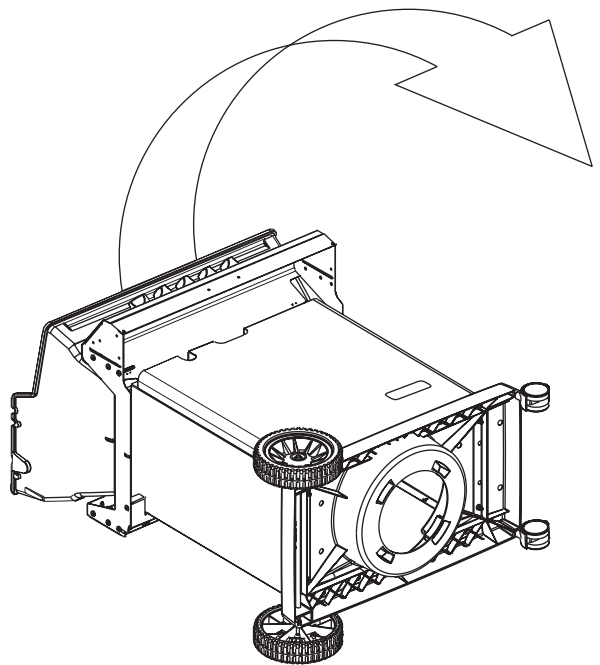
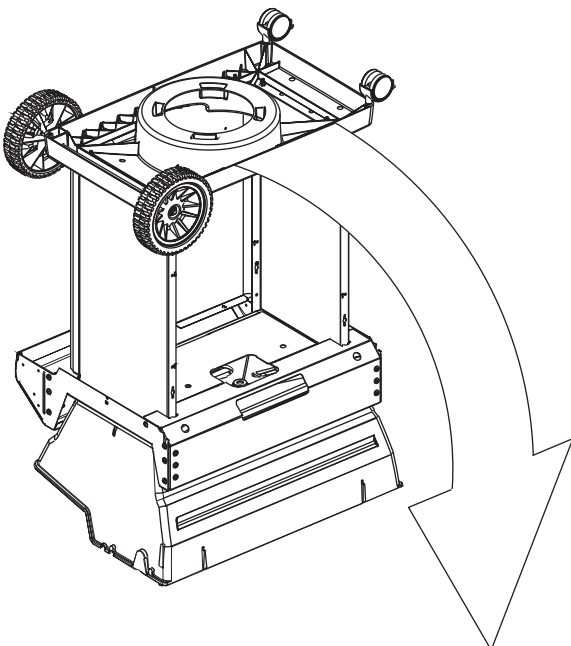

6

(2) 

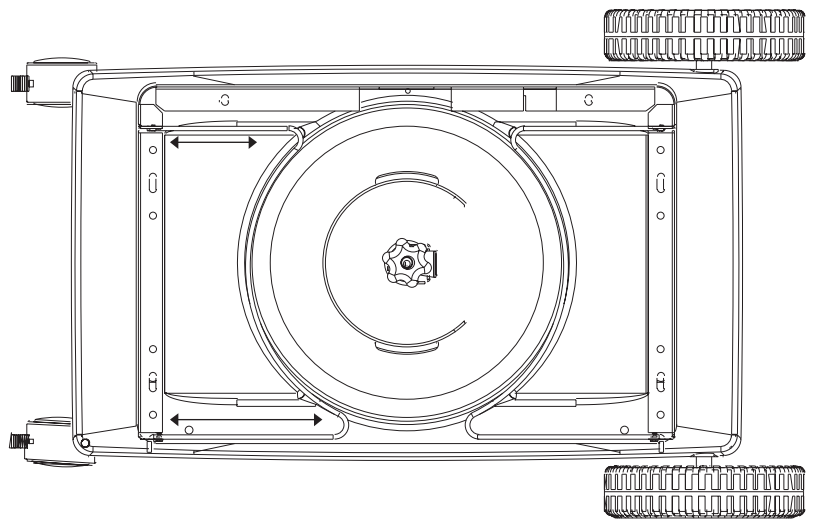
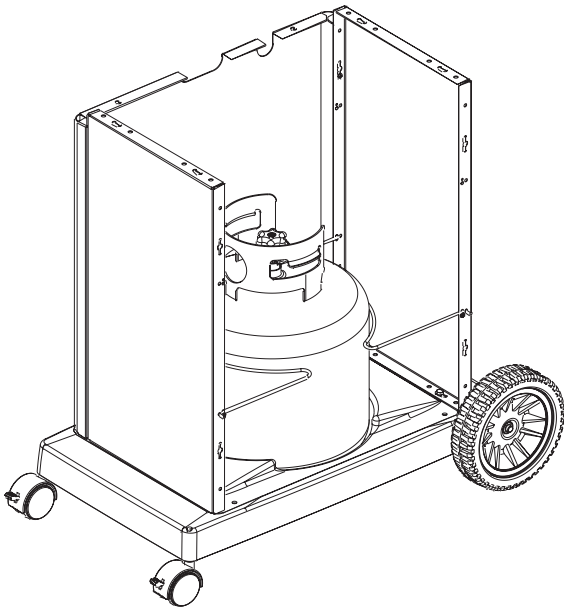
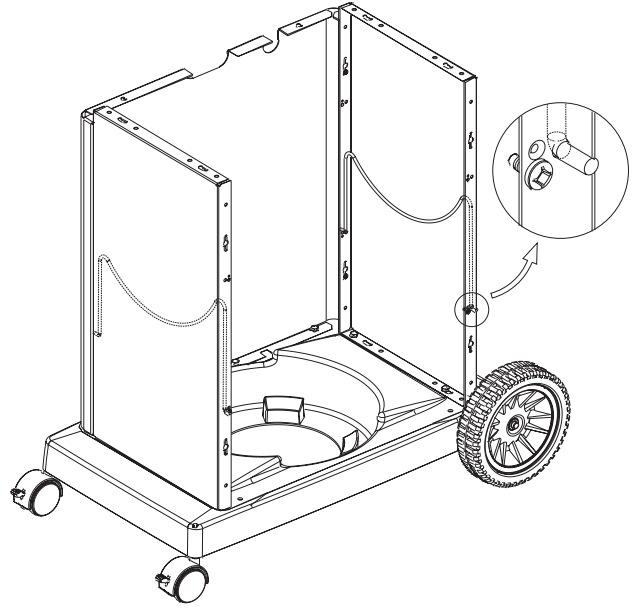
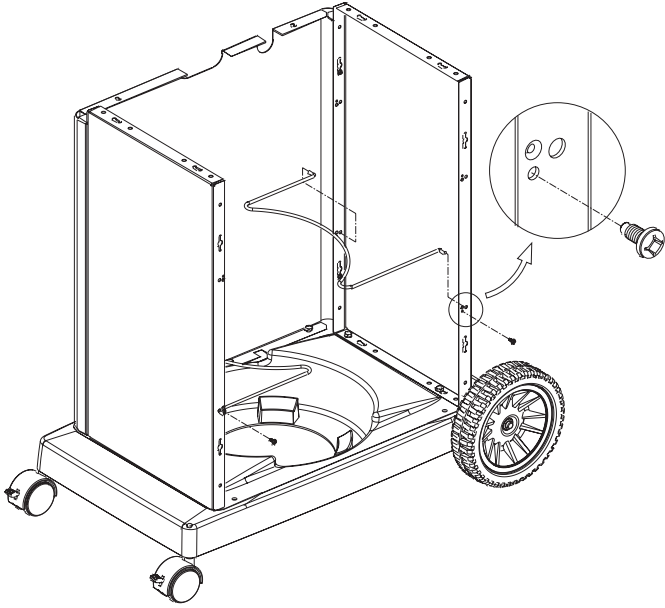

7

(2)



(2)

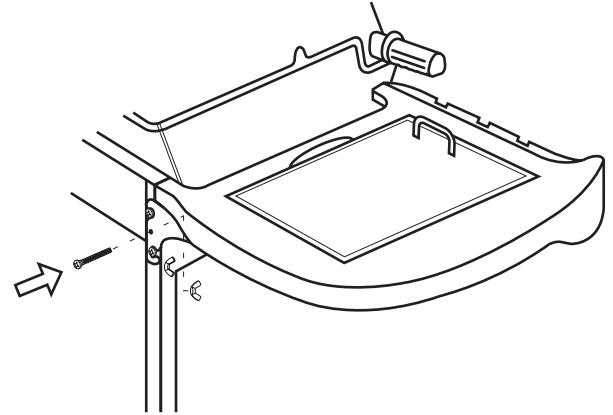
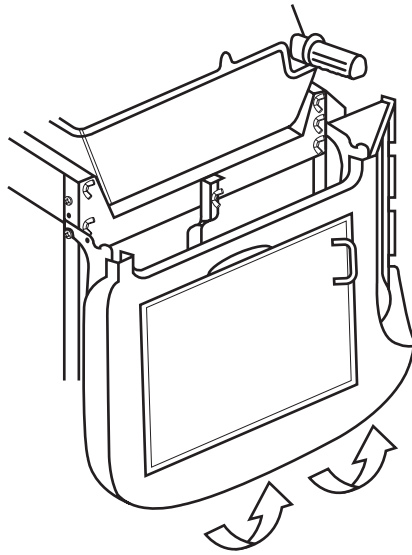
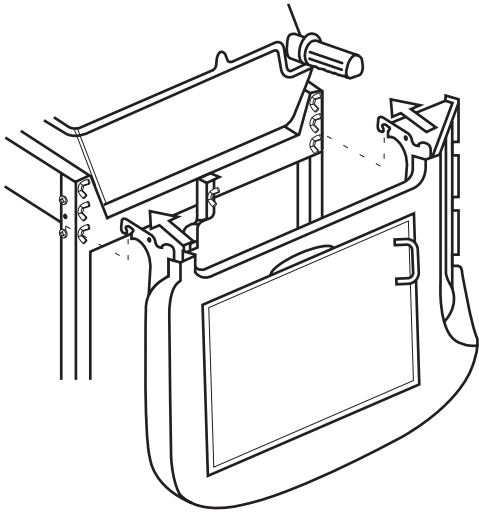
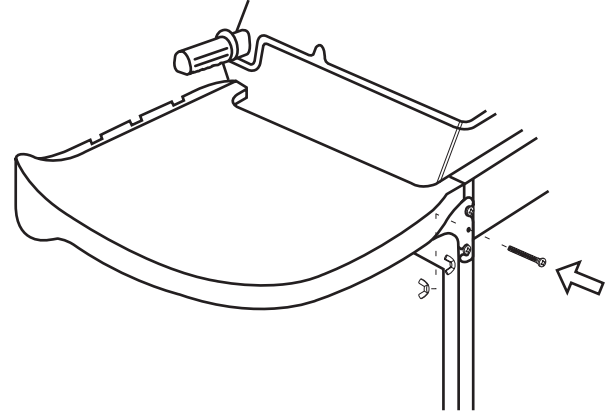
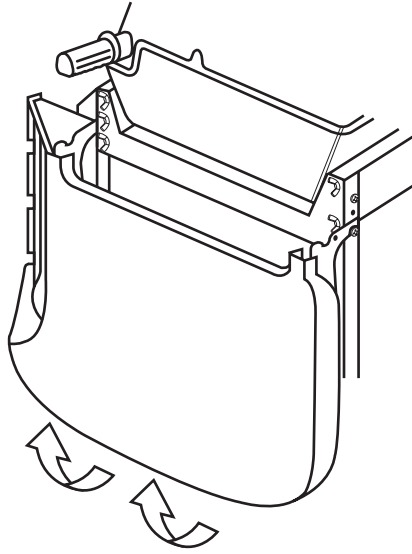
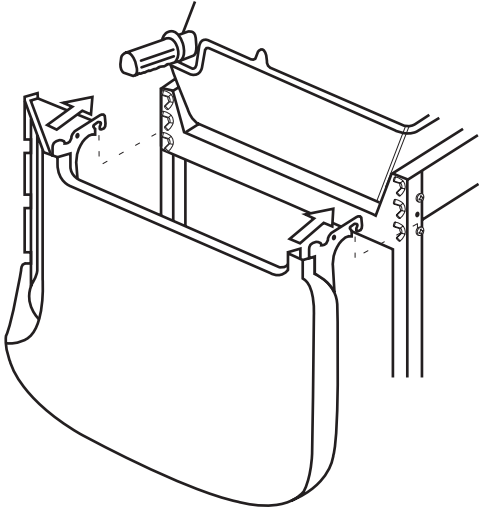

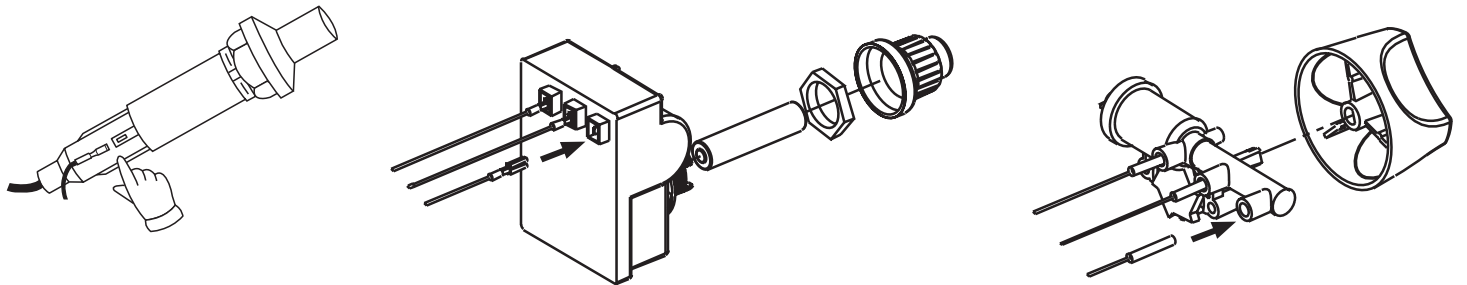
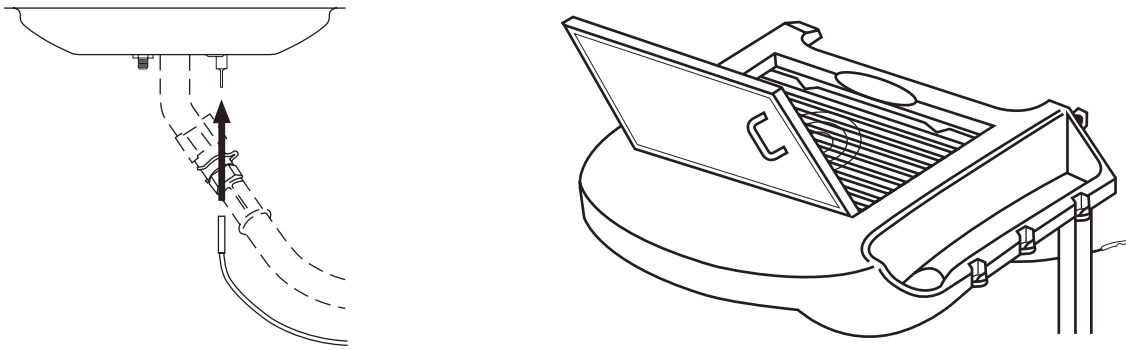
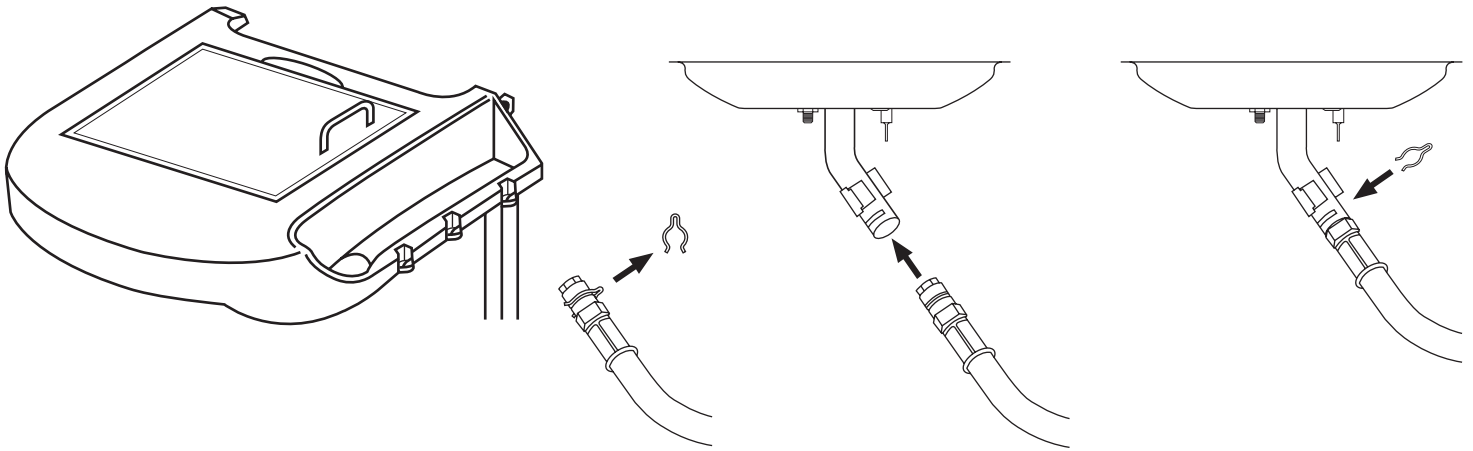

8

