

This Owner's Manual is provided and hosted by [Appliance Factory Parts](#).



Broil King 9133-87NZ Owner's Manual

[Shop genuine replacement parts for Broil King
9133-87NZ](#)



[Find Your Broil King Grill Parts - Select From 1350 Models](#)

----- Manual continues below part list -----

Available Replacement Parts for Broil King 9133-87NZ

18013	LARGE PROBE HEAT INDICATOR
S21124	SCREW PHCP #8 X 12 +
10390-E10	BURNER SIDE 10BTU W/ELEC #8 +
S15263	ROTISSERIE BUSHING
S15299	WASHER COUNTERWEIGHT ROTIS
S15270	ROTISSERIE COUNTERWEIGHT ASSY
S15271	ROTISSERIE HANDLE +
Y-12223	MAGNET SNAP IN - DOOR
Y-12222	MAGNET - DOOR
23000-271	SIDE BURNER BODY BASE
22009-901	GREASE PAN FORMED +
10342-E13	ELECTRODE W/WIRE
10342-T18	WIRE ELECTRODE S/B 600 +
24006-12A	HANDLE LID ASSY 625
S15260	SPIT ROD ROTISSERIE 750 45 INCH
27056-901	GREASE TRAY PORC FORMED 625
10240-20	DOOR PIN TOP
10240-19	DOOR PIN BOTTOM
27055-901	GREASE TRAY PORC FORMED 440 +
52045-92	FIREBOX 440 HEAT SHIELD REAR
52315-151	FIREBOX 440 HOOD PANEL PORC
52904-144	BURNER ASSY MAIN SINGLE TUBE + LP
18431	OEM FLAV R WAVE - BARON
52007-181	COOKING GRID 550 PORC BLK +
23000-251	COVER SIDE BURNER BLACK +
53139-98	GRID PORCELAIN S/B RAW *
52046-92	FIREBOX 550 HEAT SHIELD 5V AB
52316-151	FIREBOX 550 HOOD PANEL PORC
52006-991	WARMING RACK 550 PORC +
21036-991	GREASE RAIL 550/625

59006-074	CONTROL ASSEMBLY 5V W/SB RB LP
59006-077	CONTROL ASSY 5V S/B R/B NG
27906-354	REAR BURNER TUBULAR W/DEFLCTOR
10342-251	ELECTRONIC IGNITOR 5 POLE +
10342-T17	ELECTRODE WIRE REAR BURNER
10892-23	CASTER RUBBER 3 INCH W/PLATE
52015-903	COLLECTOR BOX ASSEMBLY 440
52016-903	COLLECTOR BOX ASSEMBLY 625
80012	regulator and hose READ ADD. INFO
50502	HEAVY DUTY MEAT FORKS
10111-K45	HOSE 3/8 INCH ASSEMBLY NG 10 FOOT +
24009-936	HANDLE RING
10472-K431	CONTRL KNOB RESIN LRG BLCK W/SS BA STRIP
21071-13	DOOR HANDLE 500 GPB
22001-168	CONTROL KNOB BEZEL SML
22002-268	CONTROL KNOB BEZEL LARGE
24005-12AB	LID-HANDLE BENT,
52005-991	WARMING RACK 440 PORC
21035-991	GREASE RAIL 440/500 SABLE BLK
59005-074	CONTROL ASSY 4V S/B R/B LP +
59005-077	VALVE ASSY 440 S/B R/B NG
27905-354	BURNER TUBE REAR 500 W/WINDSHIELD
53001-011A	SHELF ASSEMBLY 330/440 RHS + SS FASCIA
27249-904	GREASE SHIELD MODULAR, 6.5 x 6

Broil King®

REDDI-BILT BARBECUES

ASSEMBLY MANUAL & PARTS LIST

MANUEL DE MONTAGE & LISTE DE PIÈCES

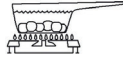

Broil King®

BARON 490
9123-84NZ
9123-87NZ

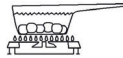

Broil King®

BARON 590
9133-84NZ
9133-87NZ

RETAIN FOR FUTURE REFERENCE

VEUILLEZ CONSERVER POUR REFERENCE ULTERIEURE

1-800-265-2150

info@omcbbq.com

Onward
SINCE 1906
MANUFACTURING COMPANY LIMITED
585 KUMPF DRIVE
WATERLOO, ONTARIO, CANADA
N2V 1K3

50084-S91 REV A 06/12

1

(16)

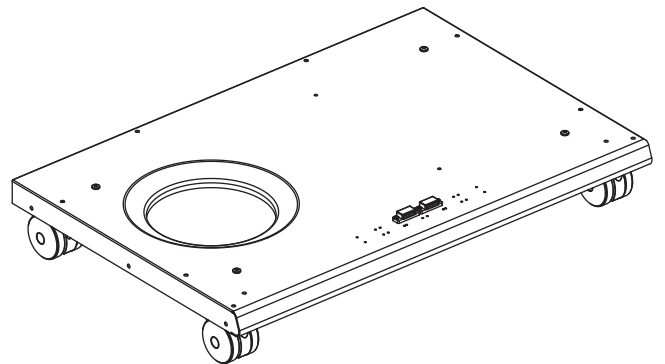
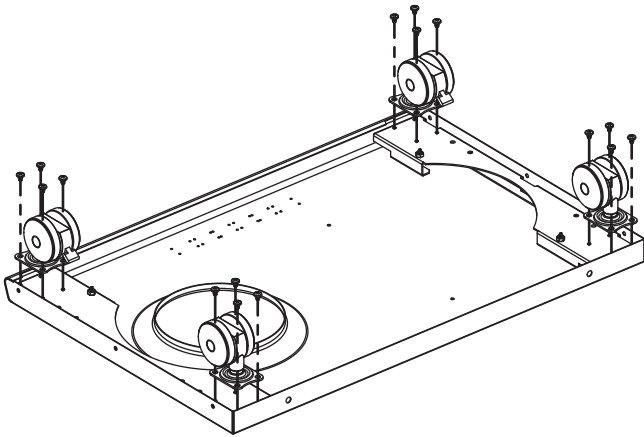
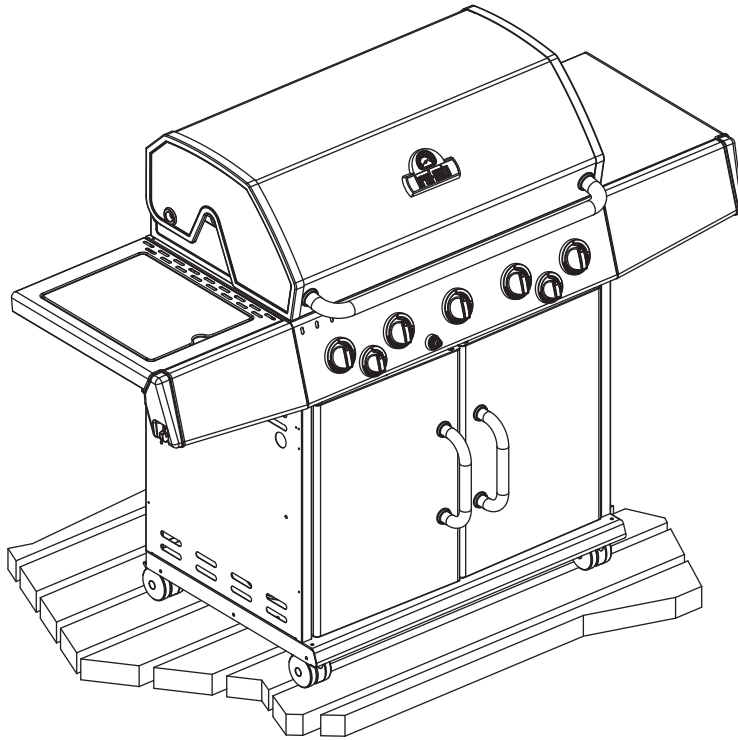
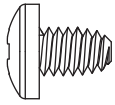

2

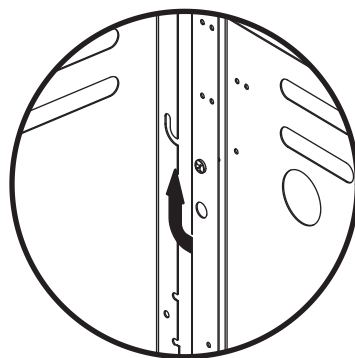
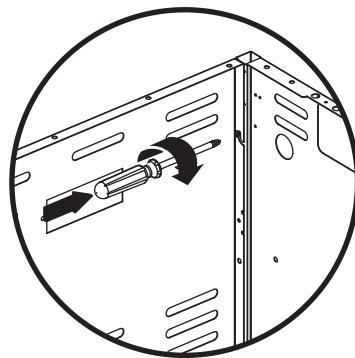
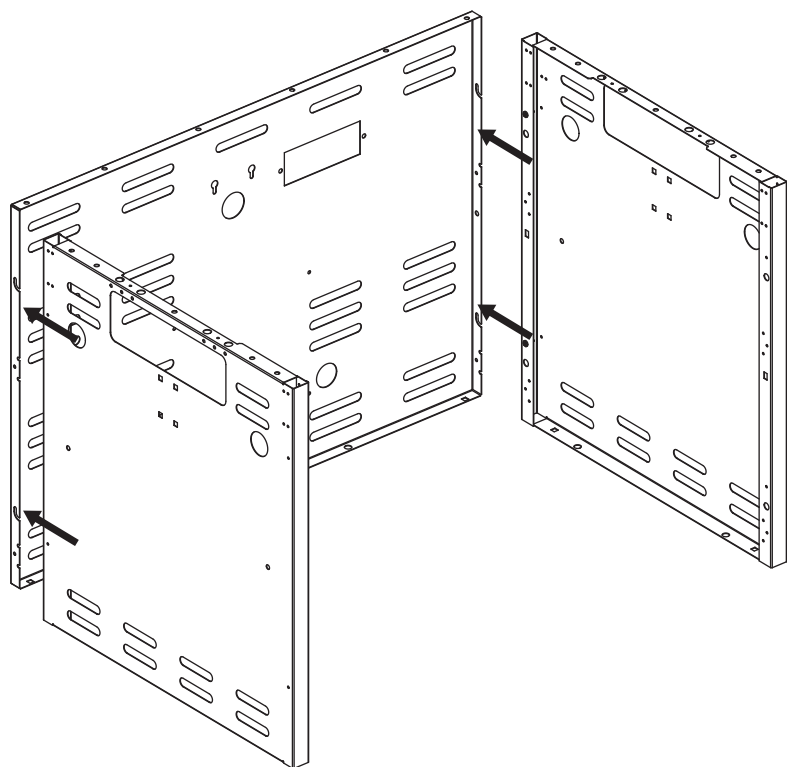

3

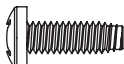
(4) 

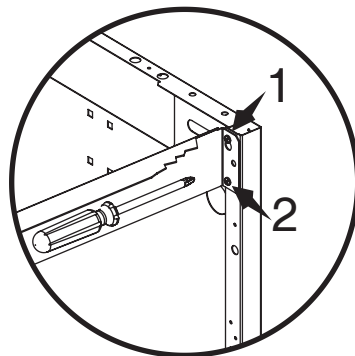
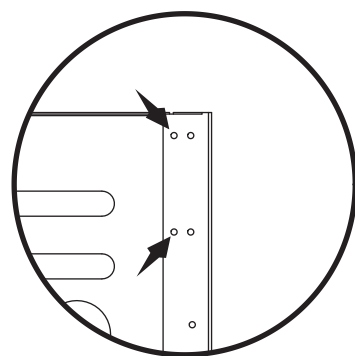
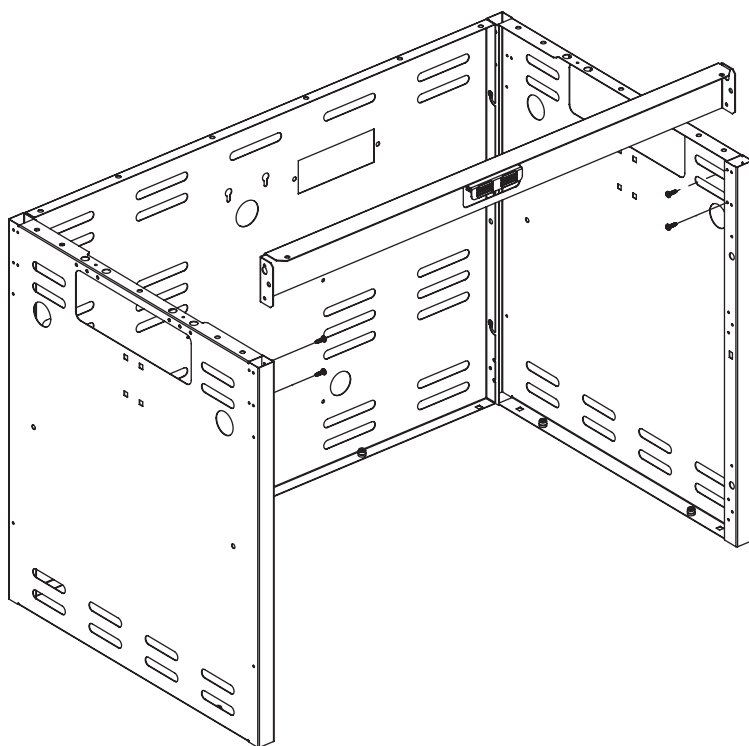

4

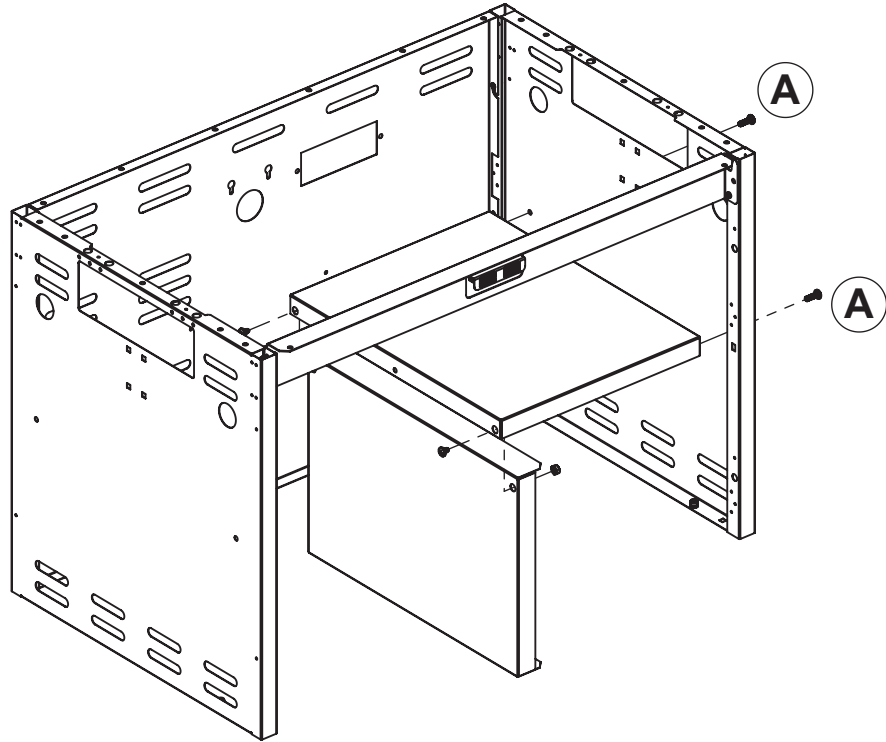
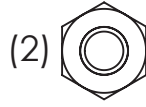
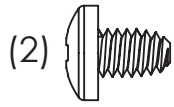
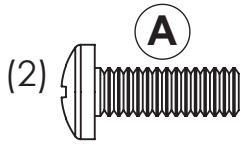

5

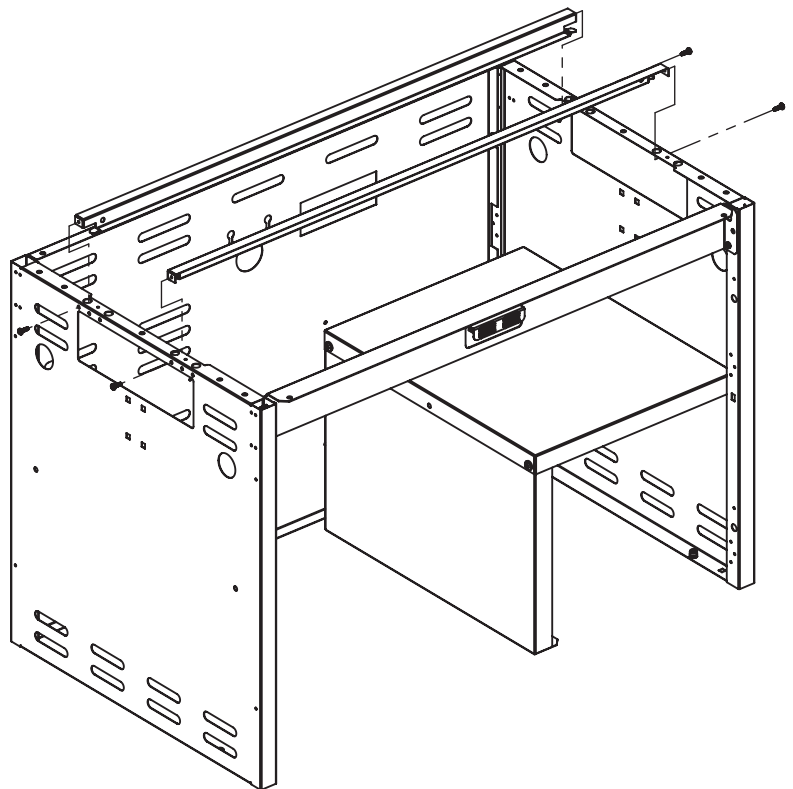
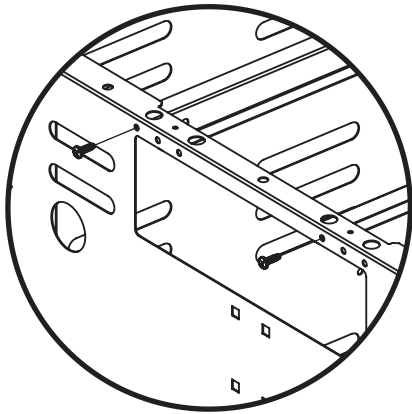

6

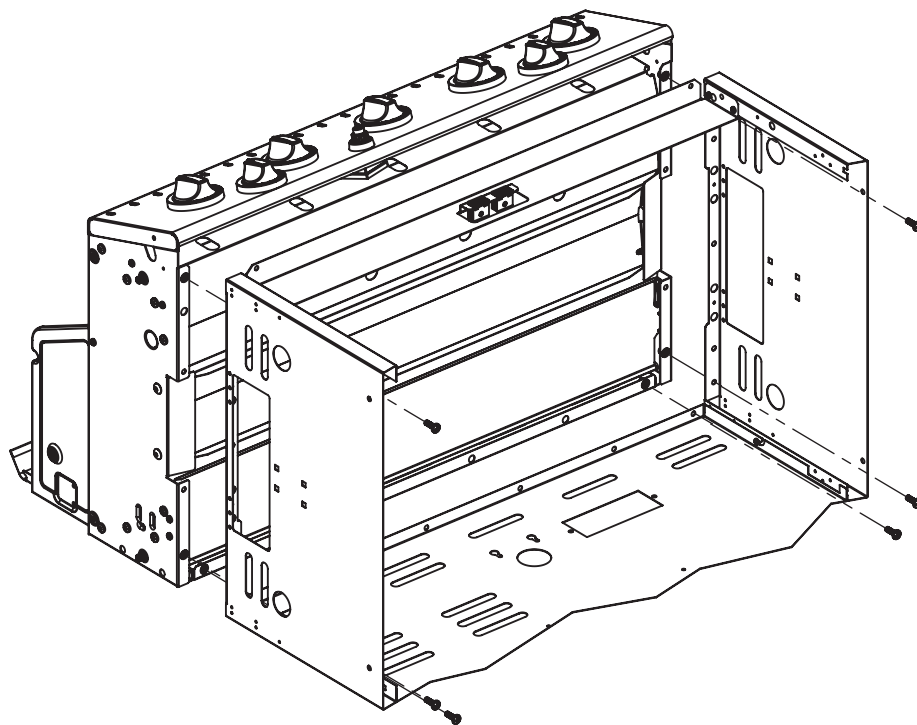
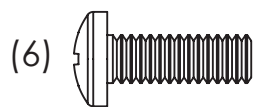

7

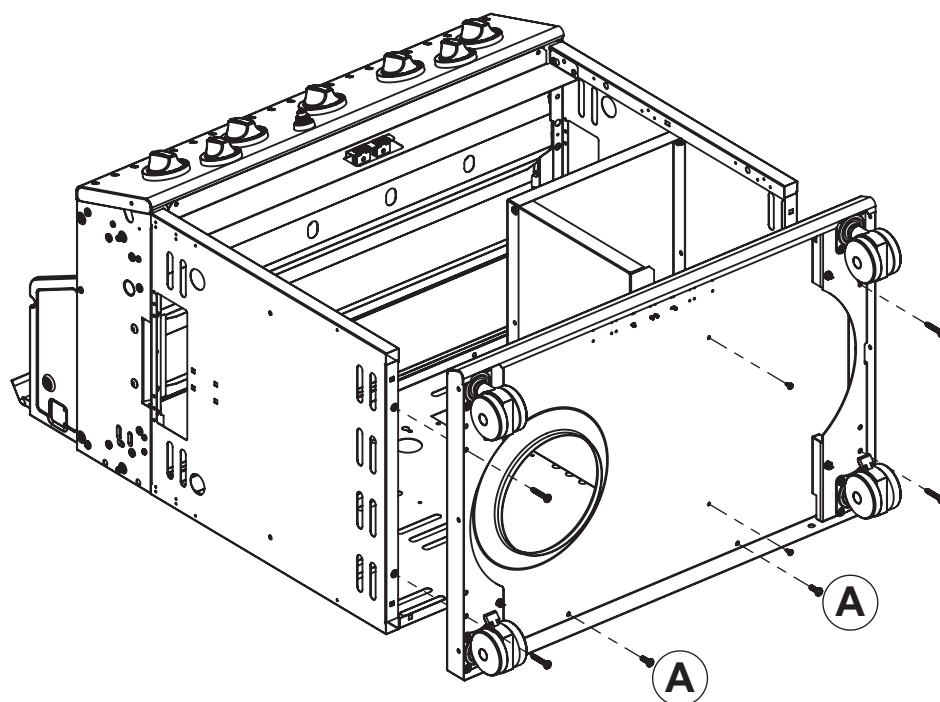
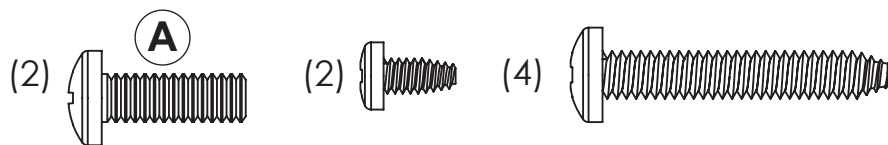

8

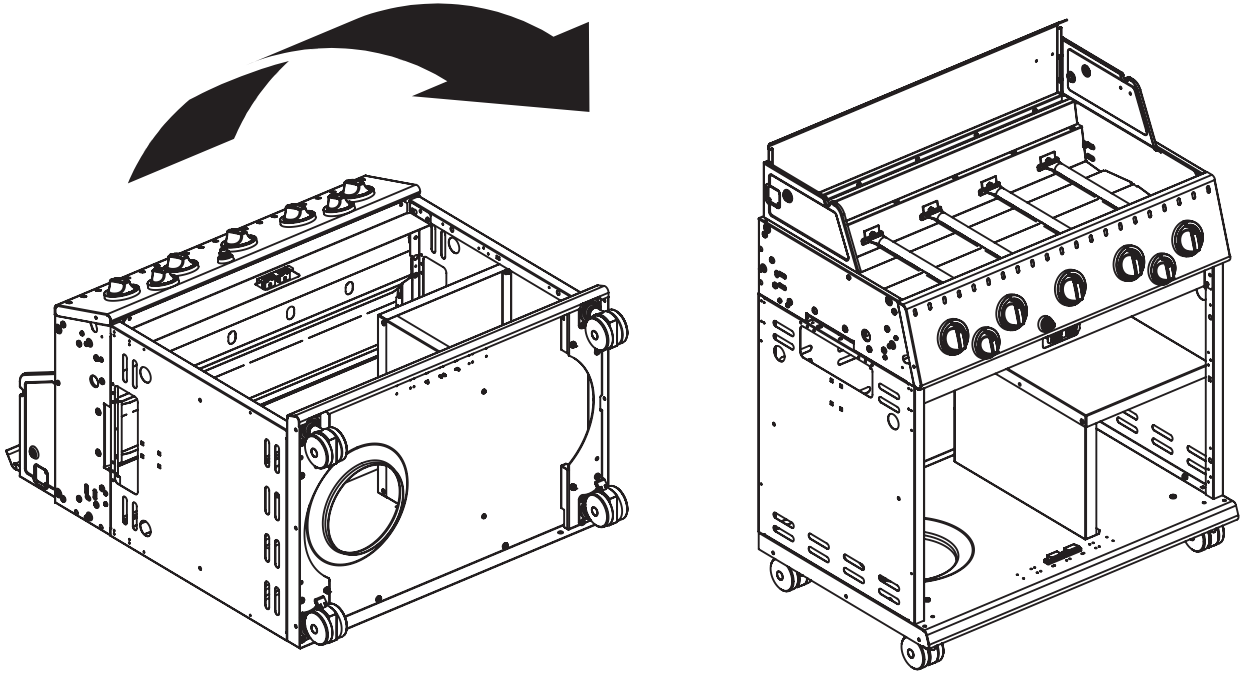

9

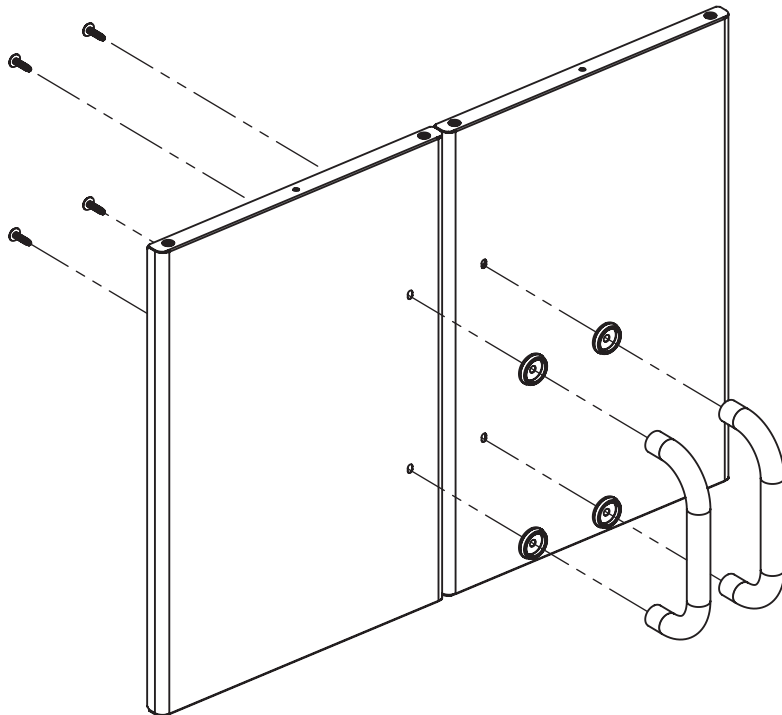
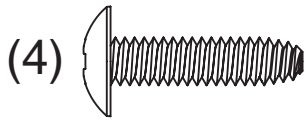

10

(2)

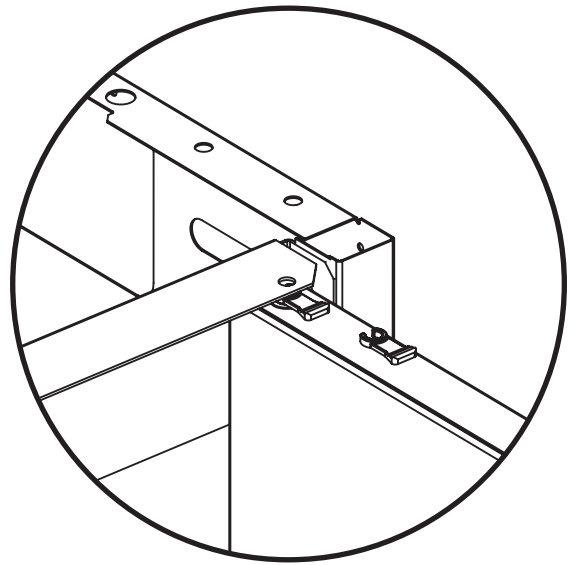
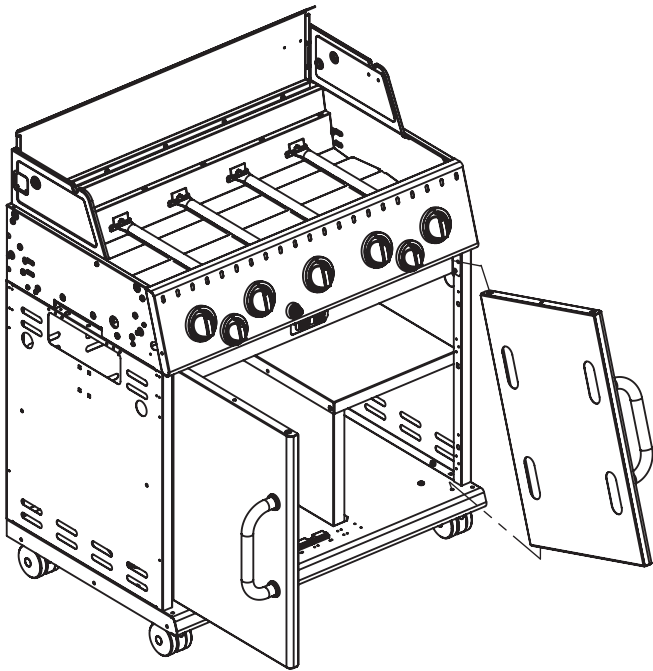
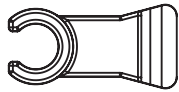

11

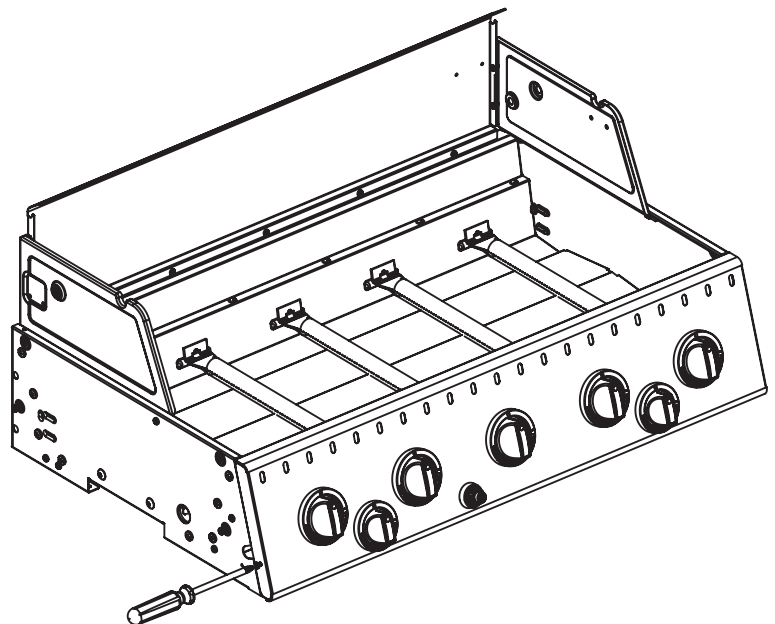
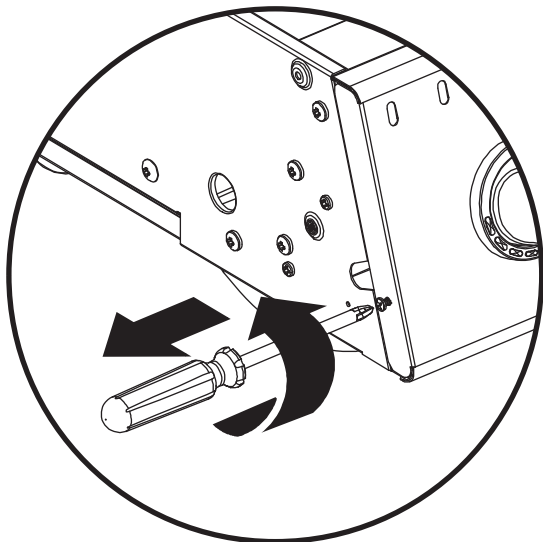

12

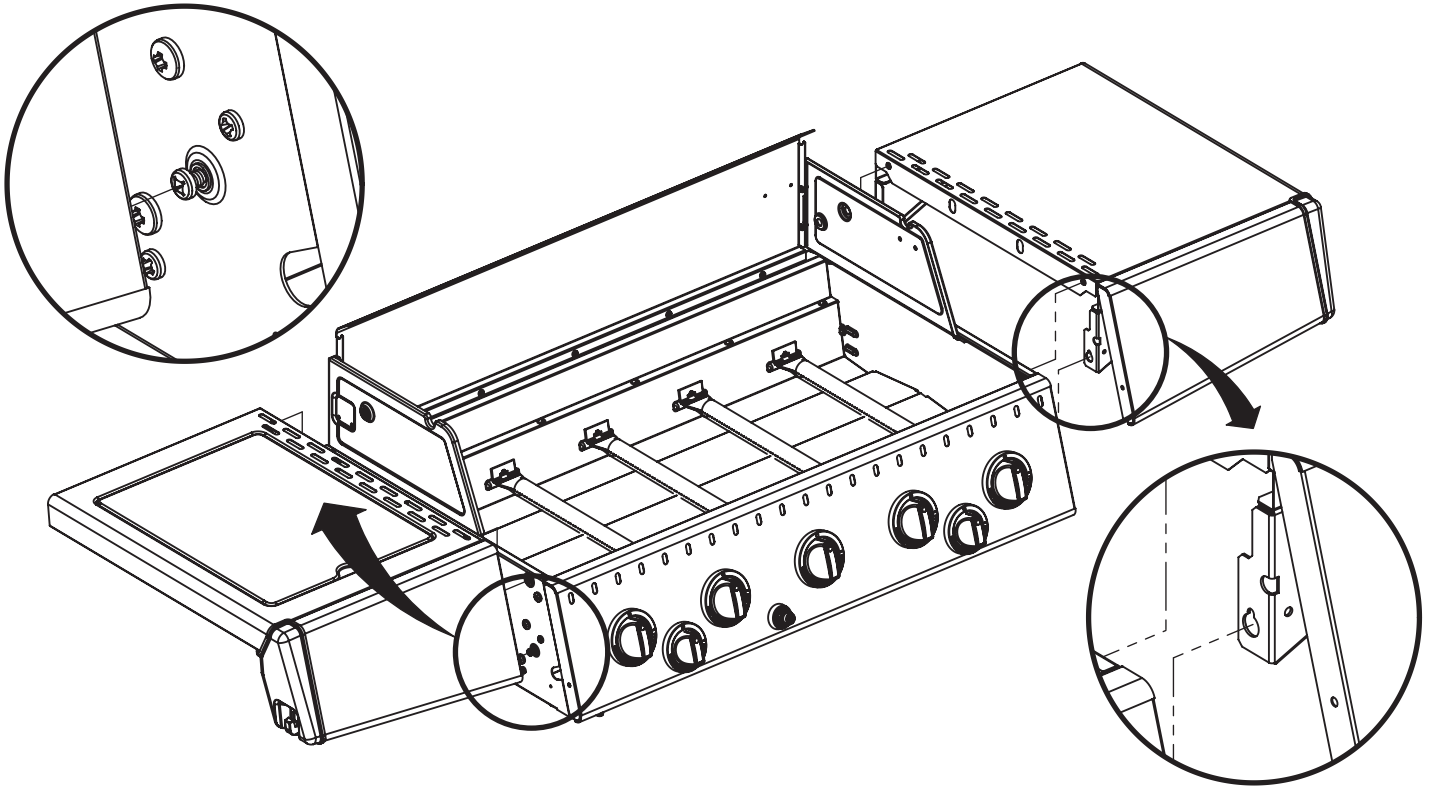

13

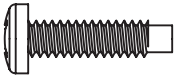
(4) 

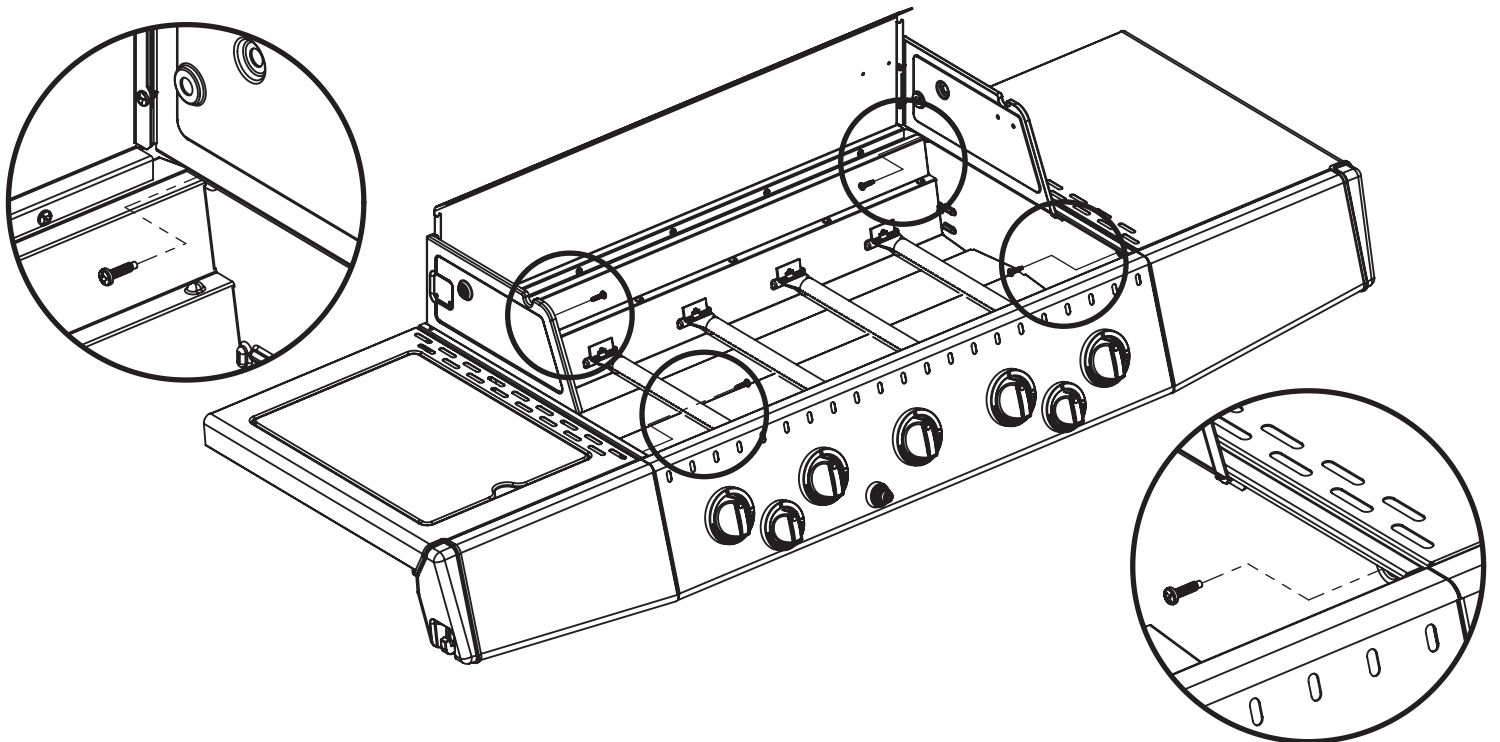

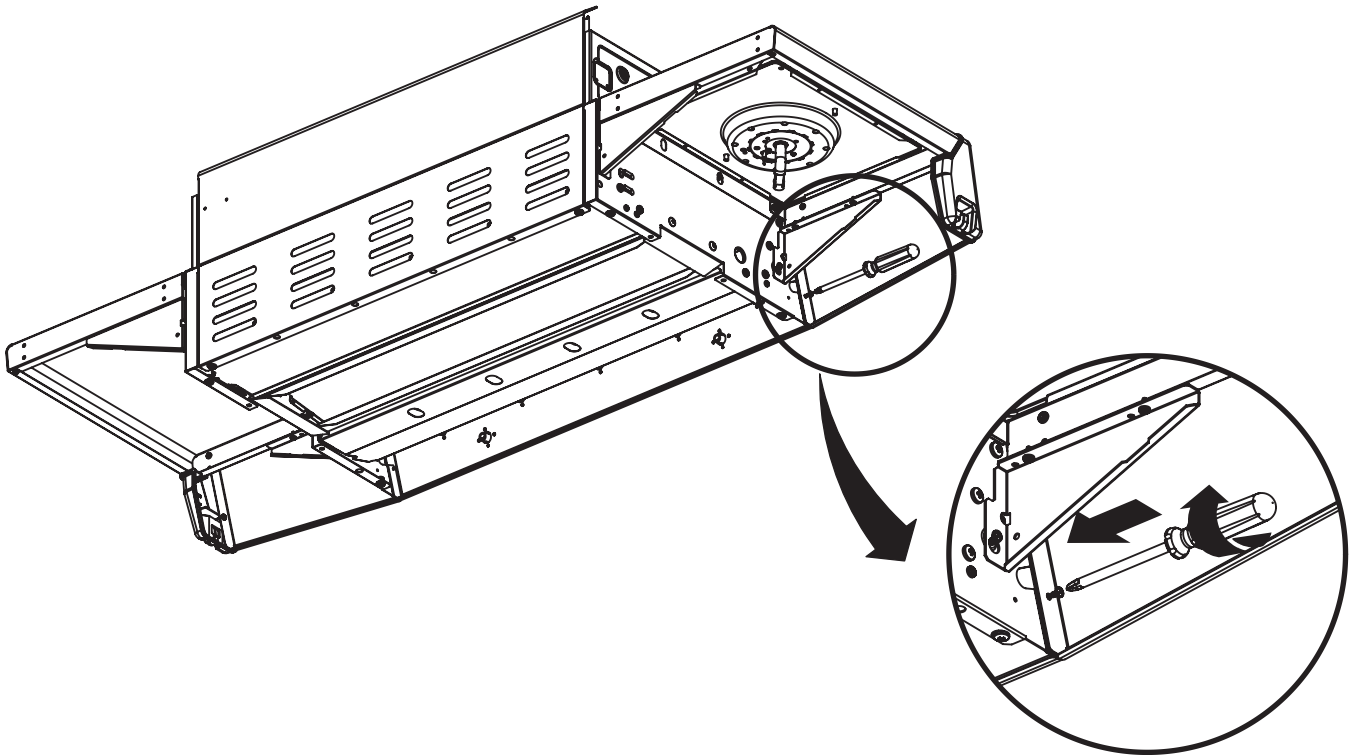
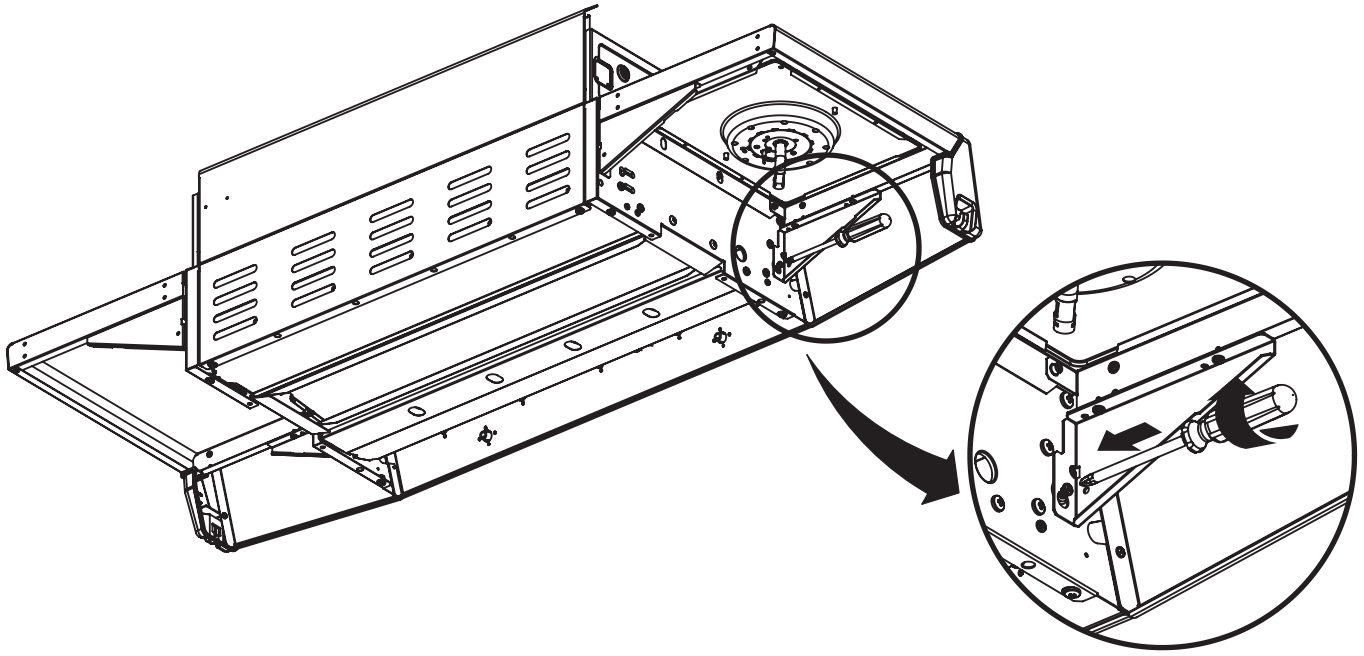

1

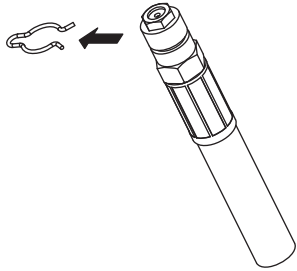

2

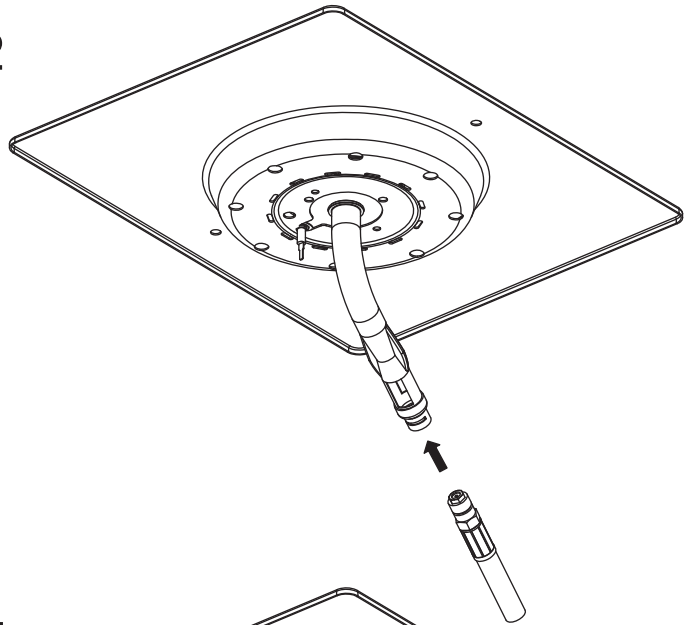

3

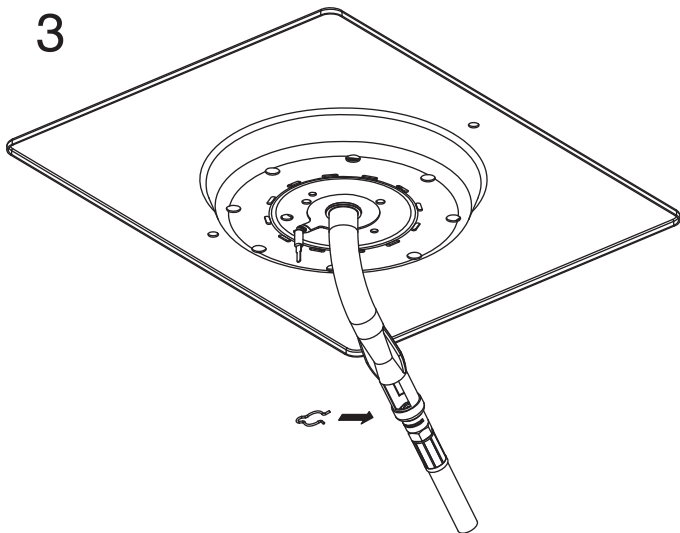

4

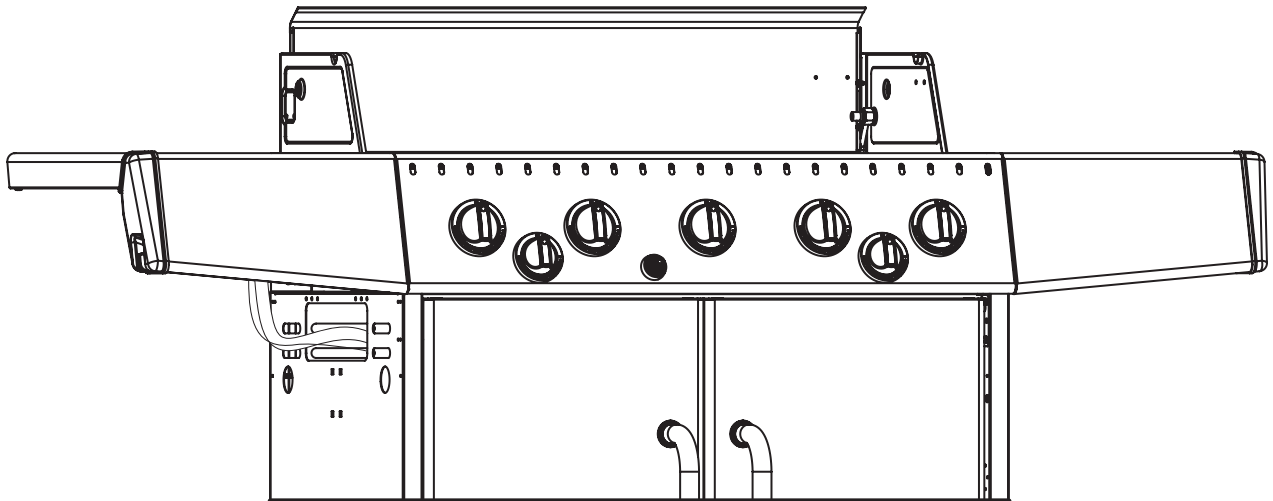
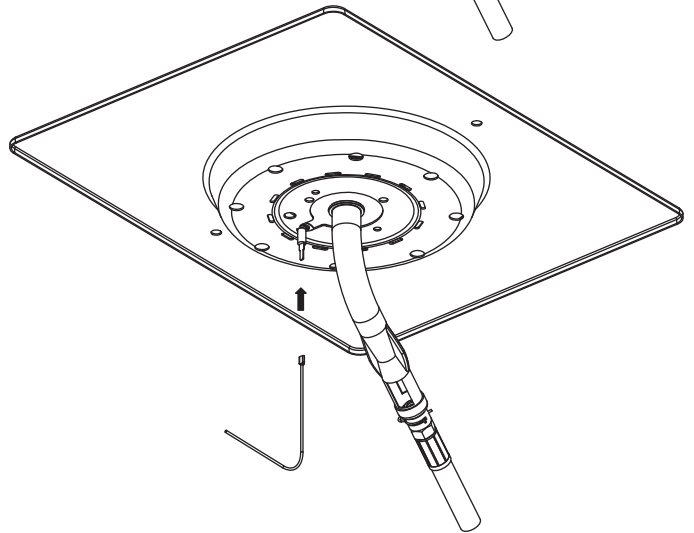

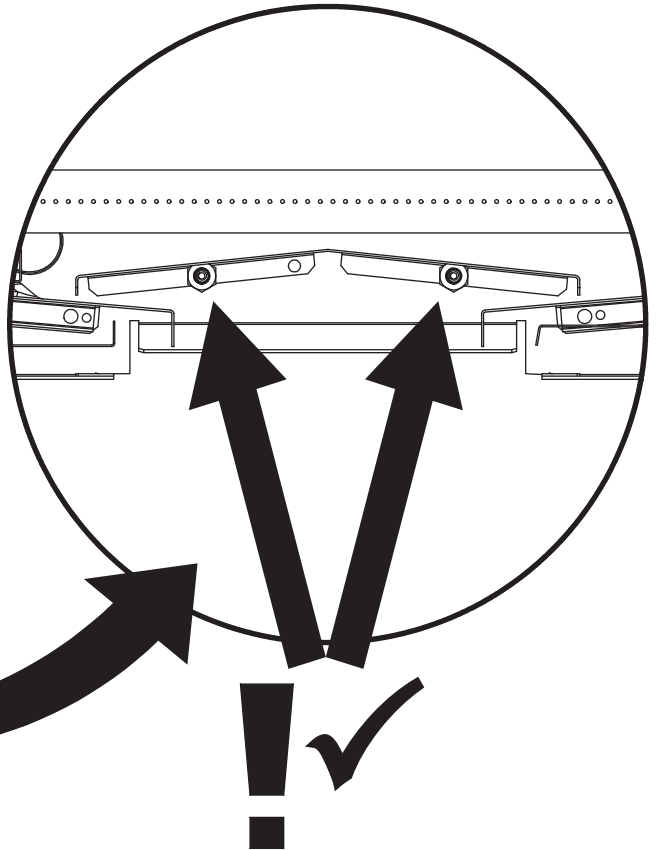
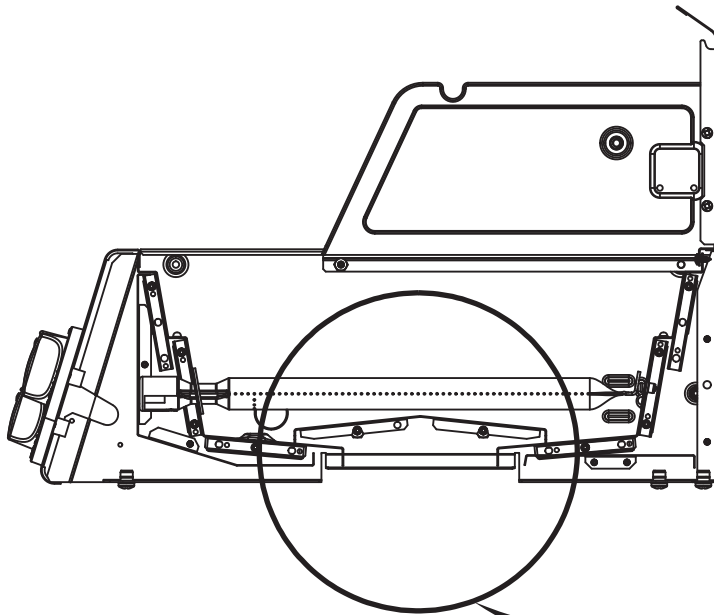
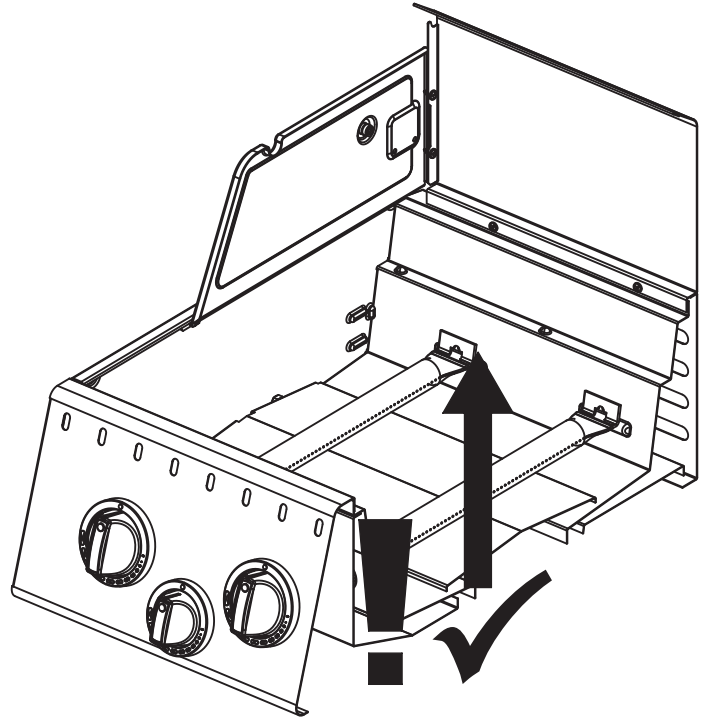
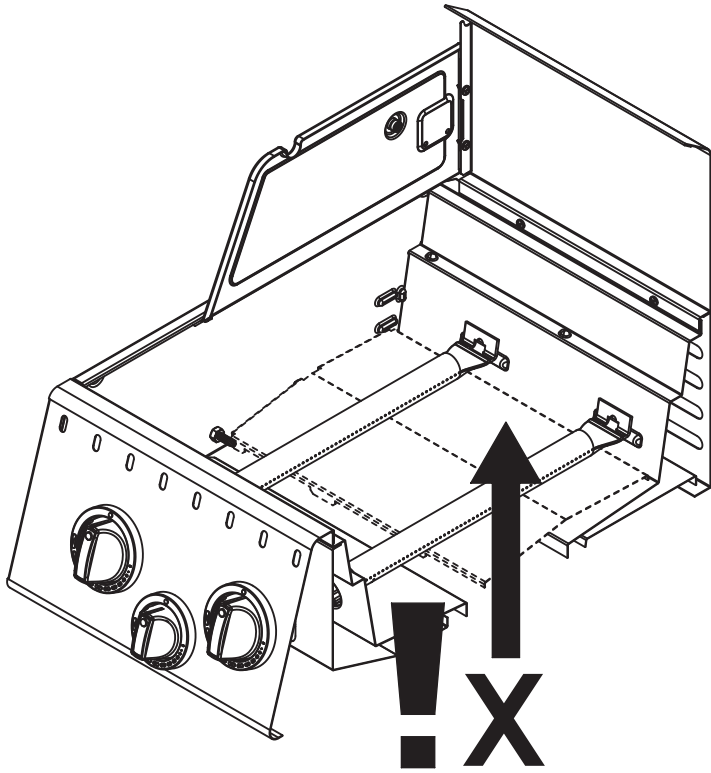

17

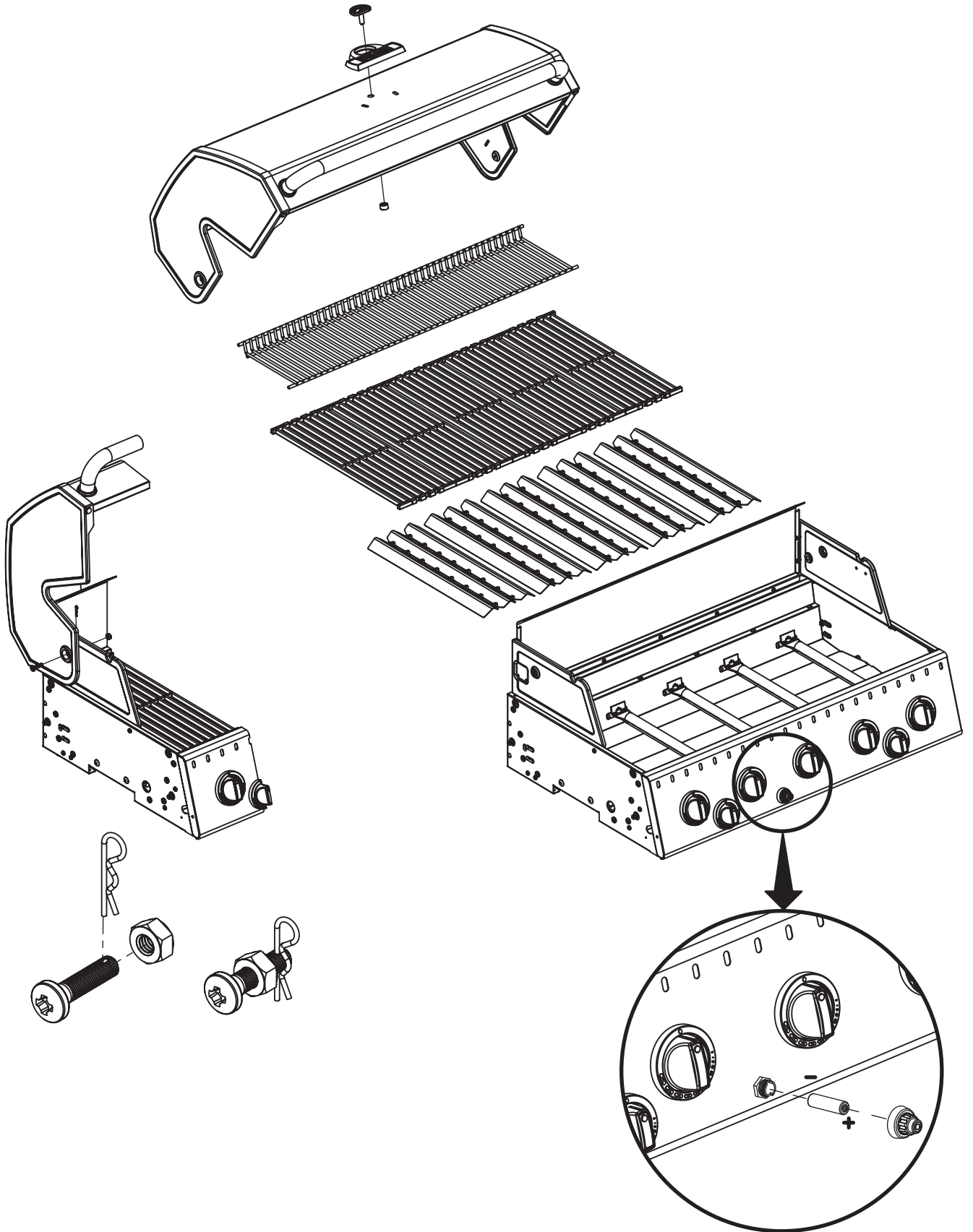
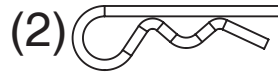
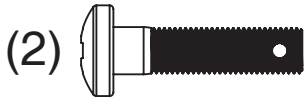

18

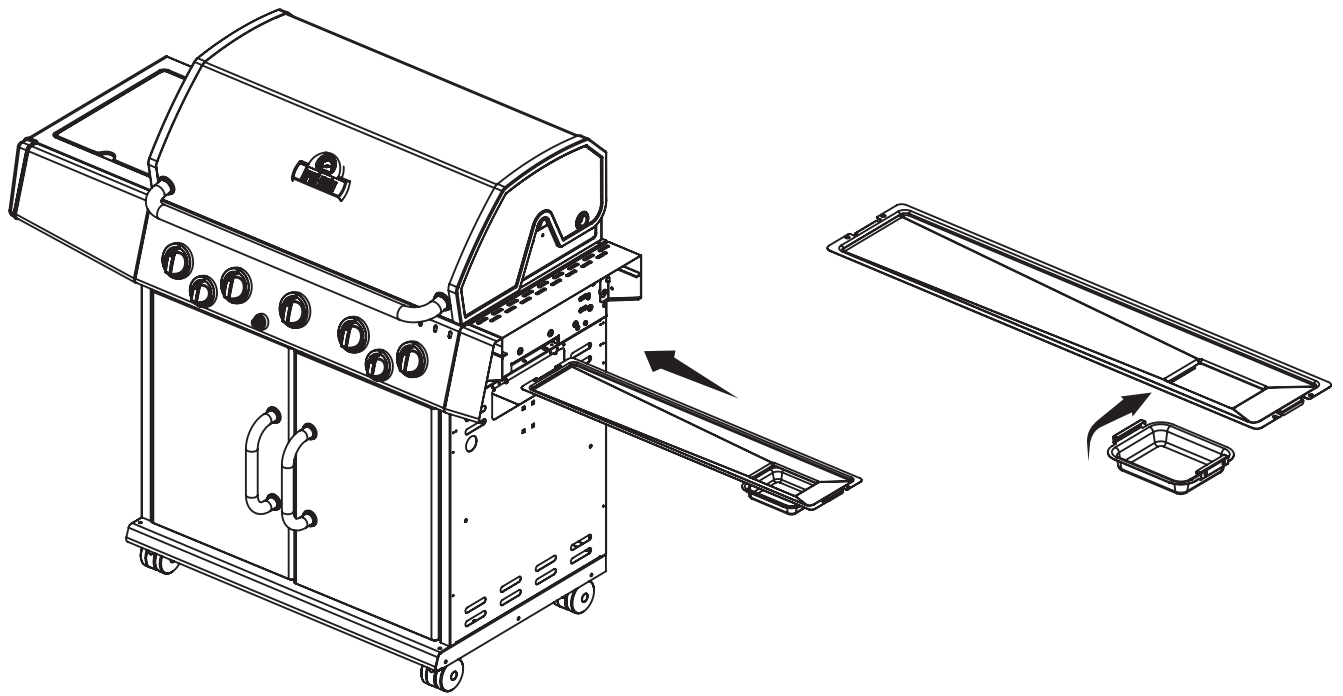

19

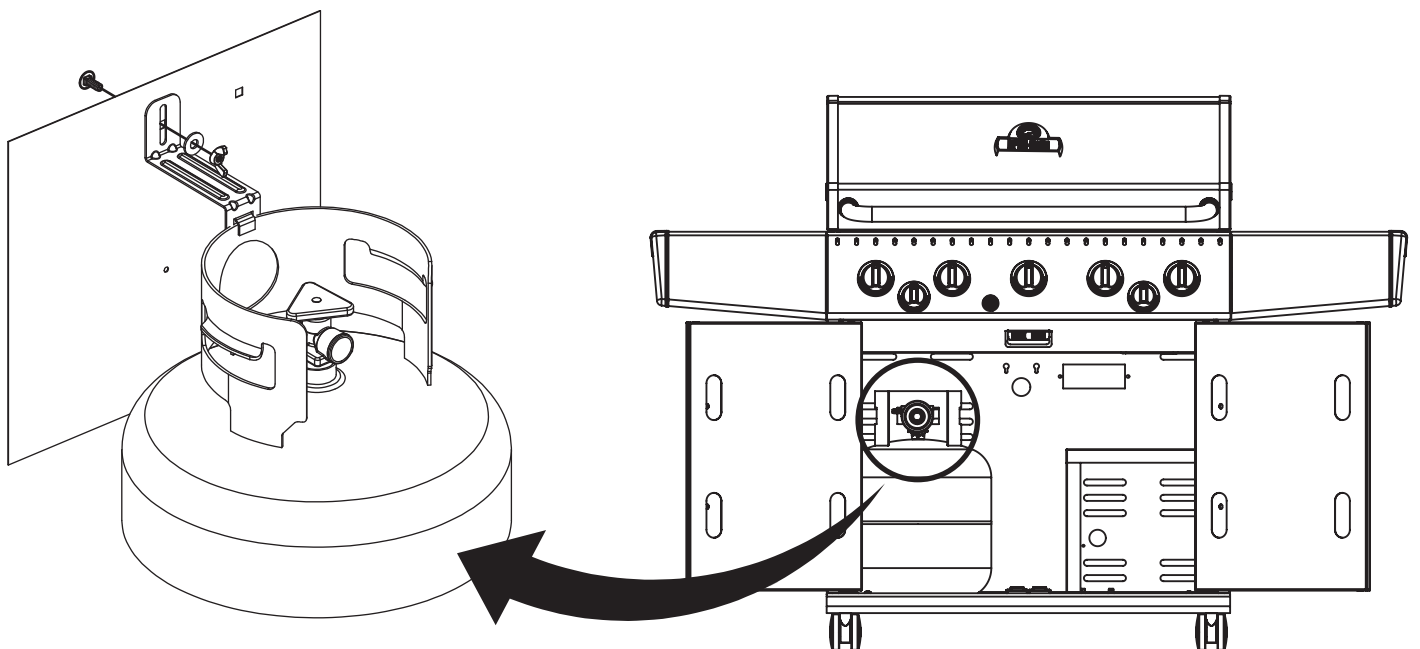

20

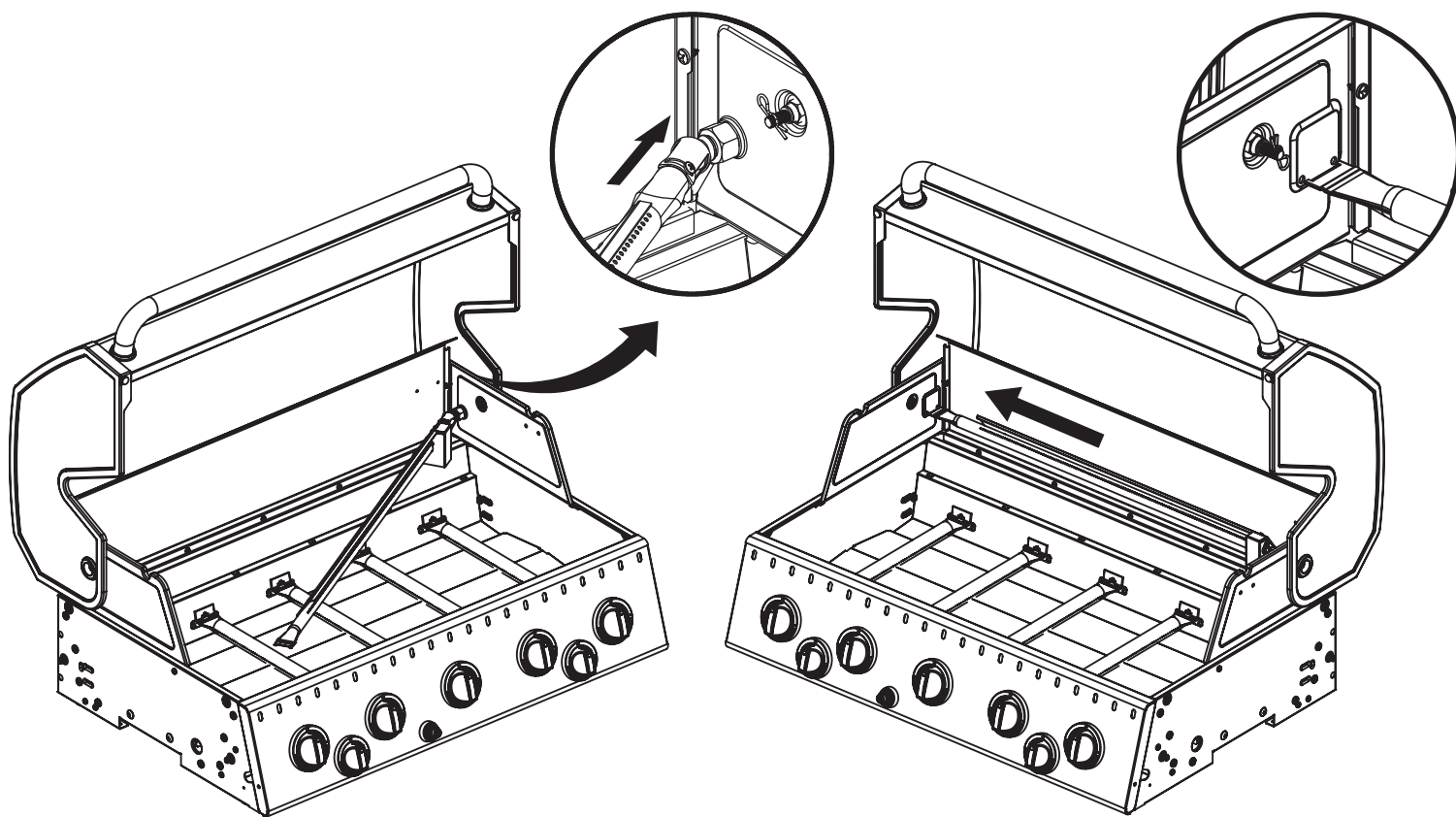

21

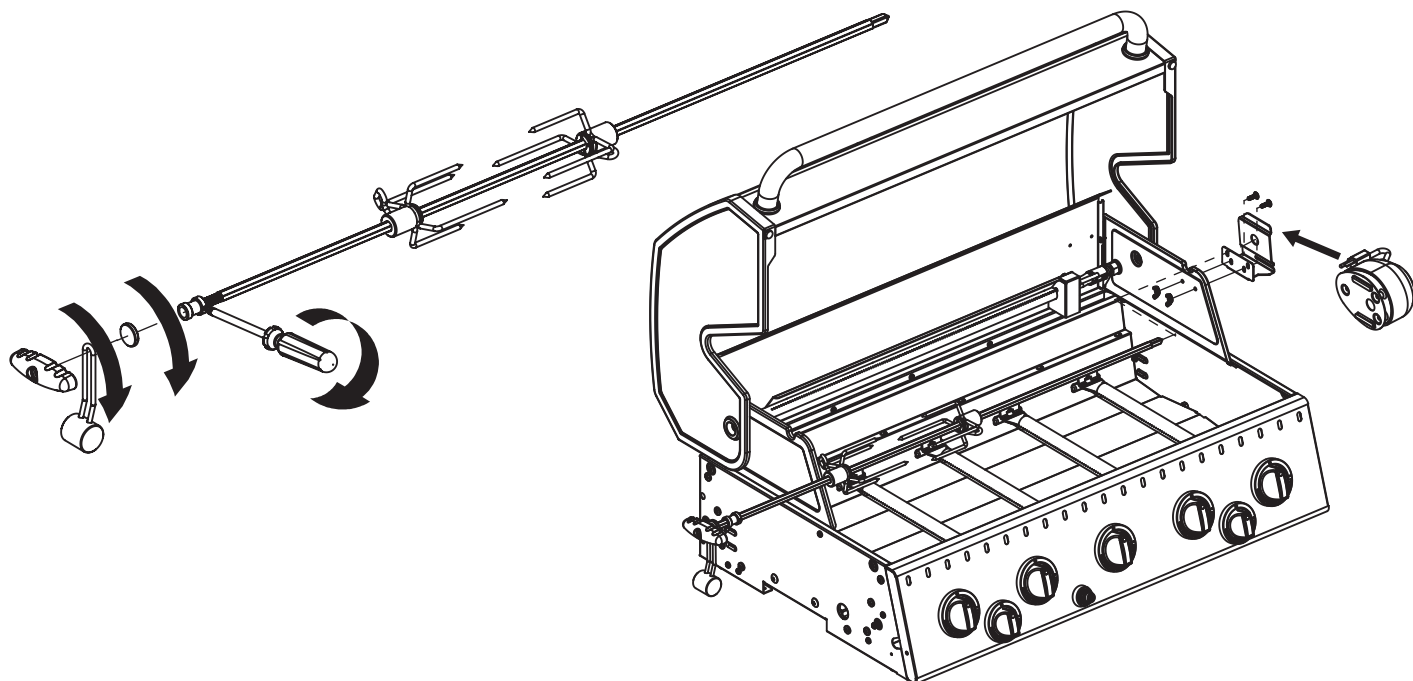

PARTS LIST / LISTE DES PIECES

KEY #	ITEM #	DESCRIPTION	DESCRIPTION	9123-84NZ	9123-87NZ	9133-84NZ	9133-87NZ
1	56104-331	LID - SIDE PANEL - LEFT	COUVERCLE - PANNEAU LATERAL - GAUCHE	1	1	1	1
2	56104-311	LID - SIDE PANEL - RIGHT	COUVERCLE - PANNEAU LATERAL - DROITE	1	1	1	1
3	56316-304	LID - OUTER PANEL	COUVERCLE - PANNEAU EXTERIEUR	-	-	1	1
	56315-304	LID - OUTER PANEL	COUVERCLE - PANNEAU EXTERIEUR	1	1	-	-
4	56246-30	LID - INNER PANEL	COUVERCLE - PANNEAU INTERIEUR	-	-	1	1
	56245-30	LID - INNER PANEL	COUVERCLE - PANNEAU INTERIEUR	1	1	-	-
5	24006-12A	HANDLE	POIGNÉE	-	-	1	1
	24005-12A	HANDLE	POIGNÉE	1	1	-	-
6	24009-936	HANDLE BEZEL	MONTURE DE POIGNÉE	2	2	2	2
8	10081-BK630	NAMEPLATE	PLAQUE D'IDENTIFICATION	1	1	1	1
9	10571-6	HEAT INDICATOR	INDICATEUR DE CHALEUR	1	1	1	1
11	52114-131R	PANEL - SIDE UPPER - LEFT	PANNEAU - LATERAL SUPÉRIEUR - GAUCHE	1	1	1	1
12	52114-111R	PANEL - SIDE UPPER - RIGHT	PANNEAU - LATERAL SUPÉRIEUR - DROITE	1	1	1	1
15	56006-001P	COOKBOX ASSEMBLY	COOKBOX ASSEMBLEE	-	-	1	1
	56005-001P	COOKBOX ASSEMBLY	COOKBOX ASSEMBLEE	1	1	-	-
17	27246-904	GREASE SHEILD	PROTECTION CONTRE LA GRAISSE	-	-	1	1
	27245-904	GREASE SHEILD	PROTECTION CONTRE LA GRAISSE	1	1	-	-
18	52046-91	HEAT SHEILD - FRONT	PROTECTION CONTRE LA CHALEUR - FRONTAL	-	-	1	1
	52045-91	HEAT SHEILD - FRONT	PROTECTION CONTRE LA CHALEUR - FRONTAL	1	1	-	-
19	52046-92	HEAT SHEILD - REAR	PROTECTION CONTRE LA CHALEUR - INTÉRIEUR	-	-	1	1
	52045-92	HEAT SHEILD - REAR	PROTECTION CONTRE LA CHALEUR - INTÉRIEUR	1	1	-	-
22	52306-121R	PANEL - REAR	PANNEAU - RECIPIENT	-	-	1	1
	52305-121R	PANEL - REAR	PANNEAU - RECIPIENT	1	1	-	-
23	52316-151	PANEL - HOOD	PANNEAU DE LA CUVE	-	-	1	1
	52315-151	PANEL - HOOD	PANNEAU DE LA CUVE	1	1	-	-
25	52904-144	BURNER - MAIN	BRÛLEUR - PRINCIPAL	4	4	5	5
26	52226-014	COLLECTOR BOX - FRONT LOWER	RECIPIENT - FRONTAL INFÉRIEUR	-	-	1	1
	52225-014	COLLECTOR BOX - FRONT LOWER	RECIPIENT - FRONTAL INFÉRIEUR	1	1	-	-
27	52216-014	COLLECTOR BOX - FRONT UPPER	RECIPIENT - FRONTAL SUPÉRIEUR	-	-	1	1
	52215-014	COLLECTOR BOX - FRONT UPPER	RECIPIENT - FRONTAL SUPÉRIEUR	1	1	-	-
28	52016-304	CONTROL COVER	PANNEAU DE CONTROLE	-	-	1	1
	52015-244	CONTROL COVER	PANNEAU DE CONTROLE	1	1	-	-
29	59006-074	CONTROL ASSEMBLY	SOUPAPE	-	-	1	-
	59006-077	CONTROL ASSEMBLY	SOUPAPE	-	-	-	1
	59005-074	CONTROL ASSEMBLY	SOUPAPE	1	-	-	-
	59005-077	CONTROL ASSEMBLY	SOUPAPE	-	1	-	-
30	S13470-091	HOSE - SIDE BURNER	TUYAU - BRÛLEUR DE CÔTÉ	1	-	1	-
	S13470-132	HOSE - SIDE BURNER	TUYAU - BRÛLEUR DE CÔTÉ	-	1	-	1
31	10114-20	HOSE & REGULATOR	TUYAU ET REGULATEUR PL	1	-	1	-
	10111-K45	HOSE NATURAL GAS	TUYAU (GAZ NATUREL)	-	1	-	1
32	27906-354	REAR BURNER	BRÛLEUR - ARRIÈRE	-	-	1	1
	27905-354	REAR BURNER	BRÛLEUR - ARRIÈRE	1	1	-	-
36	10342-T17	ELECTRODE - REAR BURNER	ÉLECTRODE - BRÛLEUR - ARRIÈRE	-	-	1	1
38	22002-268	CONTROL BEZEL	MONTURE DE CONTROLE	5	5	5	5
39	22001-168	CONTROL BEZEL	MONTURE DE CONTROLE	2	2	2	2
40	10472-K431	CONTROL KNOB	BOUTON DE CONTROLE	5	5	5	5
41	10472-K231	CONTROL KNOB	BOUTON DE CONTROLE	2	2	2	2
42	10342-251	ELECTRONIC IGNITOR	ALLUMAGE ÉLECTRONIQUE	1	1	1	1
43	10342-E13	ELECTRODE	ÉLECTRODE	2	2	3	3
44	52209-404	FLAV-R-WAVE ®	FLAV-R-WAVE ®	4	4	5	5
45	52007-181	GRID - PORCELAIN	GRILLE EN PORCELAINE	4	4	5	5
46	52006-991	GRID - WARMING RACK	GRILLE - MAINTIEN AU CHAUD	-	-	1	1
	52005-991	GRID - WARMING RACK	GRILLE - MAINTIEN AU CHAUD	1	1	-	-
47	27056-901	GREASE TRAY	PLATEAU A GRAISSE	-	-	1	1
	27055-901	GREASE TRAY	PLATEAU A GRAISSE	1	1	-	-
48	21036-991	GREASE TRAY - RAIL	PLATEAU A GRAISSE - FERROVIAIRE	-	-	2	2
	21035-991	GREASE TRAY - RAIL	PLATEAU A GRAISSE - FERROVIAIRE	2	2	-	-
49	22009-901	GREASE PAN	CUVETTE A GRAISSE	1	1	1	1
50	51176-115A	DOOR	PORTE	-	-	1	1
	51175-115A	DOOR	PORTE	1	1	-	-
51	51176-135A	DOOR	PORTE	-	-	1	1
	51175-135A	DOOR	PORTE	1	1	-	-
60	21109-905R	CABINET - SIDE PANEL	CABINET - PANNEAU LATÉRAL	2	2	2	2
61	21306-925R	CABINET - REAR PANEL	CABINET - PANNEAU ARRIÈRE	-	-	1	1
	21305-925R	CABINET - REAR PANEL	CABINET - PANNEAU ARRIÈRE	1	1	-	-
62	25208-205R	CABINET - SHELF	CABINET - PLATEAU	-	-	1	1
63	21036-905R	CABINET - SHELF SUPPORT	CABINET - PLATEAU DE SOUTIEN	-	-	1	1

PARTS LIST / LISTE DES PIECES

KEY #	ITEM #	DESCRIPTION	DESCRIPTION	9123-84NZ	9123-87NZ	9133-84NZ	9133-87NZ
65	51096-945	CABINET - LOWER BASE	TABLETTE INFÉRIEURE	-	-	1	-
	51096-955	CABINET - LOWER BASE	TABLETTE INFÉRIEURE	-	-	-	1
	51795-945	CABINET - LOWER BASE	TABLETTE INFÉRIEURE	1	-	-	-
	51795-955	CABINET - LOWER BASE	TABLETTE INFÉRIEURE	-	1	-	-
66	21009-905	TANK BRACKET	SUPPORT DU RESERVOIR	1	-	1	-
67	51336-115	MAGNET BRACKET	MAGNET SUPPORT	-	-	1	1
	51335-115	MAGNET BRACKET	MAGNET SUPPORT	1	1	-	-
73	21039-915	CASTER BRACKET	SUPPORT DE ROULLETTE	2	2	2	2
74	10892-23	CASTER	ROULETTES	4	4	4	4
80	53101-615	SIDE SHELF	TABLETTE DE CÔTÉ	1	1	1	1
81	23030-615	SIDE SHELF - BRACKET RIGHT	TABLETTE DE CÔTÉ - SUPPORT DROITE	2	2	2	2
82	23030-635	SIDE SHELF - BRACKET LEFT	TABLETTE DE CÔTÉ - SUPPORT GAUCHE	2	2	2	2
83	53405-111	SIDE SHELF - STAINLESS STEEL FASCIA RIGHT	TABLETTE DE CÔTÉ - FASCIA A DROITE ACIER INOXYDABLE	1	1	1	1
84	53101-655	SIDE SHELF - SIDE BURNER	TABLETTE DE CÔTÉ - BRÛLEUR DE CÔTÉ	1	1	1	1
85	53405-113	SIDE SHELF - STAINLESS STEEL FASCIA LEFT	TABLETTE DE CÔTÉ - FASCIA A GAUCHE ACIER INOXYDABLE	1	1	1	1
86	10390-E10	SIDE BURNER	BRÛLEUR DE CÔTÉ	1	1	1	1
87	23000-271	SIDE BURNER - BODY	BRÛLEUR DE CÔTÉ - CORPS	1	1	1	1
88	23000-251	SIDE BURNER - COVER	BRÛLEUR DE CÔTÉ - COUVERCLE	1	1	1	1
89	53139-98	SIDE BURNER GRID	BRÛLEUR DE CÔTÉ - GRILLE	1	1	1	1
90	21071-13	DOOR HANDLE	POIGNÉE DE LA PORTE	2	2	2	2
92	10342-T18	SIDE BURNER ELECTRODE	ÉLECTRODE DU BRÛLEUR DE CÔTÉ	1	1	1	1
94	56305-911	SIDE SHELF - RESIN FASCIA RIGHT	TABLETTE DE CÔTÉ - FASCIA A DROITE	1	1	1	1
95	56305-913	SIDE SHELF - RESIN FASCIA LEFT	TABLETTE DE CÔTÉ - FASCIA A GAUCHE	1	1	1	1
96	10342-T18	ELECTRODE WIRE - SIDE BURNER	FIL ÉLECTRODE - BRÛLEUR DE CÔTÉ	1	1	1	1
100	S15260	ROTISSERIE ROD	ROTISSERIE ROD	1	1	1	1
101	S15287	ROTISSERIE FORKS	ROTISSERIE FOURCHE	1	1	1	1
102	S15263	BUSHING	BAGUE	1	1	1	1
103	S15299	WASHER	RONDELLE	1	1	1	1
104	S15270	COUNTER WIEGHT	CONTRE POIDS	1	1	1	1
105	S15271	HANDLE	POIGNÉE	1	1	1	1
106	10184-k42	ROTISSERIE BRACKET	ROTISSERIE SUPPORT	1	1	1	1
139	Y-12835	SCREW - #6 X 1/4	VIS - #6 X 1/4	2	2	6	6
140	S21125	SCREW - #8 X 3/8	VIS - #8 X 3/8	27	27	28	28
142	S21124	SCREW - #8 X 1/2	VIS - #8 X 1/2	17	17	19	19
143	Y-12855	BOLT - 1/4-20 X 3/8	BOULON - 1/4-20 X 3/8	42	42	48	48
145	10240-23	HINGE PIN	GOUPILLE DE CHARNIÈRE	2	2	2	2
146	S21233	HINGE PIN - CLIP	ATTACHE DE CHEVILLE	2	2	2	2
147	Y-11231	LID BUMPER	BUTOIR DU COUVERCLE	4	4	4	4
156	Y-11793	NUT - 1/4-20	ÉCROU - 1/4-20	10	10	14	14
158	Y-12646	SCREW - SHOULDER #8 X 1/2	VIS - SHOULDER #8 X 1/2	6	6	7	7
160	Y-29304	BOLT - #10-24 X 3/8	BOULON - #10-24 X 3/8	34	34	34	34
161	Y-29307	NUT - #10-24	ECROU - #10-24	2	2	2	2
175	Y-12310	BOLT - 1/4-20 X 3/4	BOULON - 1/4-20 X 3/4	14	14	14	14
176	10240-20	DOOR HINGE PIN - TOP	CHARNIÈRE DE PORTE BROCHES - HAUT	2	2	2	2
177	10240-19	DOOR HINGE PIN - BOTTOM	CHARNIÈRE DE PORTE BROCHES - BAS	2	2	2	2
178	Y-12127	DOOR CLIP	CLIP PORTE	2	2	2	2
179	Y-12124	DOOR HINDGE COVER	CHARNIÈRE DE PORTE COUVRIR	2	2	2	2
180	Y-11560	BOLT - 1/4-20 X 1 1/2	BOULON - 1/4-20 X 1 1/2	4	4	4	4
181	Y-12860	BOLT - 1/4-20 X 1	BOULON - 1/4-20 X 1	6	6	6	6
182	Y-29310	BOLT - #10-24 X 3/4	BOULON - #10-24 X 3/4	8	8	8	8
183	S35094	SCREW - #10-24 X 5/8	VIS - #10-24 X 5/8	2	2	2	2
184	S21061	WING NUT - #10-24	ECROU PAPILLON - #10-24	2	2	2	2
185	S15242	MOTOR	MOTEUR	1	1	1	1
186	S21362	SPRING	RESSORT	1	1	1	1
187	S21255	WASHER	RONDELLE	1	-	1	-
188	S21141	CARRIAGE BOLT - 1/4-20 X 5/8	BOULON - 1/4-20 X 5/8	1	-	1	-
189	Y-11598	WING NUT - 1/4-20	ECROU PAPILLON - 1/4-20	1	-	1	-
190	Y-12222	MAGNET	MAGNET	2	2	2	2
191	Y-12223	MAGNET - SNAP IN	MAGNET - SNAP IN	2	2	2	2

