

This Owner's Manual is provided and hosted by [Appliance Factory Parts](#).



# Broil-Mate 395-4 Owner's Manual

[Shop genuine replacement parts for Broil-Mate 395-4](#)



[Find Your Broil-Mate Grill Parts - Select From 682 Models](#)

----- Manual continues below part list -----

## Available Replacement Parts for Broil-Mate 395-4

<a href="#">90101</a>	rock grate, 10 x 18.375; Arkla, Chg, Pat
<a href="#">14625</a>	warming rack universal, 15 x 6.5
<a href="#">S12208</a>	GRID UPPER 1600 +
<a href="#">119-5000-0</a>	GGK IGNITOR
<a href="#">10472-K36</a>	KNOB GAS VALVE 1 3/4 #E +
<a href="#">10390-T301</a>	BURNER ASSY OVAL PAN STYLE +
<a href="#">18627GC</a>	BURNER, DUAL 50,000 BTU
<a href="#">10222-T42</a>	GRATE 42/45 +
<a href="#">S15500</a>	IGNITOR ELECTRODE ASSY H B H BURNER
<a href="#">18626GC</a>	BURNER, DUAL 40,000 BTU
<a href="#">S12031</a>	GRID PORCELAIN WIRE 300 +
<a href="#">S12007</a>	GRID PORC WIRE
<a href="#">18647</a>	GRID PORCELAIN WIRE 2 LEVEL +
<a href="#">10222-T32</a>	GRATE 32/35 18 INCHx11 INCH +
<a href="#">18013</a>	LARGE PROBE HEAT INDICATOR
<a href="#">S15111</a>	GREASE CUP HOLDER ALL P8069A +
<a href="#">10342-22</a>	IGNITOR W/PALNUT DUAL
<a href="#">10240-13</a>	WHEEL PIN
<a href="#">S21124</a>	SCREW PHCP #8 X 12 +
<a href="#">10390-E10</a>	BURNER SIDE 10BTU W/ELEC #8 +
<a href="#">10239-7</a>	HANDLE GASKET TRIANGULAR 1/8
<a href="#">10342-T12</a>	WIRE ELECTRODE S/B FLAT/FLAT
<a href="#">S17106</a>	TANK BRACKET STRAIGHT W/HRDWRE
<a href="#">S14019</a>	NAMEPLATE BROILMATE LG FLSH +
<a href="#">10088-34B</a>	CANVAS FRONT BM BLACK 20 5/8 INCH
<a href="#">10892-931A</a>	WHEEL 7 INCH GREY WALL
<a href="#">Y-11968</a>	SCREW PHCP 3/8 16x1 3/4
<a href="#">S11426</a>	BOTTOM CASTING R/B + 2500/2700/400/700
<a href="#">10225-T09</a>	GRID PORCELAIN ROUND S/B
<a href="#">30260130</a>	SHELF SIDE REV A +

<a href="#">10711-t451b</a>	SHELF NYLON 15X12.5 EZ-BLK #H
<a href="#">S14176</a>	DECO PANEL 200/300 18.5
<a href="#">41650</a>	50-pc briquetts. ***Read ext info***
<a href="#">10338-T311</a>	LEG PTD E-Z BUILT CART
<a href="#">10156-T55</a>	HEAT SHIELD 552 2500
<a href="#">S14178</a>	DECO PANEL 400 22 7/8
<a href="#">80012</a>	regulator and hose READ ADD. INFO
<a href="#">S17346R</a>	SHELF LOWER BASE W/RIVNUTS
<a href="#">S17347R</a>	SHELF LOWER BASE PAINTED
<a href="#">18010</a>	SMALL LID HEAT INDICATOR
<a href="#">S12206</a>	WARMING RACK 2500 1998 +
<a href="#">10111-K45</a>	HOSE 3/8 INCH ASSEMBLY NG 10 FOOT +

# broil-mate™

## E-Z BILT BARBECUES

ASSEMBLY MANUAL & PARTS LIST

MANUEL DE MONTAGE & LISTE DE PIÈCES

broil-mate™  
202-4  
301-4  
302-4



broil-mate™  
322-4



broil-mate™  
370-4



broil-mate™  
395-4



broil-mate™  
441-4  
452-4  
452-7  
453-4  
456-4  
457-4  
457-7

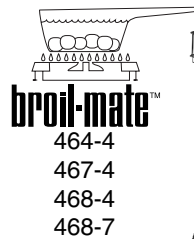

broil-mate™  
464-4  
467-4  
468-4  
468-7



RETAIN FOR FUTURE REFERENCE

VEUILLEZ CONSERVER POUR REFERENCE ULTERIEURE

*Onward*  
MANUFACTURING COMPANY  
LIMITED  
585 KUMPF DRIVE  
WATERLOO, ONTARIO, CANADA  
N2V1K3

1

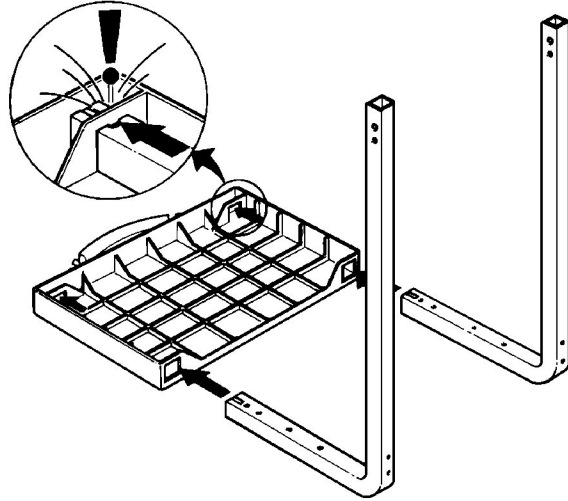

2

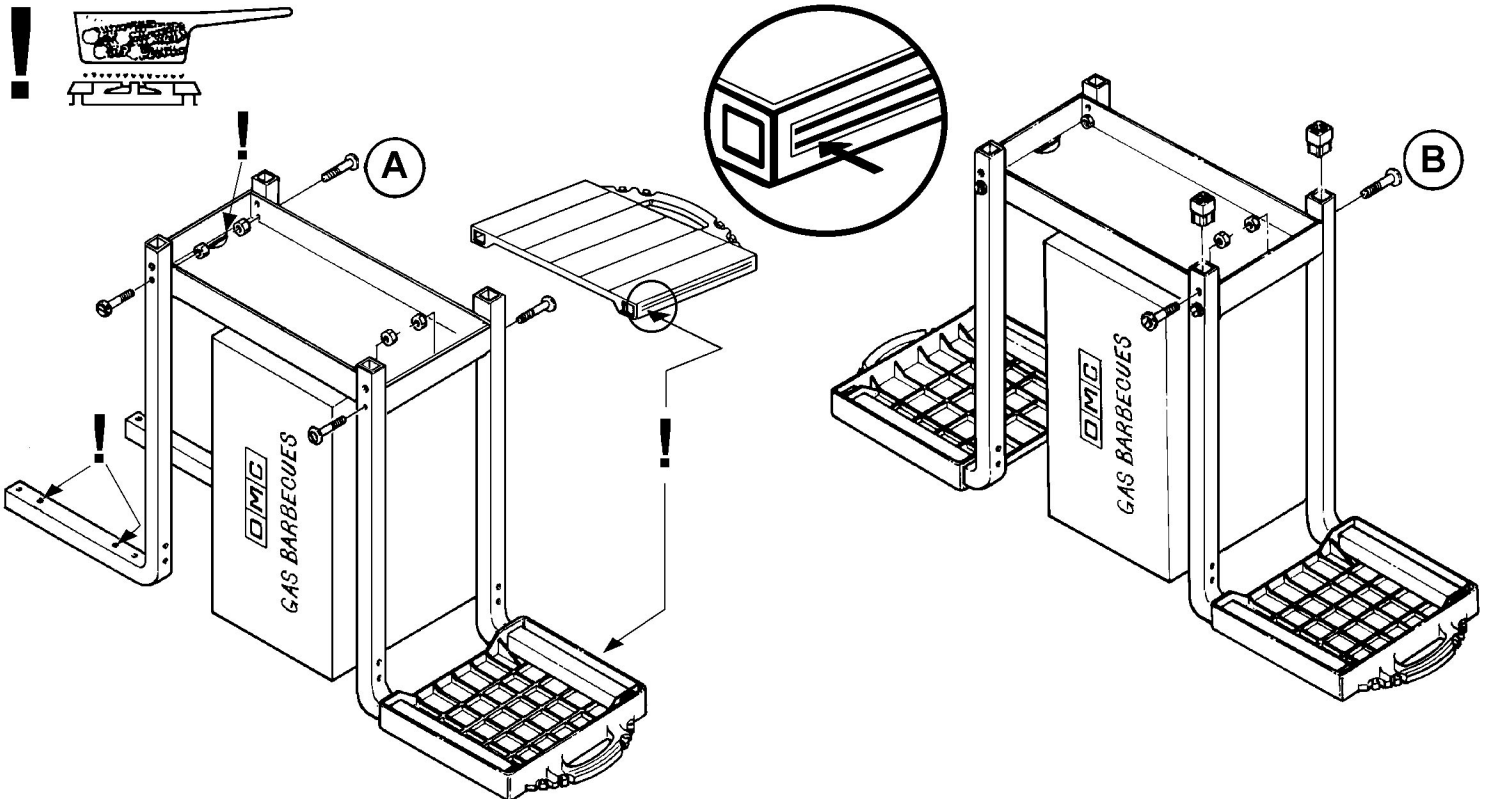
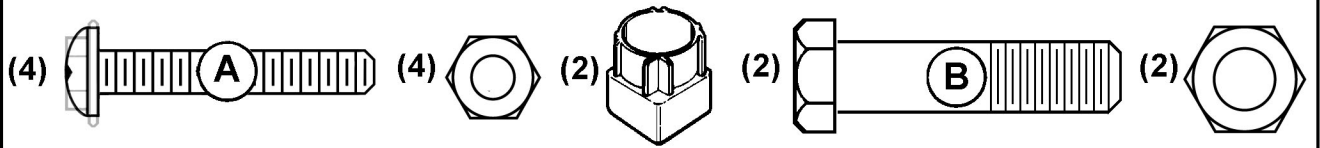

3

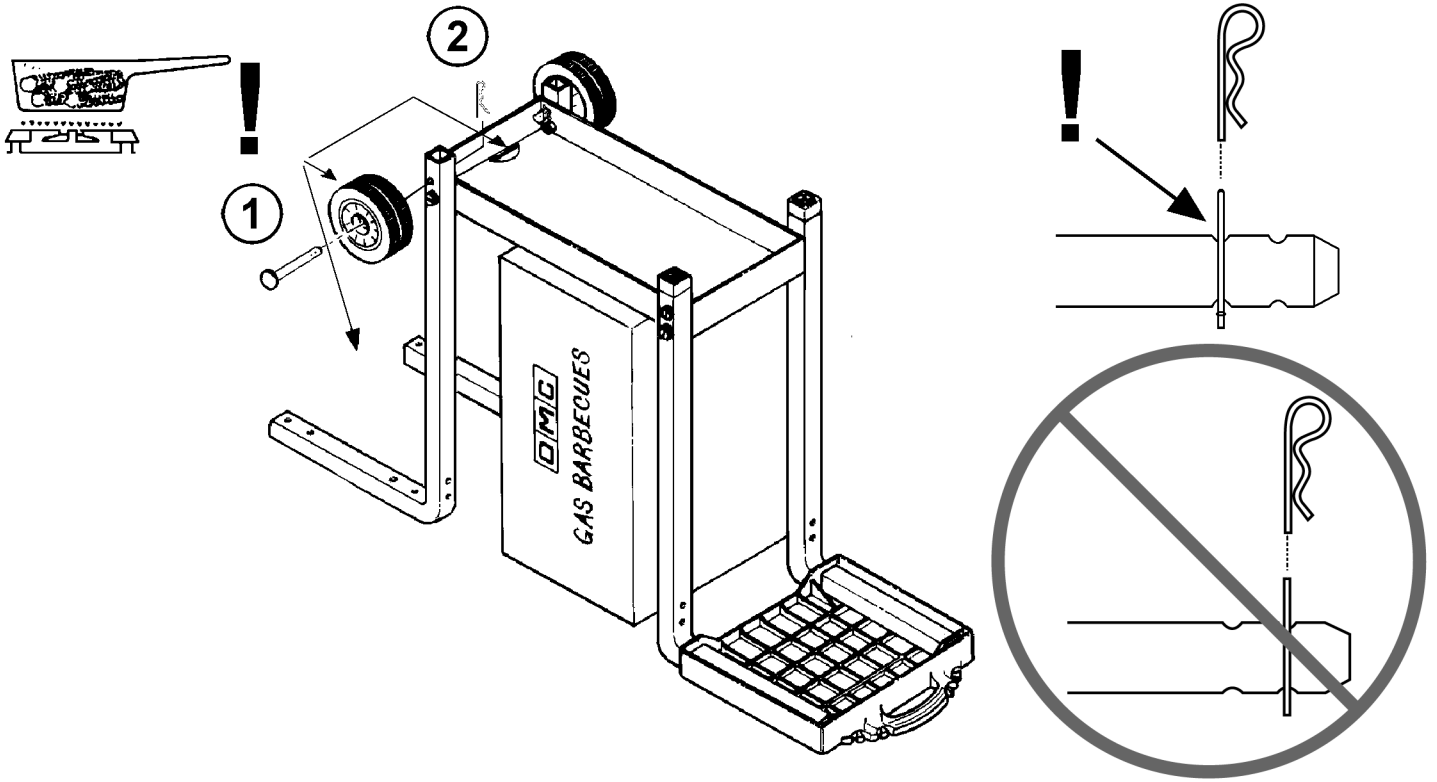
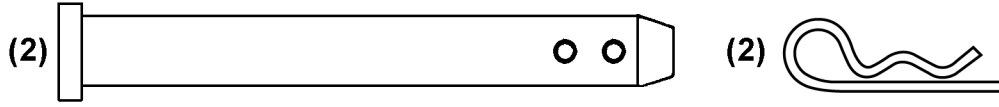

4

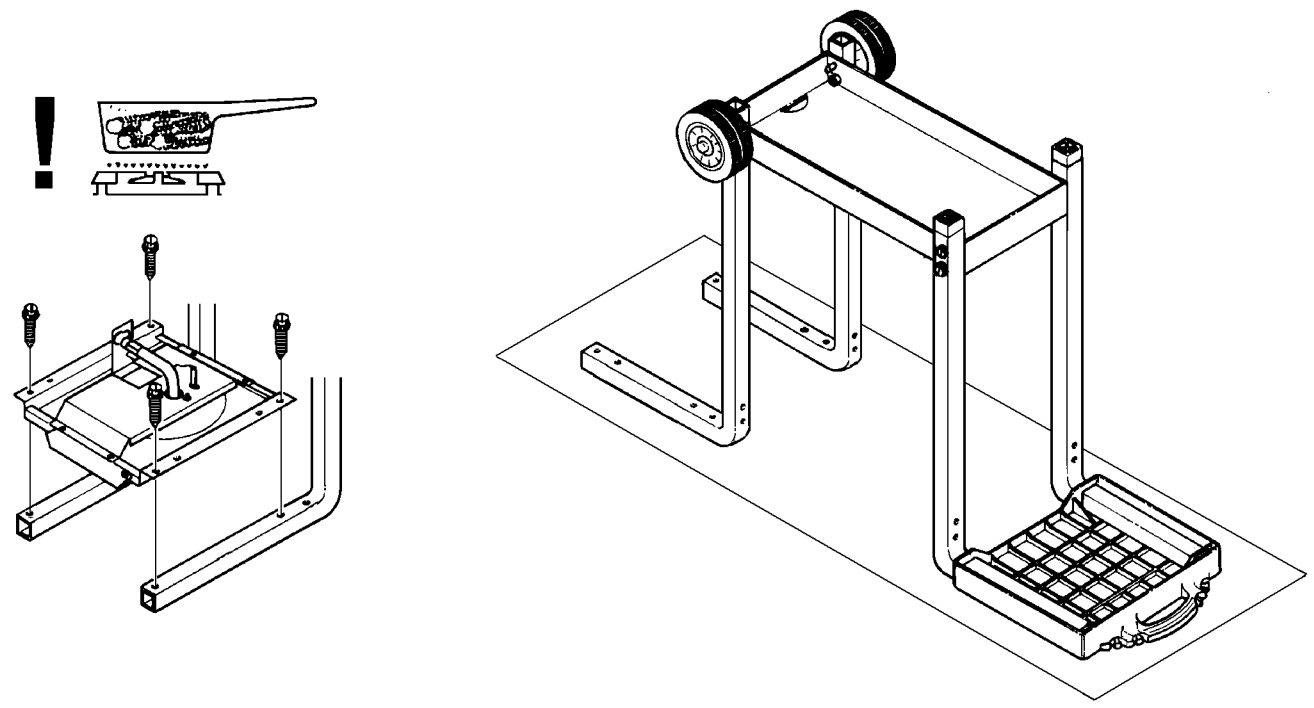
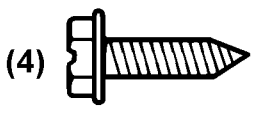

5

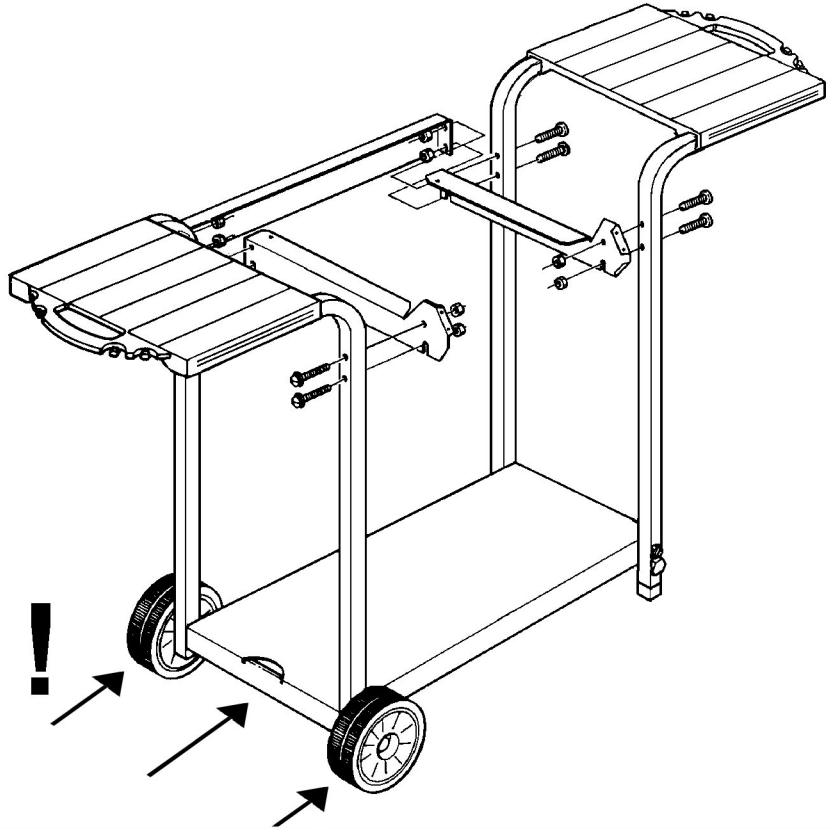
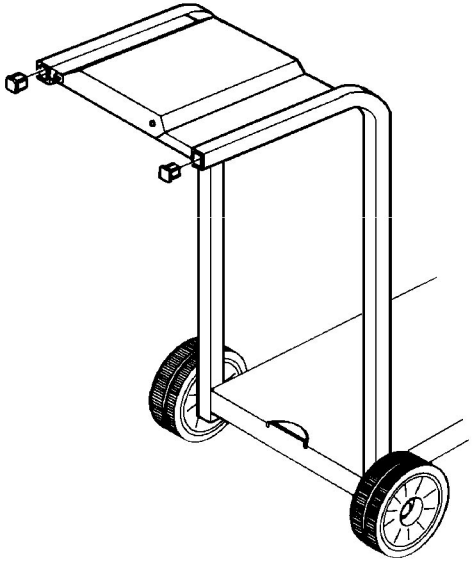
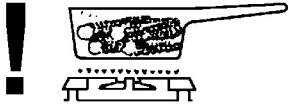
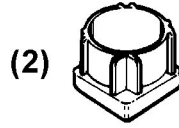
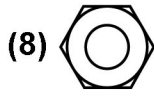

6

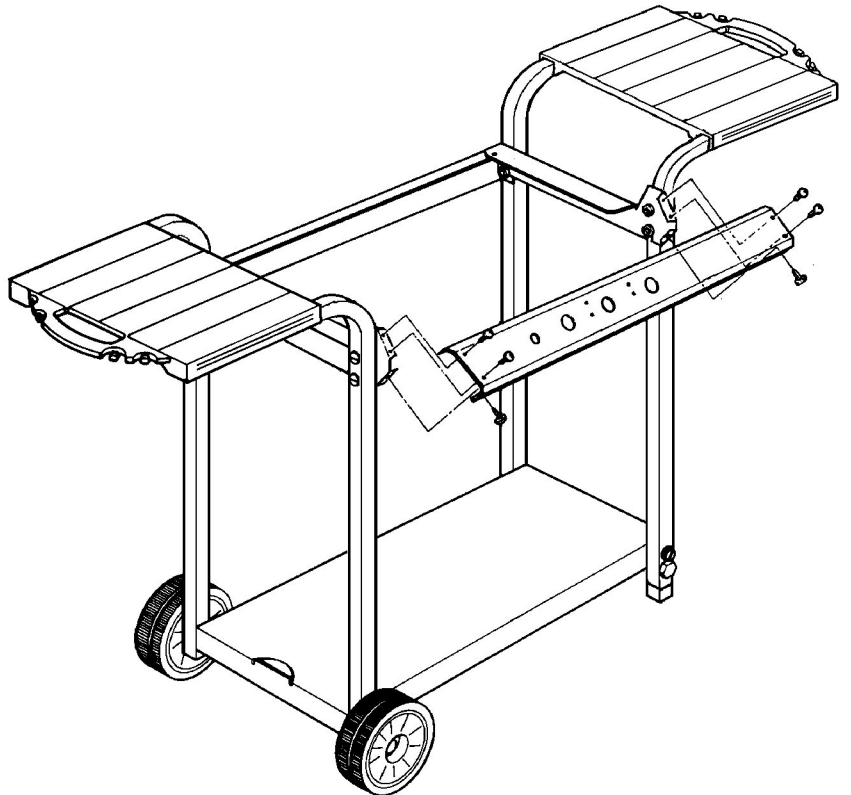
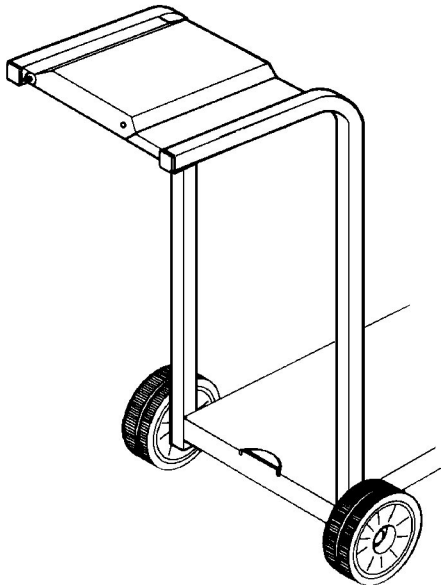
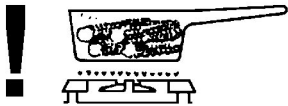

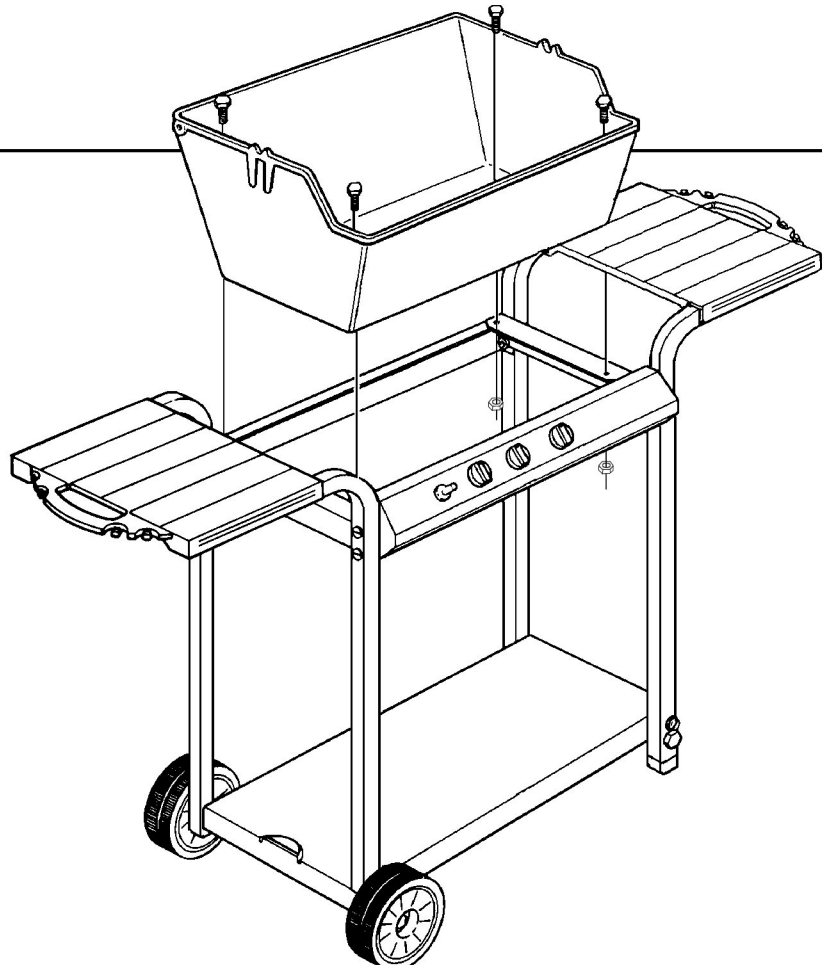
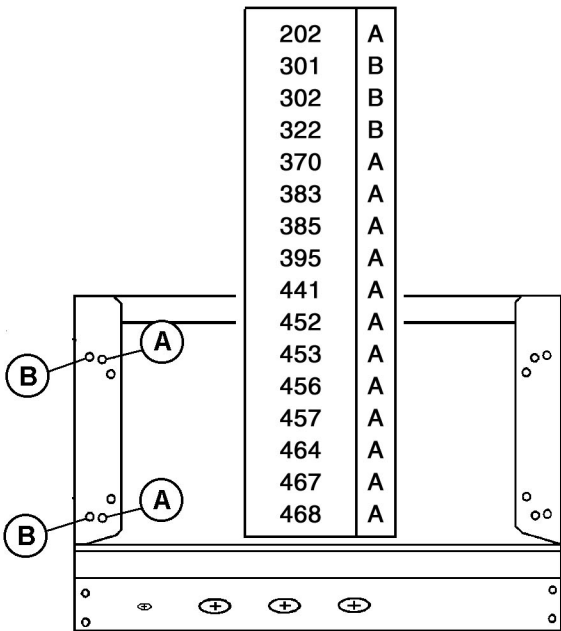
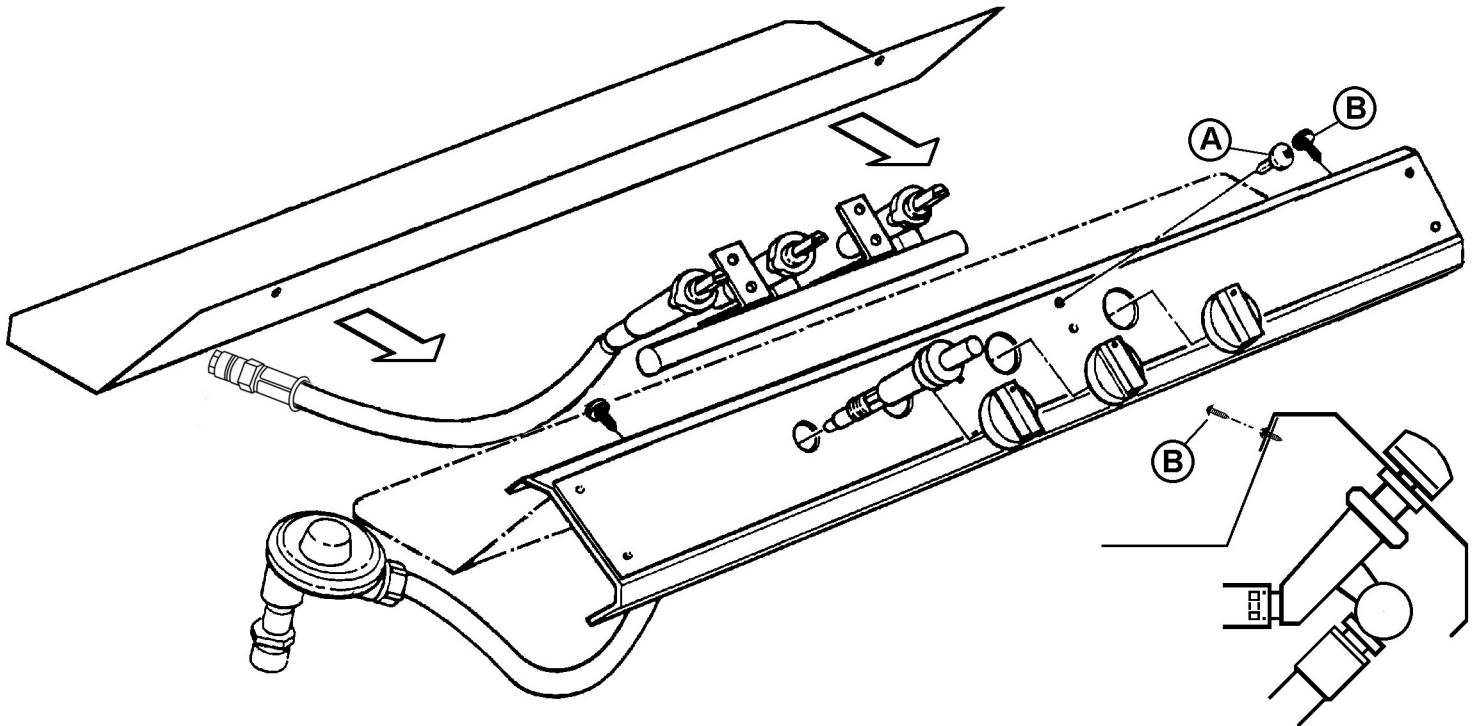
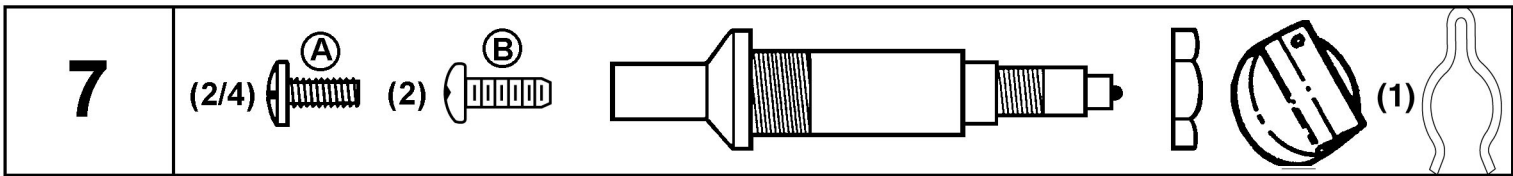

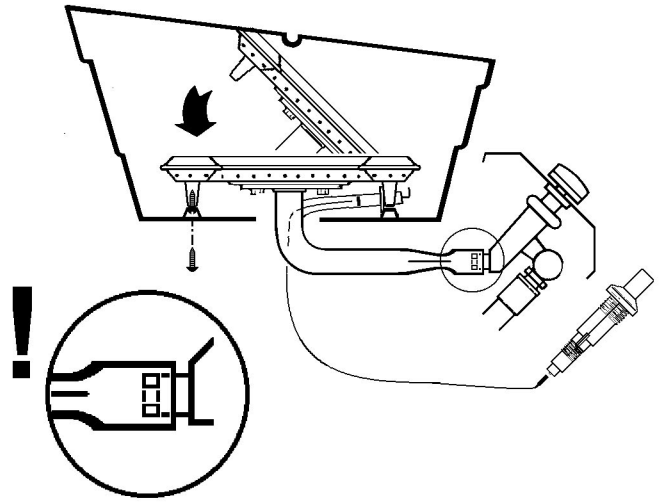
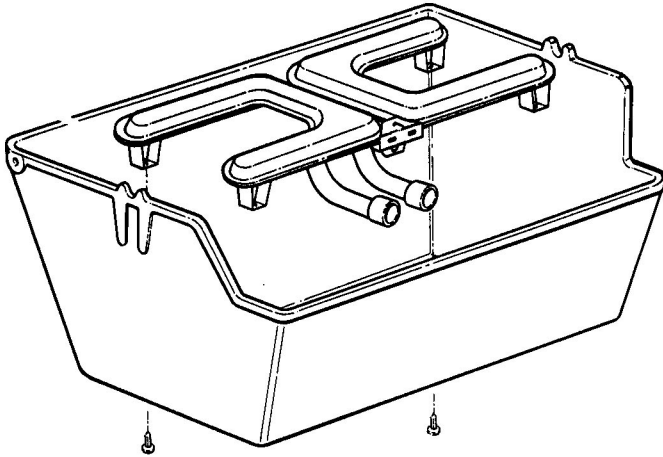

9

(2) 



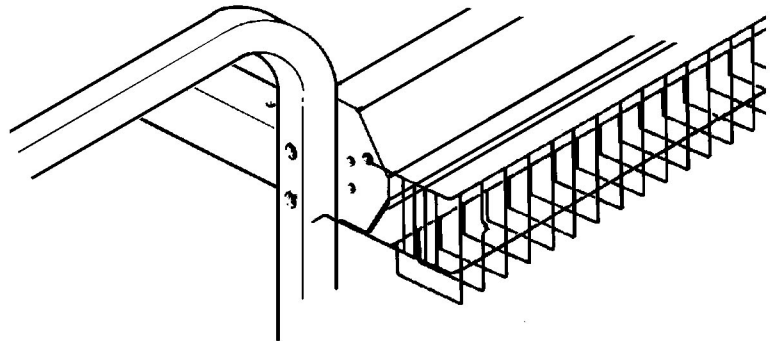
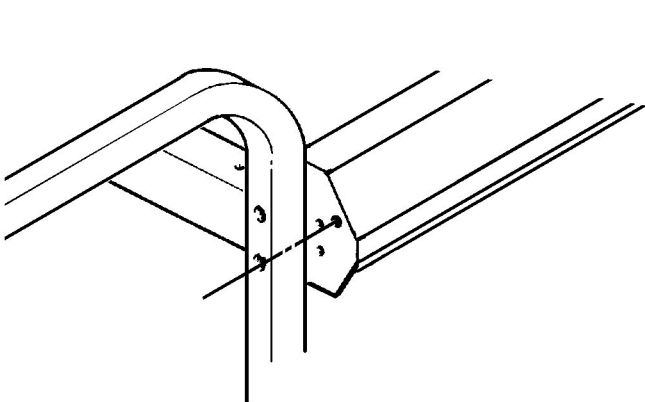
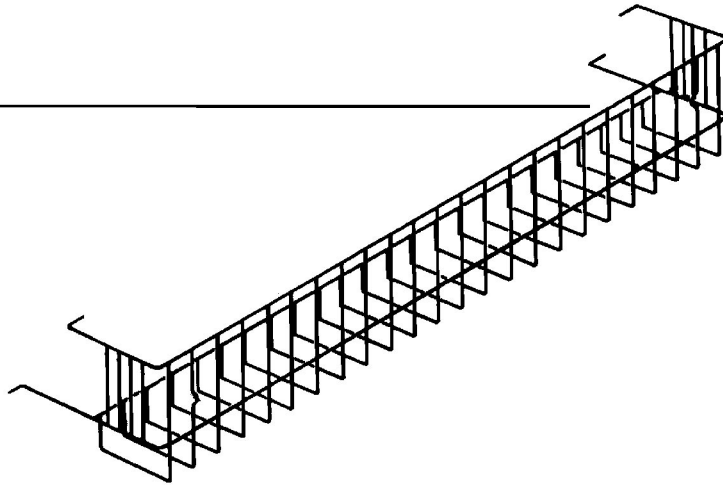

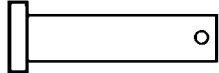

10

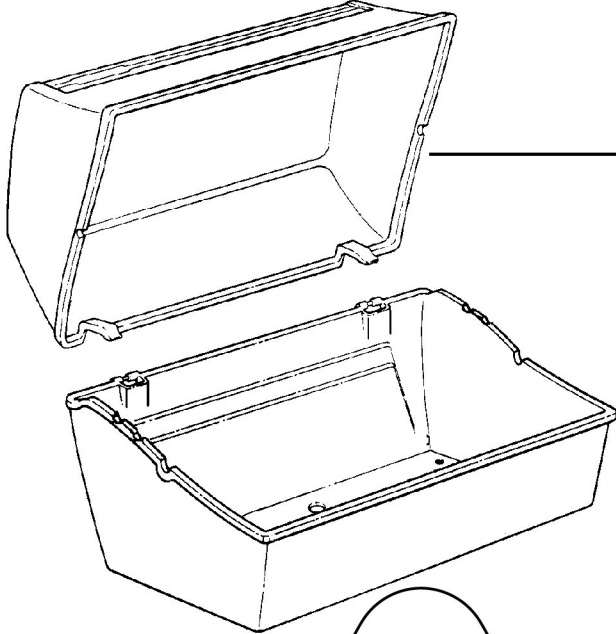
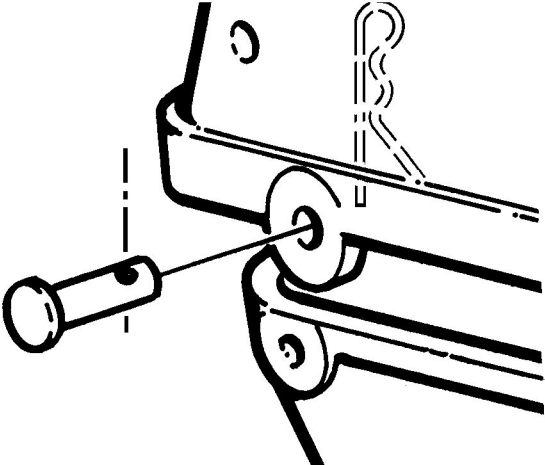

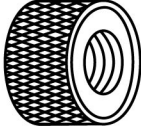

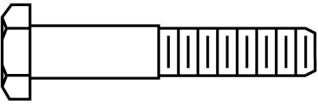
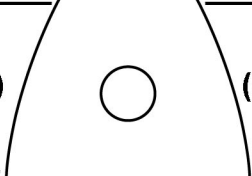
**11** (2)  (2) 

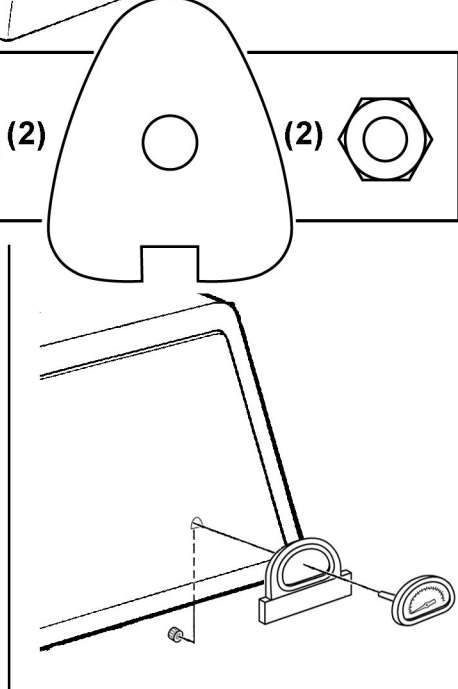
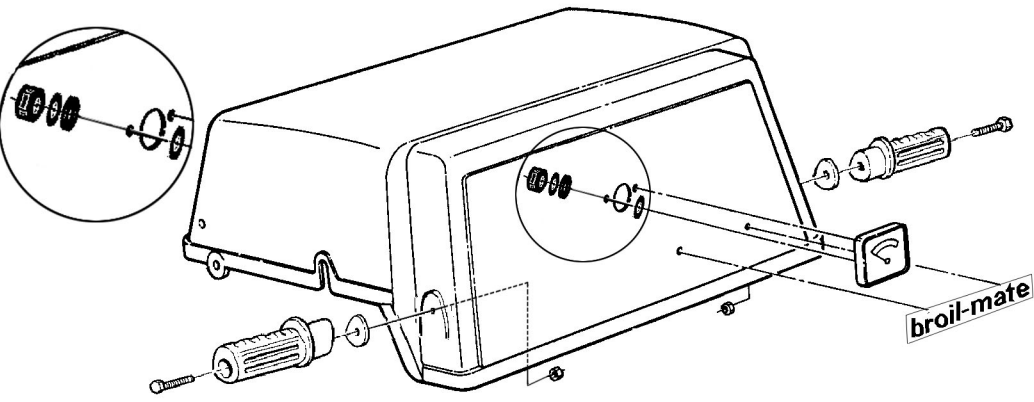

**12**    (2)  (2)  (2) 

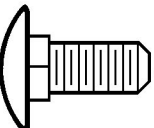

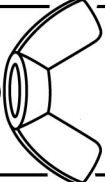
**13** (1)  (1)  (1) 

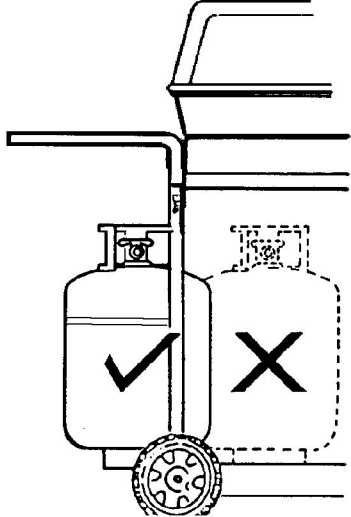
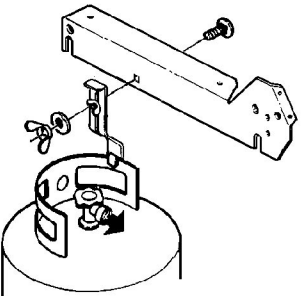

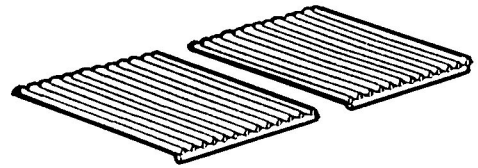
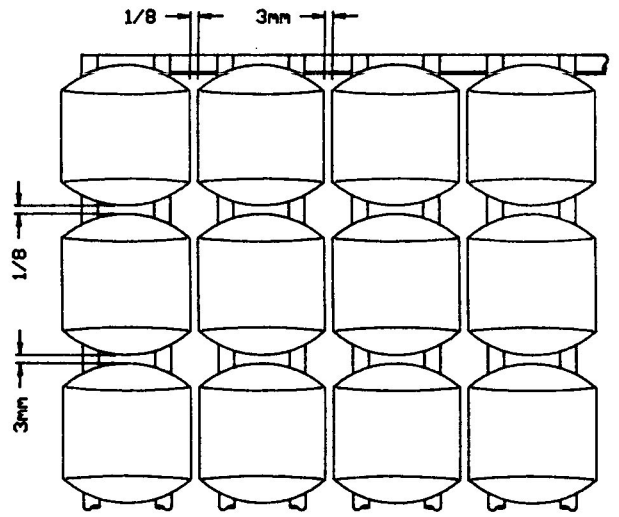
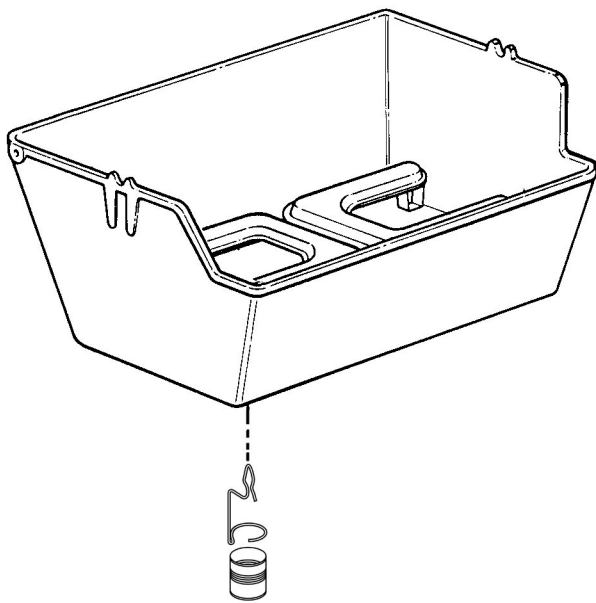
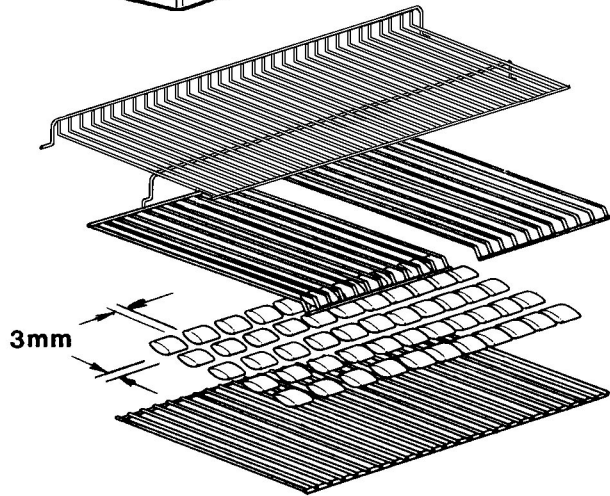
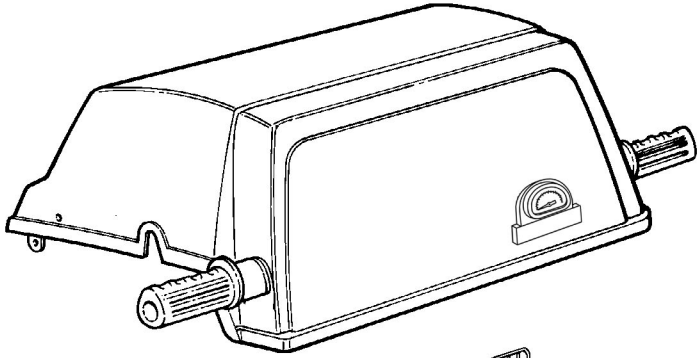

15

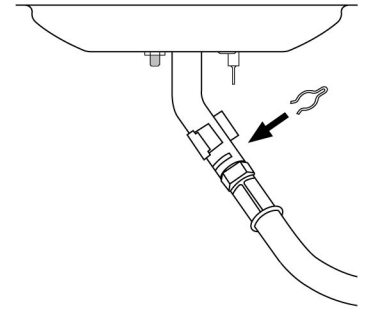
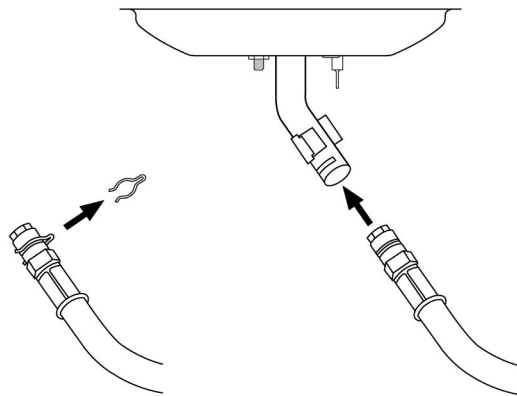
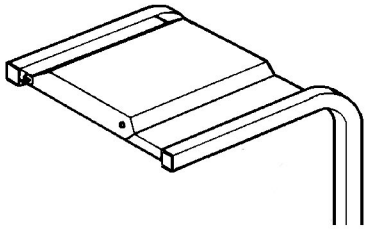
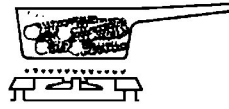

16

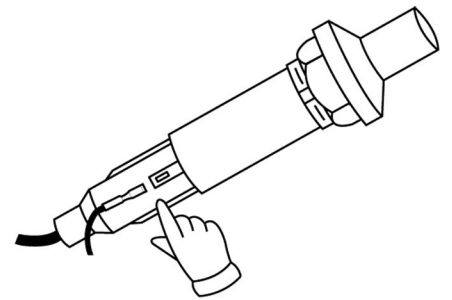
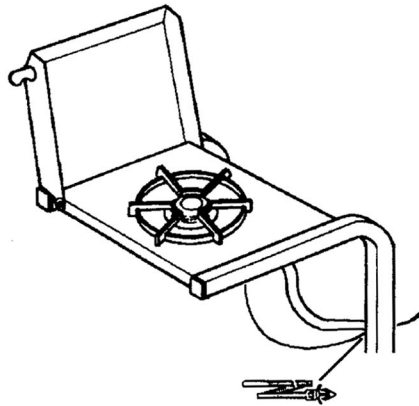
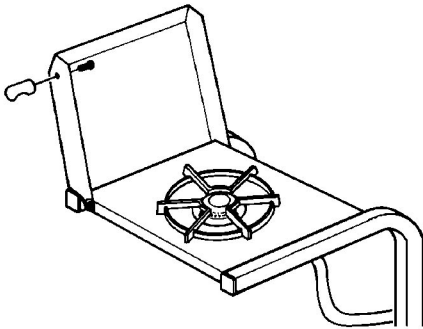

17

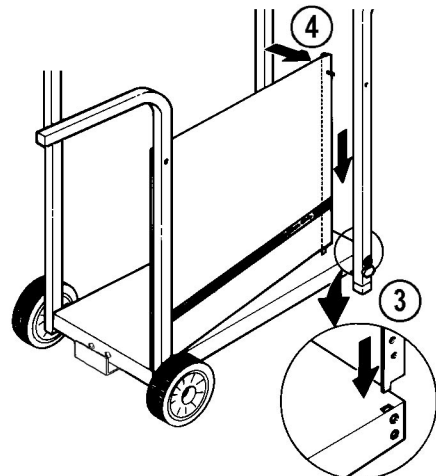
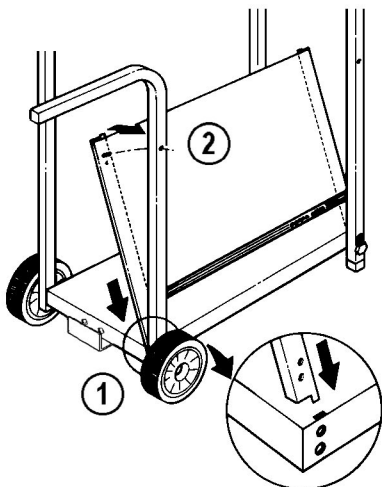
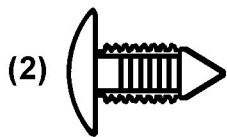



## PARTS LIST / LISTE DES PIECES

**KEY**

<u>NO.</u>	<u>ITEM #</u>	<u>DESCRIPTION</u>	<u>DESCRIPTION</u>	<u>202</u>	<u>301</u>	<u>322</u>	<u>370</u>	<u>395</u>	<u>441</u>	<u>452</u>	<u>456</u>	<u>464</u>	<u>467</u>
					<u>302</u>					<u>453</u>	<u>457</u>		<u>468</u>
36	10184-T411	SUPPORT- CASTING – R	SUPPORT DROIT DU FOYER	1	1	1	1	1	1	1	1	1	1
37	S21345	PLUG	EMBOUT DE JAMBE	•	•	2	•	2	•	•	•	2	2
39	10956-E401	BRACE – UPPER REAR	SUPPORT ARRIERE	1	1	1	1	1	•	•	•	•	•
	10956-E501	BRACE – UPPER REAR	SUPPORT ARRIERE	•	•	•	•	•	1	1	1	1	1
40	S17346	SHELF – LOWER	TABLETTE INFERIEURE	1	1	1	1	1	•	•	•	•	•
	S17347	SHELF – LOWER	TABLETTE INFERIEURE	•	•	•	•	•	1	1	1	1	1
46	S17106	BRACKET – CYLINDER LP	SUPPORT DU RESERVOIR (GAZ)	1	1	1	1	1	1	1	1	1	1
49	10711-T471	CONDI-BASKET	CONDI-BASKET	•	•	1	•	1	•	•	•	•	•
	10711-T571	CONDI-BASKET	CONDI-BASKET	•	•	•	•	•	•	1	1	1	1
50	10711-T451	SHELF - SIDE	PLANCHETTE LATERALE	2	2	1	2	1	•	•	•	•	•
	10711-K551	SHELF - SIDE	PLANCHETTE LATERALE	•	•	1	•	•	2	2	2	1	1
54	10088-34B	FRONT PANEL	PANNEAU AVANT	•	•	•	•	1	•	•	•	•	•
	10088-35B	FRONT PANEL	PANNEAU AVANT	•	•	•	•	•	•	•	1	1	1
	10088-65	FRONT PANEL	PANNEAU AVANT	•	•	•	•	•	•	•/1	•	•	•
55	10184-K631	FRONT PANEL BRACKET	SUPPORT POUR PANNEAU AVANT	•	•	•	•	2	•	•/2	2	2	2
56	10892-7	WHEEL	ROUE	2	2	2	2	2	2	2	2	2	2
57	10156-T40	HEAT SHIELD	ECRAN THERMIQUE	1	1	1	1	1	•	•	•	•	•
	10156-T55	HEAT SHIELD	ECRAN THERMIQUE	•	•	•	•	•	1	1	1	1	1
74	Y-6616	BOLT	BOULON	2	2	2	2	2	2	2	2	2	2
75	10338-145	HANDLE	POIGNEE	1	2	2	2	2	2	2	2	2	2
76	10239-6	WASHER - HANDLE	RONDELLE DE LA POIGNEE	1	2	2	2	2	2	2	2	2	2
77	S15111	GREASE CUP HOLDER	PORTE CONTENANT A GRAISSE	1	1	1	1	1	1	1	1	1	1
78	S21346	PLUG	EMBOUT DE JAMBE	2	2	2	2	2	2	2	2	2	2
81	Y-11560	SCREW - 1/4:20 X 1-1/2	VIS - 1/4:20 X 1-1/2	12	12	12	12	12	12	12	12	12	12
82	S21015	BOLT - 1/4:20 X 1	BOULON - 1/4:20 X 1	4	4	4	4	4	4	4	4	4	4
83	S21141	BOLT - 1/4:20 X 5/8	BOULON - 1/4:20 X 5/8	1	1	1	1	1	1	1	1	1	1
85	S21255	WASHER	RONDELLE	1	1	1	1	1	1	1	1	1	1
86	Y-12656	PLUG - BUTTON	BOUCHON	•	•	•	•	2	•	•/2	2	2	2
87	Y-11793	NUT - 1/4	ECROU - 1/4	17	18	18	18	18	18	18	18	18	18
88	Y-11598	NUT WING - 1/4	ECROU PAPILLON - 1/4	1	1	1	1	1	1	1	1	1	1
91	Y-11968	BOLT - 3/8:16 X 1-3/4	BOULON - 3/8:16 X 1-3/4	2	2	2	2	2	2	2	2	2	2
94	Y-12285	NUT - 3/8	ECROU - 3/8	2	2	2	2	2	2	2	2	2	2
96	Y-29304	BOLT 10:24 X 3/8	BOULON 10:24 X 3/8	2	2	4	2	4	2	2	2	4	4
97	10240-13	WHEEL BOLT	ROUE BOULON	2	2	2	2	2	2	2	2	2	2
98	S21124	SCREW - 8 X 1/2	VIS - 8 X 1/2	10	10	11	10	11	10	10	10	11	11
100	S21084	SCREW - 14 X 3/4	VIS - 14 X 3/4	•	•	4	•	4	•	•	•	4	4
104	Y-12835	SCREW 6-32 X 1/4	VIS 6-32 X 1/4	•	•	2	•	2	•	•	•	2	2
108	10472-71-2	KNOB	BOUTON	•	•	1	•	1	•	•	•	1	1
109	S21562	PUSH MOUNT CABLE TIE	LIEN EN PLASTIQUE	•	•	1	•	1	•	•	•	1	1
110	10225-T09	GRID	GRILLE	•	•	1	•	1	•	•	•	1	1
111	10390-E10	SIDE BURNER	BRULEUR DE COTE	•	•	1	•	1	•	•	•	1	1
113	10342-T12	ELECTRODE - SB	ELECTRODE - BRULEUR DE COTE	•	•	1	•	1	•	•	•	1	1
114	10393-T401	COVER - SIDE BURER	COUVERCLE DE BRULEUR DE COTE	•	•	1	•	1	•	•	•	1	1
115	Y-12083	NUT 10:24	ECROU 10:24	•	•	2	•	2	•	•	•	2	2
116	Y-12848	SCREW 10:24 X 1/2	VIS 10:24 X 1/2	•	•	2	•	2	•	•	•	2	2
117	10393-T32	SHELF - SIDE BURNER	SUPPORT DE BRULEUR DE COTE	•	•	1	•	1	•	•	•	1	1

