

This Owner's Manual is provided and hosted by [Appliance Factory Parts](#).



HUNTINGTON 6781-87 Owner's Manual

[Shop genuine replacement parts for HUNTINGTON
6781-87](#)



[Find Your HUNTINGTON Grill Parts - Select From 154 Models](#)

----- Manual continues below part list -----

Available Replacement Parts for HUNTINGTON 6781-87

18013	LARGE PROBE HEAT INDICATOR
S21233	HITCH PIN CLIP +
S21255	WASHER 26 ID X 3/4 OD X 1/16 +
Y-11793	NUT HEX 1/4 20 JS500 +
Y-12646	SCREW PHCP SHL.8X1/2 TY-AB +
Y-12835	SCREW-PHCP 6-32X1/4 TY-F JS500
Y-29307	NUT HEX #10-24 JS500
Y-11230	HAIRPIN COTTER SIDE BURNER +
S21362	REAR BURNER SPRING
Y-11546	SCREW PHCP 1/4-20X5/8 INCH A04#A
Y-12855	SCREW PHCP 1/4-20X3/8UNC-2A + A04 #A
Y-11795	NUT LOCKING
S21124	SCREW PHCP #8 X 12 +
Y-29304	SCREW PHCP #10 24x3/8
Y-12220	S/B BUSHING SB 1.375 16 HEY
S21235	HINGE PIN W/HOLE
Y-11560	BOLT PHCP 1/4 20x1-1/2 TYC +
S21125	SCREW 8 X 3/8 PAN HEAD
S15263	ROTISSERIE BUSHING
S15299	WASHER COUNTERWEIGHT ROTIS
S15270	ROTISSERIE COUNTERWEIGHT ASSY
S15271	ROTISSERIE HANDLE +
S35094	SCREW #10-24 X 5/8
S21061	WING NUT STAMPED 10-24
Y-11987	BOLT CARRIAGE 1/4-20x1.25 UNC+
18433	OEM FLAV R WAVE - REGAL/IMPERIAL
Y-11231	LID BUMPER ROUND BLK
Y-12223	MAGNET SNAP IN - DOOR
Y-12222	MAGNET - DOOR
23000-253	SIDE BURNER LID IR SS

23000-271	SIDE BURNER BODY BASE
22009-901	GREASE PAN FORMED +
S21084	SCREW HEX WASHER HEAD #14x3/4
10342-E13	ELECTRODE W/WIRE
10342-T18	WIRE ELECTRODE S/B 600 +
20809-957	REAR BURNER TUBE ASSMBLY W/COMP. FITTING
10693-109	ORIFICE SPUD RB 1.09MM 5/16 32
S15245	ROTIS MOTOR-220V AC +
27006-91	HEAT SHIELD 625 GALVANIZED D
22006-991	WARMING RACK PORC COATED CI
29006-074	CONTROL ASSEMBLY LP 5V+SB+RB
27056-901	GREASE TRAY PORC FORMED 625
S15259	SPIT ROD 37 INCH CRS BRGHT NICKEL
10240-20	DOOR PIN TOP
10240-19	DOOR PIN BOTTOM
Y-12124	DOOR PIN CAP BOTTOM
29006-077	CONTROL ASSEMBLY NG 5V+SB+RB
21475-138	DOOR HANDLE RESIN
23009-608	SHELF STRAP RESIN W/SS STRIP +
23100-654	SIDE SHELF INSERT LHS 430SS +
11229	EXACT FIT CAST GRID - REGAL/IMPERIAL
10693-160	ORIFICE SPUD 1.60MM 5/16-32
21039-911	CASTER BRACKET BLACK
Y-12127	DOOR CLIP UPPER
Y-29310	SCREW #10-24 3/4 TRUSS QU
21036-991	GREASE RAIL 550/625
27906-354	REAR BURNER TUBULAR W/DEFLECTOR
10342-251	Igniter, 5 port, aftermarket
82316-021	FIREBOX 625 HOOD PANEL PORC
20005-000	HARDWARE BAG STICK & CHAIN SS
25070-90	SWITCH - OVEN LIGHT
10892-23	CASTER RUBBER 3 INCH W/PLATE
44089-60	NAMEPLATE PATRIOT

Y-99101	DRAWER SLIDE SET LHS & RHS 16 INCH
18633	BURNER - REGAL/IMPERIAL
25080-90	TRANSFORMER ASSY GPB
22006-494	CONTROL COVER 5V SB RB W/ LS HOLE
52016-903	COLLECTOR BOX ASSEMBLY 625
80012	regulator and hose READ ADD. INFO
57039-901	ROTISSERIE BRACKET BLK
Y-12865	SCREW 1/4 X 20X1/2 TYPE-C PHCP
50502	HEAVY DUTY MEAT FORKS
10390-R81A	SIDE BURNER ASSY
23009-99	SIDE BURNER TRIVET CI
17000	CONTROL KNOB - SMALL BLACK
17010	CONTROL KNOB RESIN LRG BLACK
Y-11544S	SCREW - BURNER #10-24 X 3/8
10111-K45	HOSE 3/8 INCH ASSEMBLY NG 10 FOOT +
Y-11990	NUT HEX BRASS 3/8 27 RB LINE
22001-168	CONTROL KNOB BEZEL SML
22002-268	CONTROL KNOB BEZEL LARGE
23101-613	SIDE SHELF - RIGHT SS430

HUNTINGTON™

REDDI-BILT BARBECUES

ASSEMBLY MANUAL & PARTS LIST

MANUEL DE MONTAGE & LISTE DE PIÈCES



HUNTINGTON™
PATRIOT 590
6781-84
6781-87

RETAIN FOR FUTURE REFERENCE

VEUILLEZ CONSERVER POUR REFERENCE ULTERIEURE

1-800-265-2150

info@omcbbq.com

Onward
MANUFACTURING COMPANY

SINCE 1906

1000 EAST MARKET STREET
HUNTINGTON, INDIANA, 46750, USA

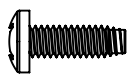
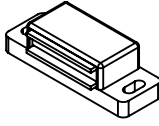

20084-E57 REV A 11/12

1

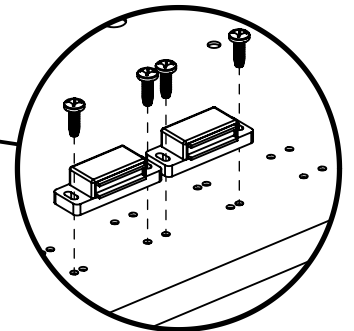
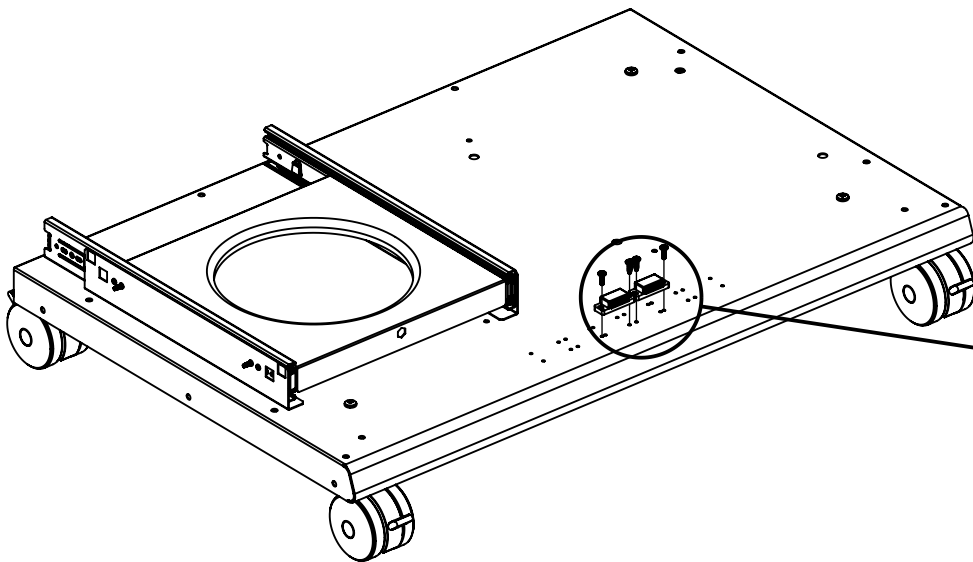
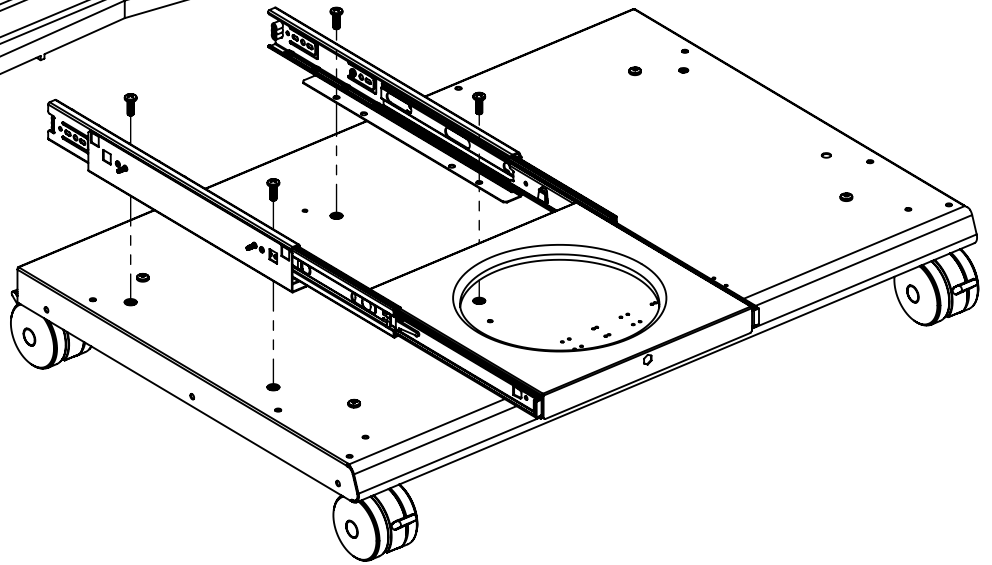
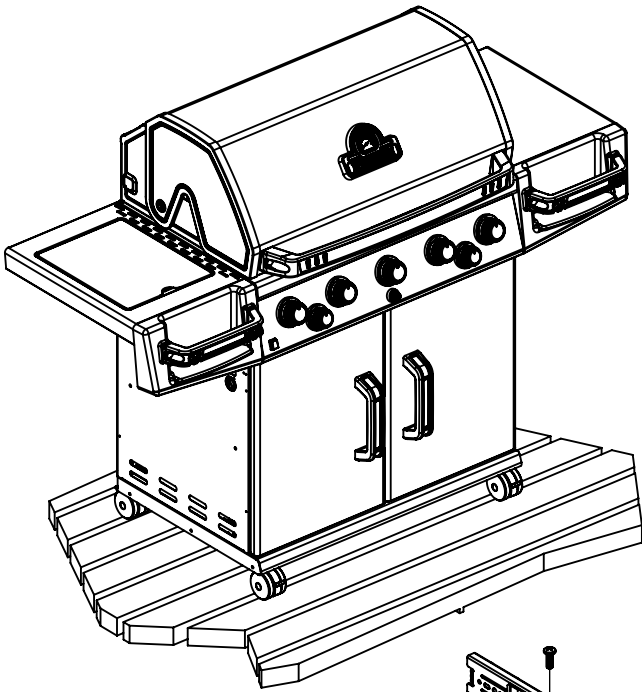
- (4)  (4)  (2) 



2

(4)  (4)  (2) 

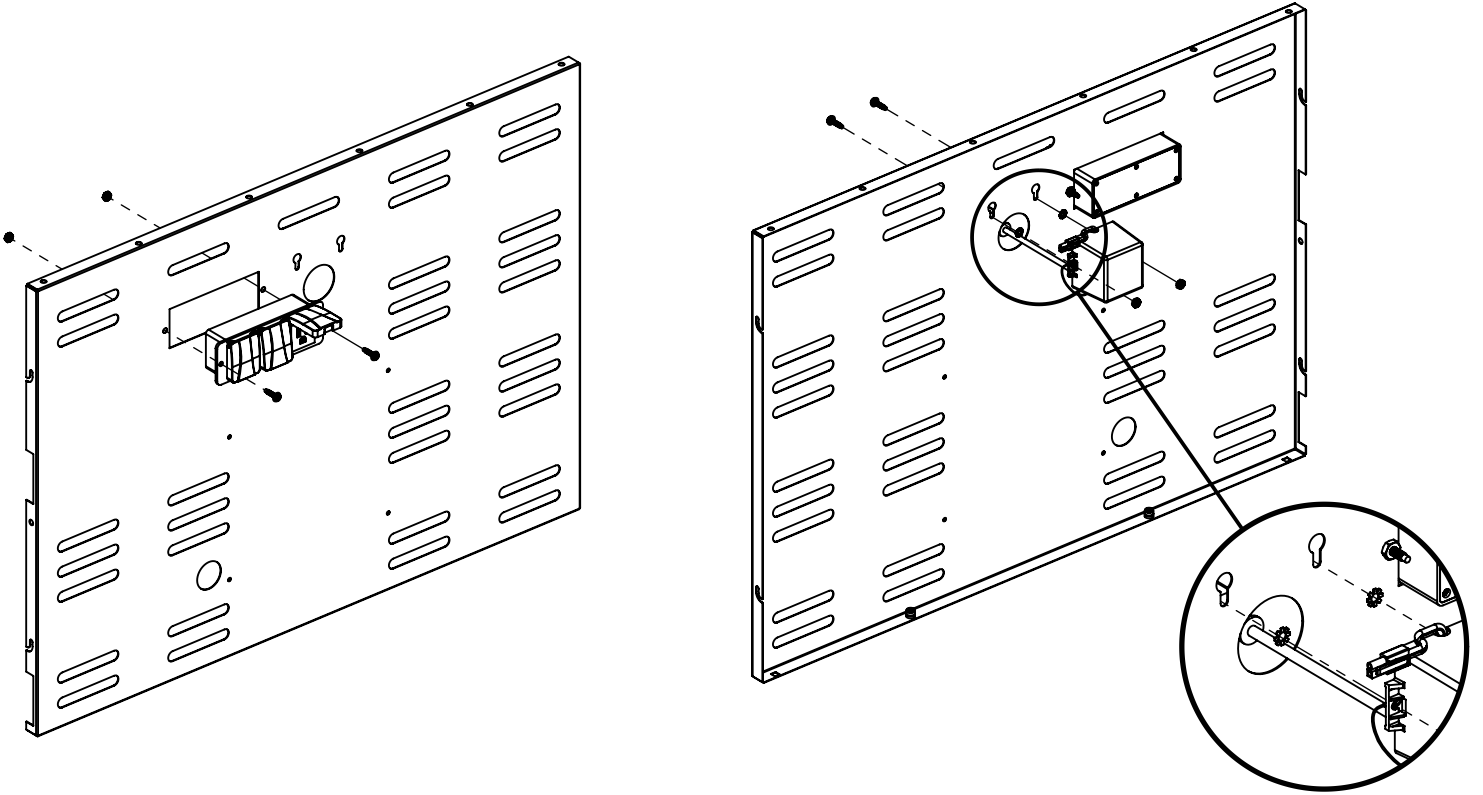

3

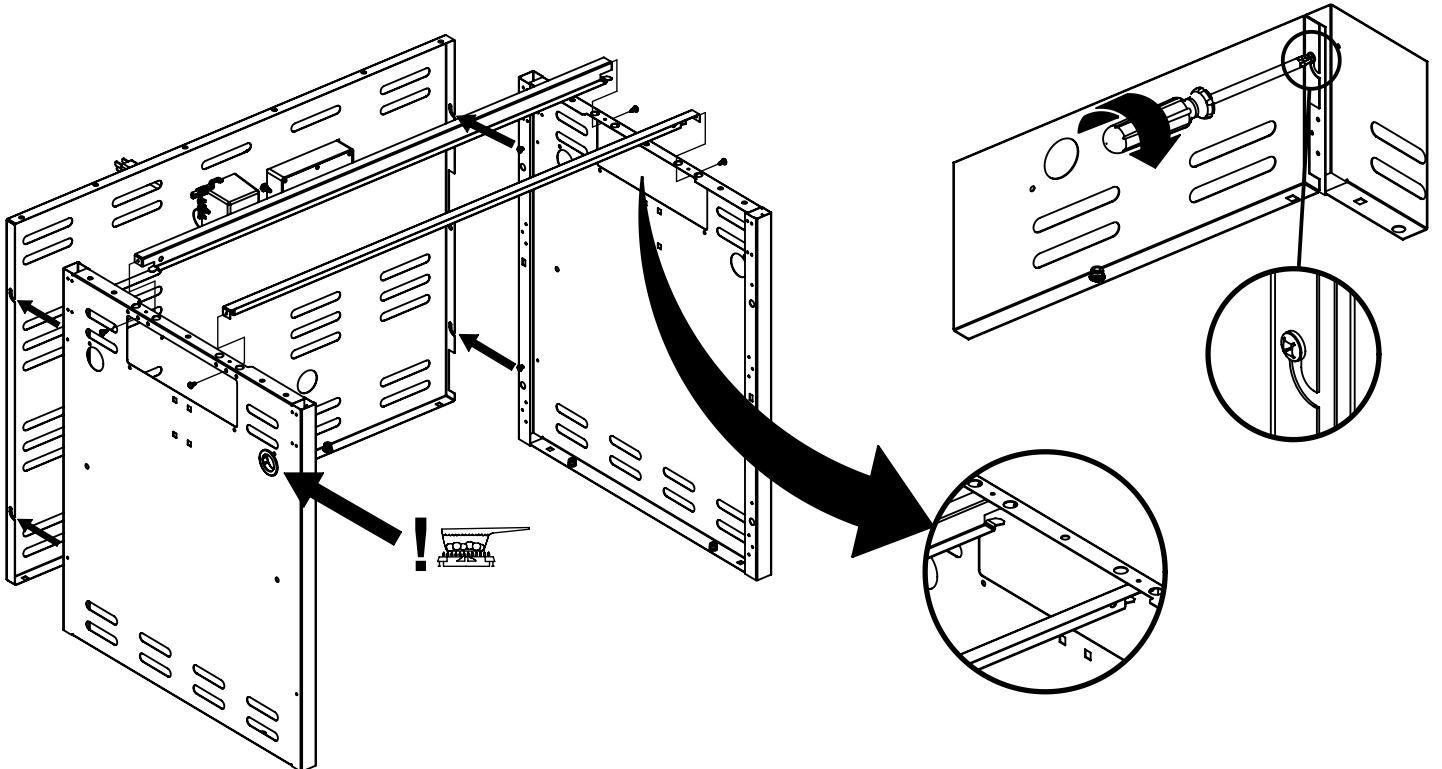

4

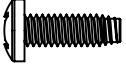
(2)  (2) 

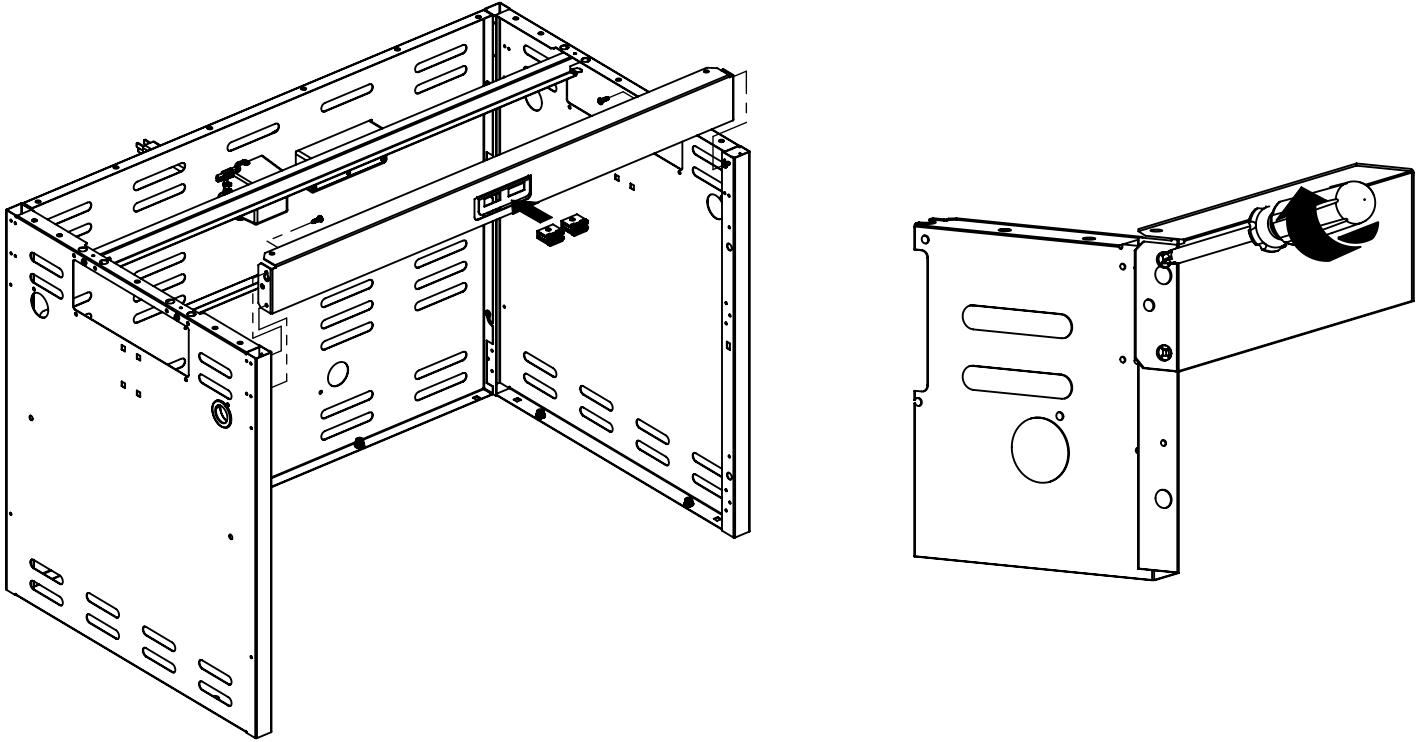

5

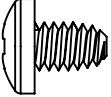
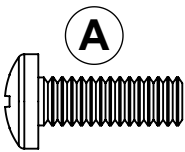
(4)  (2)  **A**

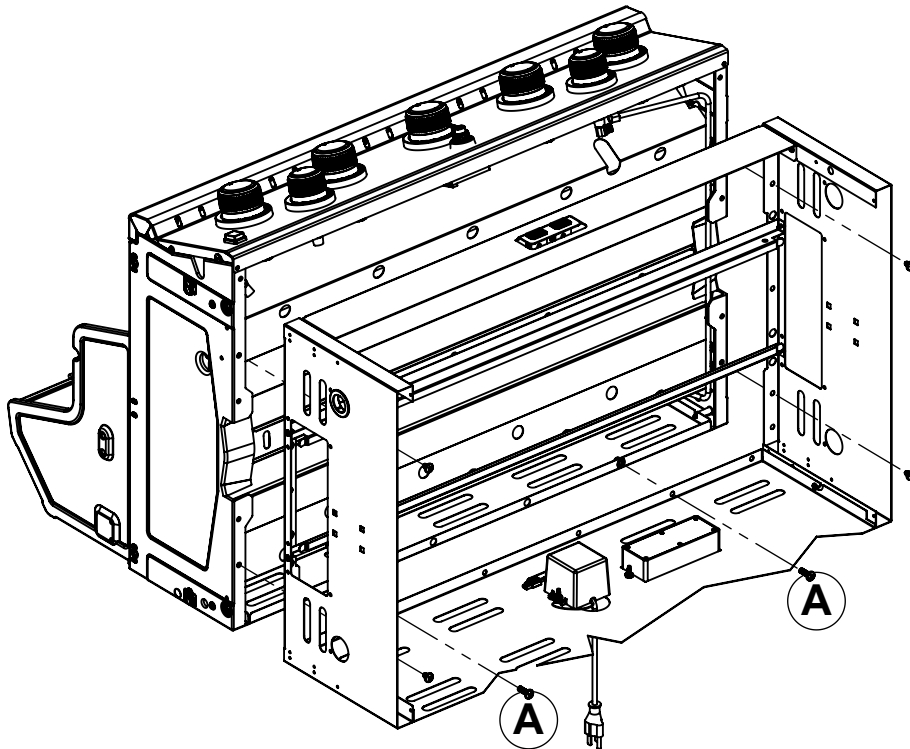

6

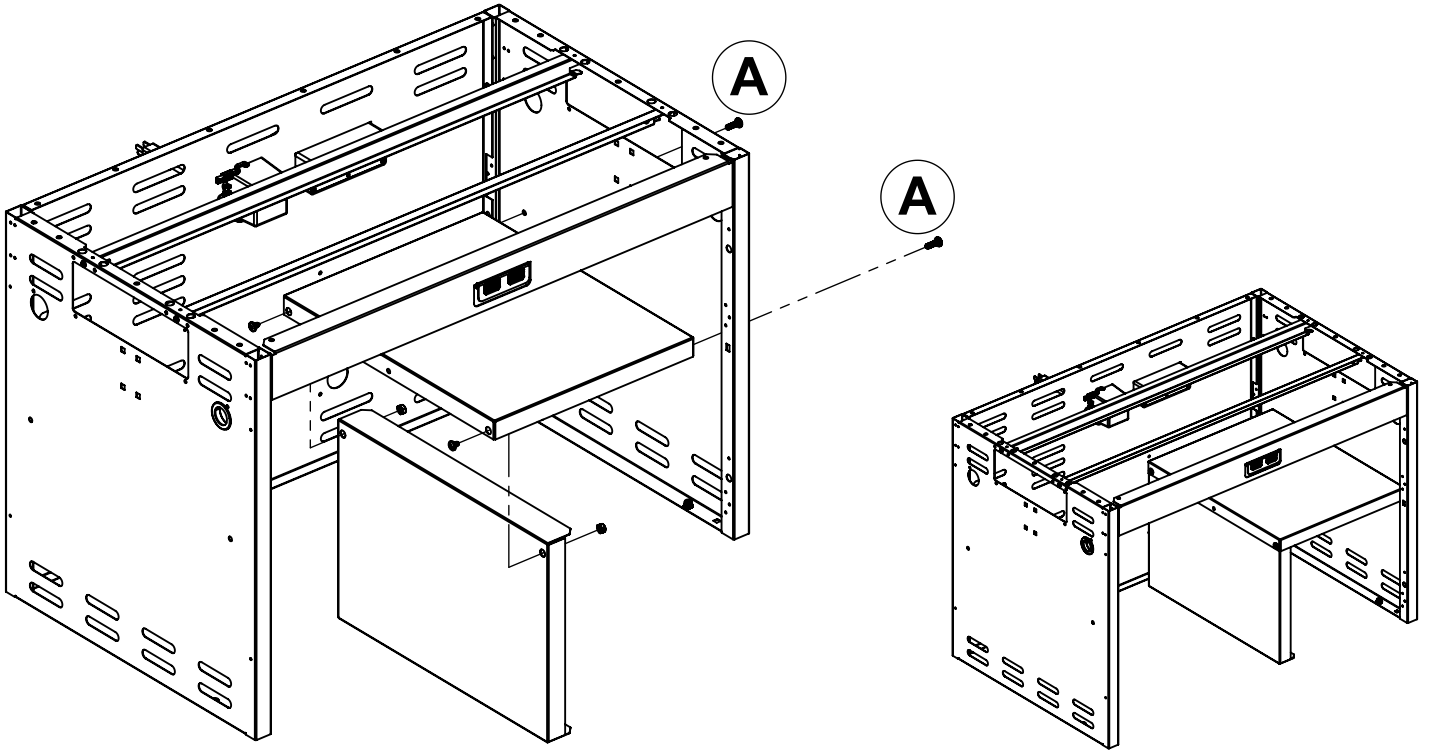
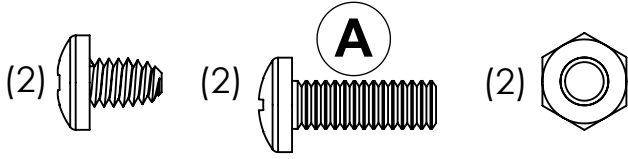

7

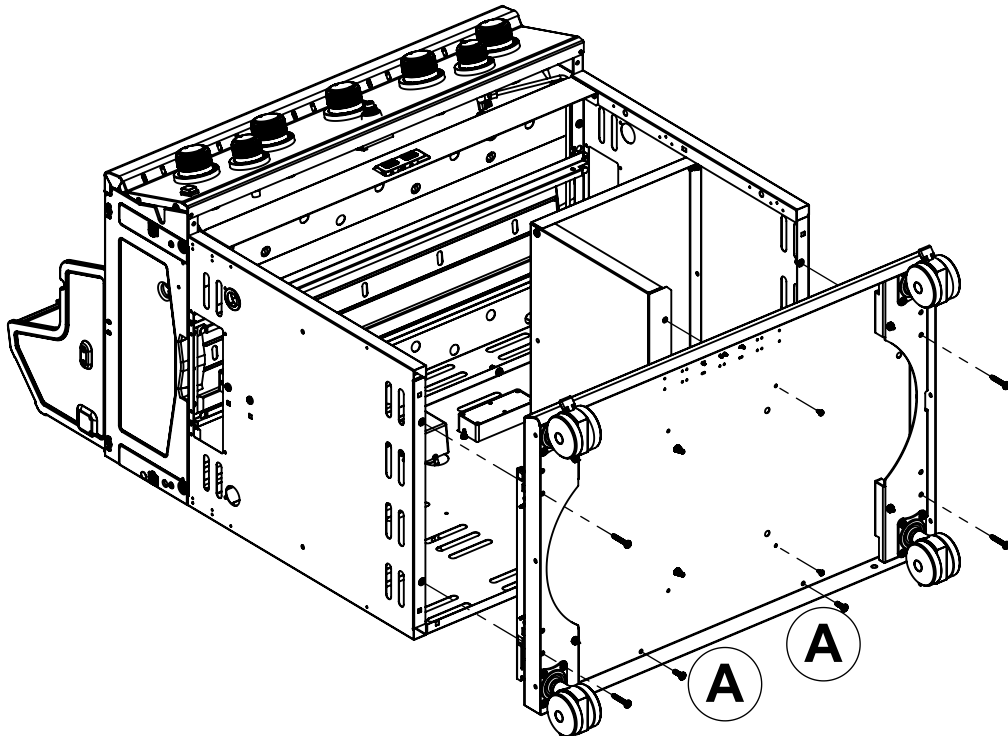
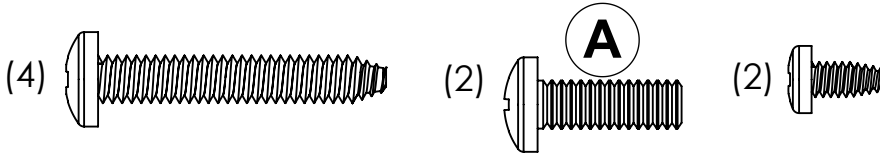

8

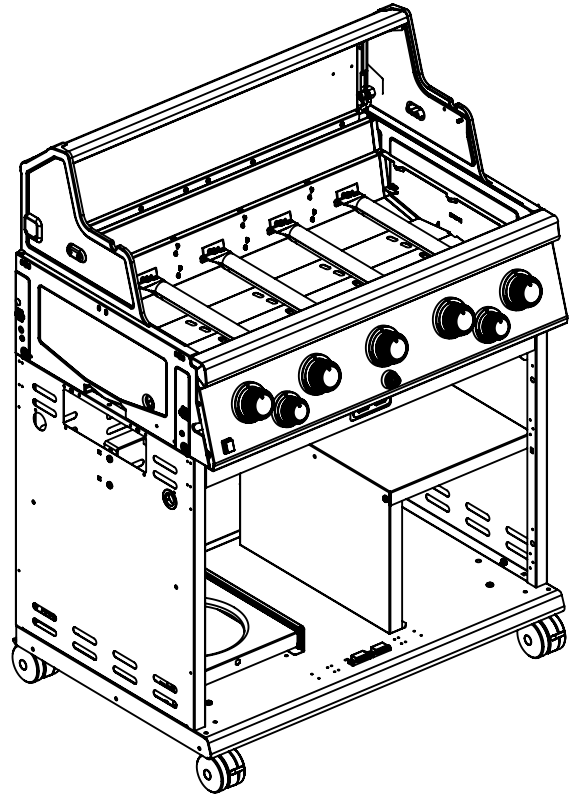
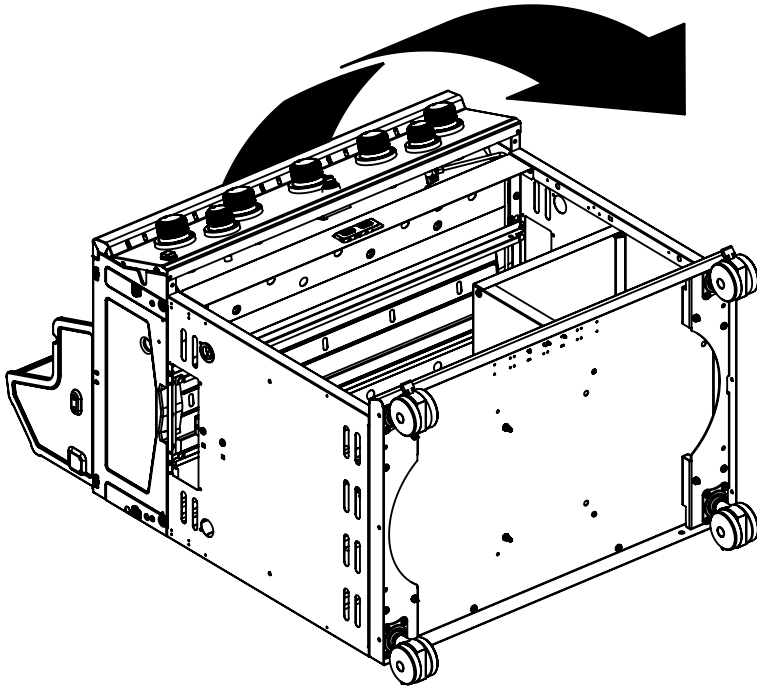

9

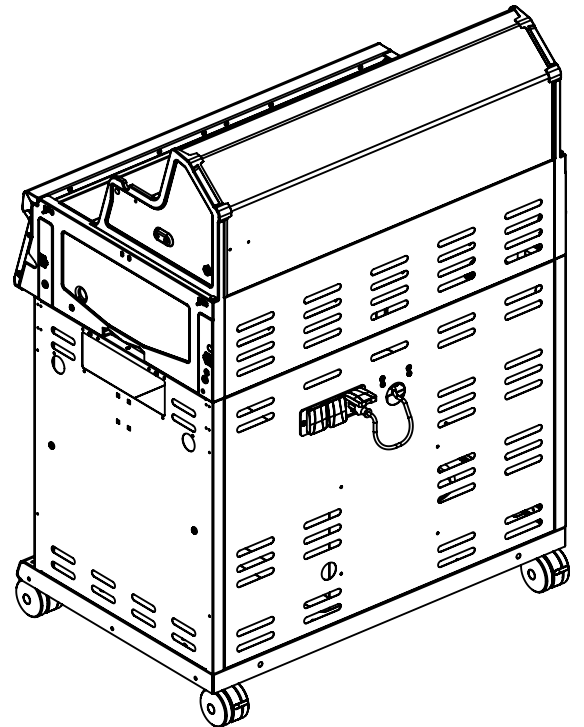
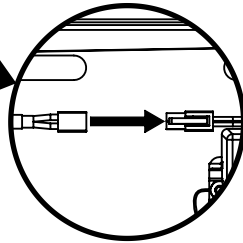
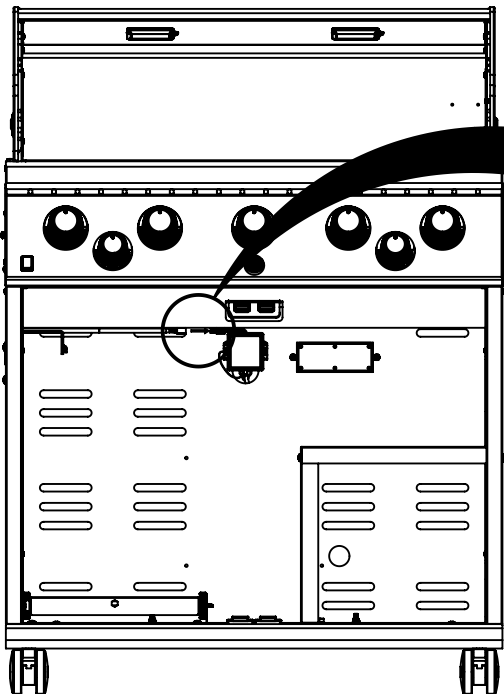

10

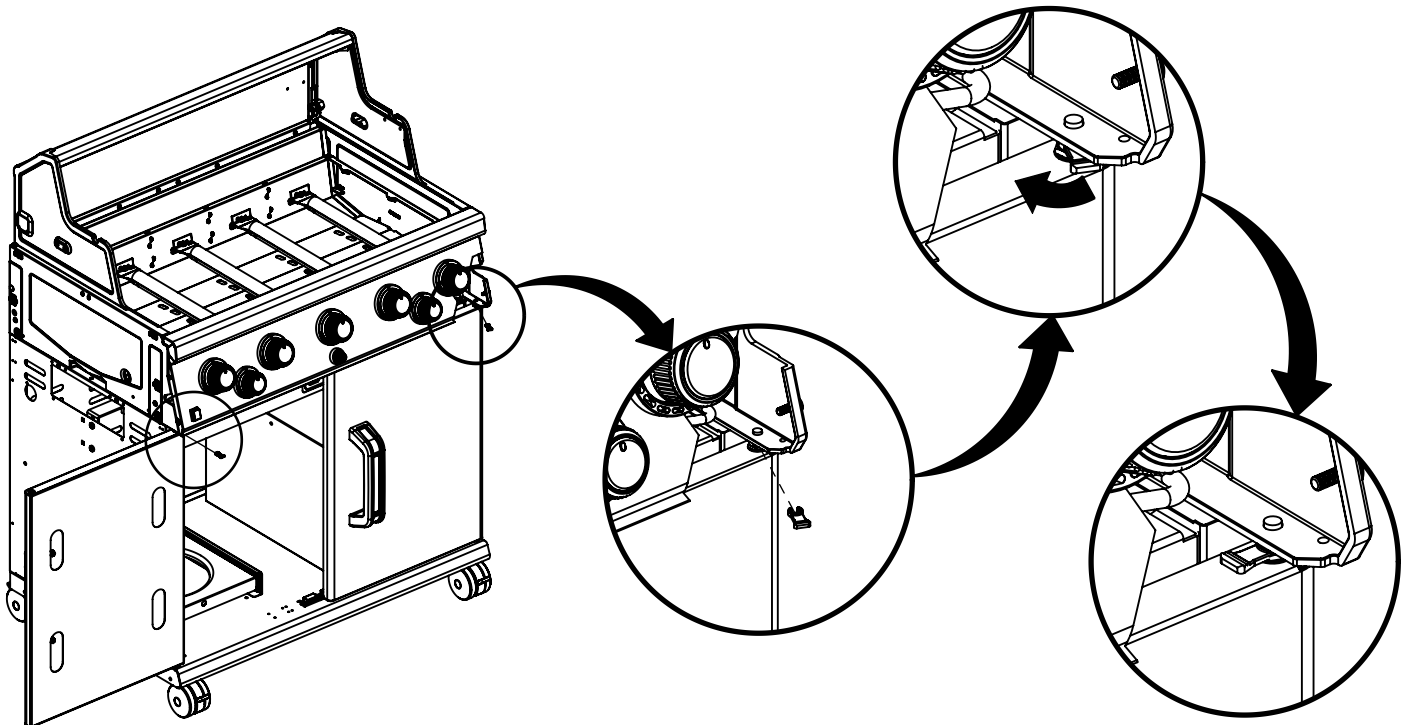
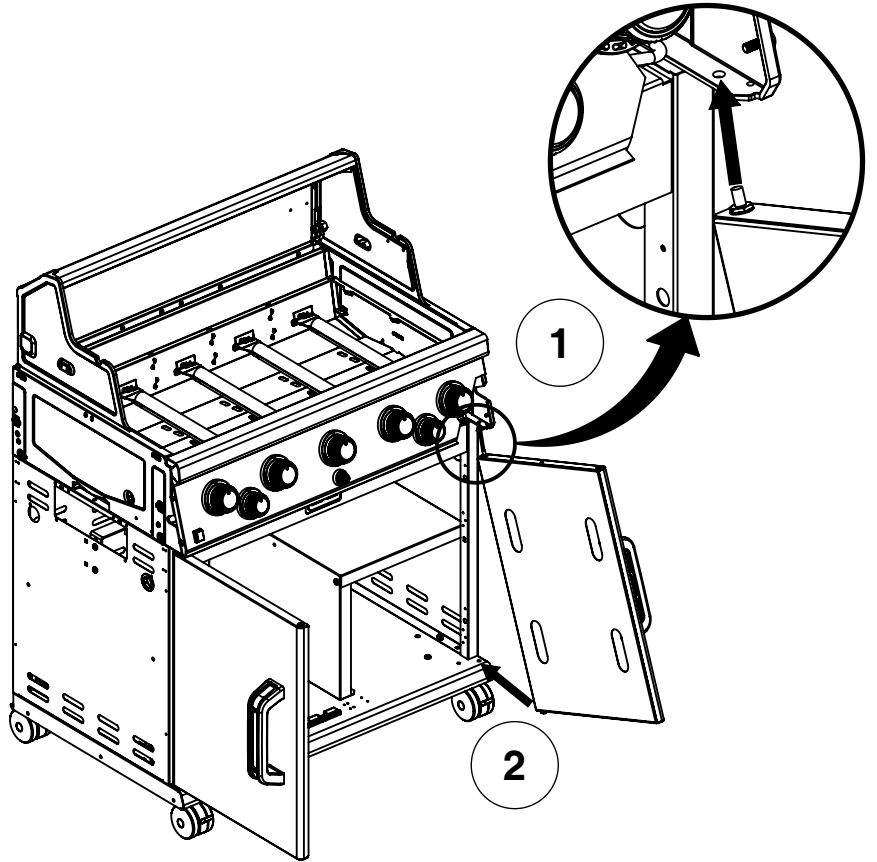
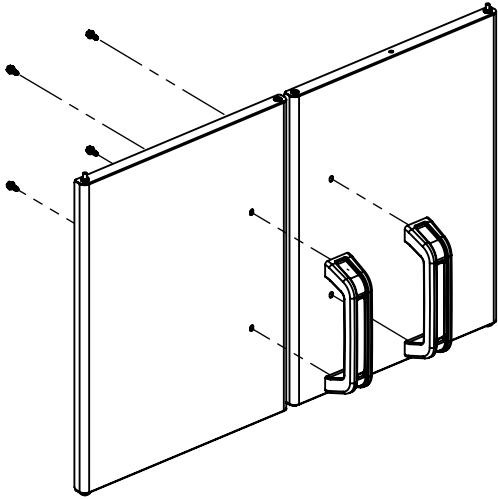

11

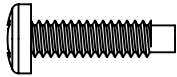
(2) 

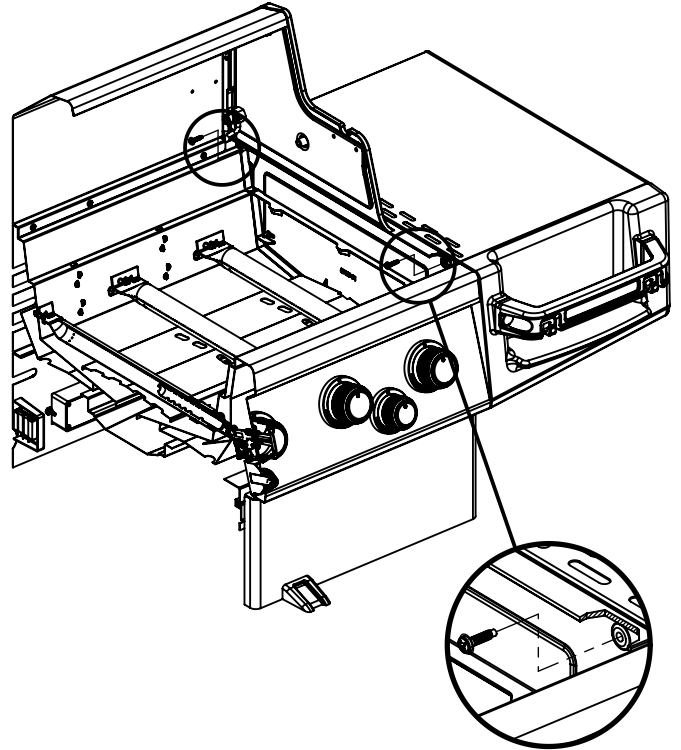
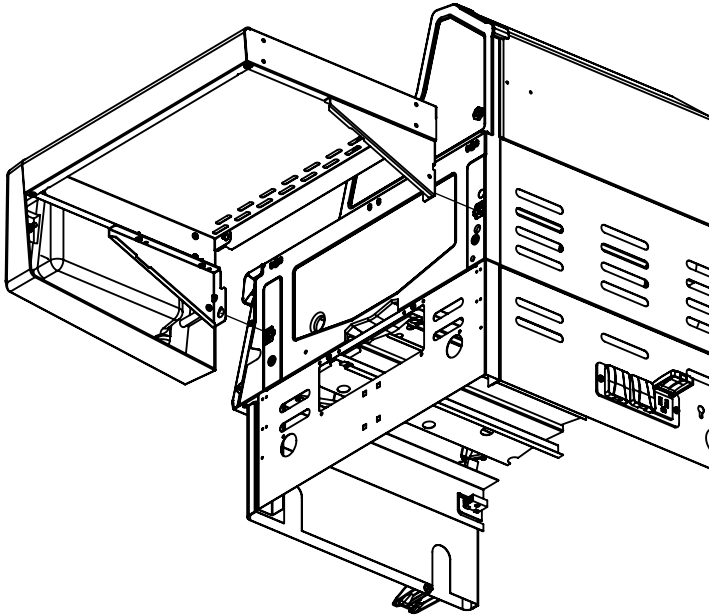

12

(2) 

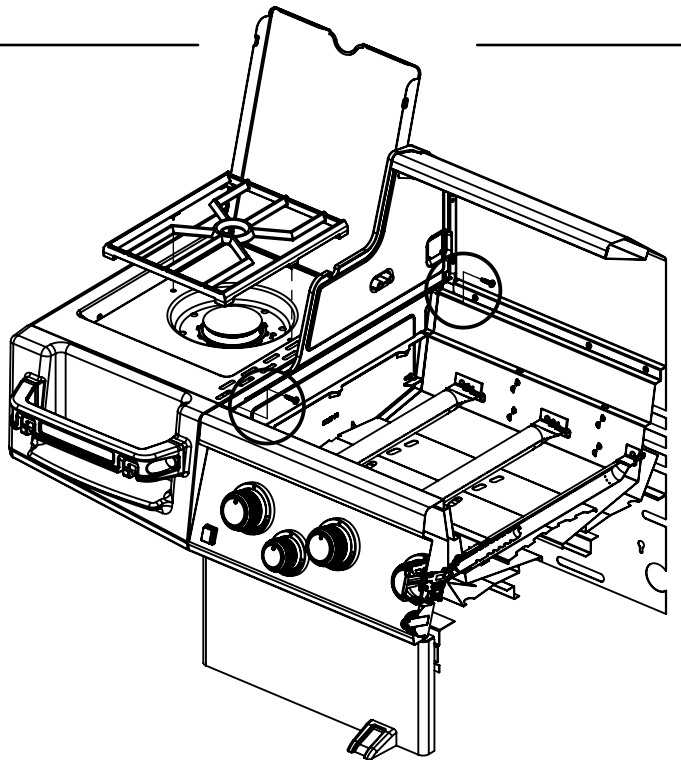
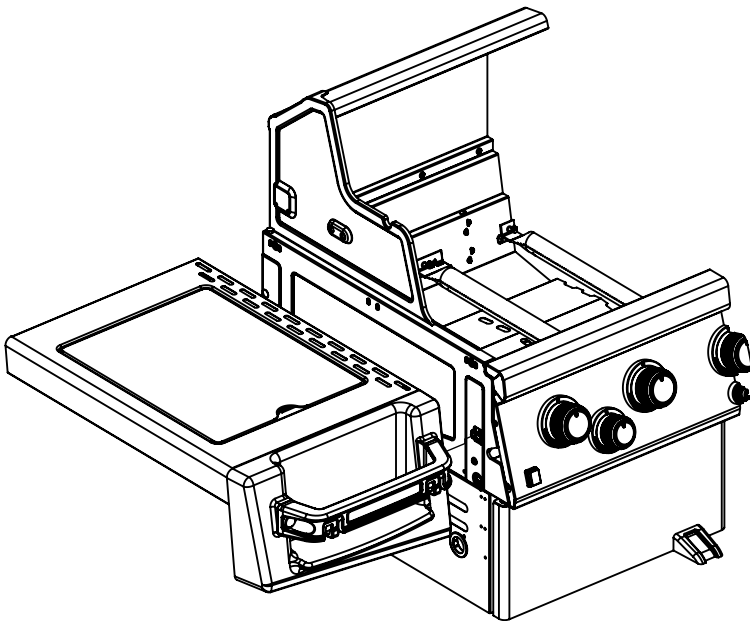

13

(1)

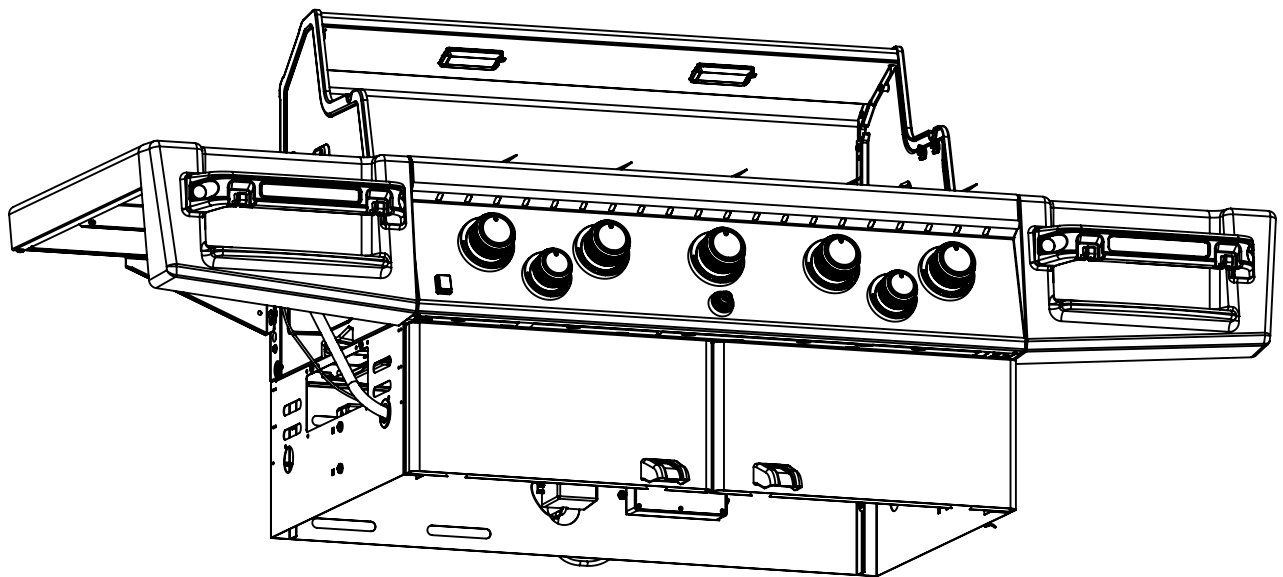
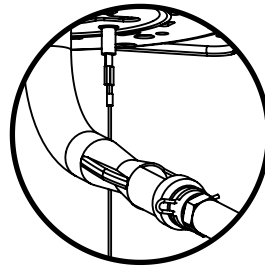
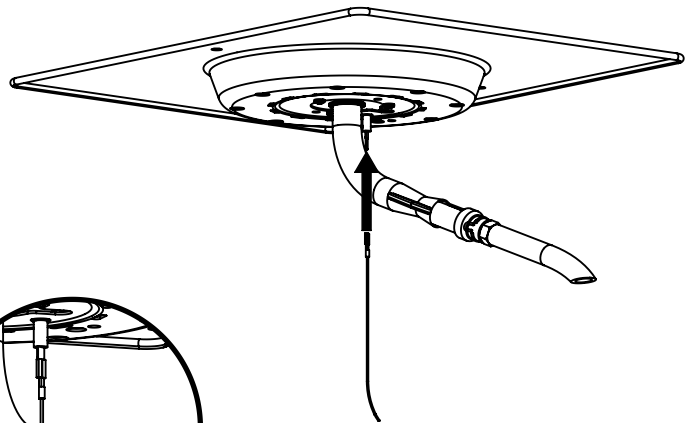
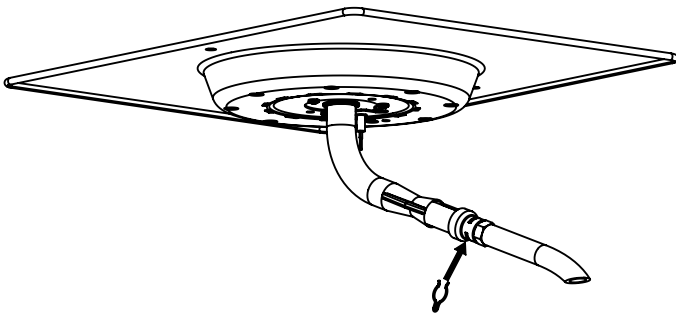
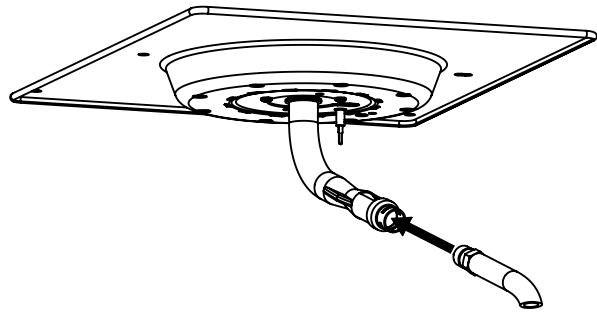
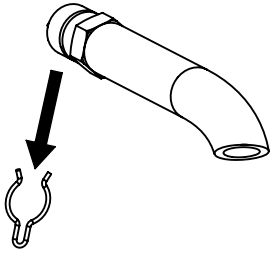
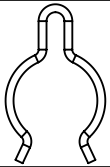

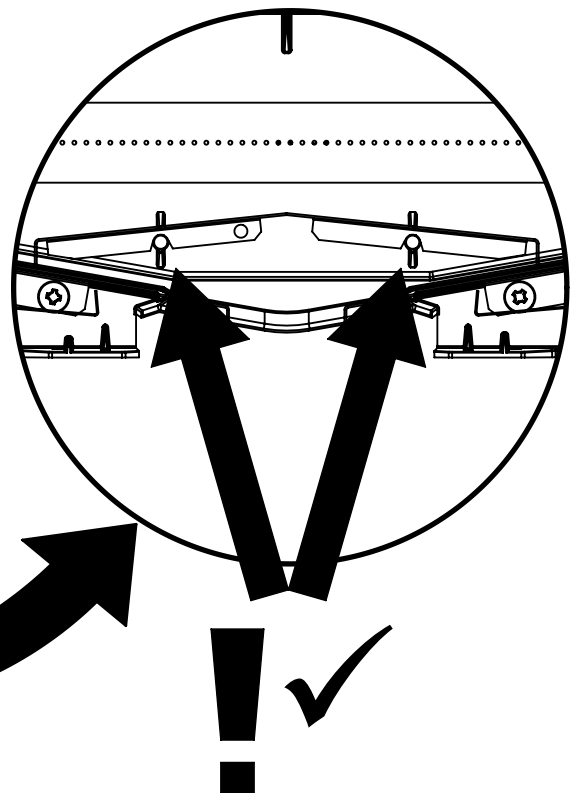
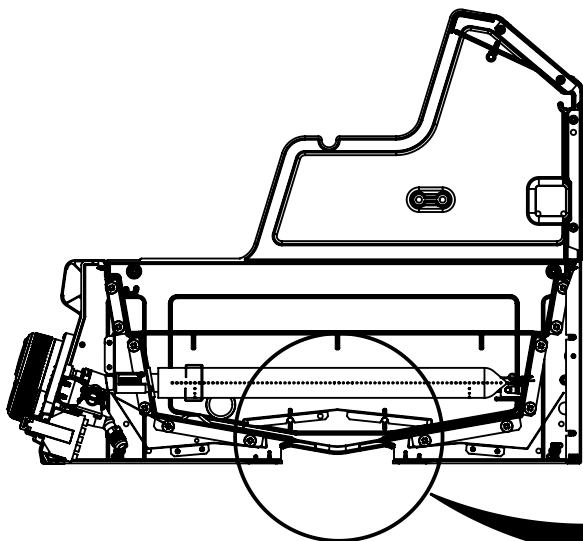
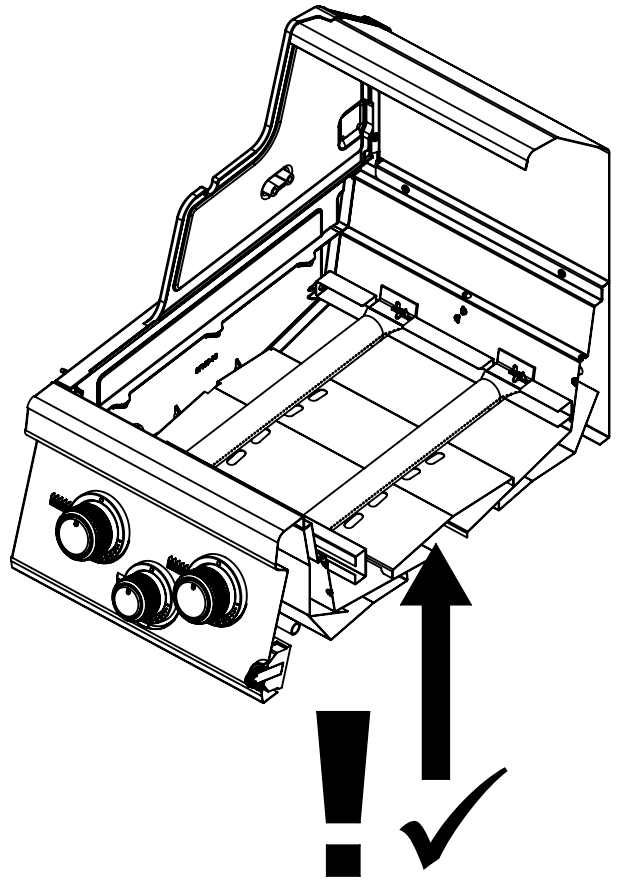
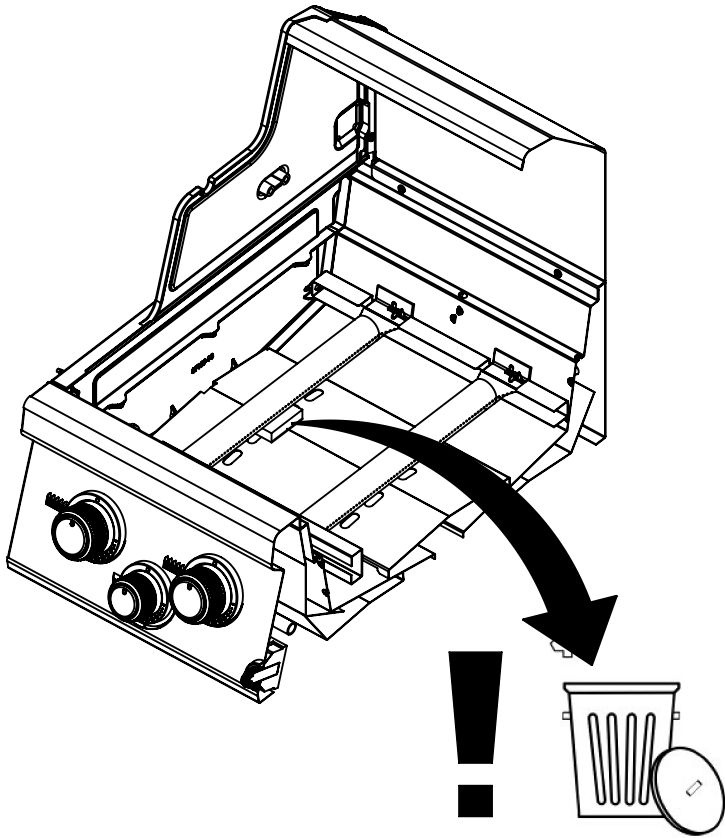

15

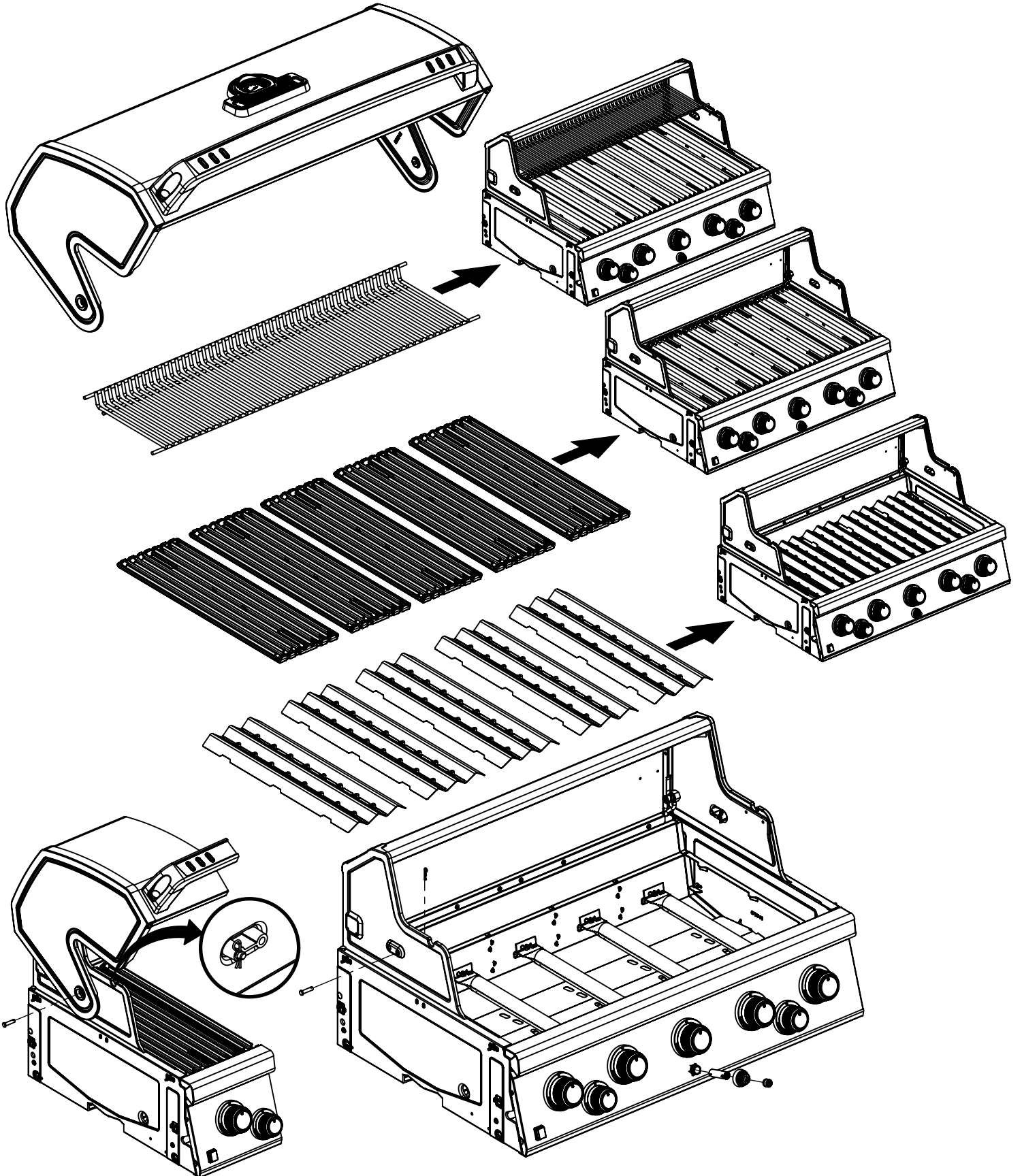
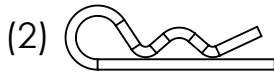
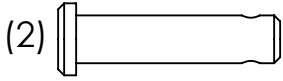

16

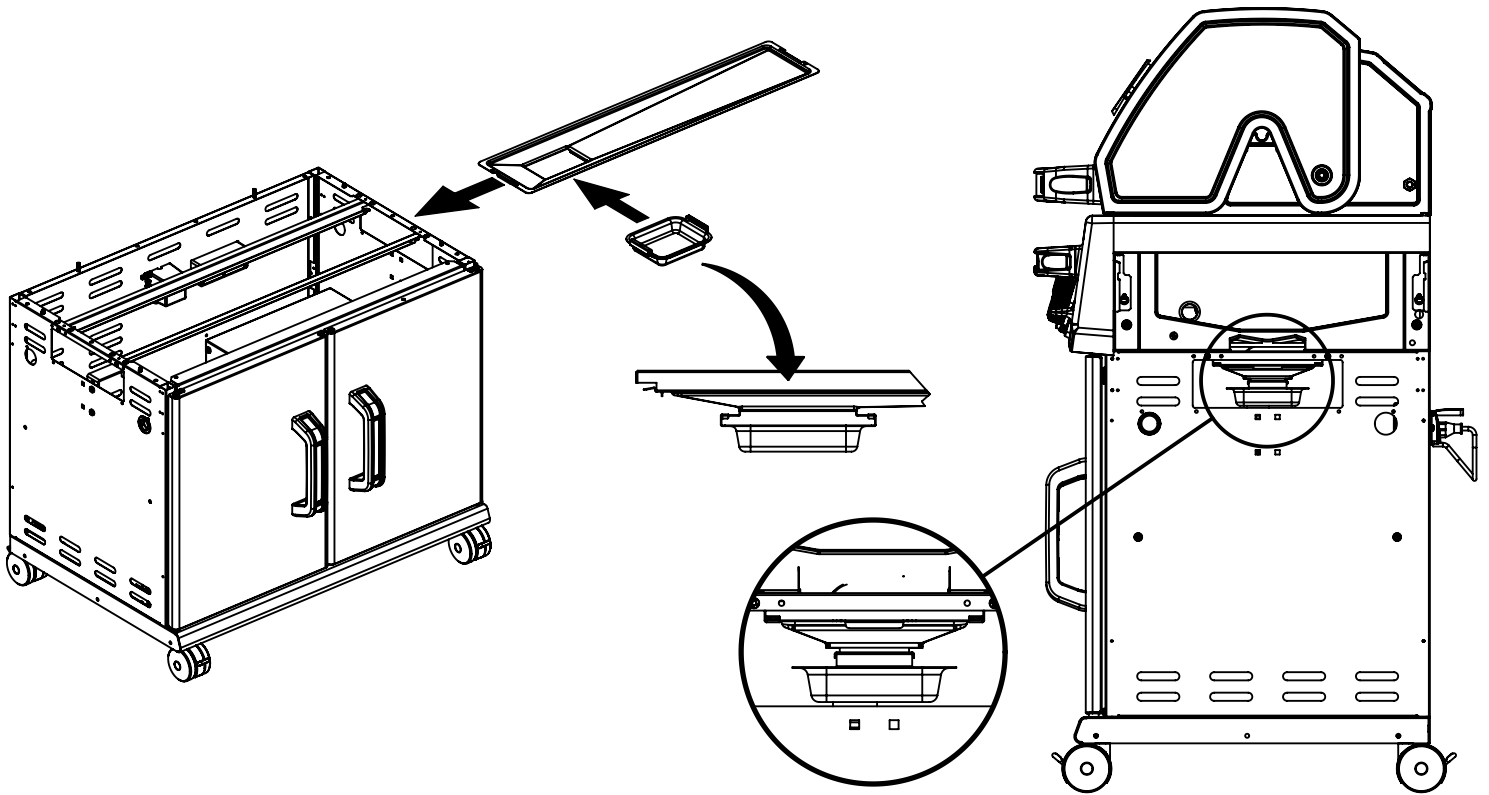

17

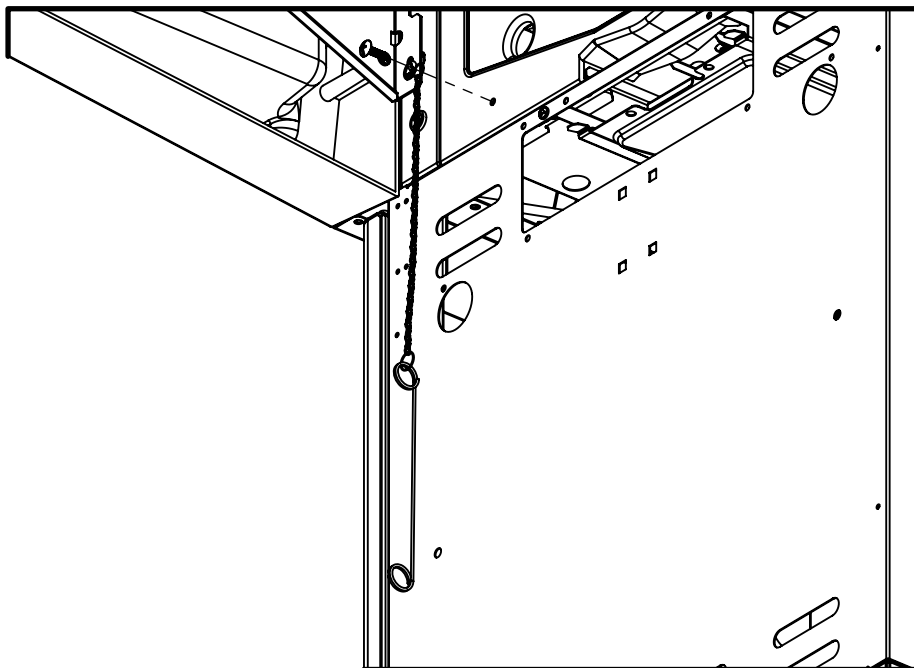
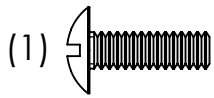

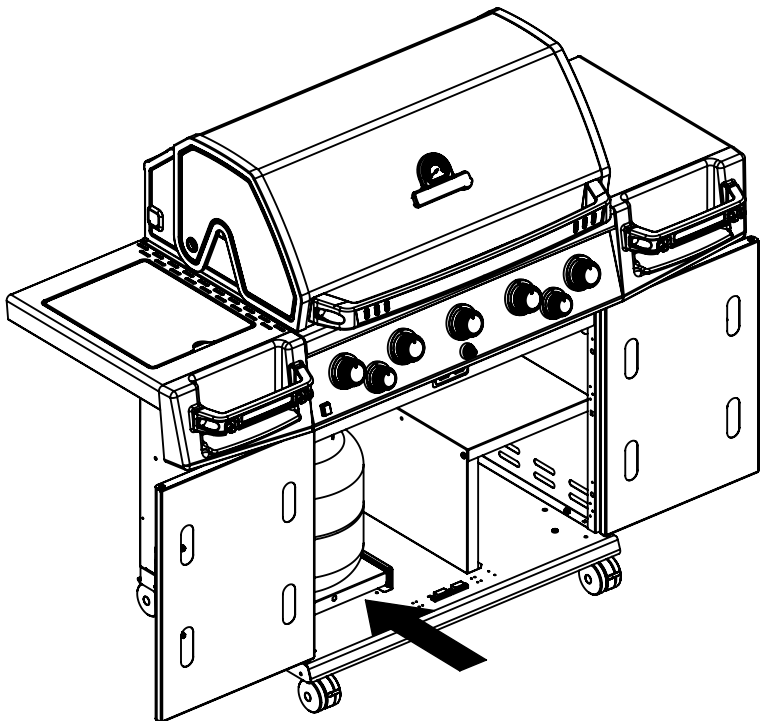
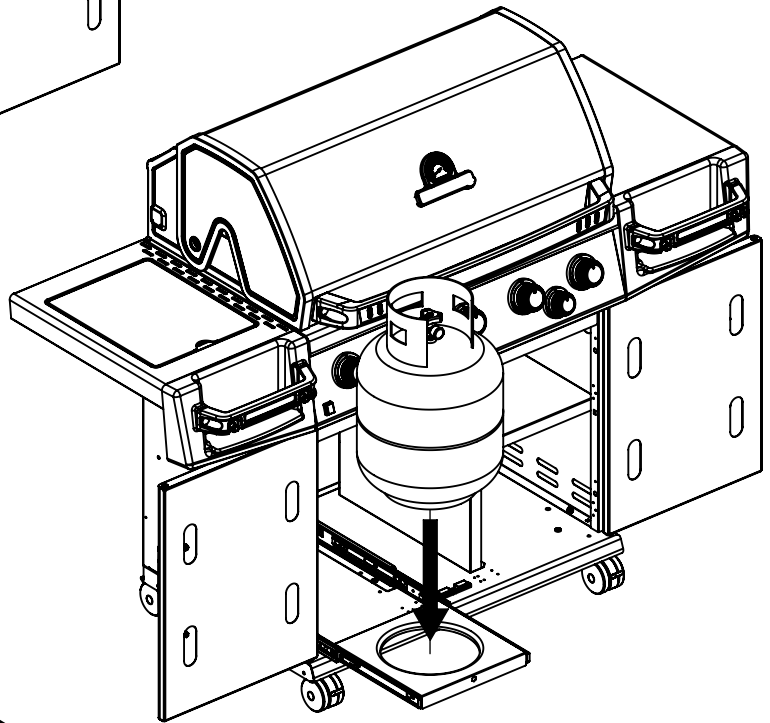
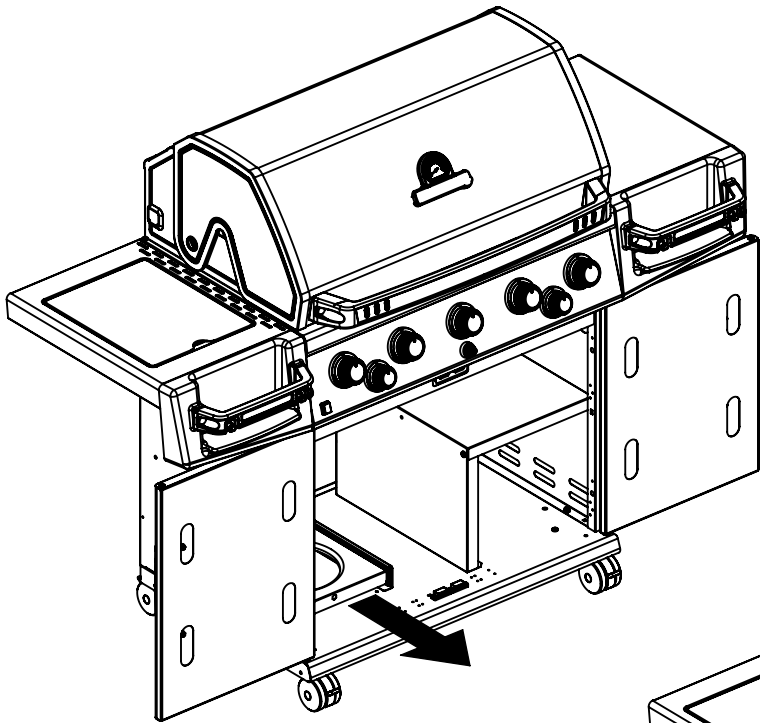

19

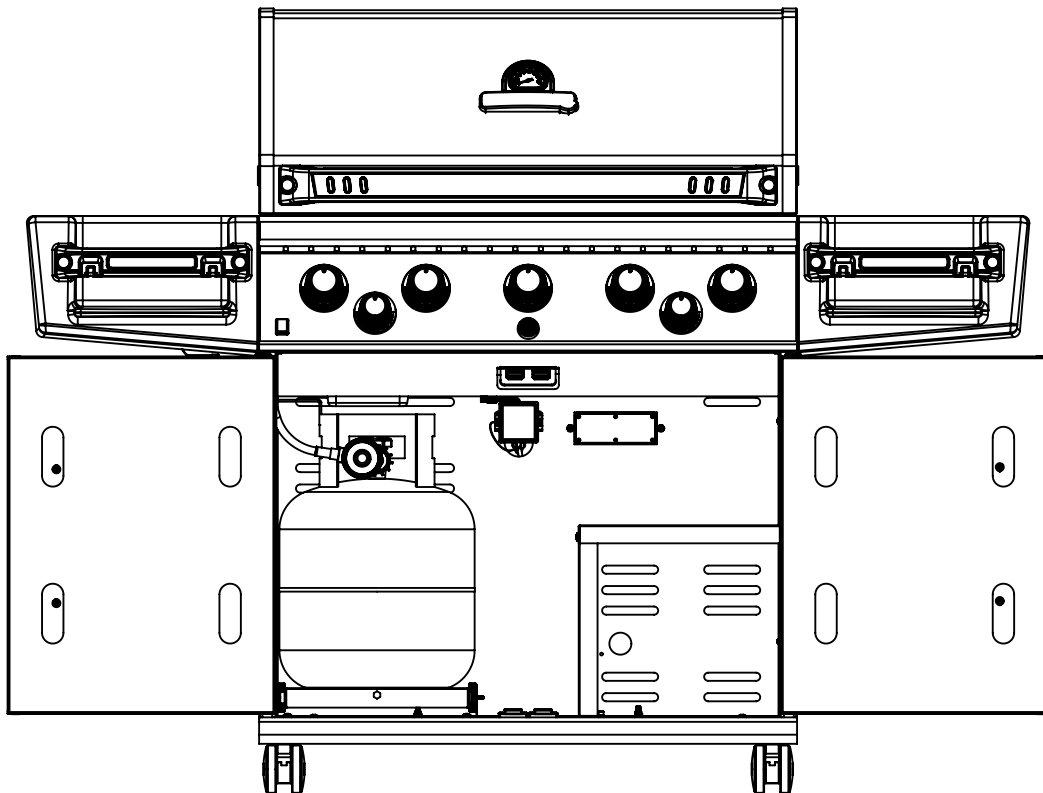
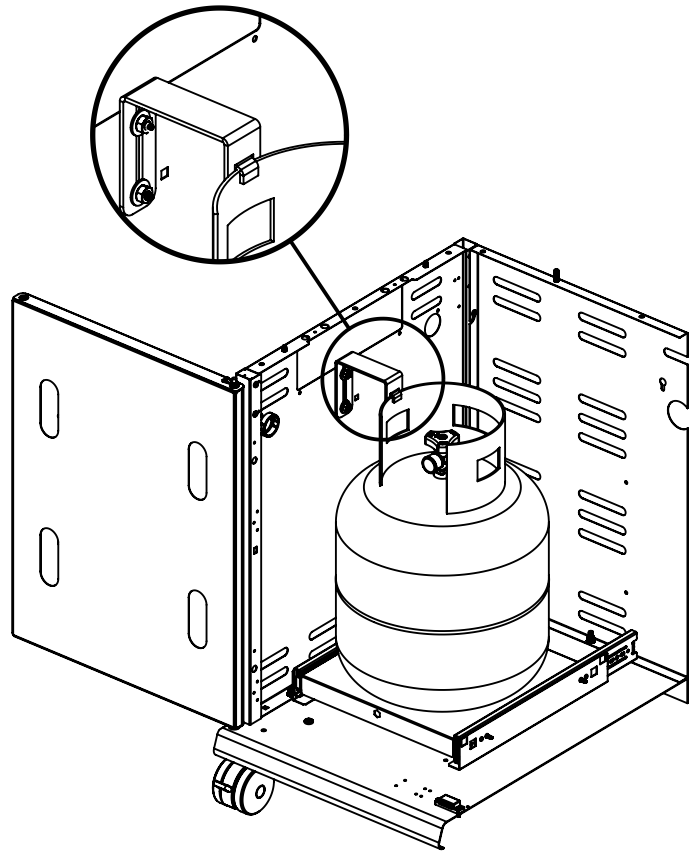
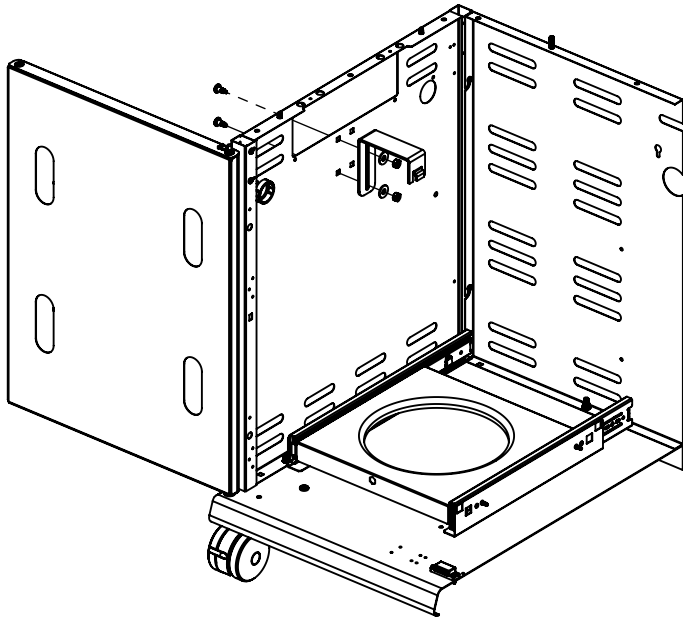
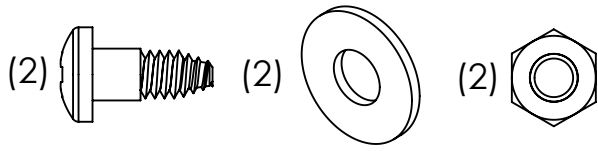

20

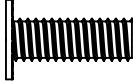
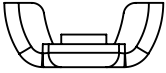
(2)  (2) 

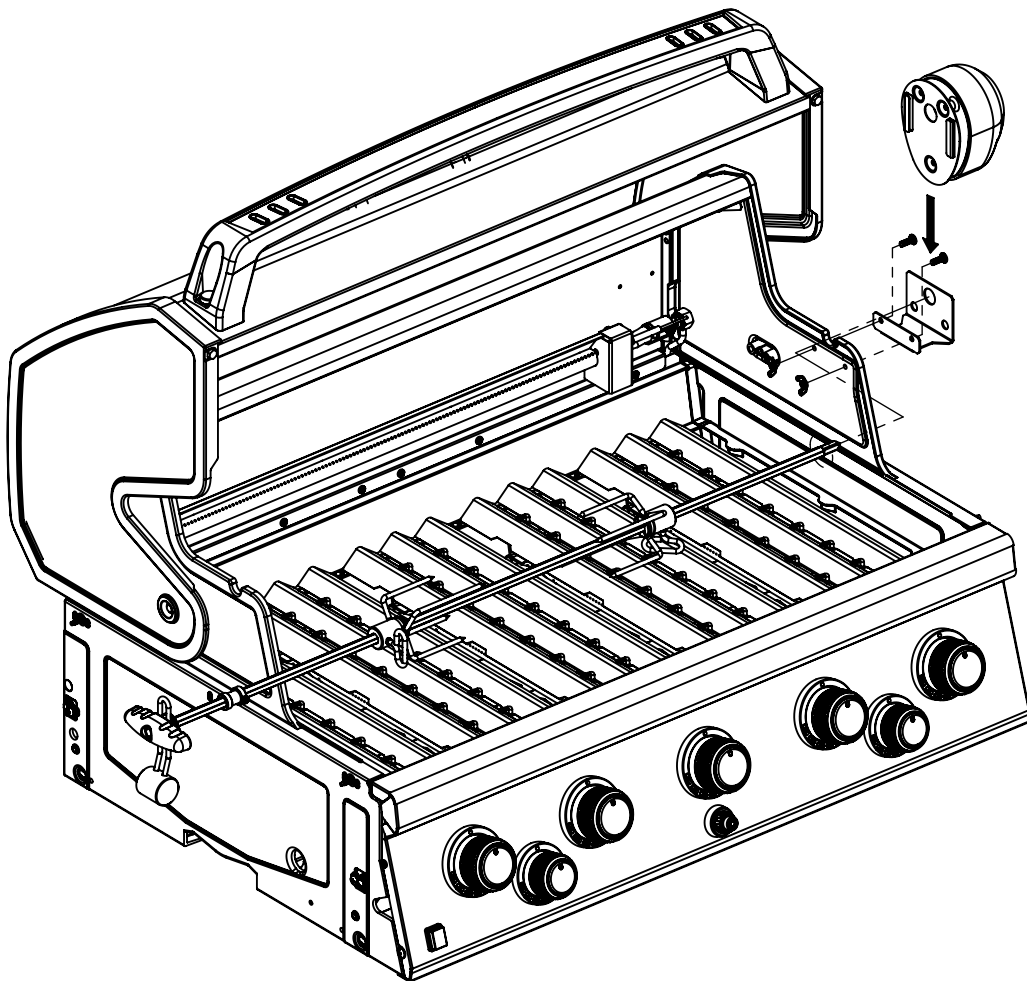
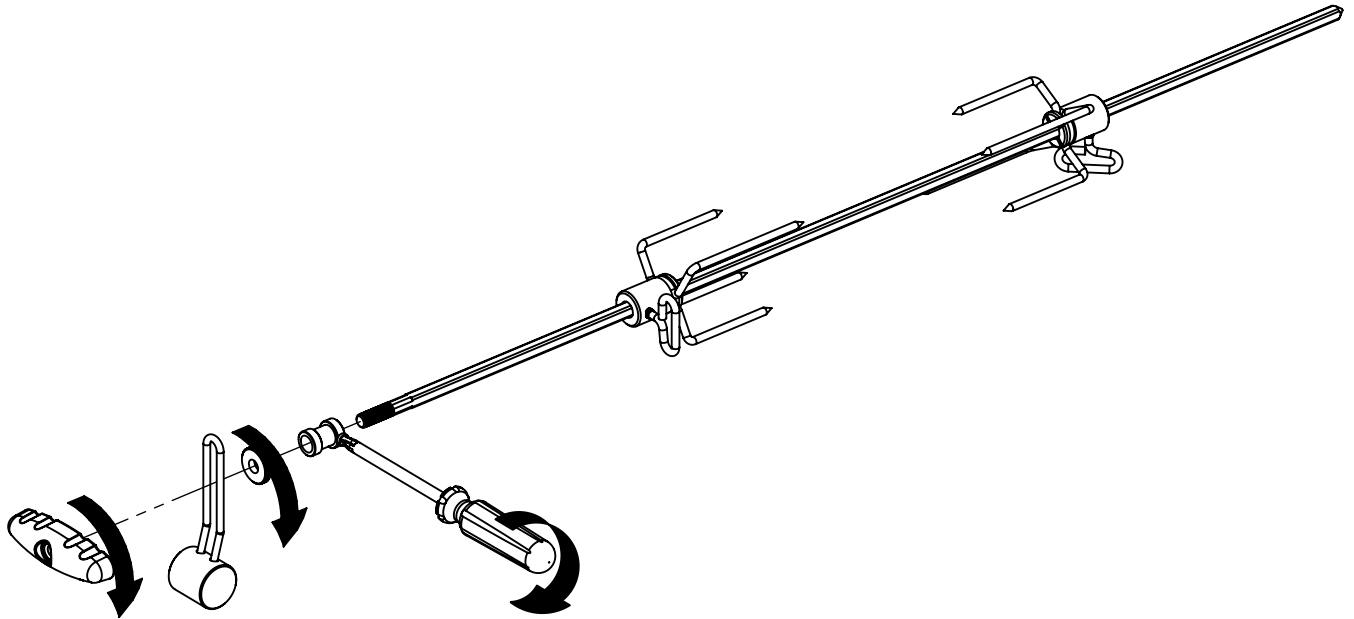

PARTS LIST / LISTE DES PIECES

KEY #	ITEM #	DESCRIPTION	DESCRIPTION	6781-84	6781-87
1	87109-931	PANEL - SIDE LEFT	PANNEAU - CÔTE GAUCHE	1	1
2	87109-911	PANEL - SIDE RIGHT	PANNEAU - CÔTE DROITE	1	1
3	27206-011	PANEL - FRONT INNER	PANNEAU FRONTAL ARRIERE	1	1
4	27206-921R	PANEL - INNER REAR	PANNEAU INTERIEUR ARRIERE	1	1
5	27246-904	GREASE SHIELD	PROTECTION CONTRE LA GRAISSE	1	1
6	27006-91	HEAT SHIELD	PROTECTION CONTRE LA CHALEUR	3	3
7	Y-11544	SCREW - BURNER	VIS - BRÛLEUR	5	5
10	82306-021R	PANEL - REAR COOKBOX	PANNEAU - RECIPIENT	1	1
12	82316-021	PANEL - HOOD	PANNEAU DE LA CUVE	1	1
13	27036-701	LIGHT PANEL - HOOD	PANNEAU LEGER DE LA CUVE	1	1
18	22005-281	GRID - PORCELAIN	GRILLE EN PORCELAINE	5	5
20	22006-991	GRID - WARMING RACK	GRILLE - MAINTIEN AU CHAUD	1	1
22	22226-014	COLLECTOR BOX - FRONT LOWER	RECIPIENT - FRONTAL INFERIEUR	1	1
24	22216-014	COLLECTOR BOX - FRONT UPPER	RECIPIENT - FRONTAL SUPERIEUR	1	1
25	22909-104LP	BURNER	BRÛLEUR	5	•
	22909-104NG	BURNER	BRÛLEUR	•	5
26	22001-768	CONTROL KNOB	BOUTON DE CONTROLE	5	5
26A	22001-668	CONTROL KNOB	BOUTON DE CONTROLE	2	2
27	22002-268	CONTROL BEZEL	MONTURE DE CONTROLE	5	5
27A	22001-168	CONTROL BEZEL	MONTURE DE CONTROLE	2	2
28	22006-494	CONTROL COVER	PANNEAU DE CONTROLE	1	1
34	S13470-091	HOSE-SIDE BURNER LP	TUYAU DU BRULEUR LATERAL PL	1	•
	S13470-132	HOSE-SIDE BURNER NG	TUYAU DU BRULEUR LATERAL GN	•	1
34A	Y-11230	COTTER PIN	ATTACHE DE CHEVILLE	1	1
35	29006-074	CONTROL ASSEMBLY	SOUPAPE	1	•
	29006-077	CONTROL ASSEMBLY	SOUPAPE	•	1
36	10342-T18	ELECTRODE - SIDE BURNER	ELECTRODE - BRULEUR DE COTE	1	1
37	20809-957	TUBE-REAR BURNER ASSY	TUBE DE BRÛLEUR ARRIÈRE	1	1
38	Y-11990	HEX NUT	ÉCROU	1	1
40	10114-20	HOSE & REGULATOR	TUYAU ET REGULATEUR PL	1	•
	10111-K45	HOSE NATURAL GAS	TUYAU (GAZ NATUREL)	•	1
43	10342-E13	ELECTRODE	ELECTRODE	3	3
44	10342-251	ELECTRONIC IGNITOR	ALLUMAGE ÉLECTRONIQUE	1	1
47	21036-991	GREASE RAIL	GUIDE DU BAC A GRAISSE	2	2
48	22009-901	GREASE PAN	CUVETTE A GRAISSE	1	1
49	27056-901	GREASE TRAY	PLATEAU A GRAISSE	1	1
51	22209-904	FLAV-R-WAVE ®	FLAV-R-WAVE ®	5	5
52	26109-331	SIDE PANEL - CRESENT LEFT	PANNEAU LATERAL - GAUCHE	1	1
53	26109-311	SIDE PANEL - CRESENT RIGHT	PANNEAU LATERAL - DROITE	1	1
54	26306-301	LID - OUTER PANEL	COUVERCLE - PANNEAU EXTERIEUR	1	1
55	26206-90	LID - INNER PANEL	COUVERCLE - PANNEAU INTERIEUR	1	1
56	26006-34	HANDLE	POIGNÉE	1	1
57	26006-305	STRAP - HANDLE	COURROIE - POIGNÉE	1	1
59	44089-60	NAMEPLATE	PLAQUE D'IDENTIFICATION	1	1
60	10571-6	HEAT INDICATOR	INDICATEUR DE CHALEUR	1	1
65	20005-000	MATCH LIGHT - STICK	ALLUMETTES	1	1
68	21276-311A	DOOR	PORTE	1	1
69	21276-331A	DOOR	PORTE	1	1
70	21475-138	HANDLE	POIGNÉE	2	2
78	21336-115	BRACKET - DOOR CATCH	CROCHET DE PORTE	1	1
80	21109-905R	SIDE PANEL	PANNEAU LATERALE	2	2
82	25208-205R	CABINET SHELF	L'ETAGERE DU CABINET	1	1
83	21036-905R	CABINET SHELF SUPPORT	SUPPORT POUR L'ETAGERE	1	1
84	21526-375	BASE - TANK	TABLETTE INFERIEUR	1	•
85	21526-395	BRACKET - TANK BASE	SUPPORT DU RESERVOIR	1	•
86	Y-99101	SLIDE - TANK BASE	TIROIR TABLETTE DE BARBONE	1	•
88	21306-925R	PANEL - REAR	PANNEAU - ARRIÈRE	1	1
90	51096-955R	BASE	TABLETTE INFERIEUR	1	1
100	21039-911	BRACKET - CASTOR SUPPORT	SUPPORT DE ROULLETTE	2	2
102	10892-23	CASTOR	ROULETTES	4	4
103	21009-955	BRACKET - CYLINDER LP	SUPPORT DU RESERVOIR PL	1	•
110	23030-635	SHELF BRACKET	CROCHETS PLATEAU	2	2
111	23030-615	SHELF BRACKET	CROCHETS PLATEAU	2	2
112	20409-934	STRAP - HANDLE	COURROIE - POIGNÉE	4	4
114	23101-614	SHELF	PLANCHETTE LATERALE	1	1
115	23100-654	SHELF	PLANCHETTE LATERALE	1	1

PARTS LIST / LISTE DES PIECES

KEY #	ITEM #	DESCRIPTION	DESCRIPTION	6781-84	6781-87
116	23401-631	SHELF FRONT	PLANCHETTE FRONTALE	1	1
116A	23401-611	SHELF FRONT	PLANCHETTE FRONTALE	1	1
117	23009-608	HANDLE	POIGNEE	2	2
124	23000-271	SIDE BURNER BODY	SUPPORT DE BRULEUR DE COTE	1	1
125	23000-254	SIDE BURNER COVER	COUVERCLE LATÉRAL	1	1
126	23909-20	SIDE BURNER	BRULEUR DE COTE	1	1
128	23009-98	GRID	GRILLE	1	1
130	27906-35	BURNER ROTISSERIE	BRÛLEUR DE TOURNEBROCHE	1	1
131	10693-109	REAR BURNER-ORIFICE	ORIFICE DU BRÛLEUR ARRIÈRE	1	•
	10693-160	REAR BURNER-ORIFICE	ORIFICE DU BRÛLEUR ARRIÈRE	•	1
133	S15271	HANDLE	POIGNEE	1	1
134	S15270	BALANCER	CONTREPOIS	1	1
135	S15299	WASHER	RONDELLE	1	1
136	S15263	BUSHING	COL	1	1
137	S15259	SPIT ROD	BROCHETTE	1	1
138	S15287	4 PRONG FORKS	FOURCHETTE A 4 FOURCHON	1	1
139	57039-901	ROTISSERIE BRACKET	SUPPORT	1	1
140	S21125	SCREW #8 X 1/2	VIS #8 X 1/2	28	28
143	Y-12855	BOLT 1/4-20 X 3/8	BOULON 1/4-20 X 3/8	60	60
144	Y-12220	BUSHING	DOUILLE	1	1
145	S21235	HINGE PIN	GOUPILLE DE CHARNIÈRE	2	2
146	S21233	HITCH PIN CLIP	ATTACHE DE CHEVILLE	7	7
147	Y-11231	LID BUMPER	BUTOIR DU COUVERCLE	4	4
148	10240-20	DOOR PIN	GOUPILLE DE LA PORTE	2	2
149	10240-19	DOOR PIN	GOUPILLE DE LA PORTE	2	2
150	Y-12124	DOOR PIN CAP	DISTANZHALTERUNG	2	2
152	Y-12222	MAGNET	AIMANT	2	2
153	Y-12223	SNAP IN MAGNET	AIMANT	2	2
154	Y-11560	SCREW 1/4-20 X 1-1/2	VIS 1/4-20 X 1-1/3	8	8
155	S21124	SCREW #8 X 1/2	VIS #8 X 1/2	27	27
156	Y-11793	NUT 1/4-20	ECROU 1/4-20	14	14
157	Y-12835	SCREW #6-32 X 1/4	VIS #6-32 X 1/5	3	3
158	Y-12646	SCREW SHOULDER #8 X 1/2	VIS SHOULDER #8 X 1/3	2	2
160	Y-29304	BOLT #10-24 X 3/8	BOULON #10-24 X 3/8	39	39
161	Y-29310	SCREW #10-24 X 3/4	VIS #10-24 X 3/4	8	8
162	Y-29307	NUT #10-24	ECROU #10-24	4	4
163	S35094	SCREW #10-24 X 5/8	VIS #10-24 X 5/8	7	7
164	S21084	SCREW #14 X 5/8	VIS #14 X 5/8	4	4
165	Y-12127	DOOR PIN CAP	DISTANZHALTERUNG	2	2
167	Y-11987	BOLT 1/4-20 X 1	BOULON 1/4-20 X 1	6	6
168	Y-11208	WASHER	RONDELLE	2	2
169	S21061	WING NUT	ECROU PAPILLON	2	2
171	S15245	MOTOR	MOTEUR	1	1
173	S21362	SPRING	RESSORT	1	1
174	S21255	WASHER	RONDELLE	2	•
175	Y-11546	CARRIAGE BOLT - 1/4:20 X 5/8	BOULON - 1/4:20 X 5/8	2	•
176	Y-11795	NUT 1/4-20	ECROU 1/4-20	2	•
180	S35095	SCREW #10-24 X 5/8	VIS #10-24 X 5/8	2	2
181	25070-90	LIGHT SWITCH	COMMUTATEUR LEGER	1	1
182	25020-71	OVEN LIGHT	LUMIERE DE FOUR	2	2
183	25090-90	POWER BAR	BARRE ELECTRIQUE	1	1
184	25080-90	TRANSFORMER	TRANSFORMATEUR	1	1
185	25030-71	WIRE - OVEN LIGHT	LE FIL - LUMIERE DE FOUR	1	1
186	Y-12310	SCREW 1/4-20 X 3/4	VIS 1/4-20 X 3/4	10	10

