

This Owner's Manual is provided and hosted by [Appliance Factory Parts](#).



HUNTINGTON 6771-87 Owner's Manual

[Shop genuine replacement parts for HUNTINGTON
6771-87](#)



[Find Your HUNTINGTON Grill Parts - Select From 154 Models](#)

----- Manual continues below part list -----

Available Replacement Parts for HUNTINGTON 6771-87

18013	LARGE PROBE HEAT INDICATOR
S21233	HITCH PIN CLIP +
S21255	WASHER 26 ID X 3/4 OD X 1/16 +
Y-11793	NUT HEX 1/4 20 JS500 +
Y-12646	SCREW PHCP SHL.8X1/2 TY-AB +
Y-12835	SCREW-PHCP 6-32X1/4 TY-F JS500
Y-29307	NUT HEX #10-24 JS500
Y-11230	HAIRPIN COTTER SIDE BURNER +
S21362	REAR BURNER SPRING
Y-11546	SCREW PHCP 1/4-20X5/8 INCH A04#A
Y-12855	SCREW PHCP 1/4-20X3/8UNC-2A + A04 #A
Y-11795	NUT LOCKING
S21124	SCREW PHCP #8 X 12 +
Y-29304	SCREW PHCP #10 24x3/8
Y-12220	S/B BUSHING SB 1.375 16 HEY
S21235	HINGE PIN W/HOLE
Y-11560	BOLT PHCP 1/4 20x1-1/2 TYC +
S21125	SCREW 8 X 3/8 PAN HEAD
10342-244	IGNITOR ELECTRONIC +
S15236	ROTISSERIE MOTOR AC 120V
S15263	ROTISSERIE BUSHING
S15299	WASHER COUNTERWEIGHT ROTIS
S15270	ROTISSERIE COUNTERWEIGHT ASSY
S15271	ROTISSERIE HANDLE +
S35094	SCREW #10-24 X 5/8
S21061	WING NUT STAMPED 10-24
Y-11987	BOLT CARRIAGE 1/4-20x1.25 UNC+
18433	OEM FLAV R WAVE - REGAL/IMPERIAL
Y-11231	LID BUMPER ROUND BLK
Y-12223	MAGNET SNAP IN - DOOR

Y-12222	MAGNET - DOOR
23000-253	SIDE BURNER LID IR SS
23000-271	SIDE BURNER BODY BASE
22009-901	GREASE PAN FORMED +
S21084	SCREW HEX WASHER HEAD #14x3/4
10342-E13	ELECTRODE W/WIRE
10342-T18	WIRE ELECTRODE S/B 600 +
27005-91	FIREBOX-HEAT SHIELD 500 4V .5 GALVALUM C
27003-91	HEAT SHIELD 250 .5 GALVALUM B
22005-991	WARMING RACK PORC COATED 500
29018-074	CONTROL ASSEMBLY LP 6V +
20809-957	REAR BURNER TUBE ASSMBLY W/COMP. FITTING
10693-109	ORIFICE SPUD RB 1.09MM 5/16 32
S15260	SPIT ROD ROTISSERIE 750 45 INCH
29018-077	CONTROL ASSY 6V S/B R/B NG
10240-20	DOOR PIN TOP
10240-19	DOOR PIN BOTTOM
Y-12124	DOOR PIN CAP BOTTOM
27055-901	GREASE TRAY PORC FORMED 440 +
21175-111A	DOOR ASSEMBLY RIGHT BLACK
21475-138	DOOR HANDLE RESIN
23009-608	SHELF STRAP RESIN W/SS STRIP +
23100-654	SIDE SHELF INSERT LHS 430SS +
11229	EXACT FIT CAST GRID - REGAL/IMPERIAL
10693-160	ORIFICE SPUD 1.60MM 5/16-32
21039-911	CASTER BRACKET BLACK
Y-12127	DOOR CLIP UPPER
Y-29310	SCREW #10-24 3/4 TRUSS QU
20005-000	HARDWARE BAG STICK & CHAIN SS
10240-17	HINGE PIN 750 DUAL
25070-90	SWITCH - OVEN LIGHT
10892-23	CASTER RUBBER 3 INCH W/PLATE
44089-60	NAMEPLATE PATRIOT

Y-99101	DRAWER SLIDE SET LHS & RHS 16 INCH
18633	BURNER - REGAL/IMPERIAL
22003-991	GRID - WARMING RACK 250 PORC
82315-021	COOKBOX 500 HOOD PANEL PORC
25080-90	TRANSFORMER ASSY GPB
21175-131A	DOOR ASSEMBLY LEFT BLACK
27008-494	CONTROL COVER 750 430SS
80012	regulator and hose READ ADD. INFO
21335-115	TOP MAGNET-BRACKET 500 BLK CHR
57039-901	ROTISSERIE BRACKET BLK
82305-021R	FIREBOX 500 REAR PANEL PNTD W/RIVNUTS
Y-12865	SCREW 1/4 X 20X1/2 TYPE-C PHCP
50502	HEAVY DUTY MEAT FORKS
10390-R81A	SIDE BURNER ASSY
12023-103	COLLECTOR BOX ASSY 250 SS
23009-99	SIDE BURNER TRIVET CI
17000	CONTROL KNOB - SMALL BLACK
17010	CONTROL KNOB RESIN LRG BLACK
Y-11544S	SCREW - BURNER #10-24 X 3/8
10111-K45	HOSE 3/8 INCH ASSEMBLY NG 10 FOOT +
Y-11990	NUT HEX BRASS 3/8 27 RB LINE
10342-247	IGNITOR ELECTRONIC +
22001-168	CONTROL KNOB BEZEL SML
22002-268	CONTROL KNOB BEZEL LARGE
21035-991	GREASE RAIL 440/500 SABLE BLK
27905-354	BURNER TUBE REAR 500 W/WINDSHIELD
27249-904	GREASE SHIELD MODULAR, 6.5 x 6
22025-903	COLLECTOR BOX ASSY 500 430SS
23101-613	SIDE SHELF - RIGHT SS430

HUNTINGTON™

REDDI-BILT BARBECUES

ASSEMBLY MANUAL & PARTS LIST

MANUEL DE MONTAGE & LISTE DE PIÈCES



HUNTINGTON™

PATRIOT 690
6771-84
6771-87

RETAIN FOR FUTURE REFERENCE

VEUILLEZ CONSERVER POUR REFERENCE ULTERIEURE

1-800-265-2150

info@omcbbq.com

Onward
MANUFACTURING COMPANY
SINCE 1906
1000 EAST MARKET STREET
HUNTINGTON, INDIANA, 46750, USA

20084-E58 REV A 03/13

1

(24)

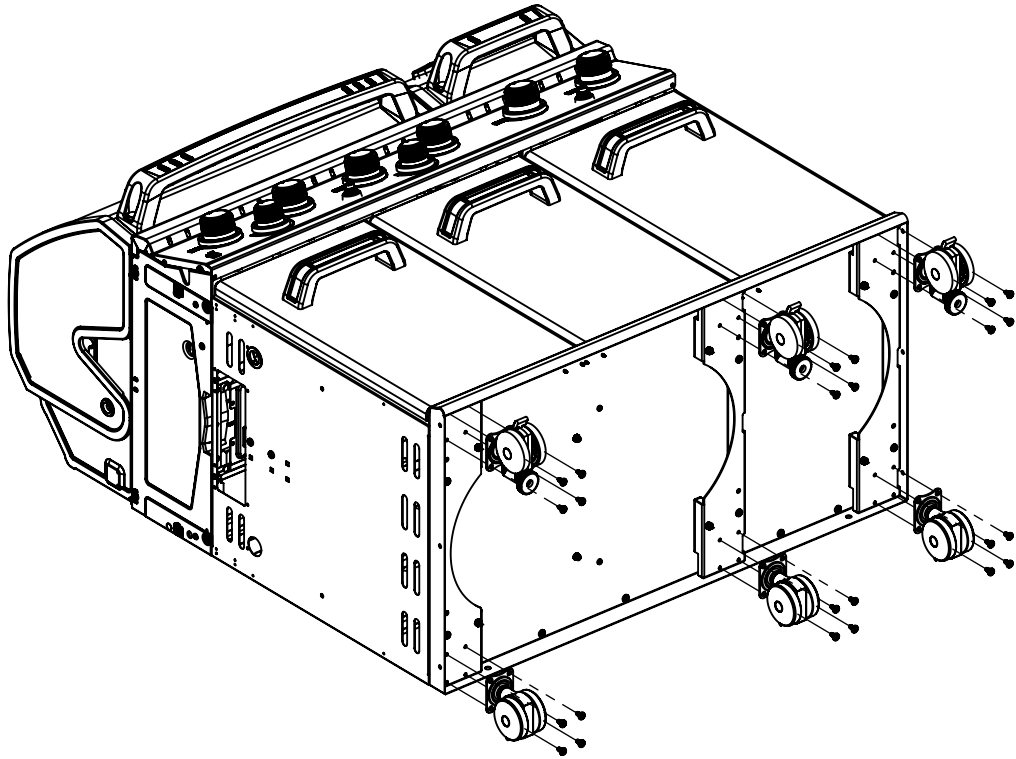
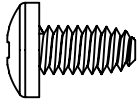

2

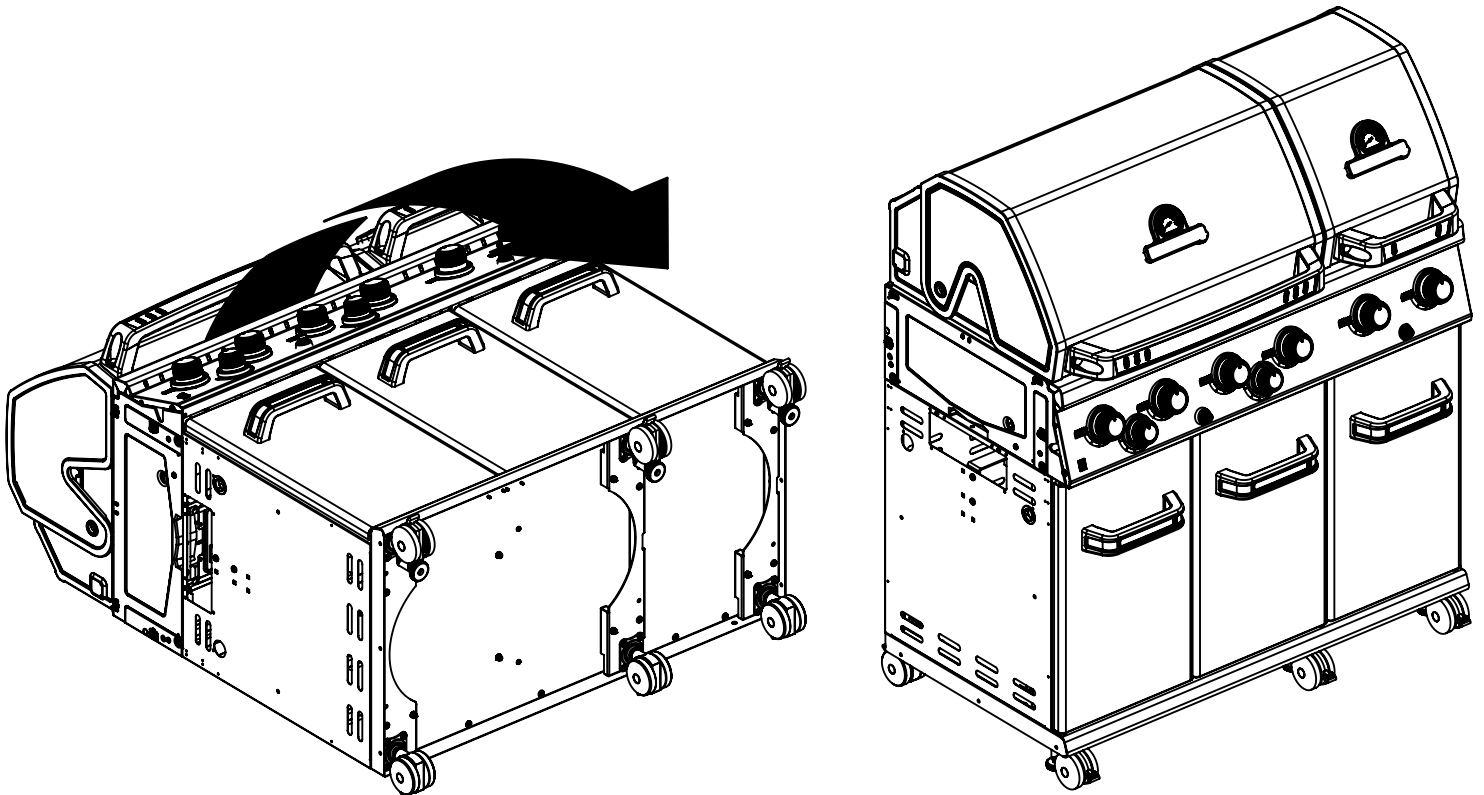

3

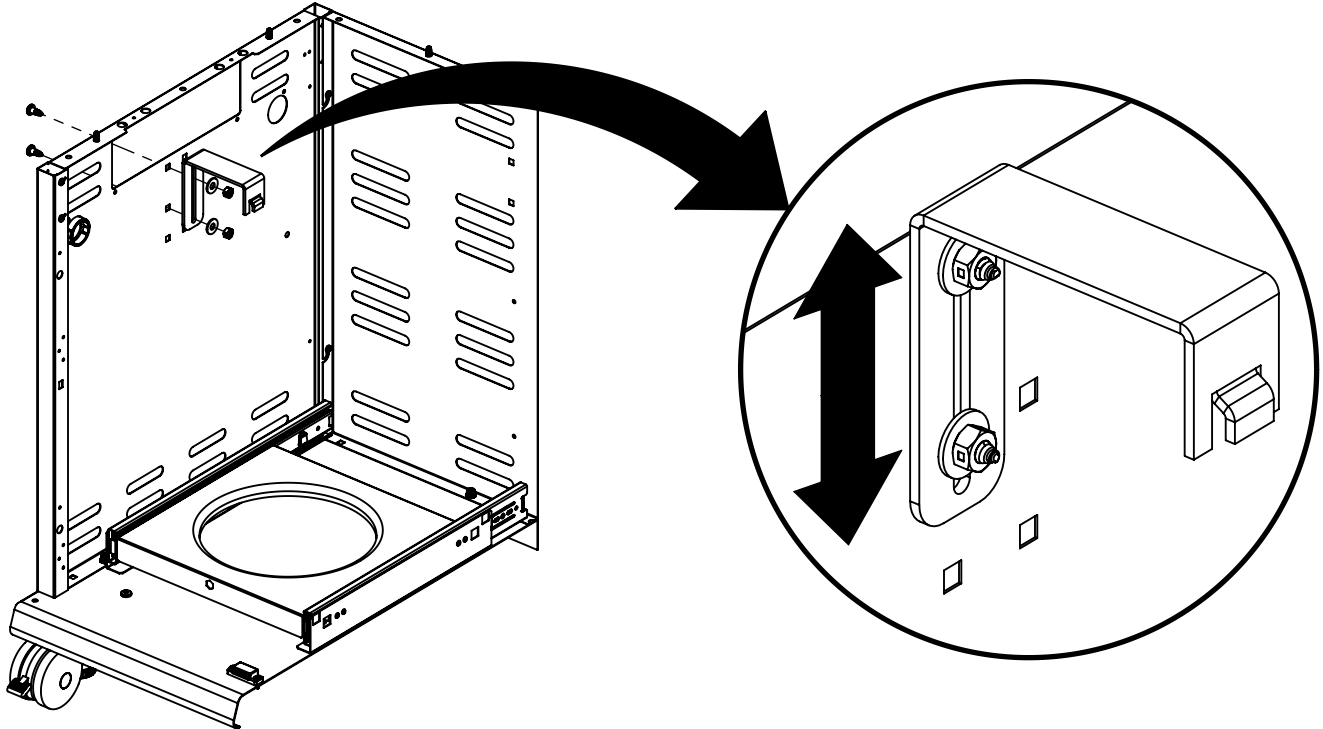
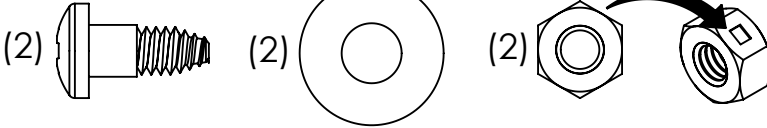

4

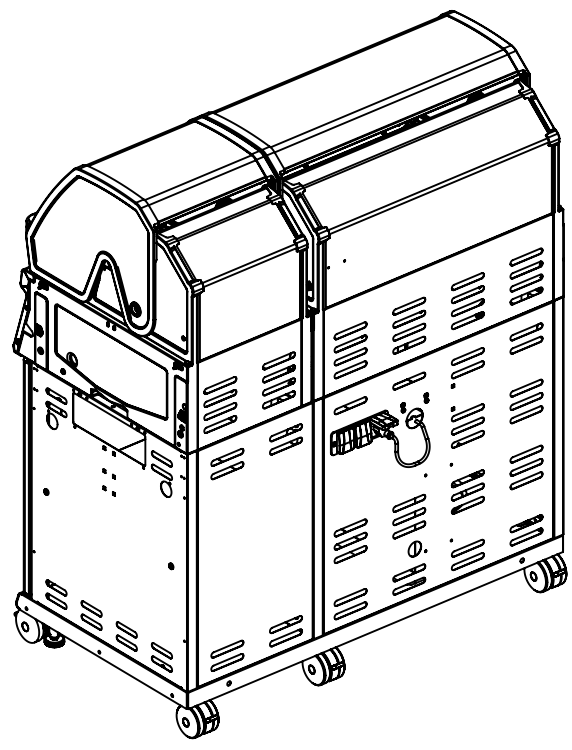

5

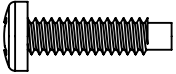
(2) 

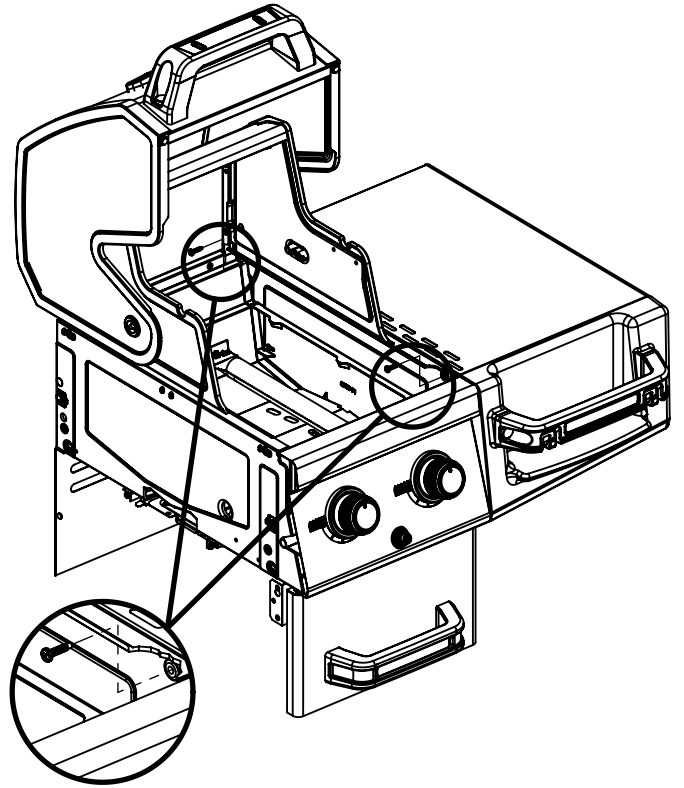
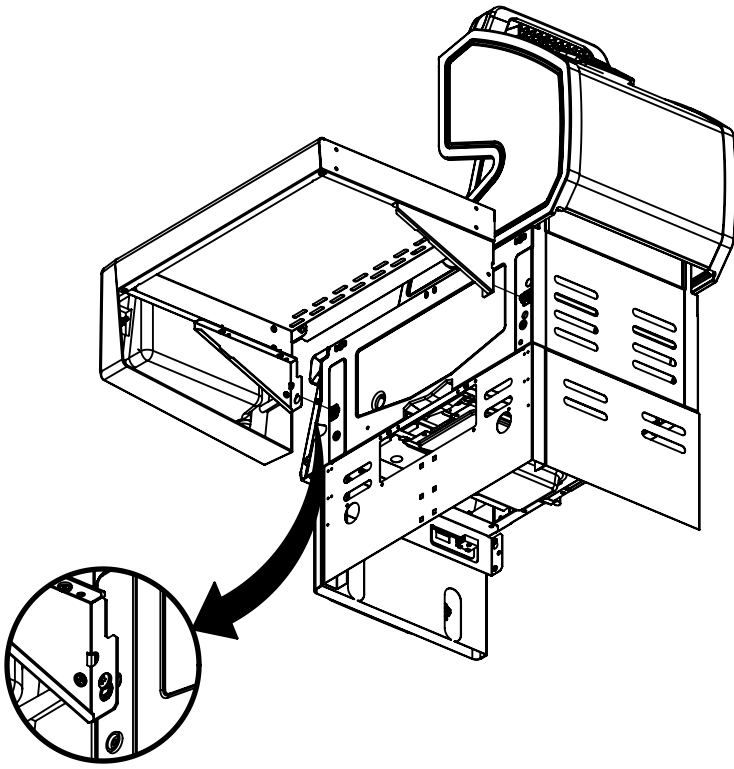

6

(2) 

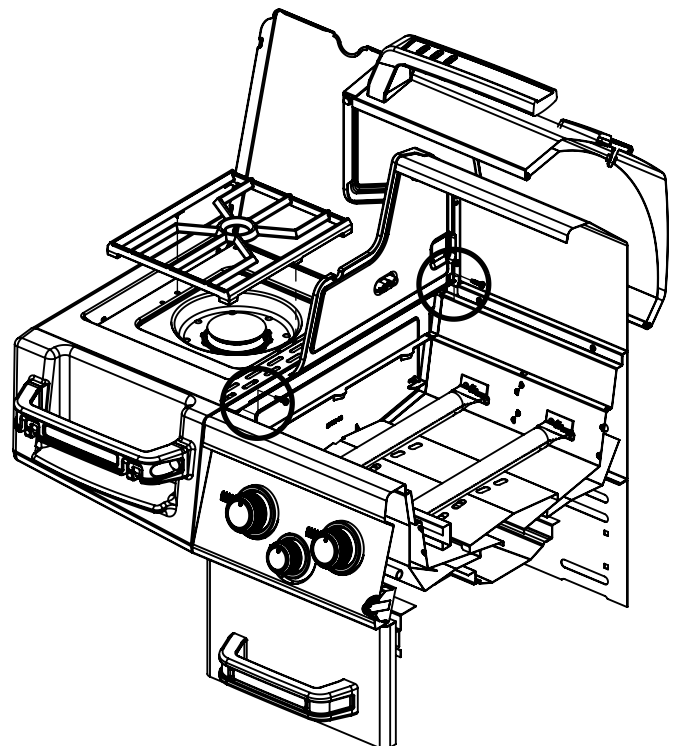
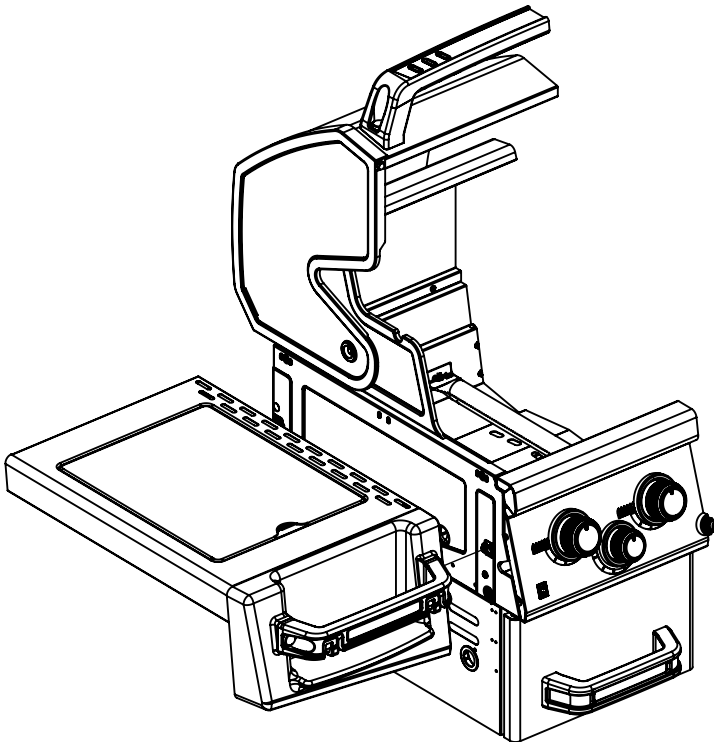

7

(1)

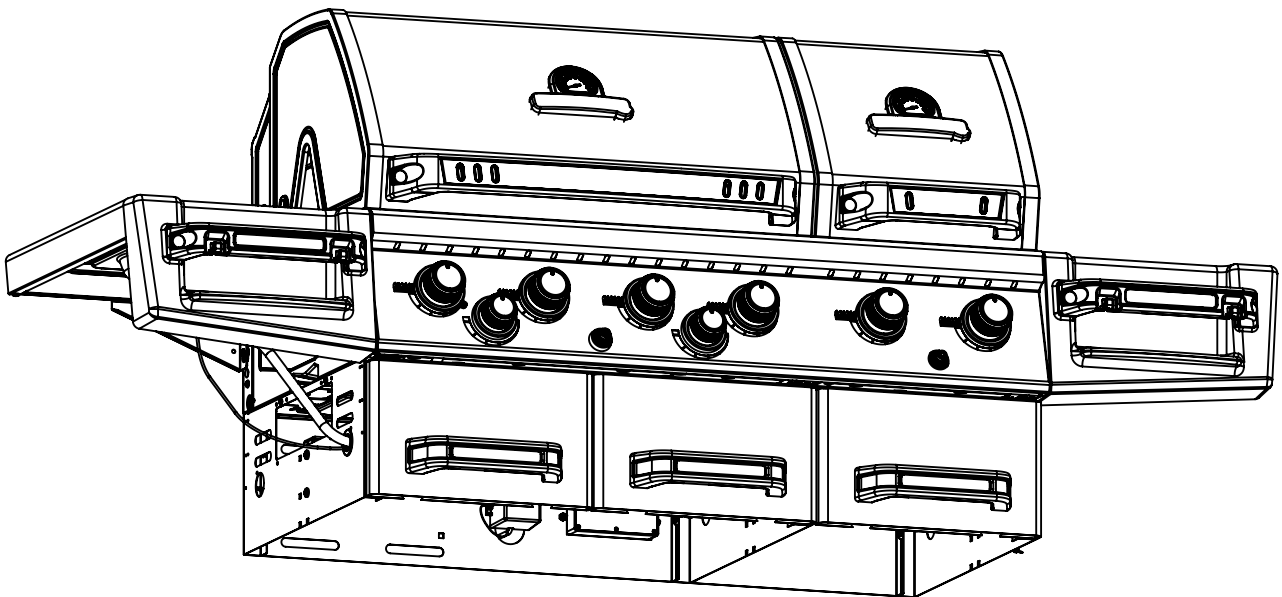
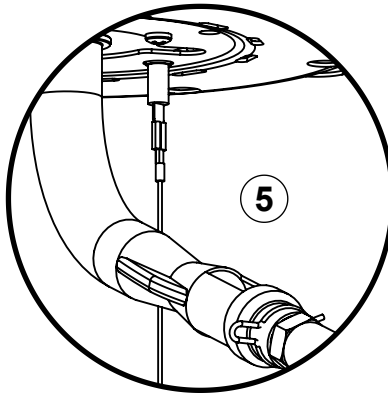
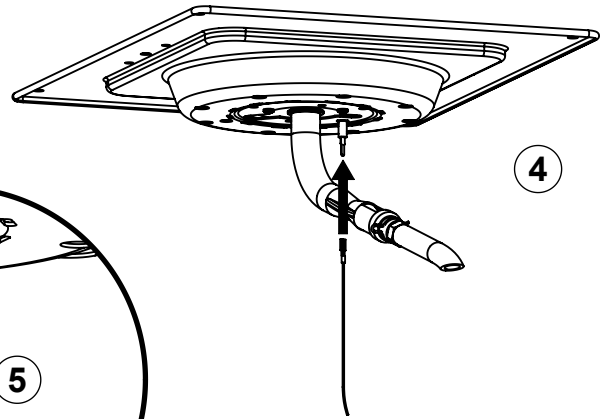
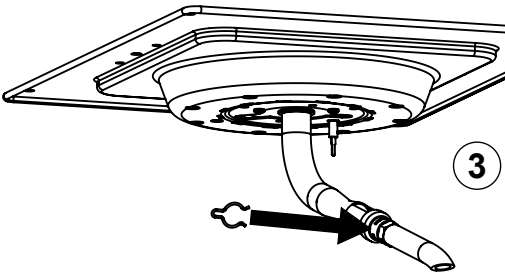
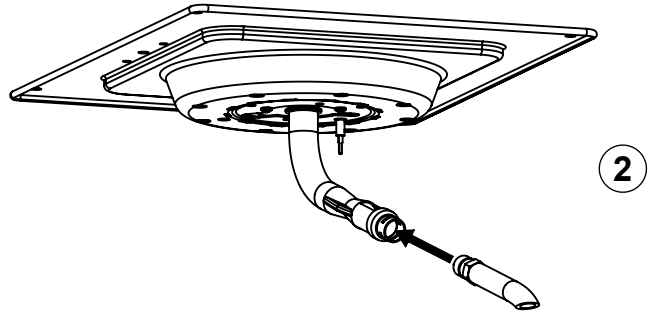
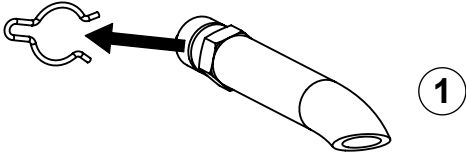
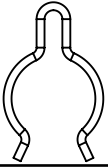

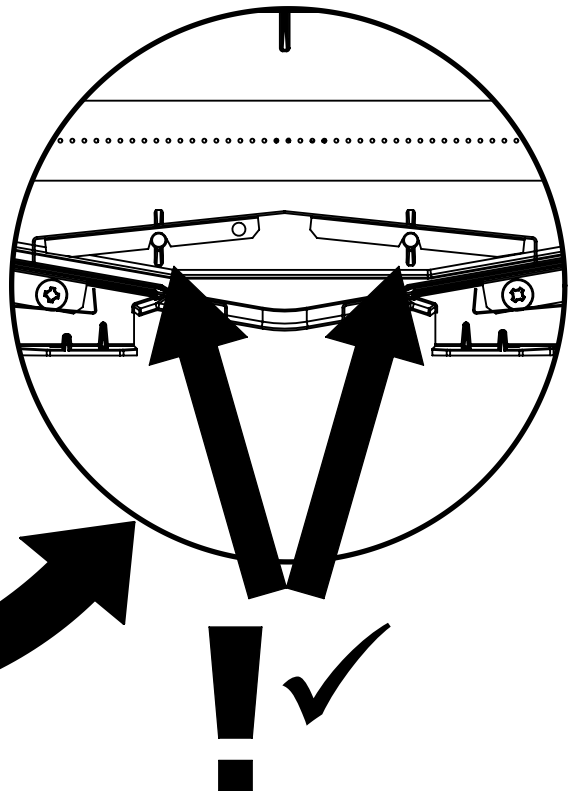
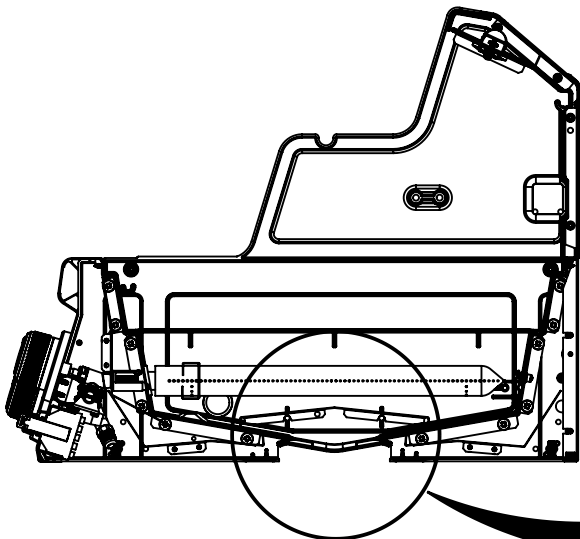
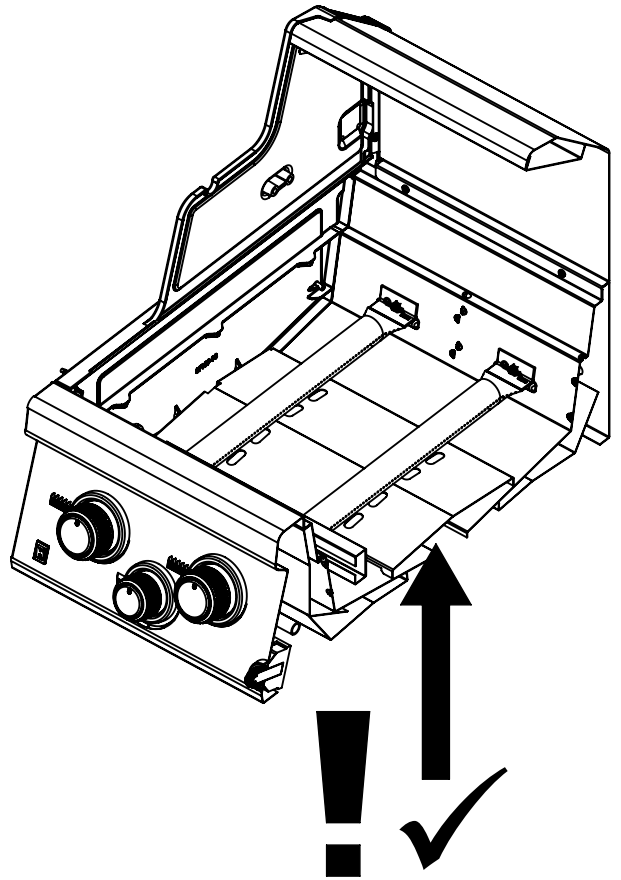
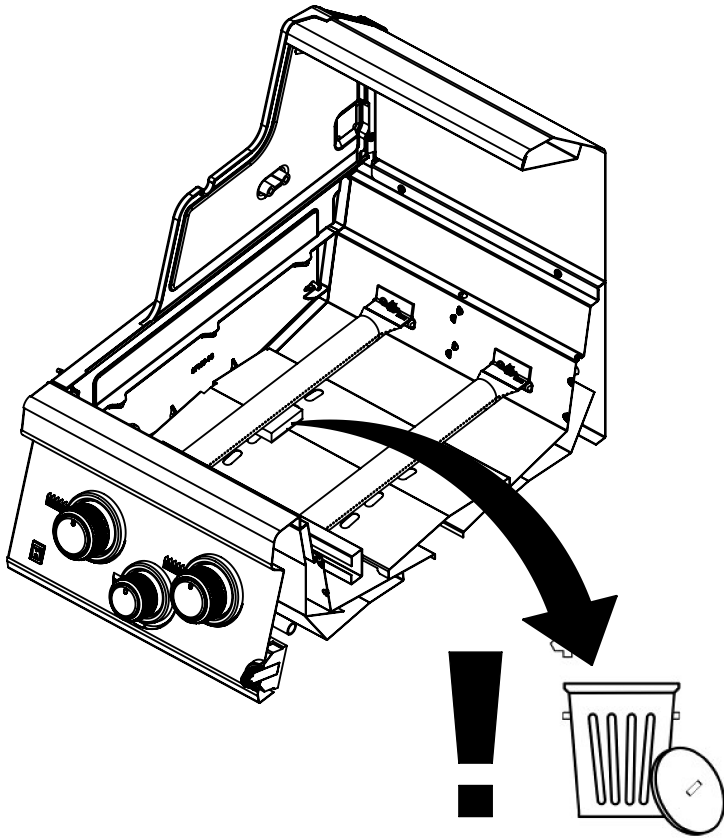

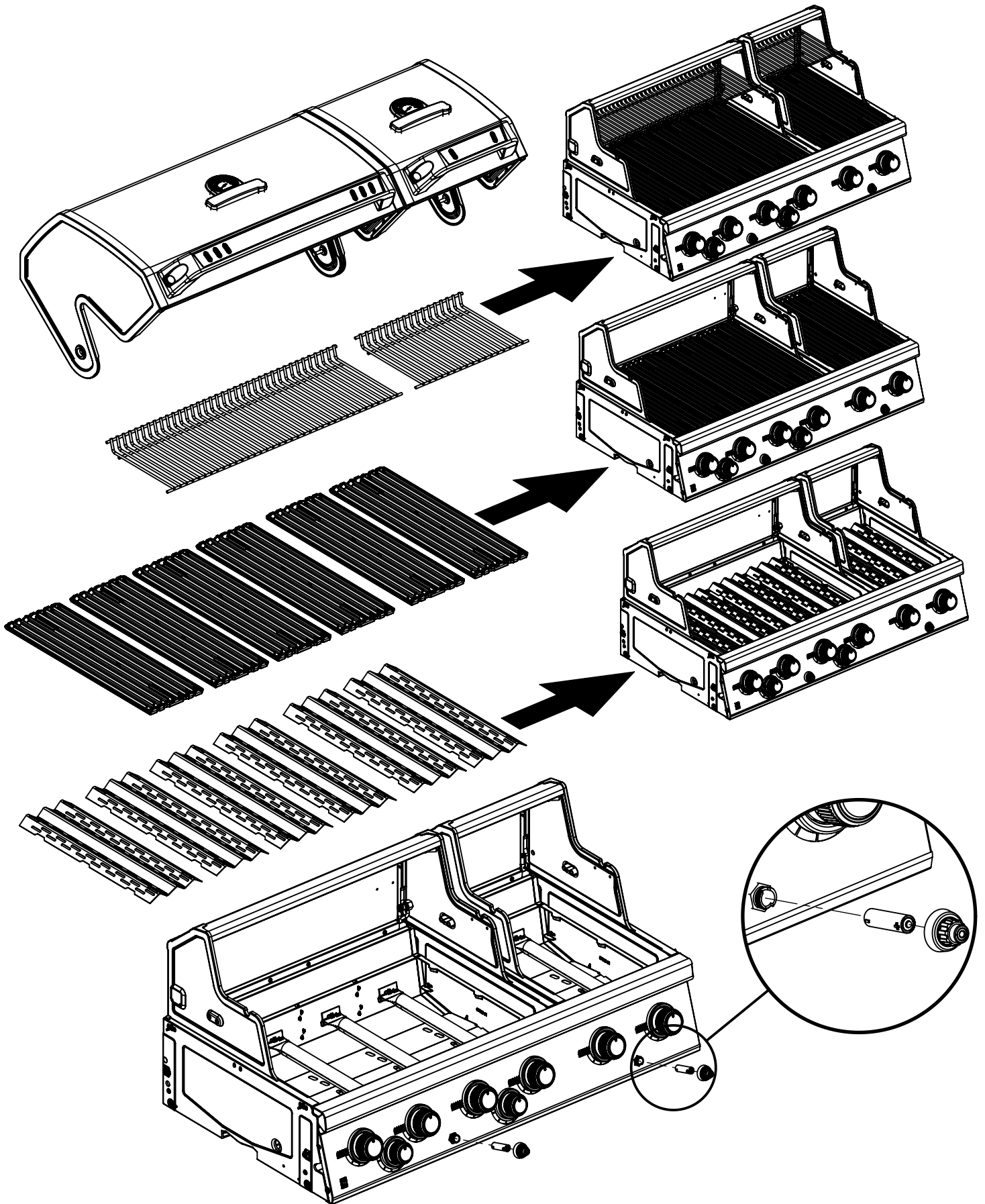

10

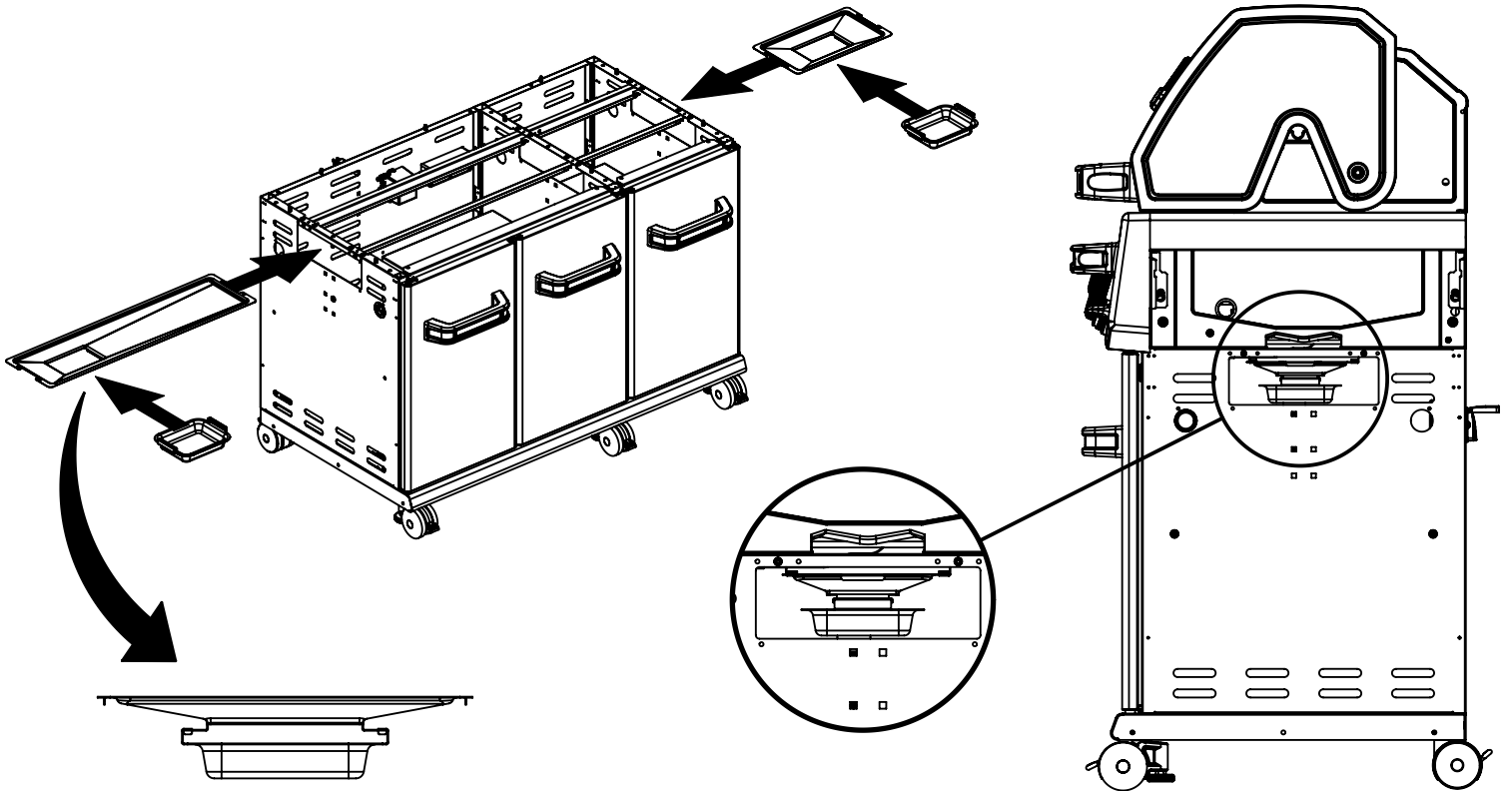

11

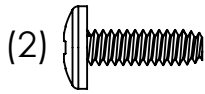

(2)

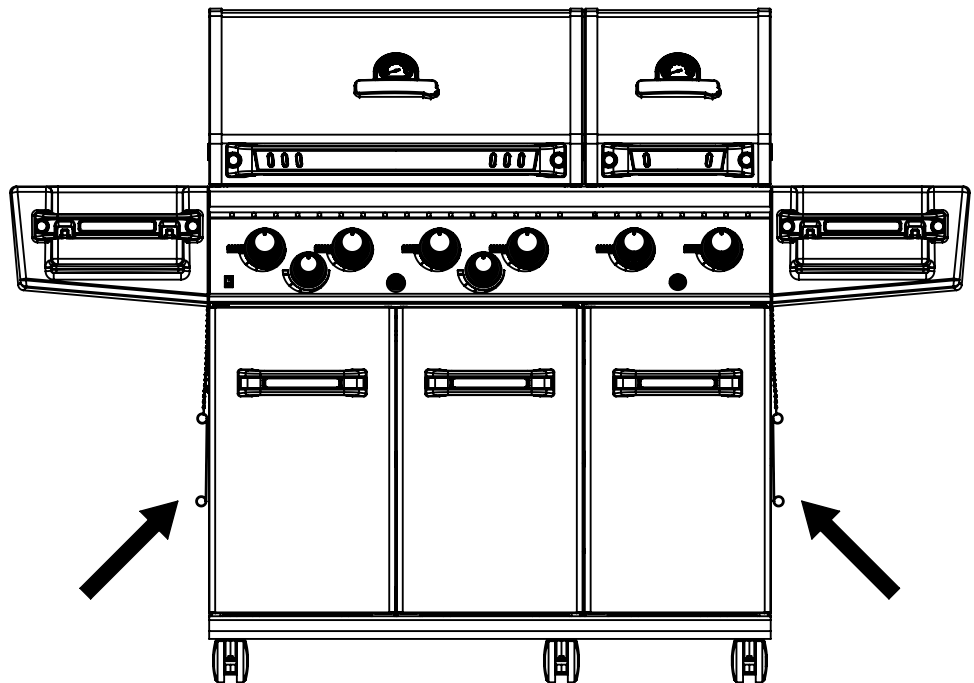
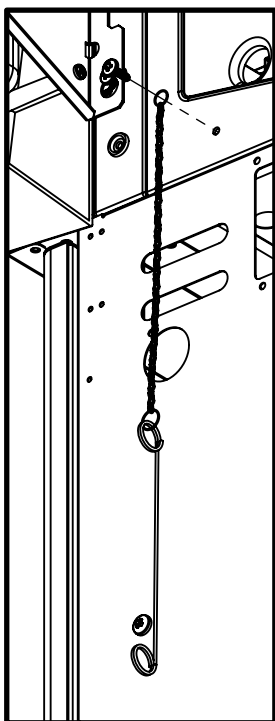
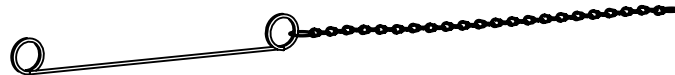

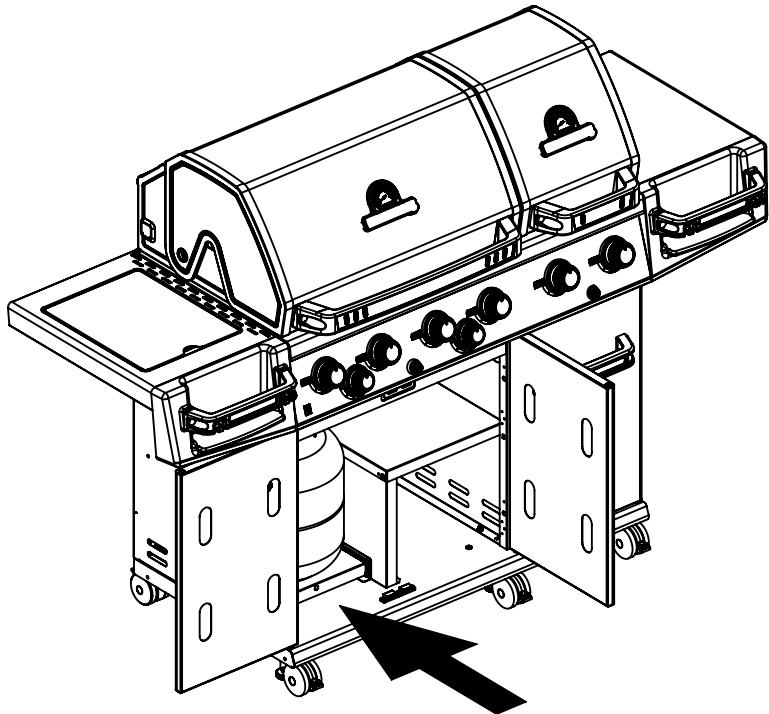
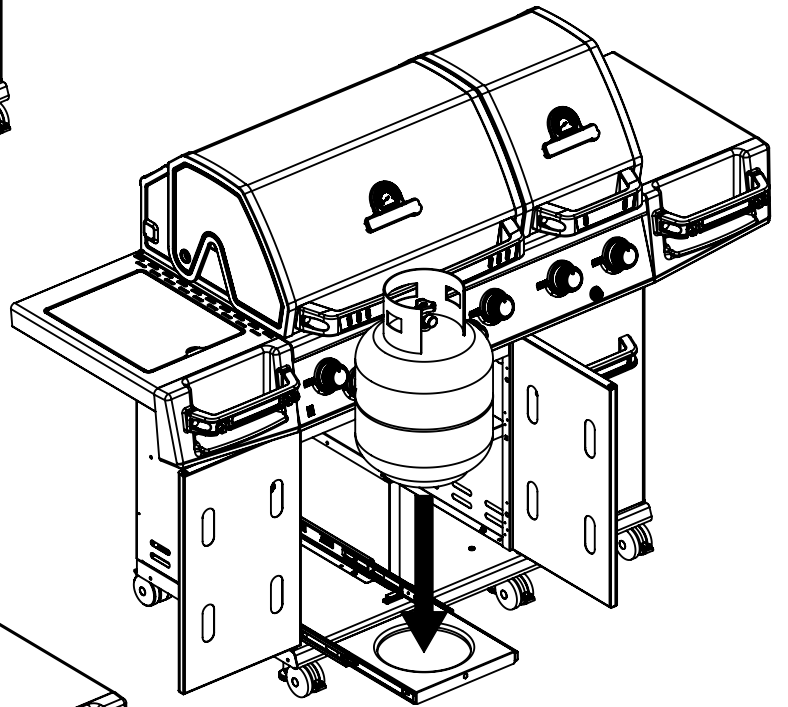
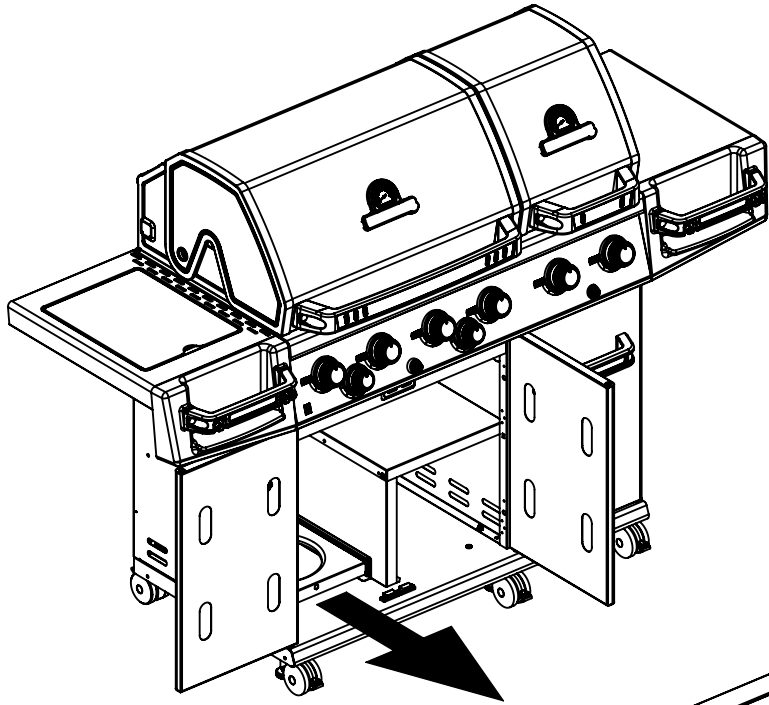

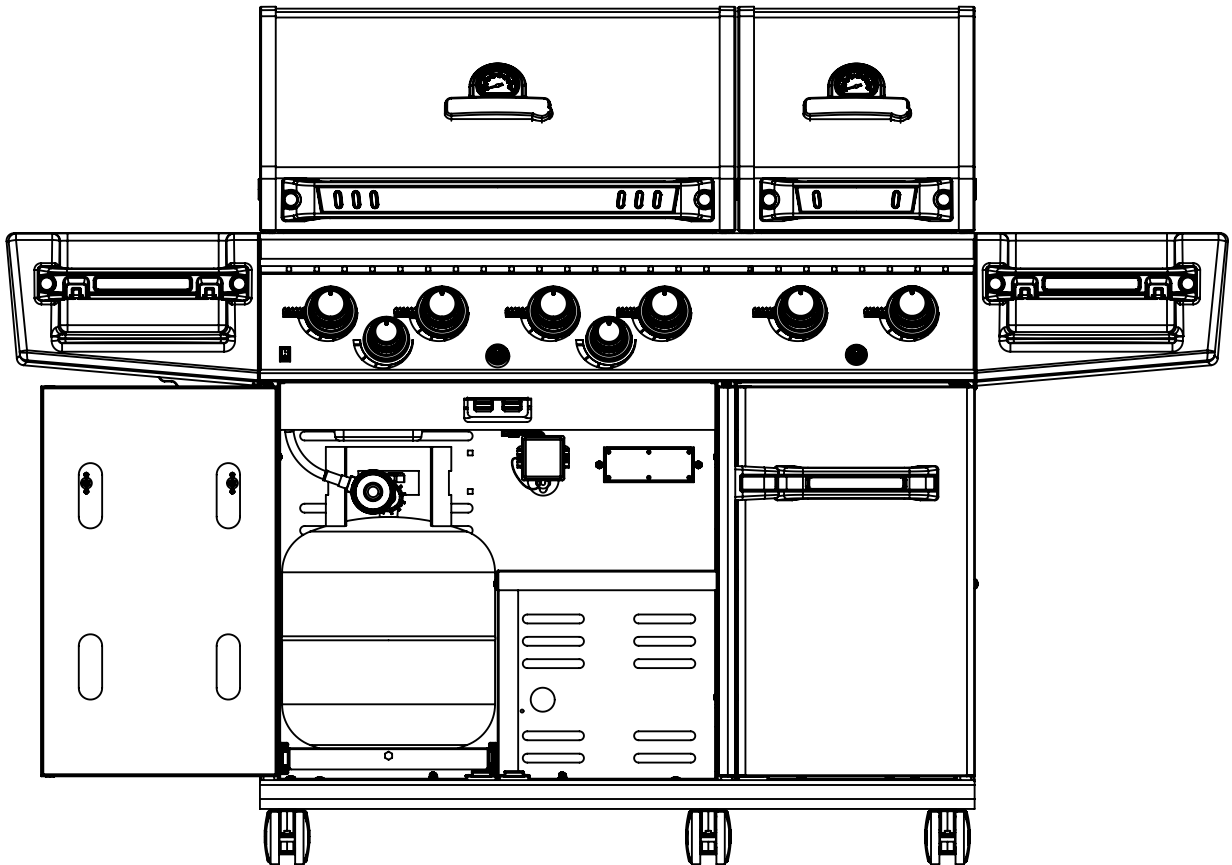
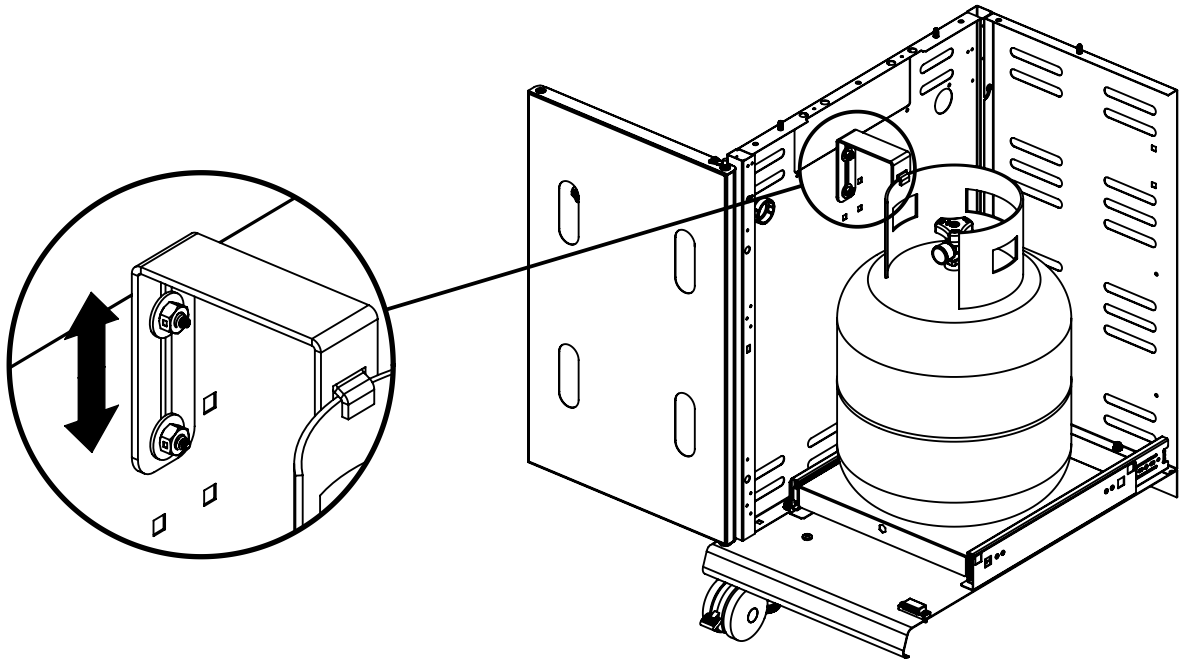

14

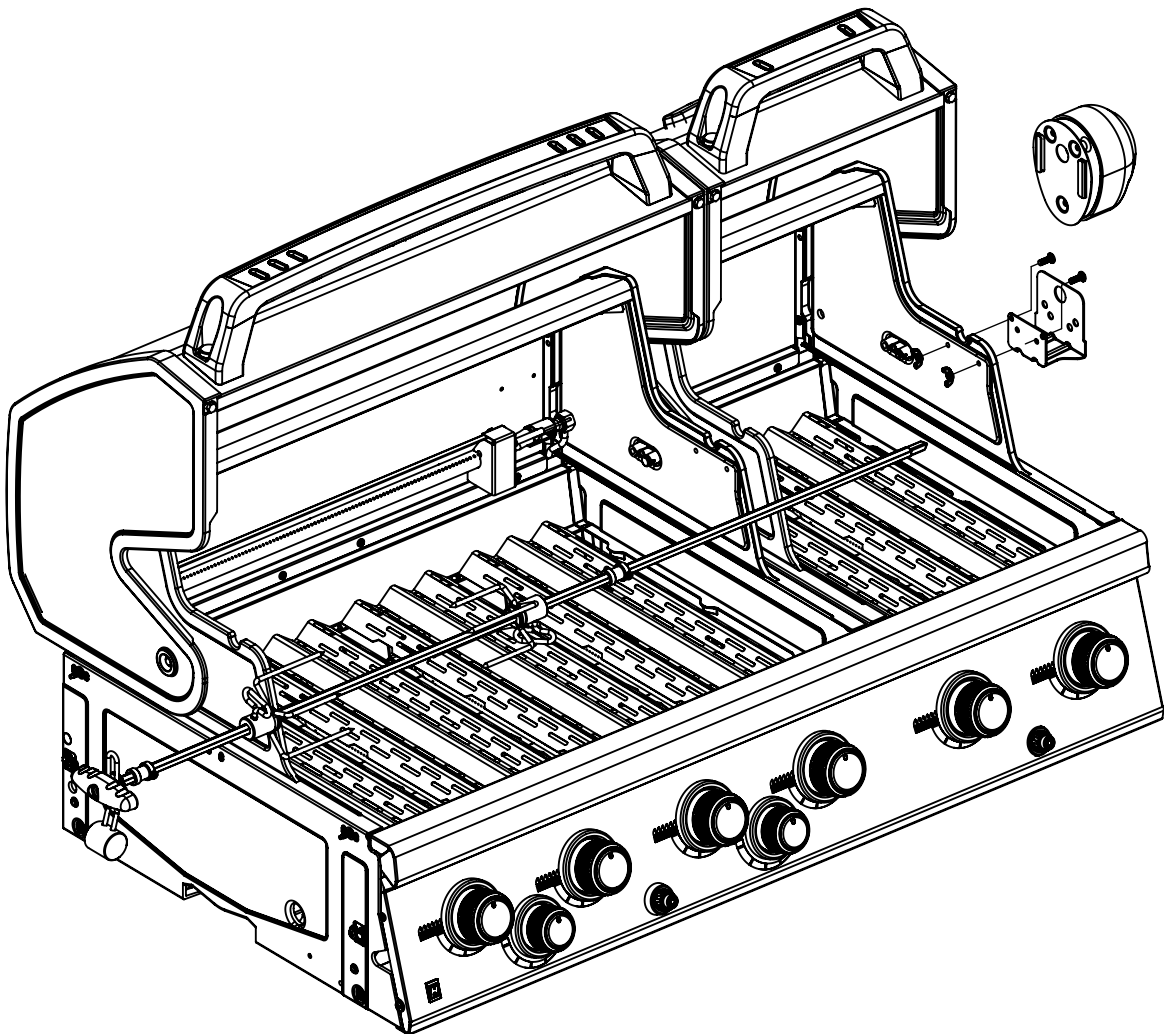
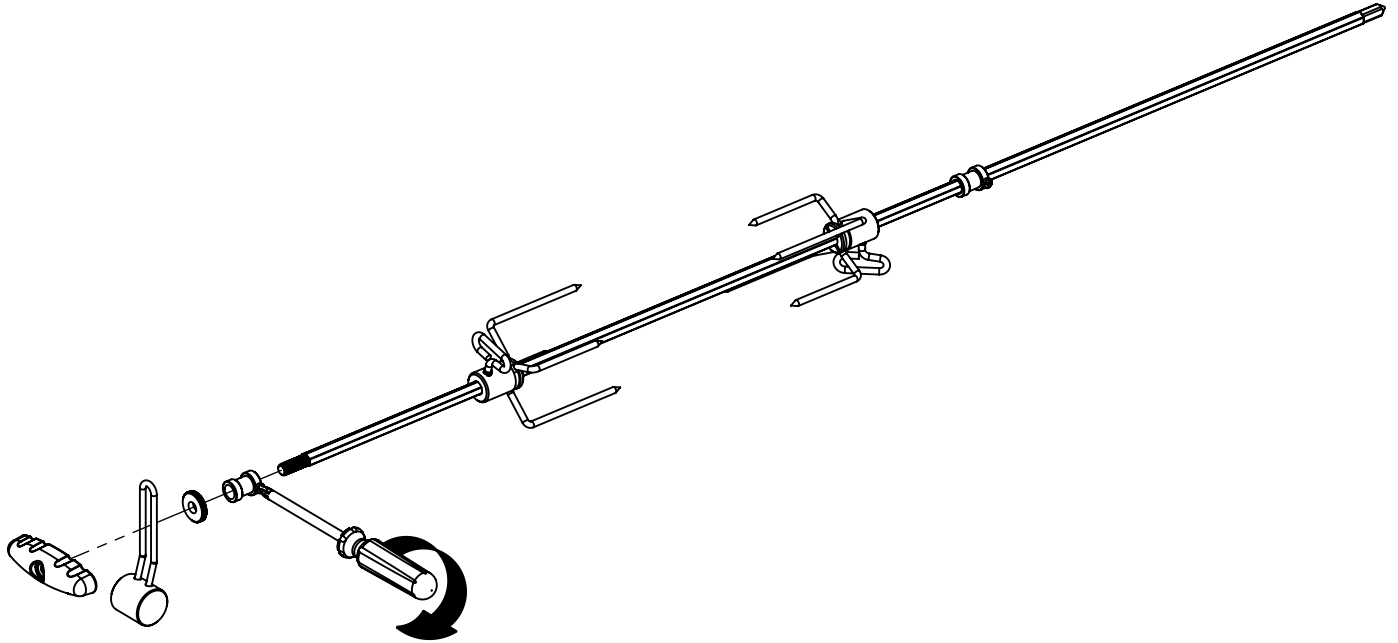

PARTS LIST / LISTE DES PIÈCES

KEY #	ITEM #	DESCRIPTION	DESCRIPTION	6771-84	6771-87
1	87109-931	PANEL - SIDE LEFT	PANNEAU - CÔTE GAUCHE	2	2
2	87109-911	PANEL - SIDE RIGHT	PANNEAU - CÔTE DROITE	2	2
3	27205-011	PANEL - FRONT INNER	PANNEAU FRONTAL ARRIERE	1	1
3A	27203-011	PANEL - FRONT INNER	PANNEAU FRONTAL ARRIERE	1	1
4	27205-921R	PANEL - INNER REAR	PANNEAU INTERIEUR ARRIERE	1	1
4A	27203-921R	PANEL - INNER REAR	PANNEAU INTERIEUR ARRIERE	1	1
5	27245-904	GREASE SHIELD	PROTECTION CONTRE LA GRAISSE	1	1
5A	27243-904	GREASE SHIELD	PROTECTION CONTRE LA GRAISSE	1	1
6	27005-91	HEAT SHIELD	PROTECTION CONTRE LA CHALEUR	3	3
6A	27003-91	HEAT SHIELD	PROTECTION CONTRE LA CHALEUR	3	3
7	Y-11544	SCREW - BURNER	VIS - BRÛLEUR	6	6
10	82305-021R	PANEL - REAR COOKBOX	PANNEAU - RECIPIENT	1	1
10A	82303-021R	PANEL - REAR COOKBOX	PANNEAU - RECIPIENT	1	1
12	82315-021	PANEL - HOOD	PANNEAU DE LA CUVE	1	1
12A	82313-021	PANEL - HOOD	PANNEAU DE LA CUVE	1	1
13	27035-701	LIGHT PANEL - HOOD	PANNEAU LEGER DE LA CUVE	1	1
13A	27033-701	LIGHT PANEL - HOOD	PANNEAU LEGER DE LA CUVE	1	1
18	22005-281	GRID - PORCELAIN	GRILLE EN PORCELAINE	6	6
20	22005-991	GRID - WARMING RACK	GRILLE - MAINTIEN AU CHAUD	1	1
20A	22003-991	GRID - WARMING RACK	GRILLE - MAINTIEN AU CHAUD	1	1
22	22225-014	COLLECTOR BOX - FRONT LOWER	RECIPIENT - FRONTAL INFERIEUR	1	1
22A	27223-014	COLLECTOR BOX - FRONT LOWER	RECIPIENT - FRONTAL INFERIEUR	1	1
24	22215-014	COLLECTOR BOX - FRONT UPPER	RECIPIENT - FRONTAL SUPERIEUR	1	1
24A	27213-014	COLLECTOR BOX - FRONT UPPER	RECIPIENT - FRONTAL SUPERIEUR	1	1
25	22909-104LP	BURNER	BRÛLEUR	6	•
	22909-104NG	BURNER	BRÛLEUR	•	6
26	22001-768	CONTROL KNOB	BOUTON DE CONTROLE	6	6
26A	22001-668	CONTROL KNOB	BOUTON DE CONTROLE	2	2
27	22002-268	CONTROL BEZEL	MONTURE DE CONTROLE	6	6
27A	22001-168	CONTROL BEZEL	MONTURE DE CONTROLE	2	2
28	27008-494	CONTROL COVER	PANNEAU DE CONTROLE	1	1
34	S13470-091	HOSE-SIDE BURNER	TUYAU DU BRÛLEUR LATÉRAL	1	•
	S13470-132	HOSE-SIDE BURNER	TUYAU DU BRÛLEUR LATÉRAL	•	1
34A	Y-11230	COTTER PIN	ATTACHE DE CHEVILLE	1	1
35	29018-074	CONTROL ASSEMBLY	SOUPAPE	1	•
	29018-077	CONTROL ASSEMBLY	SOUPAPE	•	1
36	10342-T18	ELECTRODE - SIDE BURNER	ÉLECTRODE - BRÛLEUR DE CÔTÉ	1	1
37	20809-957	TUBE-REAR BURNER ASSY	TUBE DE BRÛLEUR ARRIÈRE	1	1
38	Y-11990	HEX NUT	ÉCROU	1	1
40	10114-20	HOSE & REGULATOR	TUYAU ET REGULATEUR PL	1	•
	10111-K45	HOSE NATURAL GAS	TUYAU (GAZ NATUREL)	•	1
43	10342-E13	ELECTRODE	ELECTRODE	3	3
44	10342-247	ELECTRONIC IGNITOR	ALLUMAGE ÉLECTRONIQUE	1	1
44A	10342-244	ELECTRONIC IGNITOR	ALLUMAGE ÉLECTRONIQUE	1	1
47	21035-991	GREASE RAIL	GUIDE DU BAC A GRAISSE	2	2
47A	21033-991	GREASE RAIL	GUIDE DU BAC A GRAISSE	2	2
48	22009-901	GREASE PAN	CUVETTE A GRAISSE	2	2
49	27055-901	GREASE TRAY	PLATEAU A GRAISSE	1	1
49A	27053-901	GREASE TRAY	PLATEAU A GRAISSE	1	1
51	22209-901	FLAV-R-WAVE®	FLAV-R-WAVE®	6	6
52	26109-331	SIDE PANEL - CRESENT LEFT	PANNEAU LATERAL - GAUCHE	2	2
53	26109-311	SIDE PANEL - CRESENT RIGHT	PANNEAU LATERAL - DROITE	2	2
54	26305-301	LID - OUTER PANEL	COUVERCLE - PANNEAU EXTERIEUR	1	1
54A	26303-301	LID - OUTER PANEL	COUVERCLE - PANNEAU EXTERIEUR	1	1
55	26205-90	LID - INNER PANEL	COUVERCLE - PANNEAU INTERIEUR	1	1
55A	26203-90	LID - INNER PANEL	COUVERCLE - PANNEAU INTERIEUR	1	1
56	26005-34	HANDLE	POIGNÉE	1	1
56A	26003-34	HANDLE	POIGNÉE	1	1
57	26005-30	STRAP - HANDLE	COURROIE - POIGNÉE	1	1
57A	26003-30	STRAP - HANDLE	COURROIE - POIGNÉE	1	1
59	44089-60	NAMEPLATE	PLAQUE D'IDENTIFICATION	2	2
60	10571-6	HEAT INDICATOR	INDICATEUR DE CHALEUR	2	2
65	20005-000	MATCH LIGHT - STICK	ALLUMETTES	2	2
68	21175-131A	DOOR	PORTE	1	1
69	21175-111A	DOOR	PORTE	2	2
70	21475-138	HANDLE	POIGNÉE	3	3
78	21335-115	BRACKET - DOOR CATCH	CROCHET DE PORTE	1	1
78A	21333-925	BRACKET - DOOR CATCH	CROCHET DE PORTE	1	1
80	21109-905R	SIDE PANEL	PANNEAU LATERALE	3	3
82	25208-205	SHELF - CABINET	L'ETAGERE - LE CABINET	1	1
82A	25208-205R	SHELF - CABINET	L'ETAGERE - LE CABINET	1	1
83	21036-905R	CABINET SHELF SUPPORT	SUPPORT POUR L'ETAGERE	1	1
84	21526-375	BASE - TANK	TABLETTE INFERIEUR	1	•
85	21526-395	BRACKET - TANK BASE	SUPPORT DU RESERVOIR	2	•
86	Y-99101	SLIDE - TANK BASE	TIROIR TABLETTE DE BARBONE	1	•
88	21305-925R	PANEL - REAR	PANNEAU - ARRIÈRE	1	1
88A	25308-925R	PANEL - REAR	PANNEAU - ARRIÈRE	1	1

PARTS LIST / LISTE DES PIECES

KEY #	ITEM #	DESCRIPTION	DESCRIPTION	6771-84	6771-87
90	25098-955R	BASE	TABLETTE INFERIEURE	1	1
100	21039-911	BRACKET – CASTOR SUPPORT	SUPPORT DE ROULETTE	3	3
102	10892-23	CASTOR	ROULETTES	6	6
103	21009-955	BRACKET – CYLINDER LP	SUPPORT DU RESERVOIR PL	1	•
110	23030-635	SHELF BRACKET	SUPPORT POUR TABLETTE	2	2
111	23030-615	SHELF BRACKET	SUPPORT POUR TABLETTE	2	2
114	23101-614	SHELF	PLANCHETTE LATERALE	1	1
115	23100-654	SHELF-SIDEBURNER	PLANCHETTE – BRÛLEUR DE CÔTÉ	1	1
116	23401-631	SHELF FRONT	PLANCHETTE FRONTALE	1	1
116A	23401-611	SHELF FRONT	PLANCHETTE FRONTALE	1	1
117	23009-608	SHELF STRAP	FIXATION PLAQUETTE	2	2
124	23000-271	SHELF-SIDE BURNER	PLANCHETTE LATERAL DU BRÛLEUR	1	1
125	23000-254	COVER-SIDE BURNER	COUVERCLE LATERAL DU BRÛLEUR	1	1
126	23909-20	SIDE BURNER	BRÛLEUR DE CÔTÉ	1	1
128	23009-98	GRID	GRILLE	1	1
130	27905-354	BURNER ROTISSERIE	BRÛLEUR DE TOURNEBROCHE	1	1
131	10693-109	REAR BURNER-ORIFICE	ORIFICE DU BRÛLEUR ARRIÈRE	1	•
	10693-160	REAR BURNER-ORIFICE	ORIFICE DU BRÛLEUR ARRIÈRE	•	1
133	S15271	HANDLE	POIGNEE	1	1
134	S15270	BALANCER	CONTREPOIS	1	1
135	S15299	WASHER	RONDELLE	1	1
136	S15263	BUSHING	COL	1	1
137	S15260	SPIT ROD	BROCHETTE	1	1
138	S15287	4 PRONG FORKS	FOURCHETTE A 4 FOURCHON	1	1
139	57039-901	ROTISSERIE BRACKET	SUPPORT	1	1
140	S21125	SCREW #8 X 1/2	VIS #8 X 1/2	34	34
143	Y-12855	BOLT 1/4-20 X 3/8	BOULON 1/4-20 X 3/8	76	76
144	Y-12220	BUSHING	DOUILLE	1	1
145	S21235	HINGE PIN	GOUPILLE DE CHARNIÈRE	2	2
145A	10240-17	HINGE PIN	GOUPILLE DE CHARNIÈRE	1	1
146	S21233	HITCH PIN CLIP	ATTACHE DE CHEVILLE	9	9
147	Y-11231	LID BUMPER	BUTOIR DU COUVERCLE	8	8
148	10240-20	DOOR PIN	GOUPILLE DE LA PORTE	3	3
149	10240-19	DOOR PIN	GOUPILLE DE LA PORTE	3	3
150	Y-12124	DOOR PIN CAP	BOULON DE MAITIEN DE PORTE	3	3
152	Y-12222	MAGNET	AIMANT	3	3
153	Y-12223	SNAP IN MAGNET	AIMANT	3	3
154	Y-11560	SCREW 1/4-20 X 1-1/2	VIS 1/4-20 X 1-1/2	12	12
155	S21124	SCREW #8 X 1/2	VIS #8 X 1/2	39	39
156	Y-11793	NUT 1/4-20	ECROU 1/4-20	14	14
157	Y-12835	SCREW #6-32 X 1/4	VIS #6-32 X 1/4	3	3
158	Y-12646	SCREW - SHOULDER #8 X 1/2	VIS #8 X 1/2	2	2
160	Y-29304	BOLT #10-24 X 3/8	BOULON #10-24 X 3/8	54	54
161	Y-29310	SCREW #10-24 X 3/4	VIS #10-24 X 3/4	8	8
162	Y-29307	NUT #10-24	ECROU #10-24	4	4
163	S35094	SCREW #10-24 X 5/8	VIS #10-24 X 5/8	8	8
164	S21084	SCREW #14 X 5/8	VIS #14 X 5/8	6	6
165	Y-12127	DOOR CLIP	TROMBONE DE PORTE	3	3
167	Y-11987	BOLT 1/4-20 X 1	BOULON 1/4-20 X 1	8	8
168	Y-11208	WASHER	RONDELLE	2	2
169	S21061	WING NUT	ECROU PAPILLON	2	2
171	S15236	MOTOR	MOTEUR	1	1
173	S21362	SPRING	RESSORT	1	1
174	S21255	WASHER	RONDELLE	2	2
175	Y-11546	SCREW - SHOULDER 1/4-20 X 5/8	VIS 1/4-20 X 5/8	2	2
178	Y-11795	NUT 1/4-20	ECROU 1/4-20	2	2
181	25070-90	LIGHT SWITCH	COMMUTATEUR LEGER	1	1
182	25020-71	OVEN LIGHT	LUMIERE DE FOUR	3	3
183	25090-90	POWER BAR	BARRE ELECTRIQUE	1	1
184	25080-90	TRANSFORMER	TRANSFORMATEUR	1	1
185	25030-71	WIRE - OVEN LIGHT	LE FIL - LUMIERE DE FOUR	1	1
185A	25030-70	WIRE - OVEN LIGHT	LE FIL - LUMIERE DE FOUR	1	1
186	Y-12865	SCREW 1/4-20 X 3/4	VIS 1/4-20 X 3/4	47	43
187	Y-12857	WASHER	RONDELLE	6	6
188	S35095	SCREW #10-24 X 5/9	VIS #10-24 X 5/9	2	2

