

This Owner's Manual is provided and hosted by [Appliance Factory Parts](#).

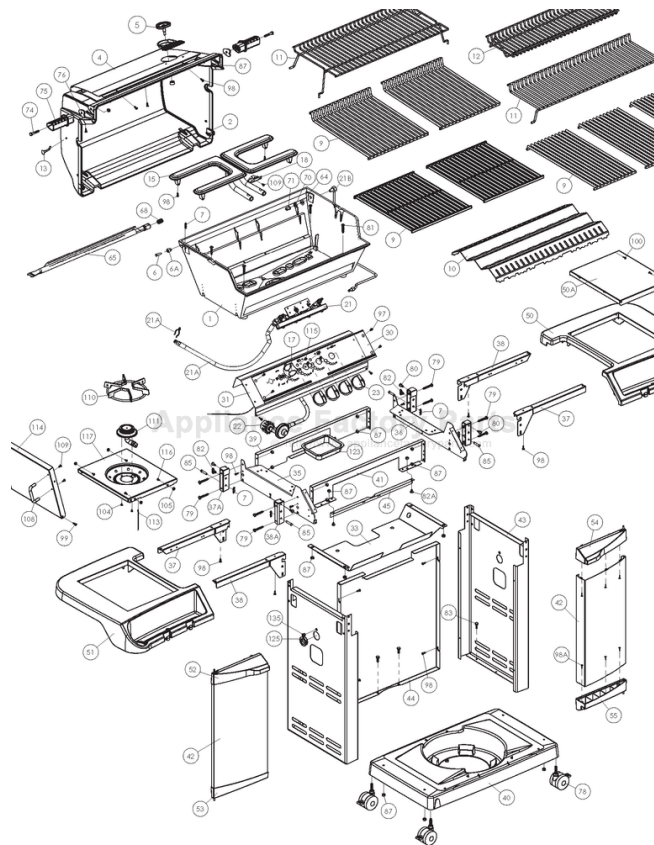

Broil-Mate 8684-4 Owner's Manual

[Shop genuine replacement parts for Broil-Mate 8684-4](#)



[Find Your Broil-Mate Grill Parts - Select From 682 Models](#)

----- Manual continues below part list -----

Available Replacement Parts for Broil-Mate 8684-4

| | |
|----------------------------|--|
| 03200 | spark generator; Bmstr, DCS, Ducane |
| 14625 | warming rack universal, 15 x 6.5 |
| 10696-160 | ORIFICE HOOD R/B 0.160MM NG |
| 18627GC | BURNER, DUAL 50,000 BTU |
| 10225-T627 | GRID SWING BASKET IMPERIAL BLACK |
| 10225-T528 | GRID FLAT WARM RACK T50 PORC + |
| 18488 | FLAV-R-WAVE - 50,000 BTU STAINLESS |
| S15500 | IGNITOR ELECTRODE ASSY H B H BURNER |
| 18013 | LARGE PROBE HEAT INDICATOR |
| 10240-15 | HINGE PIN SIDE SHELF DROP DOWN |
| S21237 | HINGE PIN SPACER |
| 10892-15 | CASTER 2 1/2 INCH WHEEL KNURLED |
| S21124 | SCREW PHCP #8 X 12 + |
| PB20-60A | S/B LID HANDLE WAGON ENCLOSURE+ W/SCREWS |
| 10390-E10 | BURNER SIDE 10BTU W/ELEC #8 + |
| 10342-T14 | WIRE ELECTRODE S/B FLAT/ROUND+ |
| 10239-7 | HANDLE GASKET TRIANGULAR 1/8 |
| Y-12220 | S/B BUSHING SB 1.375 16 HEY |
| 50416 | SMALL DRIP PAN - 10 PACK |
| S14019 | NAMEPLATE BROILMATE LG FLSH + |
| 10184-E461 | SHELF SUPPORT LHS BLK |
| S11426 | BOTTOM CASTING R/B + 2500/2700/400/700 |
| S11250 | CASTING TOP + |
| 02342 | control knob; universal |
| 10342-244 | IGNITOR ELECTRONIC + |
| 11225GC | CI COOKING GRID SET OF 2 |
| 10711-E561 | SHELF RHS EZ BILT W/O BRACKET |
| 10194-E501 | CONTROL COVER W/HS LARGE BLACK |
| 10225-T09 | GRID PORCELAIN ROUND S/B |
| 10184-e78A | END CAP DOOR TOP LHS W/MAGNET |

| | |
|-----------------------------|--|
| 10184-e76 | END CAP DOOR BOTTOM LEFT A |
| 10184-e79a | END CAP DOOR TOP RHS W/MAGNET |
| 10184-E401 | SUPPORT CASTING L BLK |
| 10110-94 | TUBE-REAR BRNR FIT ASSY |
| 10696-109 | ORIFICE HOOD R/B 0.109MM LP |
| 10442-T63 | CONTROL ASSEMBLY 50M/10M/15M 4V NG |
| 10184-R80 | RADIATION SHIELD RAW |
| 10184-E62 | SHELF SUPPORT BRACKET LHS + |
| 10184-E63 | SHELF SUPPORT BRACKET RHS + |
| 10958-E761 | PANEL SIDE BLACK + |
| 10958-E901 | PANEL REAR BLACK 21 3/4 INCH NEW 2006 |
| 10184-E77 | END CAP DOOR BOTTOM RIGHT A |
| S13005A | BURNER TUBULAR W/IGNITION |
| 10711-E562 | SHELF LEFT EZ-BILT W/O BRACKET |
| 10696-127 | R/B ORIFICE LP |
| 10696-185 | R/B ORIFICE NG 1.85MM |
| 11228 | CI COOKING GRIDS SET OF 2 |
| 10909-T50 | CASTING BOTTOM 52M 2002 + |
| 10473-T50 | CASTING TOP 52M |
| Y-11797 | BOLT SWING BASKET #D |
| 10711-E563 | SHELF SB EZ-BILT W/O BRACKET |
| 10958-e79lw | DOOR SMALL LHS CABINET ASSY + |
| 10472-k40 | KNOB ROTARY IGNITOR #B |
| 10393-e401 | SIDE BURNER COVER SIGNET |
| 10194-E545 | CONTROL COVER 2V LRG BLK CHRM |
| S12033 | GRID PORCELAIN T50 HEAVY 1 OF 3 |
| CG21SS | Cooking Grid Stainlss st Warm Morning G4 |
| 80012 | regulator and hose READ ADD. INFO |
| 10342-245 | IGNITOR ELECTRONIC DUAL + |
| S12206 | WARMING RACK 2500 1998 + |
| 10184-E991 | DOOR CATCH BRACKET |
| 11151 | SS COOKING GRID - SOVEREIGN |
| 10111-K45 | HOSE 3/8 INCH ASSEMBLY NG 10 FOOT + |

[Y-11990](#)

NUT HEX BRASS 3/8 27 RB LINE

broil-mate™

REDDI-BILT BARBECUES

ASSEMBLY MANUAL & PARTS LIST

MANUEL DE MONTAGE & LISTE DE PIÈCES



broil-mate™

4674-4
4674-7

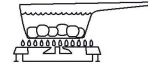

broil-mate™

4684-4
4684-7

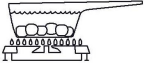

broil-mate™

4685-4
4685-7

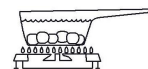

broil-mate™

4687-4
4687-7



broil-mate™

8674-4
8674-7

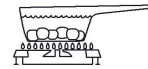

broil-mate™

8684-4
8684-7

RETAIN FOR FUTURE REFERENCE

VEUILLEZ CONSERVER POUR REFERENCE ULTERIEURE

1-800-265-2150

info@omcbbq.com

Onward
MANUFACTURING COMPANY
SINCE 1906
585 KUMPF DRIVE
WATERLOO, ONTARIO, CANADA
N2V 1K3

S18678 01/05

1

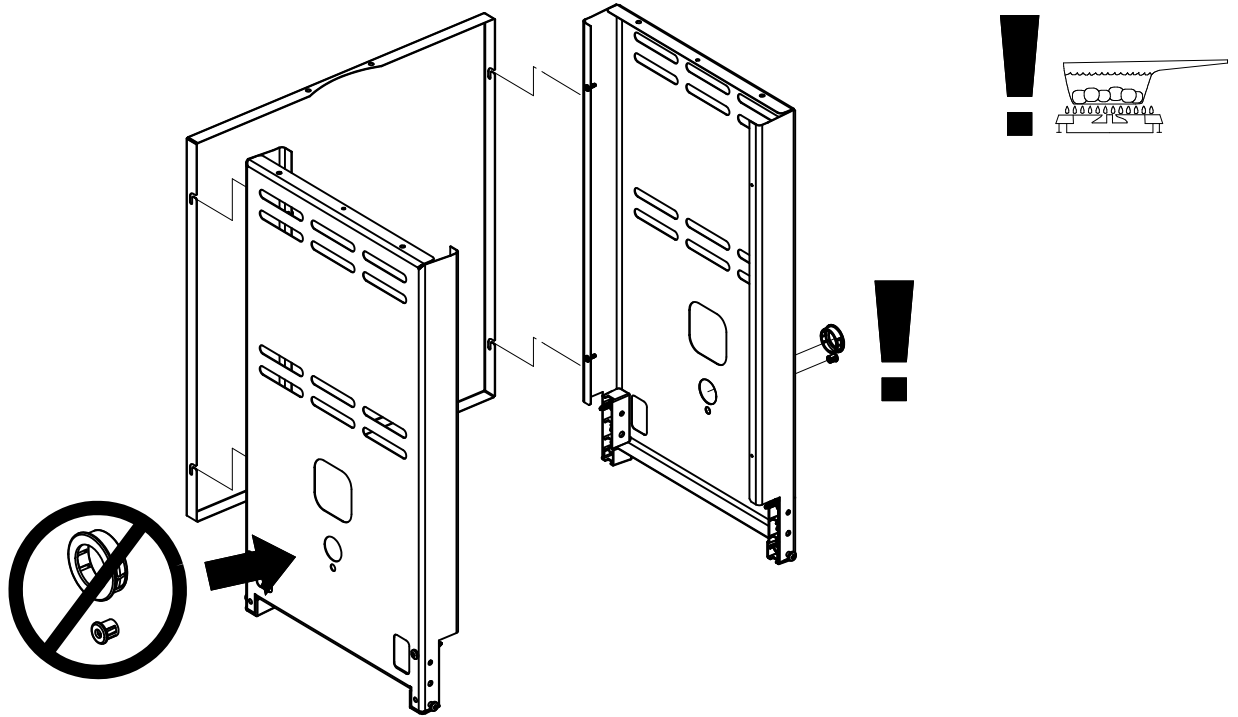
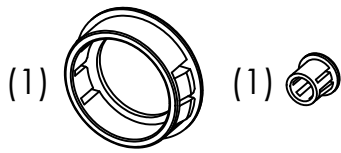

2

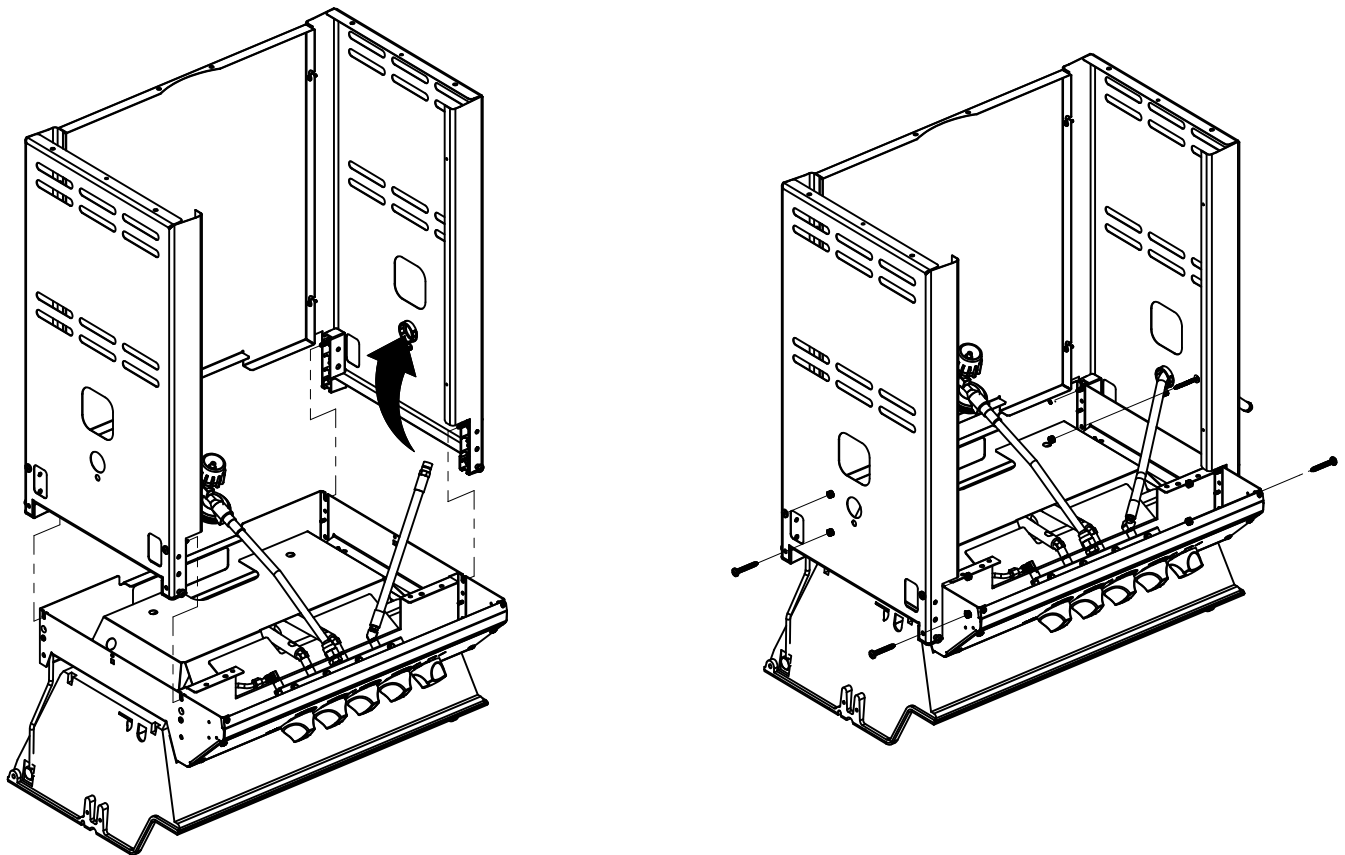
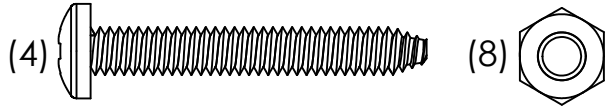

3

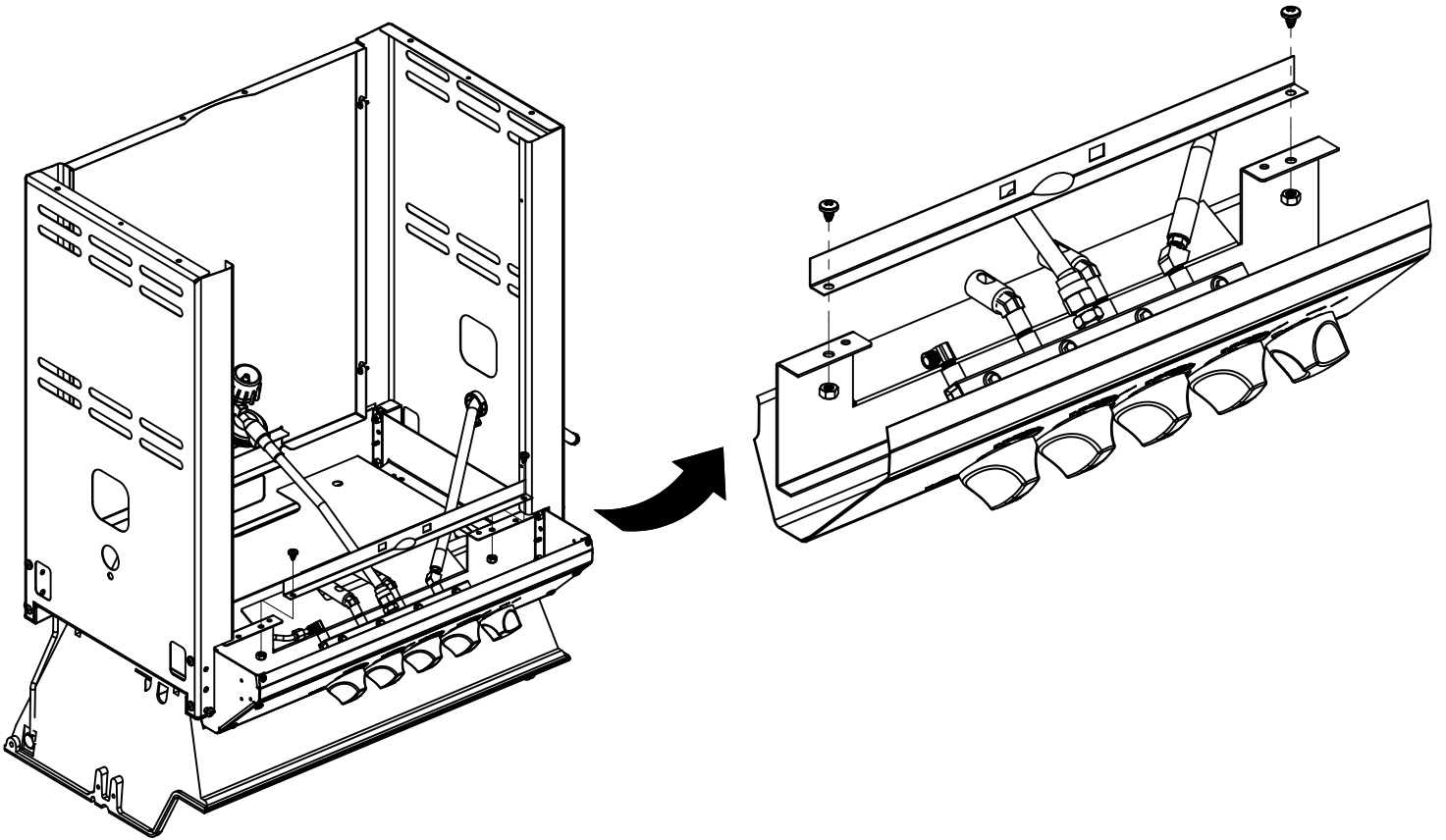
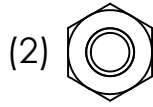
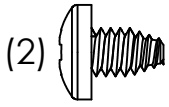

4

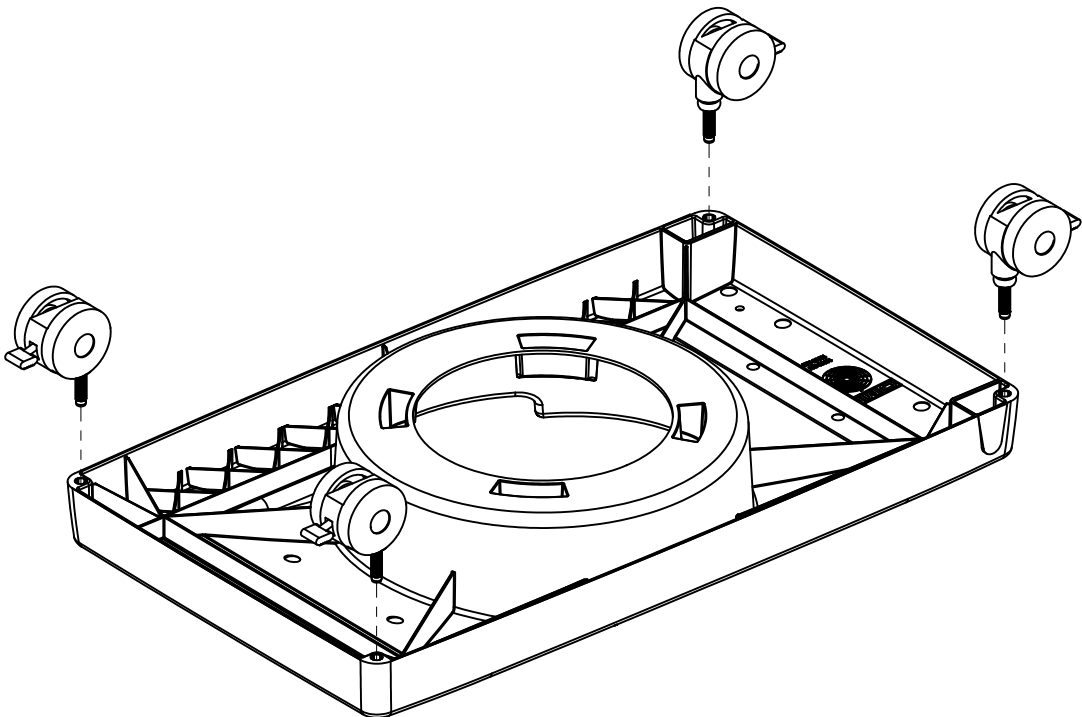

5

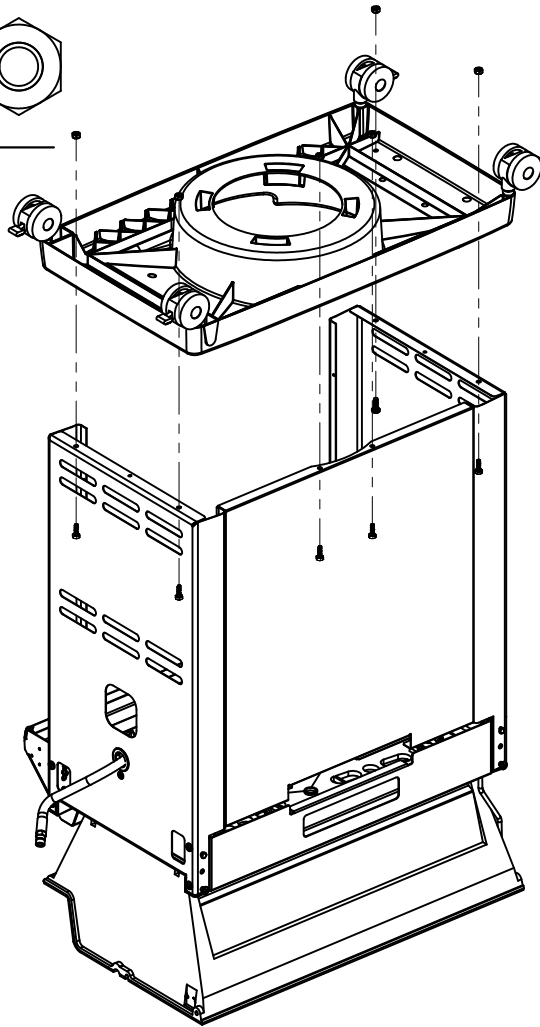
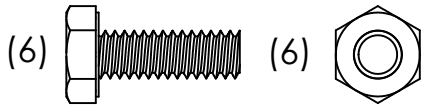

6

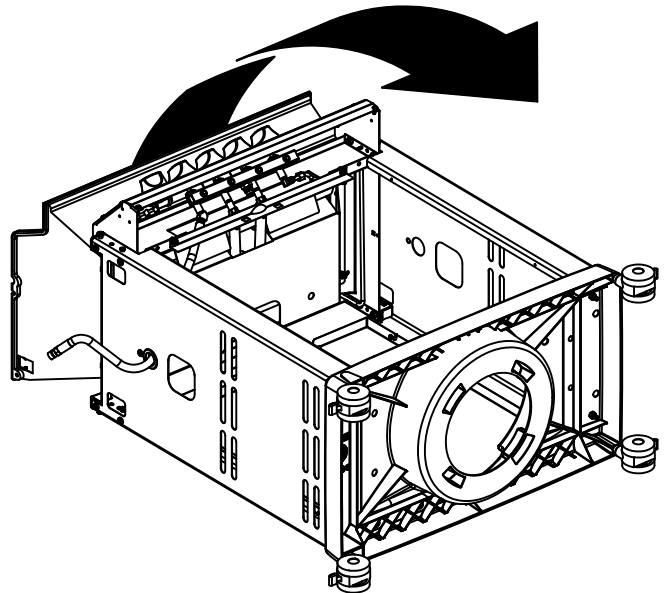
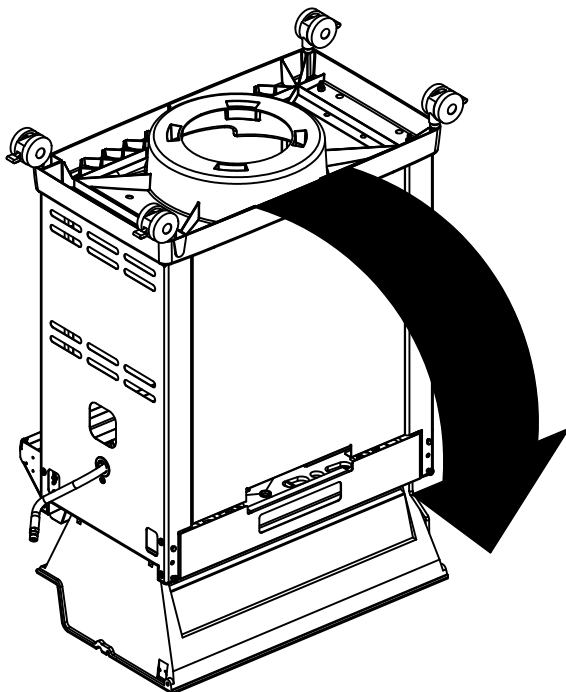

7

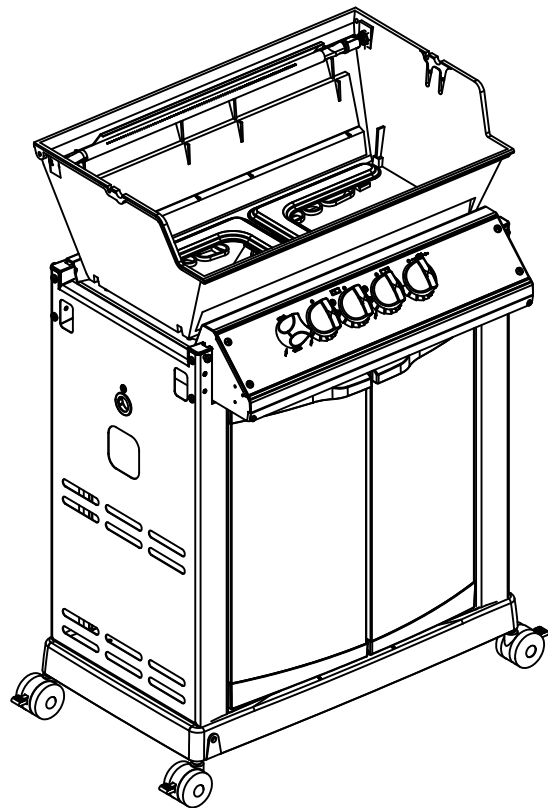
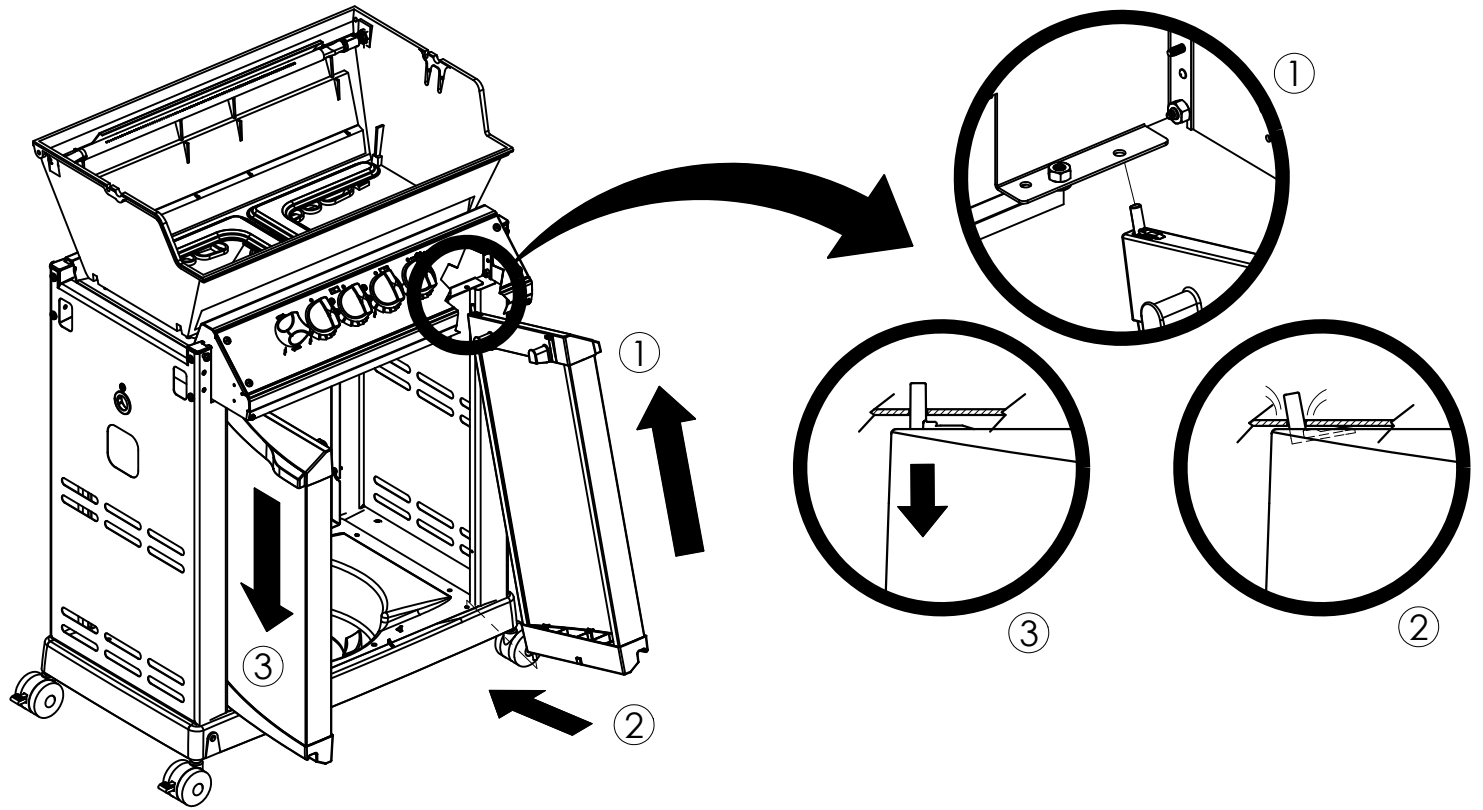

8

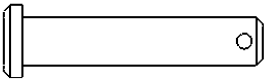
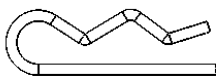
(2)  (2) 

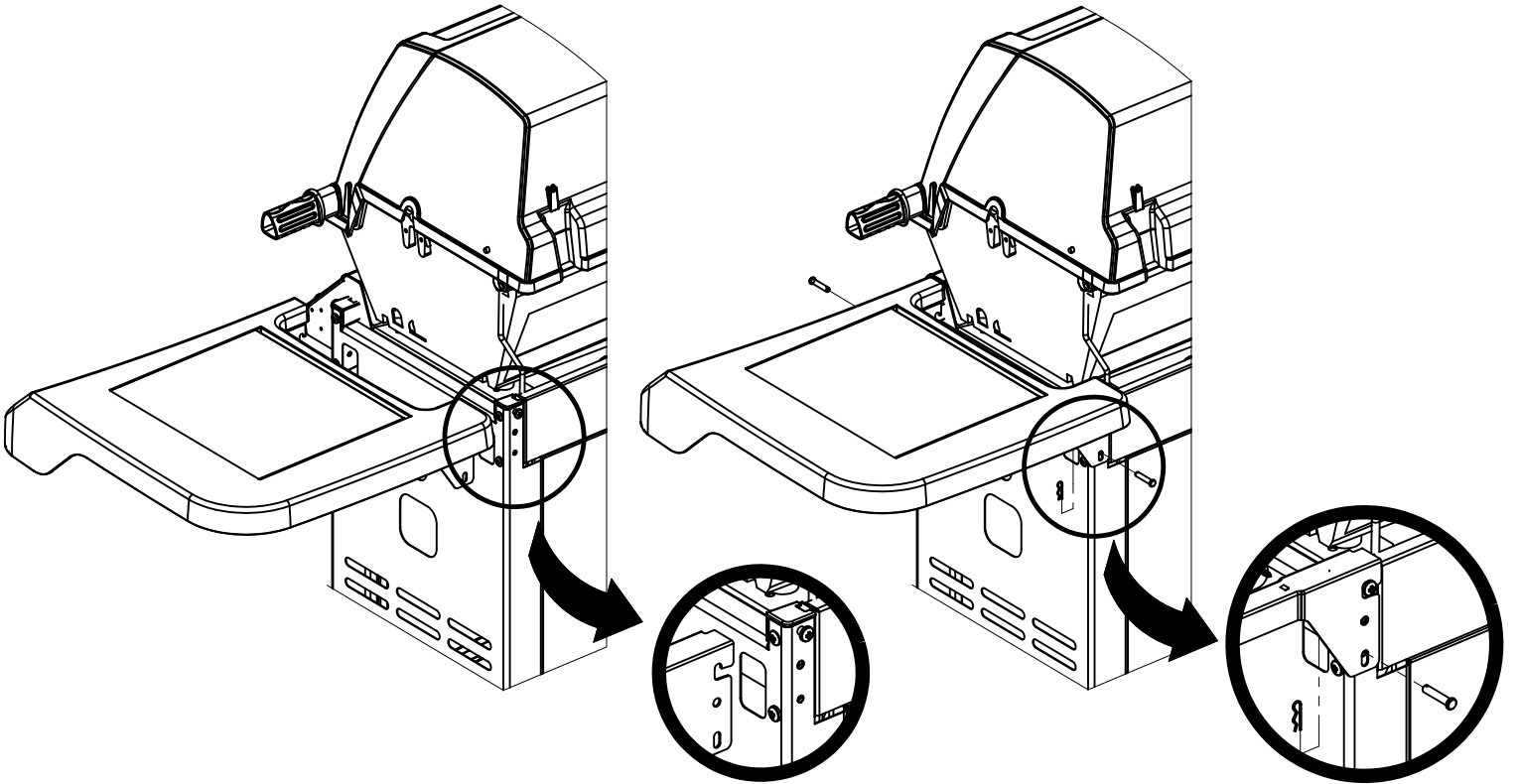

9

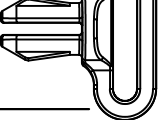
(1) 

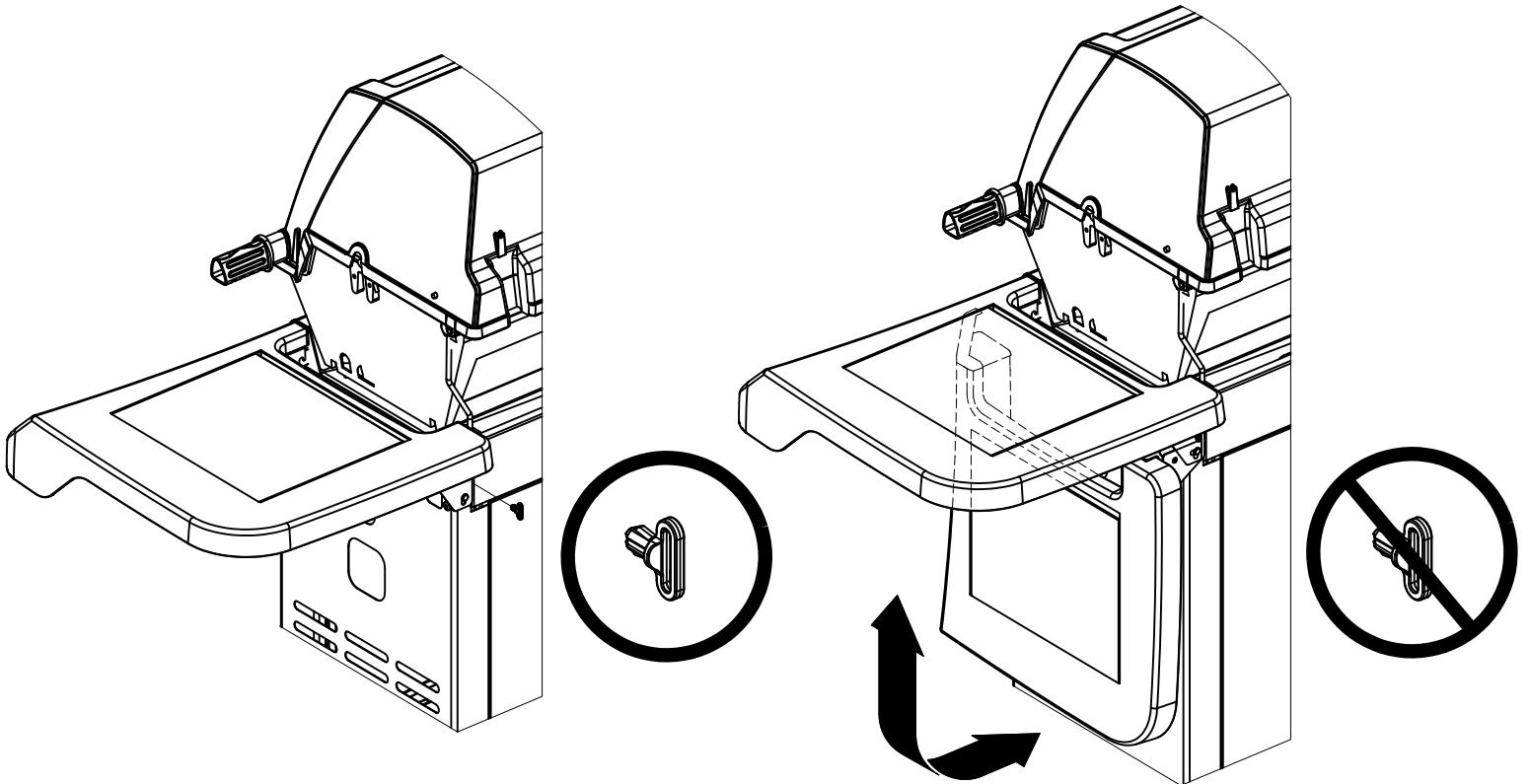

10

(2)

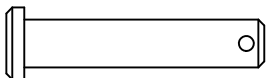

(2)

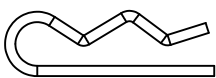

(1)

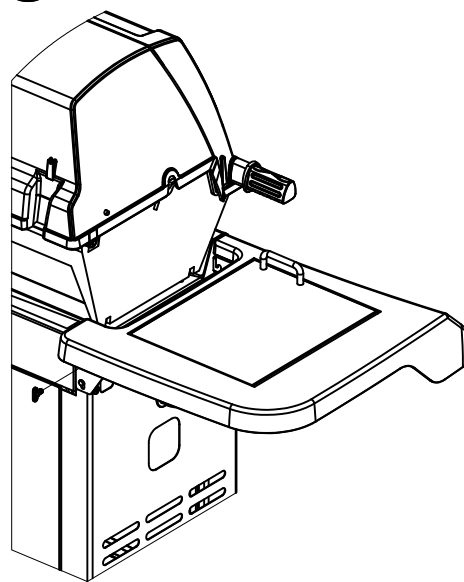
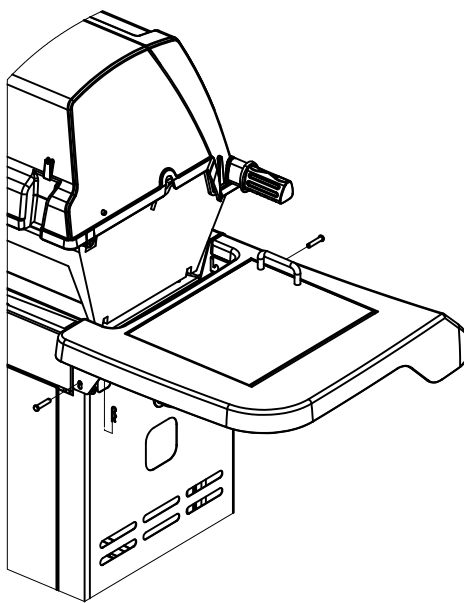
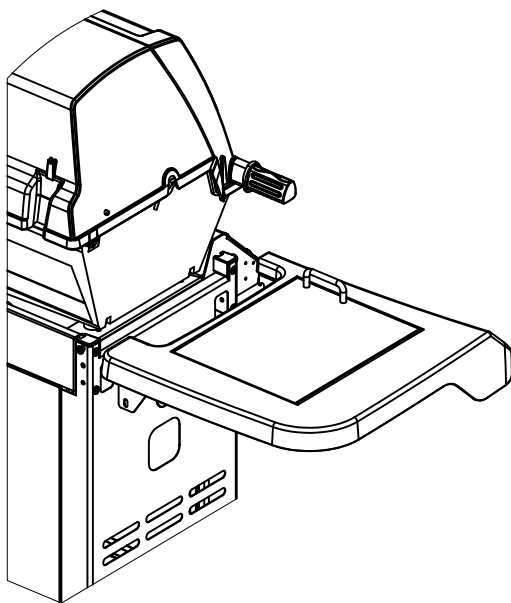
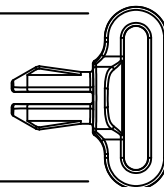

11

(1)

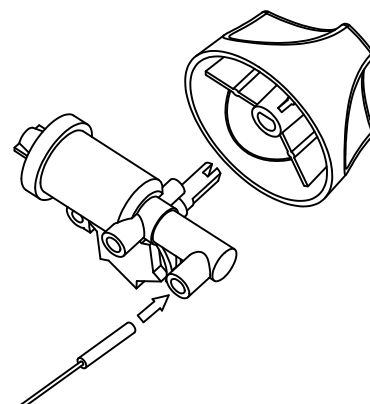
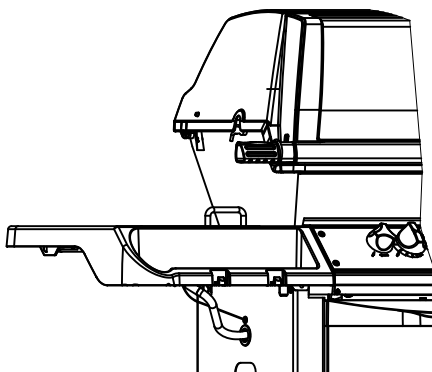
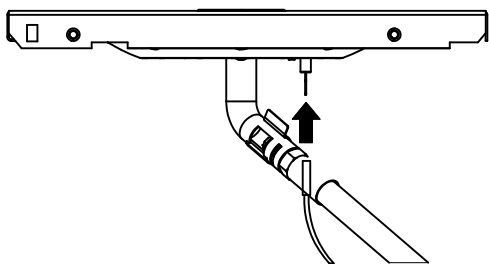
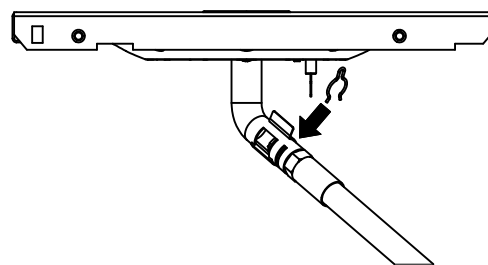
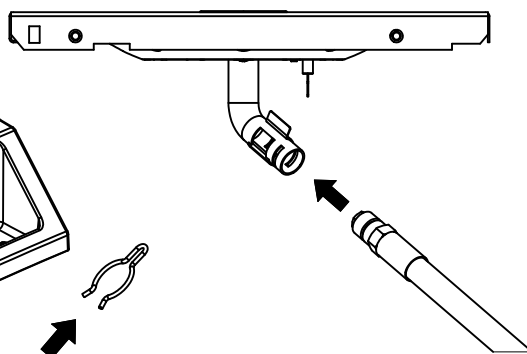
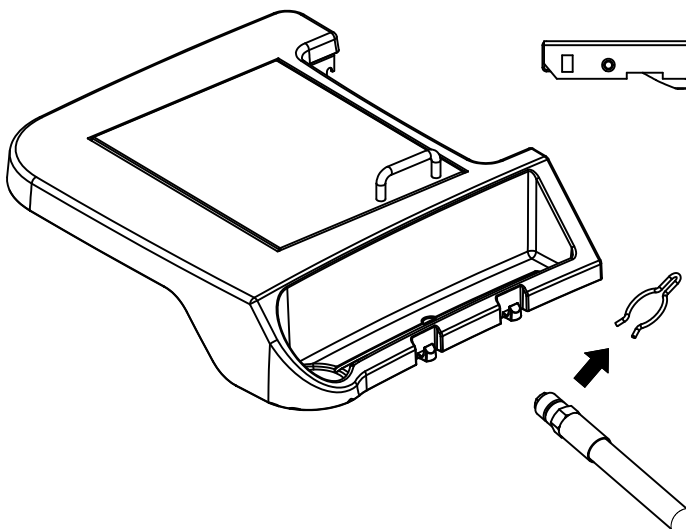
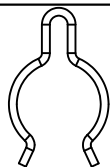

13

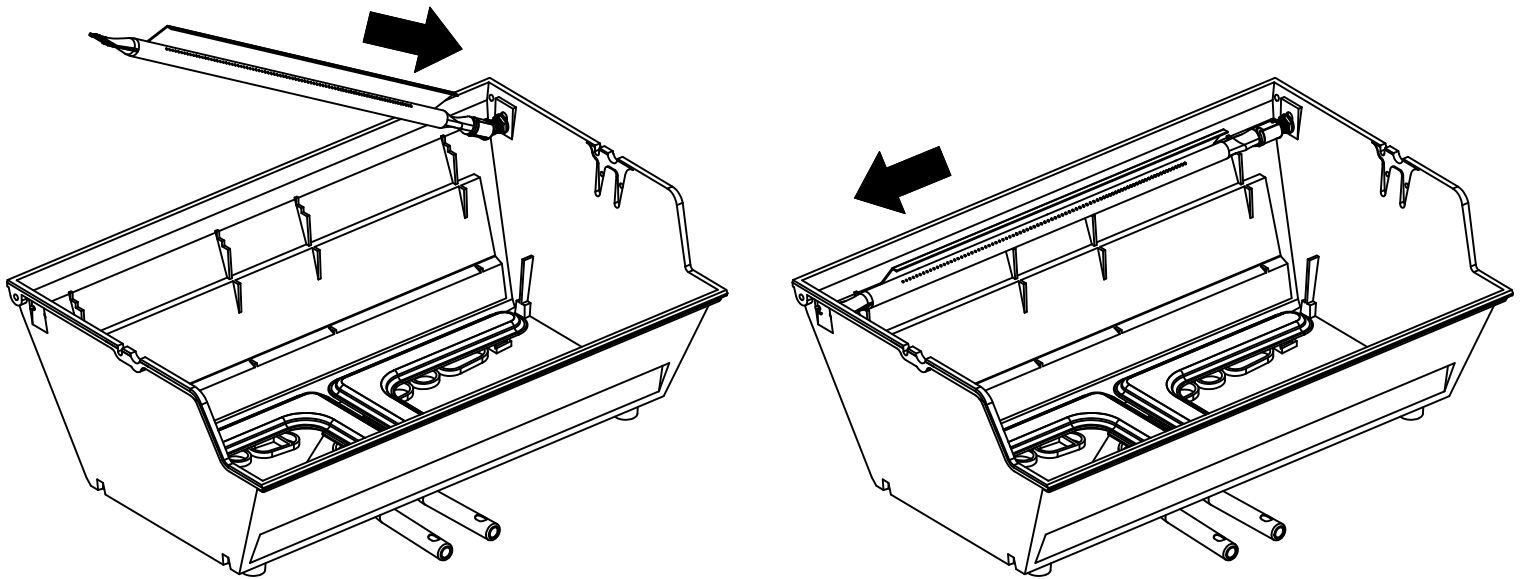

14

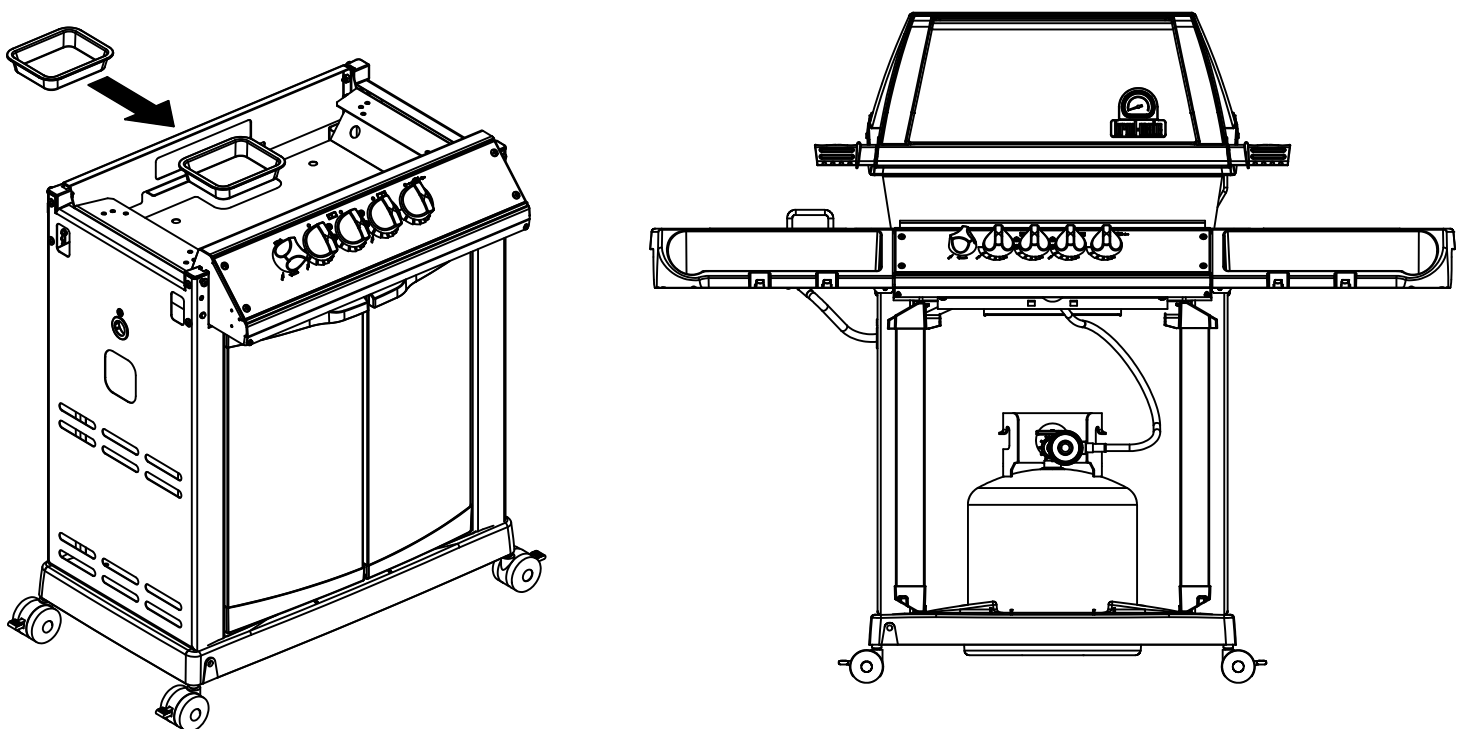

PARTS LIST / LISTE DES PIÈCES

| KEY # | ITEM # | DESCRIPTION | DESCRIPTION | 4674-4 | 4684-4 | 4685-4 | 4687-4 | 8674-4 | 8684-4 |
|-------|------------|----------------------------|--------------------------------|--------|--------|--------|--------|--------|--------|
| | | | | 4674-7 | 4684-7 | 4685-7 | 4687-7 | 8674-7 | 8684-7 |
| 1 | S11426 | CASTING BOTTOM | FOND DU FOYER | 1 | 1 | 1 | 1 | . | . |
| | 10909-T50 | CASTING BOTTOM | FOND DU FOYER | . | . | . | . | 1 | 1 |
| 2 | S11250 | CASTING TOP | COUVERCLE DU GRIL | 1 | 1 | 1 | 1 | . | . |
| | 10473-T50 | CASTING TOP | COUVERCLE DU GRIL | . | . | . | . | 1 | 1 |
| 3 | S14019 | NAMEPLATE | PLAQUE D'IDENTIFICATION | 1 | 1 | 1 | 1 | 1 | 1 |
| 4 | 10958-K69 | TOP CASTING INSERT | PANNEAU DE COUVERCLE | 1 | 1 | 1 | 1 | . | . |
| | 10958-K70 | TOP CASTING INSERT | PANNEAU DE COUVERCLE | . | . | . | . | 1 | 1 |
| 5 | 10571-6 | HEAT INDICATOR | INDICATEUR DE CHALEUR | 1 | 1 | 1 | 1 | 1 | 1 |
| 6 | S21235 | HINGE PIN | GOUPILLE DE CHARNIÈRE | 2 | 2 | 2 | 2 | . | . |
| | 10240-15 | HINGE PIN | GOUPILLE DE CHARNIÈRE | . | . | . | . | 2 | 2 |
| 6A | S21237 | HINGE SPACER | ENTRETOISE DE CHARNIÈRE | . | . | . | . | 2 | 2 |
| 7 | S21233 | HITCH PIN CLIP | ATTACHE DE CHEVILLE | 6 | 6 | 6 | 6 | 6 | 6 |
| 9 | S12029 | GRID - PORCELAIN | GRILLE | 2 | 2 | . | . | . | . |
| | S12024 | GRID - S.S. | GRILLE - A.I. | . | . | 2 | . | . | . |
| | S12033 | GRID - PORCELAIN | GRILLE | . | . | . | . | 3 | 3 |
| | 10225-T406 | GRID - PORCELAIN | GRILLE | . | . | . | 2 | . | . |
| 10 | 10222-T424 | FLAV-R-WAVE | FLAV-R-WAVE | . | . | . | 1 | . | . |
| | 10222-T425 | FLAV-R-WAVE S.S. | FLAV-R-WAVE A.I. | 1 | 1 | 1 | . | 1 | 1 |
| 11 | S12206 | GRID - WARMING RACK | GRILLE | . | . | 1 | 1 | . | . |
| | S12207 | GRID - WARMING RACK | GRILLE | 1 | 1 | . | . | . | . |
| | 10225-T528 | GRID - WARMING RACK | GRILLE | . | . | . | . | 1 | 1 |
| 12 | 10225-T627 | SWING BASKET | PANIER À BALANCOIR | . | . | . | . | 1 | 1 |
| 13 | Y-11797 | BOLT - SWING BASKET | BOULON POUR PANIER A BALANCOIR | . | . | . | . | 2 | 2 |
| 15 | S10017 | BURNER/VENTURI ASSY | ENSEMBLE DE BRULEUR | 1 | 1 | 1 | 1 | 1 | 1 |
| 17 | 10342-242 | ROTARY IGNITOR | ALLUMEUR ROTATIF | . | . | 1 | 1 | . | 1 |
| | 10342-248 | ROTARY IGNITOR | ALLUMEUR ROTATIF | 1 | . | . | . | 1 | . |
| | 10472-K40 | ROTARY IGNITOR KNOB | BOUTON ROTATOIRE D'IGNITOR | 1 | 1 | 1 | 1 | 1 | 1 |
| | S21124S | SCREW - 8 x 1/2 S.S. | VIS - 8 X 1/2 S.S. | . | . | 2 | . | 2 | 2 |
| 18 | S15500 | ELECTRODE | ELECTRODE | 1 | 1 | 1 | 1 | 1 | 1 |
| 21 | 10440-T60 | CONTROL ASSY LP-3V | SOUPAPE, (GAZ PROPANE) | 1 | . | . | . | . | . |
| | 10440-T61 | CONTROL ASSY NG-3V | SOUPAPE, (GAZ NATUREL) | 1 | . | . | . | . | . |
| | 10440-T84 | CONTROL ASSY LP-3V | SOUPAPE, (GAZ PROPANE) | . | . | . | . | 1 | . |
| | 10440-T85 | CONTROL ASSY NG-3V | SOUPAPE, (GAZ NATUREL) | . | . | . | . | 1 | . |
| | 10442-T62 | CONTROL ASSY LP-4V | SOUPAPE, (GAZ PROPANE) | . | 1 | 1 | 1 | . | . |
| | 10442-T63 | CONTROL ASSY NG-4V | SOUPAPE, (GAZ NATUREL) | . | 1 | 1 | 1 | . | . |
| | 10442-T86 | CONTROL ASSY LP-4V | SOUPAPE, (GAZ PROPANE) | . | . | . | . | . | 1 |
| | 10442-T87 | CONTROL ASSY NG-4V | SOUPAPE, (GAZ NATUREL) | . | . | . | . | . | 1 |
| 21A. | S13467-091 | HOSE-SIDE BURNER LP | TUYAU DU BRULEUR LATERAL PL | . | 1 | 1 | 1 | . | 1 |
| | S13467-132 | HOSE-SIDE BURNER NG | TUYAU DU BRULEUR LATERAL GN | . | 1 | 1 | 1 | . | 1 |
| | Y-11230 | COTTER PIN | ATTACHE DE CHEVILLE | . | 1 | 1 | 1 | . | 1 |
| 21B. | 10110-94 | TUBE-REAR BURNER ASSY | TUBE DE BRULEUR ARRIERE | 1 | 1 | 1 | 1 | 1 | 1 |
| 22 | 10114-20 | HOSE & REGULATOR LP - QCC1 | TUYAU ET REGULATEUR PL - QCC1 | 1 | 1 | 1 | 1 | 1 | 1 |
| | 10111-K47 | HOSE NATURAL GAS | TUYAU (GAZ NATUREL) | 1 | 1 | 1 | 1 | 1 | 1 |
| 23 | 10472-K37 | CONTROL KNOB | BOUTON DE CONTROLE | 3 | 4 | 4 | 4 | 3 | 4 |
| 30 | 10086-E85 | DECO PLATE - 4V S.S. | PLAQUE DECORATIVE - 4V A.I. | . | . | 1 | . | . | 1 |
| | 10086-E524 | DECO PLATE - 3V | PLAQUE DECORATIVE - 3V | 1 | . | . | . | . | . |
| | 10086-E534 | DECO PLATE - 4V | PLAQUE DECORATIVE - 4V | . | 1 | . | 1 | . | . |
| | 10086-E721 | DECO PLATE - 3V S.S. | PLAQUE DECORATIVE - 3V A.I. | . | . | . | . | 1 | . |
| 31 | 10194-E501 | CONTROL COVER | PANNEAU DE CONTROLE | 1 | 1 | 1 | 1 | 1 | 1 |
| 33 | 10184-R801 | RADIATION SHIELD | ÉCRAN DE CHALEUR | 1 | 1 | 1 | 1 | 1 | 1 |
| 35 | 10184-E401 | SUPPORT-CASTING-LEFT | SUPPORT GAUCHE DU FOYER | 1 | 1 | 1 | 1 | 1 | 1 |
| 36 | 10184-E411 | SUPPORT-CASTING-RIGHT | SUPPORT DROIT DU FOYER | 1 | 1 | 1 | 1 | 1 | 1 |
| 37 | 10184-E461 | SUPPORT-SIDE SHELF-LEFT | SUPPORT TABLETTE DE GAUCHE | 2 | 2 | 2 | 2 | 2 | 2 |
| 37A | 10184-E62 | SUPPORT-SIDE SHELF-LEFT | SUPPORT TABLETTE DE GAUCHE | 2 | 2 | 2 | 2 | 2 | 2 |
| 38 | 10184-E471 | SUPPORT-SIDE SHELF-RIGHT | SUPPORT TABLETTE DE DROIT | 2 | 2 | 2 | 2 | 2 | 2 |
| 38A | 10184-E63 | SUPPORT-SIDE SHELF-RIGHT | SUPPORT TABLETTE DE DROIT | 2 | 2 | 2 | 2 | 2 | 2 |
| 39 | 10956-E561 | BRACE-REAR | SUPPORT ARRIERE | 1 | 1 | 1 | 1 | 1 | 1 |
| 40 | 10958-R82 | BASE | TABLETTE INFERIEURE | 1 | 1 | 1 | 1 | 1 | 1 |
| 41 | 10956-E571 | BRACE-FRONT | SUPPORT AVANT | 1 | 1 | 1 | 1 | 1 | 1 |
| 42 | 10958-E79 | DOOR | PORTE | 2 | 2 | 2 | 2 | 2 | 2 |
| 43 | 10958-E761 | SIDE PANEL BLK | PANNEAU LATERALE | 2 | 2 | 2 | 2 | 2 | 2 |
| 44 | 10958-E901 | PANEL - REAR | PANNEAU - ARRIÈRE | 1 | 1 | 1 | 1 | 1 | 1 |

PARTS LIST / LISTE DES PIÈCES

| KEY # | ITEM # | DESCRIPTION | DESCRIPTION | 4674-4 | 4684-4 | 4685-4 | 4687-4 | 8674-4 | 8684-4 |
|-------|------------|----------------------------|-------------------------------|--------|--------|--------|--------|--------|--------|
| | | | | 4674-7 | 4684-7 | 4685-7 | 4687-7 | 8674-7 | 8684-7 |
| 45 | 10184-E801 | BRACKET - DOOR CATCH | PARENTHÈSE - CROCHET DE PORTE | 1 | 1 | 1 | 1 | 1 | 1 |
| 50 | 10711-E561 | SHELF - SIDE - RIGHT | PLANCHETTE LATÉRALE – DROIT | 1 | 1 | . | . | . | . |
| | 10711-E564 | SHELF - SIDE - INSERT | PLANCHETTE LATÉRALE – DROIT | . | . | 1 | 1 | 1 | 1 |
| 50A | 10393-E52 | INSERT - SIDE SHELF | PANNEAU - ÉTAGÈRE LATÉRALE | . | . | 1 | 1 | 2 | 1 |
| 51 | 10711-E562 | SHELF-SIDE-LEFT | PLANCHETTE LATÉRALE – GAUCHE | 1 | . | . | . | . | . |
| | 10711-E563 | SHELF-SIDEBURNER | PLANCHETTE – BRULEUR DE COTE | . | 1 | 1 | 1 | 1 | 1 |
| 52 | 10184-E76 | DOOR - TOP CAP - LEFT | PORTE - DESSUS - GAUCHE | 1 | 1 | 1 | 1 | 1 | 1 |
| 53 | 10184-E78 | DOOR - BOTTOM CAP - LEFT | PORTE - LE FOND - GAUCHE | 1 | 1 | 1 | 1 | 1 | 1 |
| 54 | 10184-E77 | DOOR - TOP CAP - RIGHT | PORTE - DESSUS - DROIT | 1 | 1 | 1 | 1 | 1 | 1 |
| 55 | 10184-E79 | DOOR - BOTTOM CAP - RIGHT | PORTE - LE FOND - DROIT | 1 | 1 | 1 | 1 | 1 | 1 |
| 64 | Y-12851 | WASHER | RONDELLE | 1 | 1 | 1 | 1 | . | . |
| 65 | S13005 | BURNER ROTISSERIE | BRULEUR A ROTISS | . | . | . | . | 1 | 1 |
| | S13009 | BURNER ROTISSERIE | BRULEUR A ROTISS | 1 | 1 | 1 | 1 | . | . |
| 68 | S21362 | SPRING | RESSORT | 1 | 1 | 1 | 1 | 1 | 1 |
| 70 | Y-11990 | HEX NUT | ECROU | 1 | 1 | 1 | 1 | 1 | 1 |
| 71 | 10696-109 | REARBURNER-ORIFICE LP | ORIFICE DU BRULEUR ARRIERE PL | 1 | 1 | 1 | 1 | . | . |
| | 10696-127 | REARBURNER-ORIFICE LP | ORIFICE DU BRULEUR ARRIERE PL | . | . | . | . | 1 | 1 |
| | 10696-160 | REARBURNER-ORIFICE NG | ORIFICE DU BRULEUR ARRIERE GN | 1 | 1 | 1 | 1 | . | . |
| | 10696-185 | REARBURNER-ORIFICE NG | ORIFICE DU BRULEUR ARRIERE GN | . | . | . | . | 1 | 1 |
| 74 | Y-6616 | BOLT 1/4-20 X 1 1/2 | BOULON – 1/4-20 X 1 1/2 | 2 | 2 | 2 | 2 | 2 | 2 |
| 75 | 10338-145 | HANDLE | POIGNEE | 2 | 2 | 2 | 2 | 2 | 2 |
| 76 | 10239-7 | WASHER-HANDLE | RONDELLE DE LA POIGNEE | 2 | 2 | 2 | 2 | 2 | 2 |
| 78 | 10892-15 | CASTOR | ROULETTES | 4 | 4 | 4 | 4 | 4 | 4 |
| 79 | Y-11561 | BOLT – 1/4:20 x 1 3/4 | BOULON - 1/4:20 X 1 3/4 | 8 | 8 | 8 | 8 | 8 | 8 |
| 80 | Y-11546 | SCREW- 1/4-20 X 5/8 | VIS – 1/4-20 X 5/8 | 4 | 4 | 4 | 4 | 4 | 4 |
| 81 | Y-11545 | SCREW – 1/4-20 X 1 3/8 | VIS – 1/4-20 X 1 3/8 | 4 | 4 | 4 | 4 | 4 | 4 |
| 82 | Y-12673 | SHELF - LOCK PIN | ÉTAGÈRE - GOUPILLE DE SERRURE | 2 | 2 | 2 | 2 | 2 | 2 |
| 82A | Y-12855 | BOLT- 1/4-20 X 3/8 | BOULON – 1/4-20 X 3/8 | 2 | 2 | 2 | 2 | 2 | 2 |
| 83 | S21014 | BOLT- 1/4-20 X 3/4 | BOULON – 1/4-20 X 3/4 | 6 | 6 | 6 | 6 | 6 | 6 |
| 85 | 10240-15 | HINGE PIN | ATTACHE DE CHEVILLE | 4 | 4 | 4 | 4 | 4 | 4 |
| 87 | Y-11793 | NUT- 1/4-20 | ECROU – 1/4-20 | 22 | 22 | 22 | 22 | 24 | 24 |
| 97 | Y-12642 | SCREW – 8 X 1/2 - S.S. | VIS - 8 X 1/2 - A.I. | . | . | 6 | . | 6 | 6 |
| | Y-12643 | SCREW – 8 X 1/2 | VIS - 8 X 1/2 | 6 | 6 | . | 6 | . | . |
| 98 | S21124 | SCREW – 8 X 1/2 | VIS - 8 X 1/2 | 20 | 20 | 20 | 20 | 20 | 20 |
| 98A | Y-12643 | SCREW – 8 X 1/2 | VIS - 8 X 1/2 | 12 | 12 | 12 | 12 | 12 | 12 |
| 99 | Y-12646 | SCREW – SHOULDER 8 X 1/2 | VIS - 8 X 1/2 | . | 2 | 2 | 2 | . | 2 |
| 100 | S21126 | SCREW – 8 X 1/2 | VIS - 8 X 1/2 | . | . | 4 | 4 | 8 | 4 |
| 104 | Y-12835 | SCREW – 6-32 X 1/4 | VIS – 6-32 X 1/4 | . | 2 | 2 | 2 | . | 2 |
| 105 | Y-29307 | NUT – 10-24 | ECROU – 10-24 | . | 4 | 4 | 4 | . | 4 |
| 108 | PB20-60 | LID HANDLE | POIGNEE | . | 1 | 1 | 1 | . | 1 |
| 109 | S21136 | SCREW – 8-32 X 3/8 | VIS – 8-32 X 3/8 | 1 | 3 | 3 | 3 | 1 | 3 |
| 110 | 10225-T09 | GRID | GRILLE | . | 1 | 1 | 1 | . | 1 |
| 111 | 10390-E10 | SIDE BURNER | BRULEUR DE COTE | . | 1 | 1 | 1 | . | 1 |
| 113 | 10342-T14 | ELECTRODE – SIDE BURNER | ELECTRODE – BRULEUR DE COTE | . | 1 | 1 | 1 | . | 1 |
| 114 | 10393-E50 | COVER-SIDE BURNER | COUVERCLE LATÉRAL | 1 | . | 1 | 1 | 1 | 1 |
| | 10393-E401 | COVER-SIDE BURNER | COUVERCLE LATÉRAL | . | 1 | . | . | . | . |
| 115 | Y-29304 | SCREW – 10-24 X 3/8 | VIS– 10-24 X 3/8 | 4 | 4 | . | 4 | . | . |
| | Y-29304S | SCREW – 10-24 X 3/8 - S.S. | VIS– 10-24 X 3/8 - A.I. | . | . | 4 | . | 4 | 4 |
| 116 | Y-29304 | SCREW – 10-24 X 3/8 | VIS– 10-24 X 3/8 | . | 4 | 4 | 4 | . | 4 |
| 117 | 10393-E62 | SHELF-SIDE BURNER | SUPPORT DE BRULEUR DE COTE | . | 1 | 1 | 1 | . | 1 |
| 123 | S15115 | GREASE PAN - DISPOSABLE | CUVETTE A GRAISSE | 2 | 2 | 2 | 2 | 2 | 2 |
| 125 | Y-12220 | BUSHING | DOUILLE | 1 | 1 | 1 | 1 | 1 | 1 |
| 135 | Y-12119 | 3/8 HEYCO BUSHING | DOUILLE DE 3/8 HEYCO | 1 | 1 | 1 | 1 | 1 | 1 |

