

This Owner's Manual is provided and hosted by [Appliance Factory Parts](#).



Sterling 581264B Owner's Manual

[Shop genuine replacement parts for Sterling 581264B](#)



[Find Your Sterling Grill Parts - Select From 509 Models](#)

----- Manual continues below part list -----

Available Replacement Parts for Sterling 581264B

S21233	HITCH PIN CLIP +
Y-12860	SCREW-THCP 1/4-20 X 1-TY-C A04
Y-11793	NUT HEX 1/4 20 JS500 +
Y-12835	SCREW-PHCP 6-32X1/4 TY-F JS500
Y-29307	NUT HEX #10-24 JS500
10240-13	WHEEL PIN
Y-11230	HAIRPIN COTTER SIDE BURNER +
Y-11546	SCREW PHCP 1/4-20X5/8 INCH A04#A
S21124	SCREW PHCP #8 X 12 +
10390-E10	BURNER SIDE 10BTU W/ELEC #8 +
Y-29304	SCREW PHCP #10 24x3/8
S21125	SCREW 8 X 3/8 PAN HEAD
S35094	SCREW #10-24 X 5/8
10342-246	IGNITOR ELECTRONIC TRIPLE +
Y-11231	LID BUMPER ROUND BLK
10342-E13	ELECTRODE W/WIRE
10342-T18	WIRE ELECTRODE S/B 600 +
18431	FLAV-R-WAVE - BARON - SS
52007-181	COOKING GRID 550 PORC BLK +
10240-23	LID PIN 1/4-20
Y-29310	SCREW #10-24 3/4 TRUSS QU
20005-000	HARDWARE BAG STICK & CHAIN SS
80012	regulator and hose READ ADD. INFO
10342-245	IGNITOR ELECTRONIC DUAL +
10892-608	WHEEL 6 INCH
22049-102	GREASE TRAY BRACKET GAL 330/440/550
24004-12A	LID HANDLE BENT 330 430SS
51429-158	RESIN FOOT 330/440
53184-118	SHELF END CAP RHS 330/440
53184-138	SHELF END CAP LHS 330/440

53404-114	SHELF FRONT FACIA RHS 330/440
57154-901	GREASE TRY 340/401 0.8MM BLK HI HEAT PNT
59004-014	VALVE ASSY 330 3V LP
59004-017	VALVE ASSEMBLY 3V NG
59004-034	VALVE ASSEMBLY 3V+SB LP
59004-037	VALVE ASSEMBLY 3V+SB NG
53009-951	SIDE BURNER TRIVET BLK
Y-11235	LID BUMPER HEX-BLK AB
Y-12865	SCREW 1/4 X 20X1/2 TYPE-C PHCP
18010	LID HEAT INDICATOR - SMALL - SS
52004-091	WARMING RACK PORC BLK 330
52249-404	HEAT TENT SS
53104-111	SHELF RHS BLK 330/440
S21242	CLIP BURNER TUBE MOUNT SS
52924-144R	BURNER - MAIN
Y-11544S	SCREW - BURNER #10-24 X 3/8
10111-K45	HOSE 3/8 INCH ASSEMBLY NG 10 FOOT +
24009-936	HANDLE RING
10472-K431	CONTRL KNOB RESIN LRG BLCK W/SS BA STRIP
22001-168	CONTROL KNOB BEZEL SML
22002-268	CONTROL KNOB BEZEL LARGE
52009-901	GREASE PAN - BLACK HIGH HEAT PAINT
52904-144NG	BURNER ASSY MAIN SINGLE TUBE + NG
27249-904	GREASE SHIELD MODULAR, 6.5 x 6

OMC

ASSEMBLY MANUAL & PARTS LIST • MANUEL DE MONTAGE & LISTE DE PIÈCES • MANUAL DE ARMADO Y LISTA DE PARTES



STERLING 6
581264B
581267B
HUNTINGTON™
681264B
681267B
broil-mate™
781264B
781267B



STERLING 6
581264
581267
HUNTINGTON™
681264
681267
broil-mate™
781264
781267



STERLING 6
581254B
581257B
HUNTINGTON™
681254B
681257B
broil-mate™
781254B
781257B



STERLING 6
581254
581257
HUNTINGTON™
681254
681257
broil-mate™
781254
781257

RETAIN FOR FUTURE REFERENCE • VEUILLEZ CONSERVER POUR REFERENCE ULTERIEURE • CONSERVAR PARA FUTURAS CONSULTAS

1-800-265-2150

info@omcbbq.com

Onward
MANUFACTURING COMPANY

SINCE 1906

1000 EAST MARKET STREET
HUNTINGTON, INDIANA, 46750, USA

50084-C34 Rev B 10/15

1

(4)

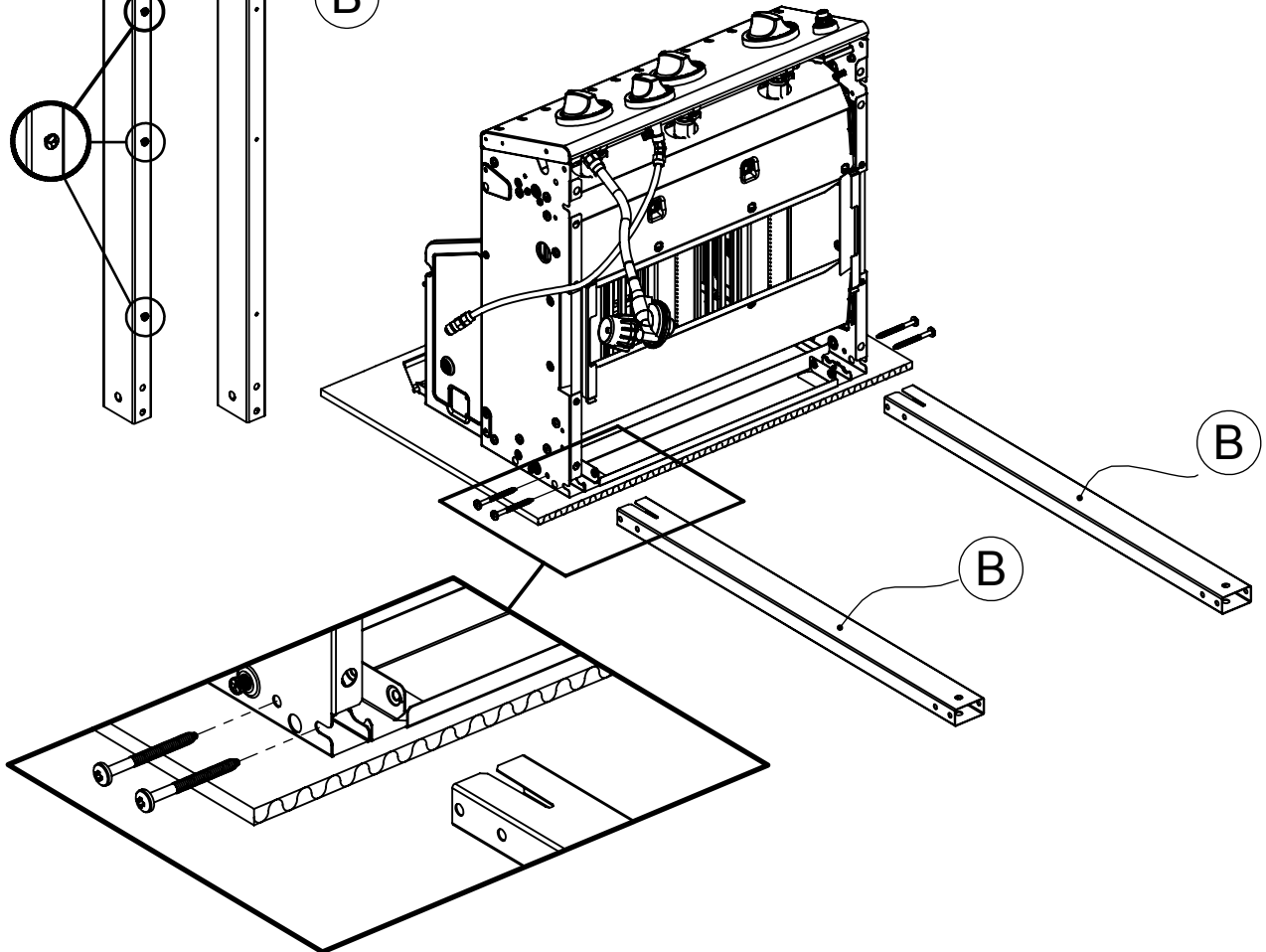
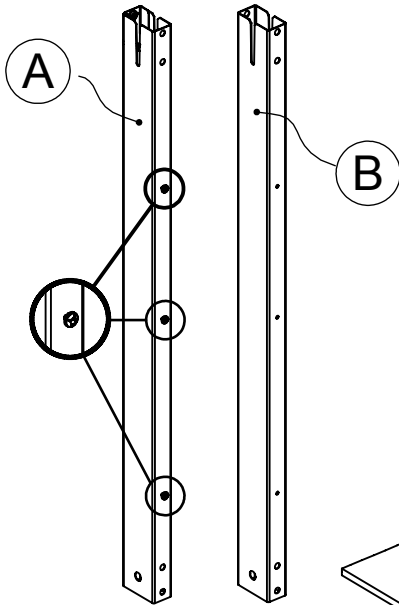

2

(2) 

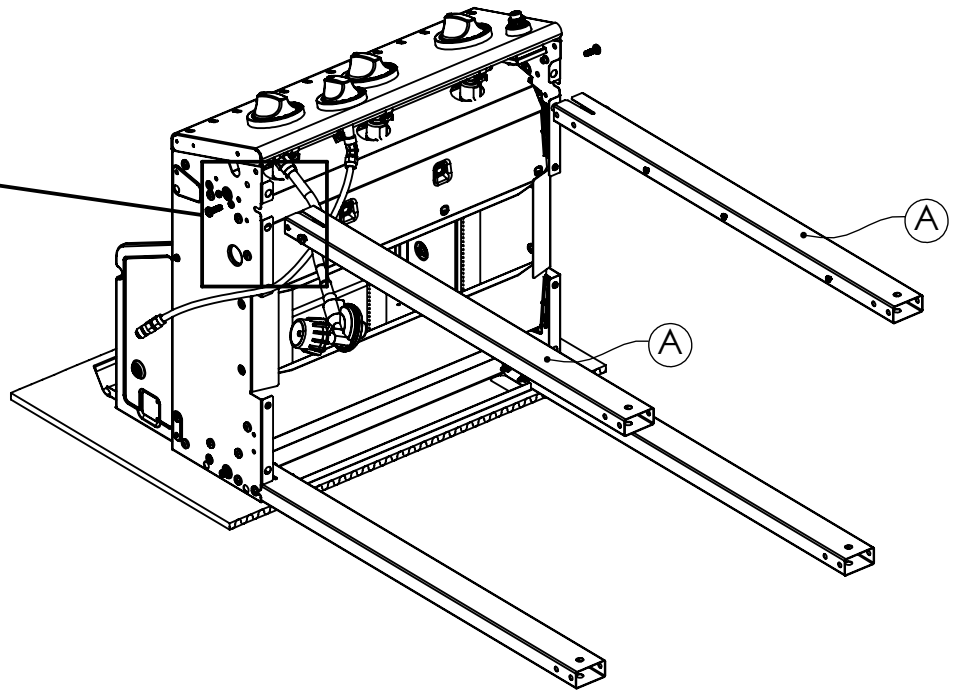
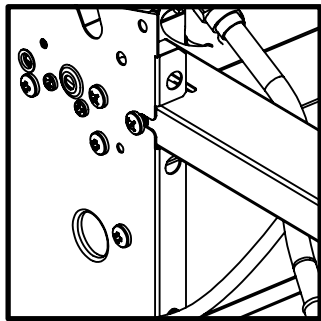
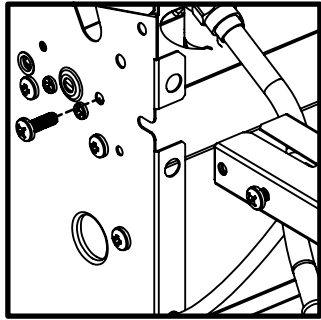

3

(8) 

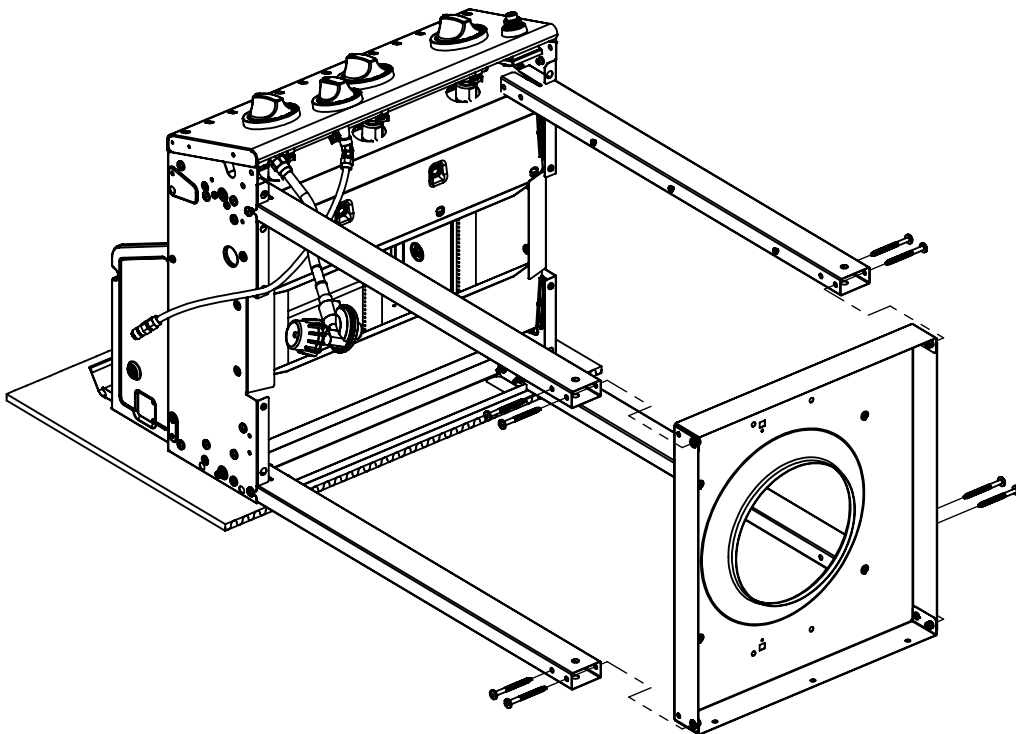

4

(2) 

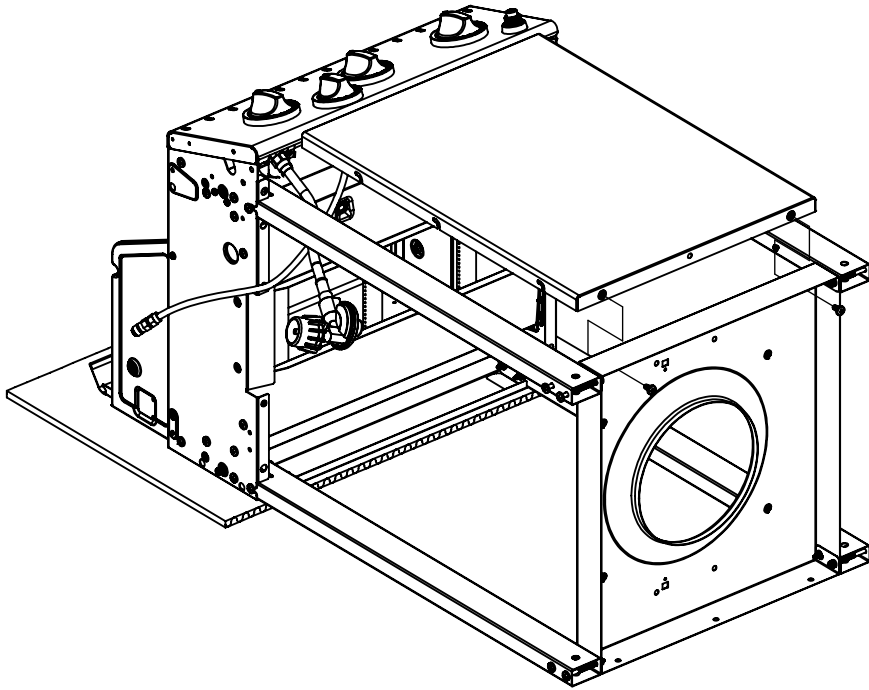

5

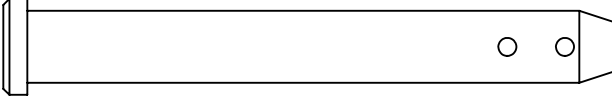
(2) 

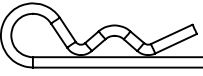
(2) 

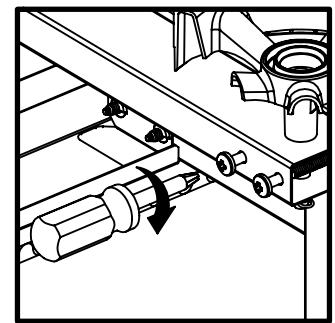

(x-8)

6

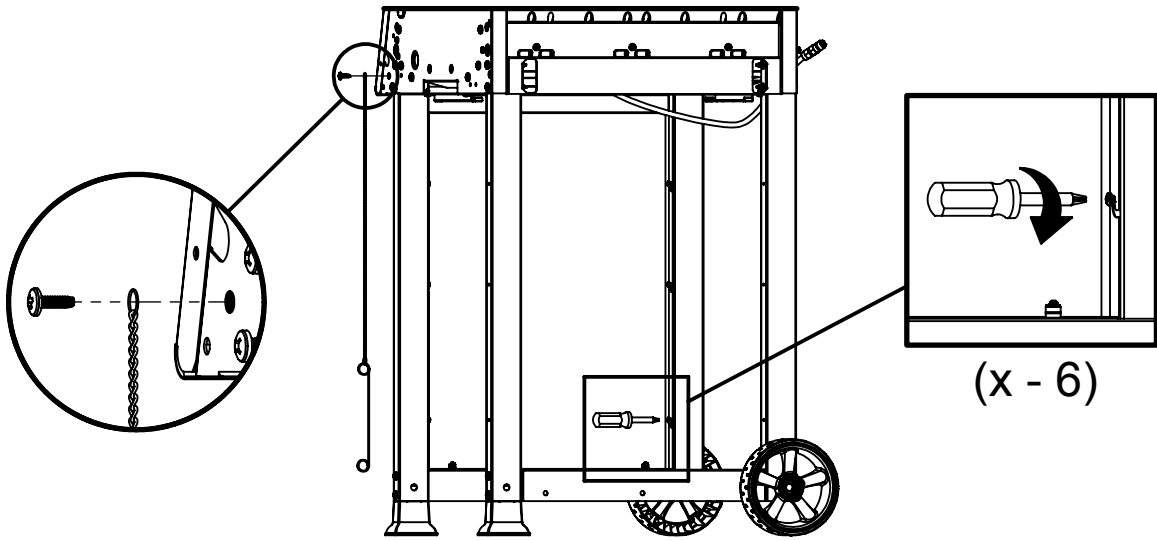
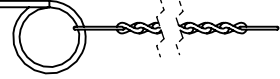
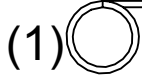
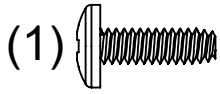

7

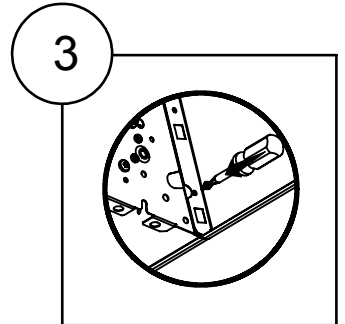
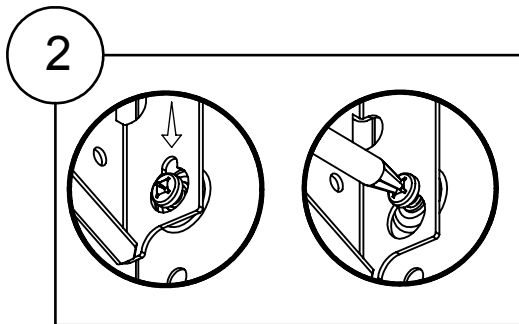
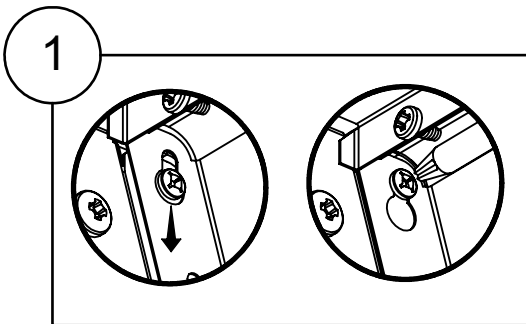
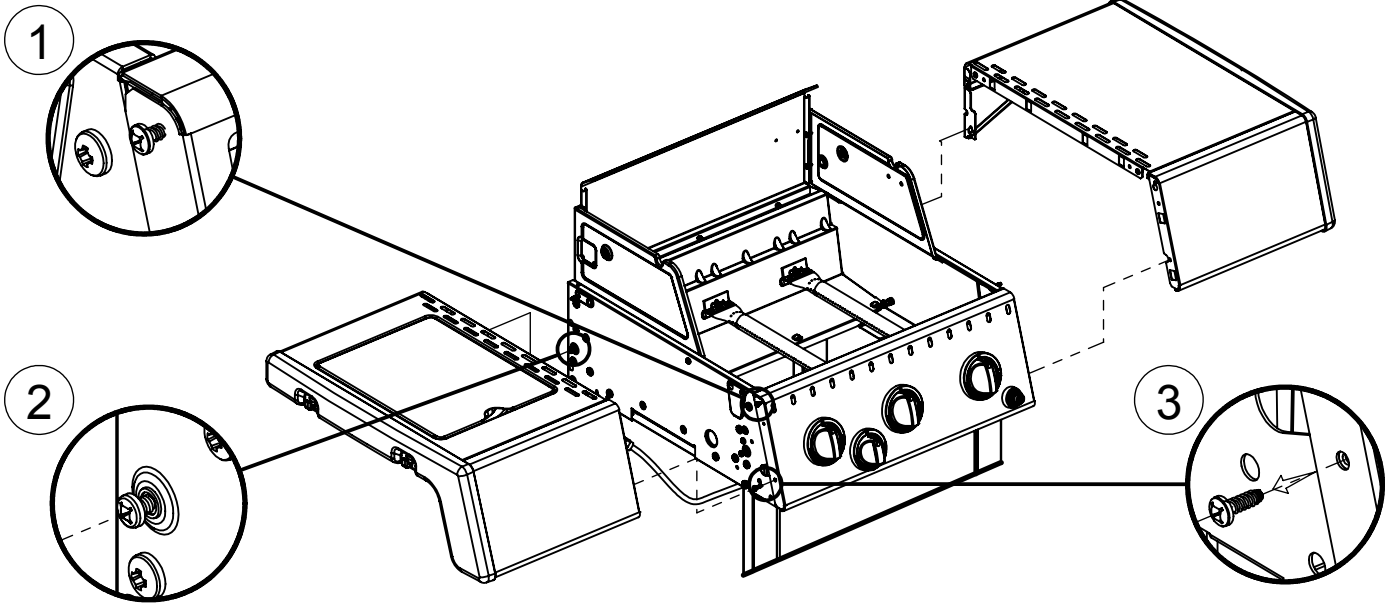

8

(4)

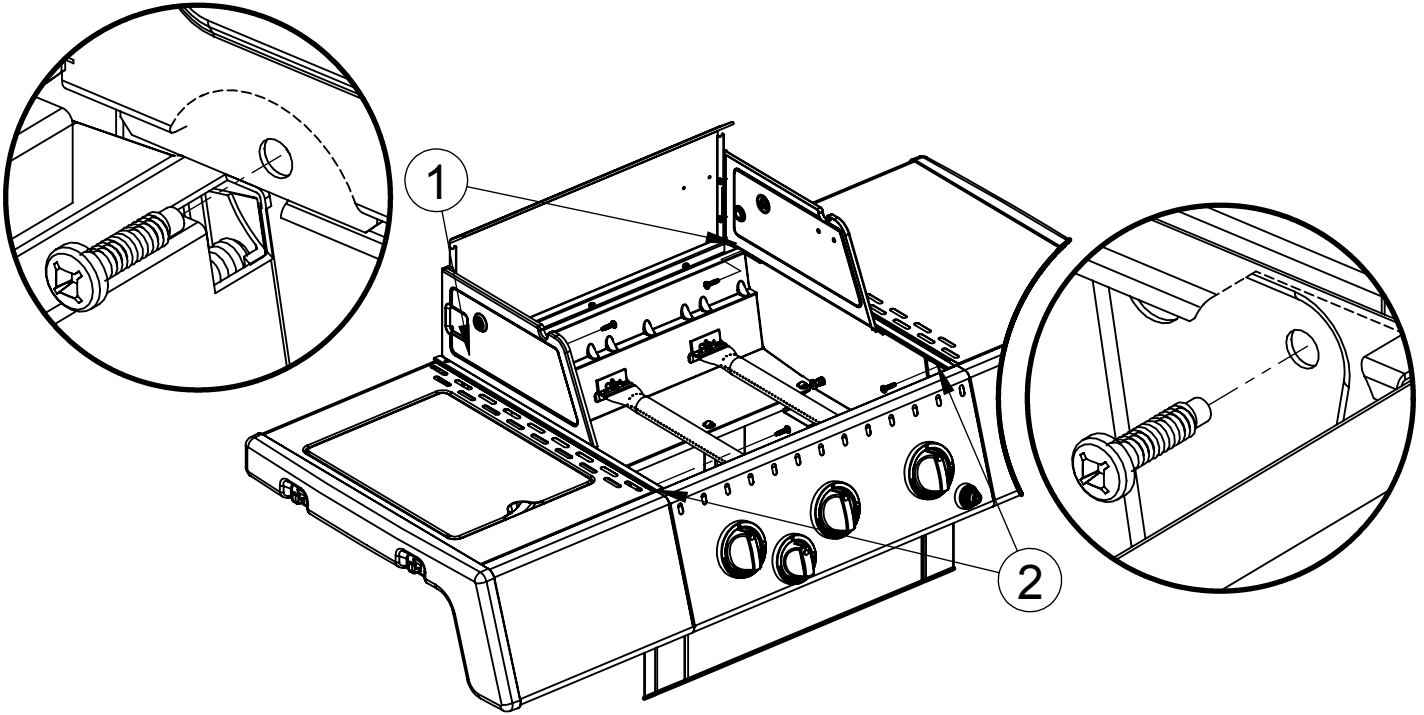

9

(1)

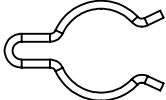

1

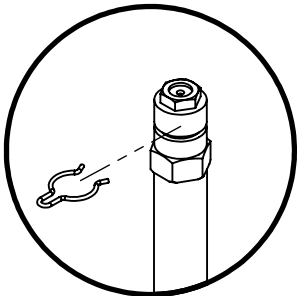

2

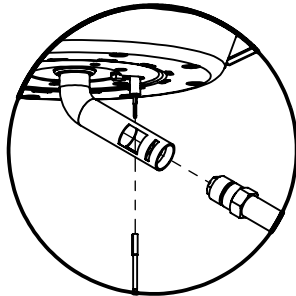

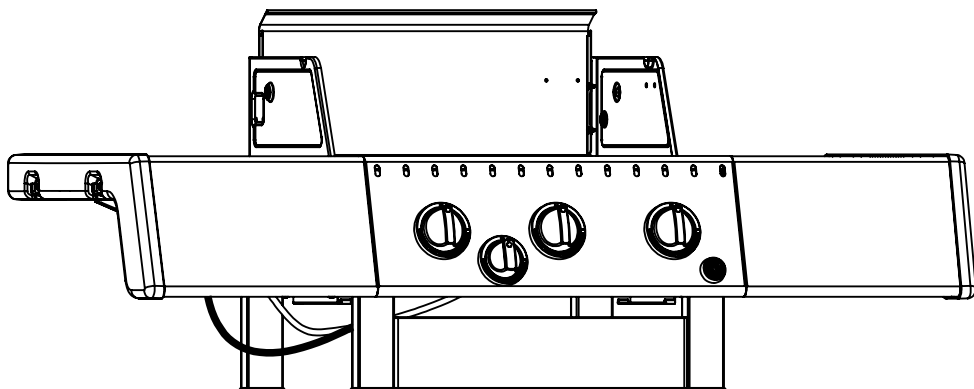
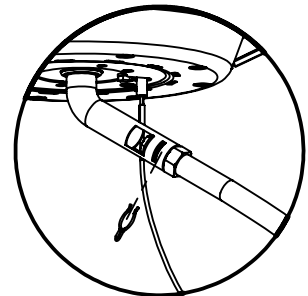

3



10

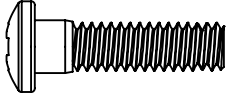
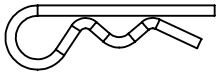

11

(2)  (2)  (2) 

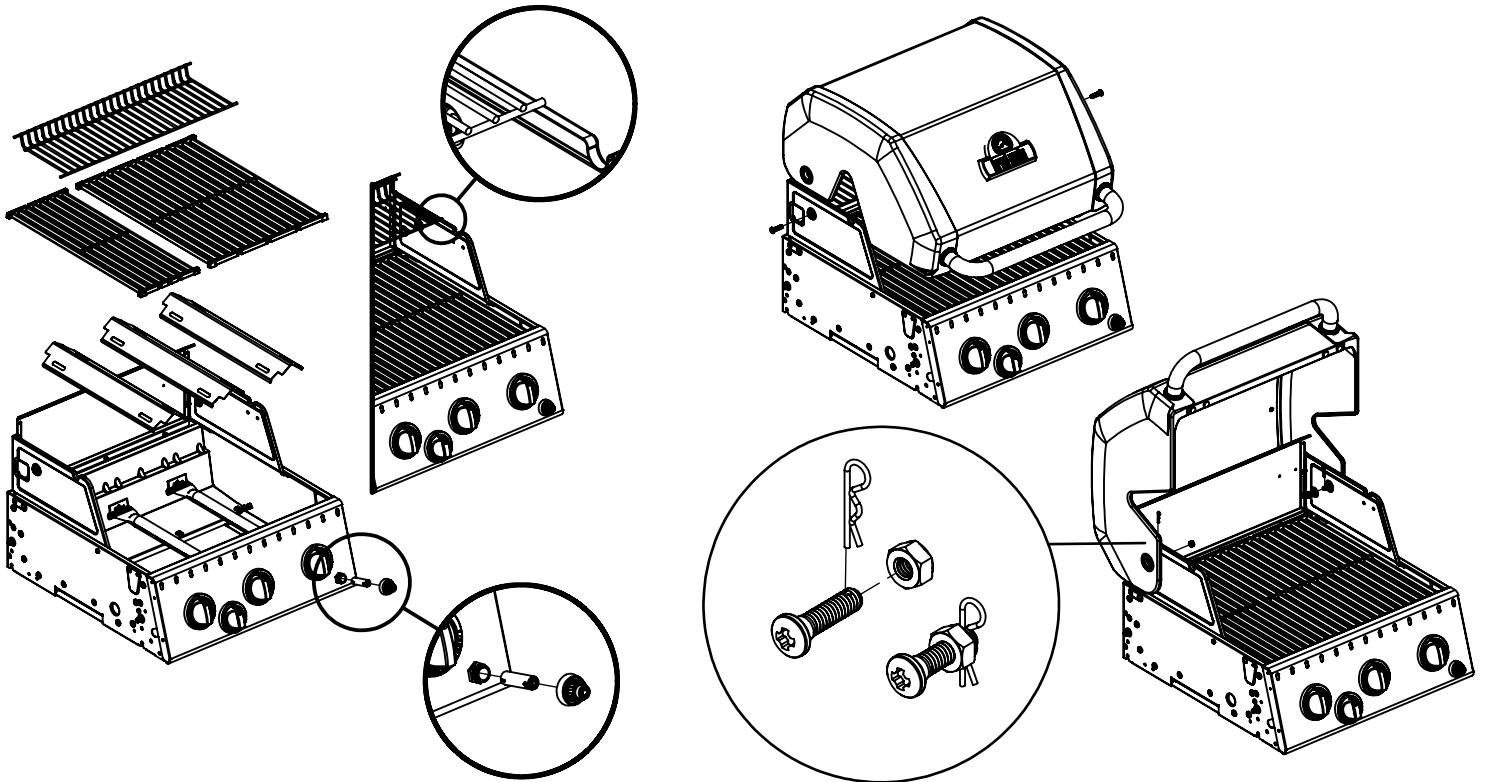

12

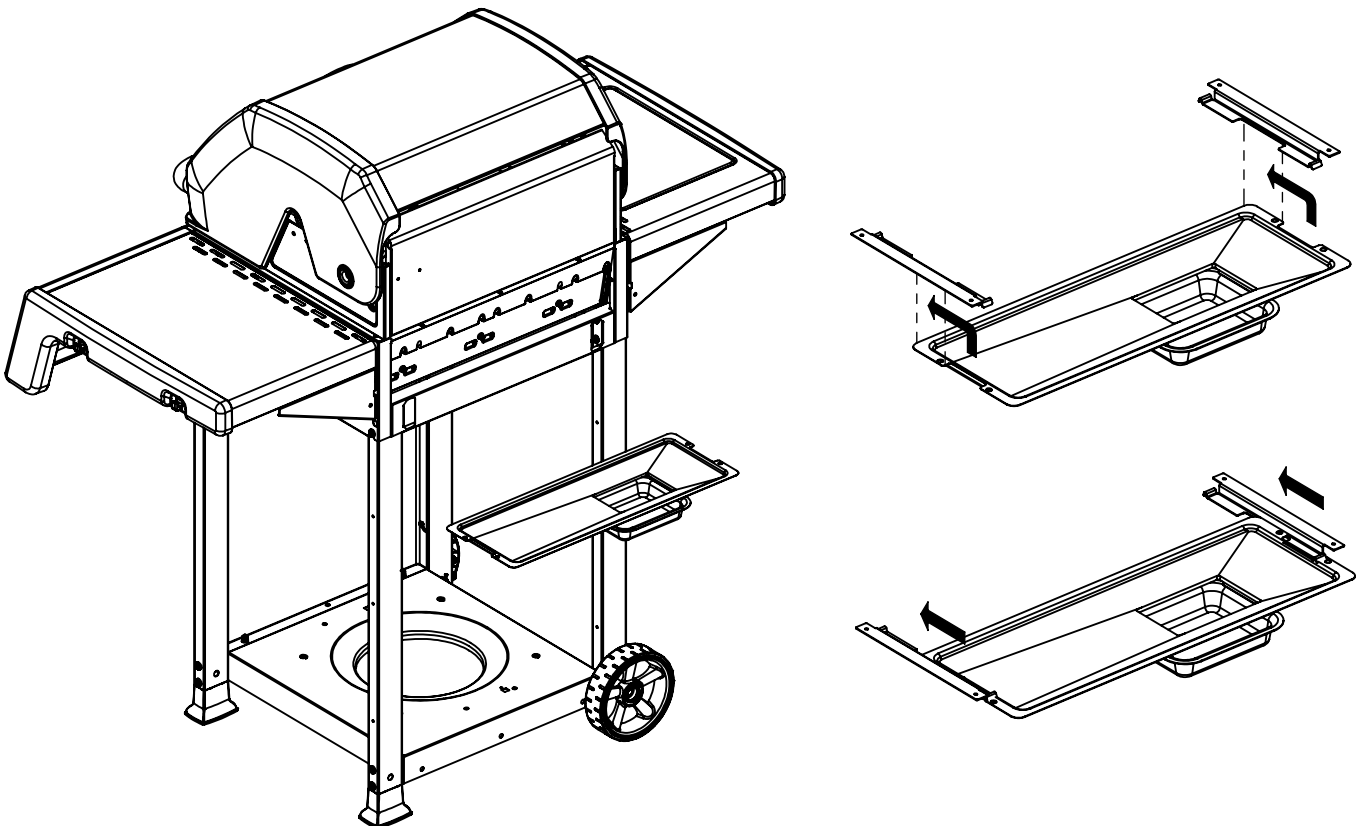

12

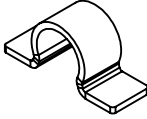
(2)  (2) 

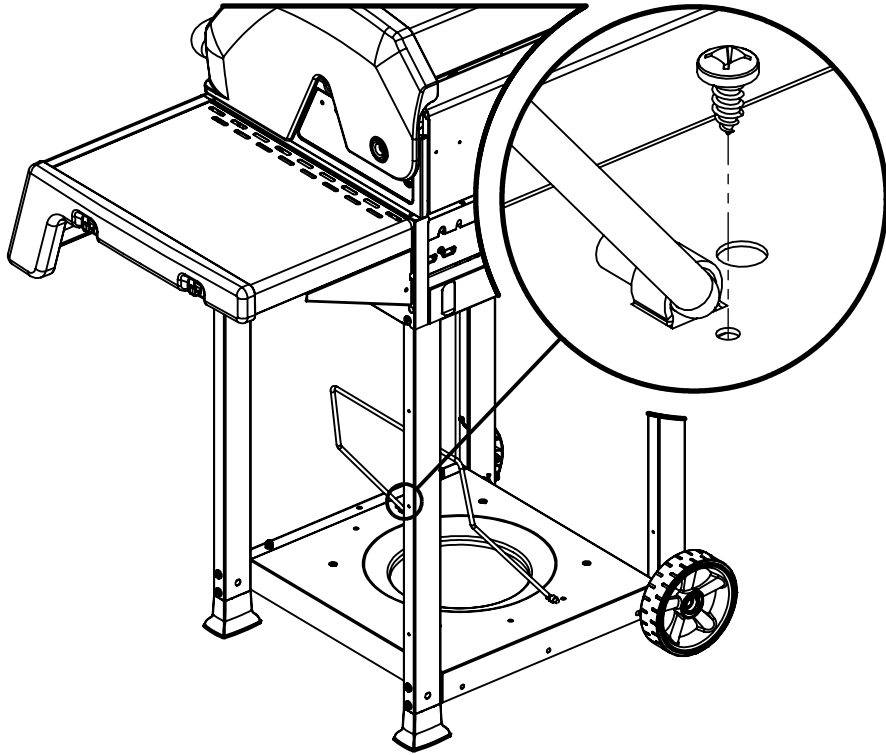

13

