

This Owner's Manual is provided and hosted by [Appliance Factory Parts](#).



# HUNTINGTON 681267B Owner's Manual

[Shop genuine replacement parts for HUNTINGTON  
681267B](#)



[Find Your HUNTINGTON Grill Parts - Select From 154 Models](#)

----- Manual continues below part list -----

## Available Replacement Parts for HUNTINGTON 681267B

<a href="#">S21233</a>	HITCH PIN CLIP +
<a href="#">Y-12860</a>	SCREW-THCP 1/4-20 X 1-TY-C A04
<a href="#">Y-11793</a>	NUT HEX 1/4 20 JS500 +
<a href="#">Y-12835</a>	SCREW-PHCP 6-32X1/4 TY-F JS500
<a href="#">Y-29307</a>	NUT HEX #10-24 JS500
<a href="#">10240-13</a>	WHEEL PIN
<a href="#">Y-11230</a>	HAIRPIN COTTER SIDE BURNER +
<a href="#">Y-11546</a>	SCREW PHCP 1/4-20X5/8 INCH A04#A
<a href="#">S21124</a>	SCREW PHCP #8 X 12 +
<a href="#">10390-E10</a>	BURNER SIDE 10BTU W/ELEC #8 +
<a href="#">Y-29304</a>	SCREW PHCP #10 24x3/8
<a href="#">S21125</a>	SCREW 8 X 3/8 PAN HEAD
<a href="#">S35094</a>	SCREW #10-24 X 5/8
<a href="#">10342-246</a>	IGNITOR ELECTRONIC TRIPLE +
<a href="#">Y-11231</a>	LID BUMPER ROUND BLK
<a href="#">10342-E13</a>	ELECTRODE W/WIRE
<a href="#">10342-T18</a>	WIRE ELECTRODE S/B 600 +
<a href="#">18431</a>	FLAV-R-WAVE - BARON - SS
<a href="#">52007-181</a>	COOKING GRID 550 PORC BLK +
<a href="#">10240-23</a>	LID PIN 1/4-20
<a href="#">Y-29310</a>	SCREW #10-24 3/4 TRUSS QU
<a href="#">20005-000</a>	HARDWARE BAG STICK & CHAIN SS
<a href="#">80012</a>	regulator and hose READ ADD. INFO
<a href="#">10342-245</a>	IGNITOR ELECTRONIC DUAL +
<a href="#">10892-608</a>	WHEEL 6 INCH
<a href="#">22049-102</a>	GREASE TRAY BRACKET GAL 330/440/550
<a href="#">24004-12A</a>	LID HANDLE BENT 330 430SS
<a href="#">51429-158</a>	RESIN FOOT 330/440
<a href="#">53184-118</a>	SHELF END CAP RHS 330/440
<a href="#">53184-138</a>	SHELF END CAP LHS 330/440

<a href="#">53404-114</a>	SHELF FRONT FACIA RHS 330/440
<a href="#">57154-901</a>	GREASE TRY 340/401 0.8MM BLK HI HEAT PNT
<a href="#">59004-014</a>	VALVE ASSY 330 3V LP
<a href="#">59004-017</a>	VALVE ASSEMBLY 3V NG
<a href="#">59004-034</a>	VALVE ASSEMBLY 3V+SB LP
<a href="#">59004-037</a>	VALVE ASSEMBLY 3V+SB NG
<a href="#">53009-951</a>	SIDE BURNER TRIVET BLK
<a href="#">Y-11235</a>	LID BUMPER HEX-BLK AB
<a href="#">Y-12865</a>	SCREW 1/4 X 20X1/2 TYPE-C PHCP
<a href="#">18010</a>	LID HEAT INDICATOR - SMALL - SS
<a href="#">52004-091</a>	WARMING RACK PORC BLK 330
<a href="#">52249-404</a>	HEAT TENT SS
<a href="#">53104-111</a>	SHELF RHS BLK 330/440
<a href="#">S21242</a>	CLIP BURNER TUBE MOUNT SS
<a href="#">52924-144R</a>	BURNER - MAIN
<a href="#">Y-11544S</a>	SCREW - BURNER #10-24 X 3/8
<a href="#">10111-K45</a>	HOSE 3/8 INCH ASSEMBLY NG 10 FOOT +
<a href="#">24009-936</a>	HANDLE RING
<a href="#">10472-K431</a>	CONTRL KNOB RESIN LRG BLCK W/SS BA STRIP
<a href="#">22001-168</a>	CONTROL KNOB BEZEL SML
<a href="#">22002-268</a>	CONTROL KNOB BEZEL LARGE
<a href="#">52009-901</a>	GREASE PAN - BLACK HIGH HEAT PAINT
<a href="#">52904-144NG</a>	BURNER ASSY MAIN SINGLE TUBE + NG
<a href="#">27249-904</a>	GREASE SHIELD MODULAR, 6.5 x 6

# OMC

ASSEMBLY MANUAL & PARTS LIST • MANUEL DE MONTAGE & LISTE DE PIÈCES • MANUAL DE ARMADO Y LISTA DE PARTES



**STERLING** 6

581264B  
581267B

HUNTINGTON™

681264B  
681267B

**broil-mate**™

781264B  
781267B



**STERLING** 6

581264  
581267

HUNTINGTON™

681264  
681267

**broil-mate**™

781264  
781267



**STERLING** 6

581254B  
581257B

HUNTINGTON™

681254B  
681257B

**broil-mate**™

781254B  
781257B



**STERLING** 6

581254  
581257

HUNTINGTON™

681254  
681257

**broil-mate**™

781254  
781257

RETAIN FOR FUTURE REFERENCE • VEUILLEZ CONSERVER POUR REFERENCE ULTERIEURE • CONSERVAR PARA FUTURAS CONSULTAS

1-800-265-2150

[info@omcbbq.com](mailto:info@omcbbq.com)

*Onward*  
MANUFACTURING COMPANY

SINCE 1906

1000 EAST MARKET STREET  
HUNTINGTON, INDIANA, 46750, USA

50084-C34 Rev B 10/15

1

(4)

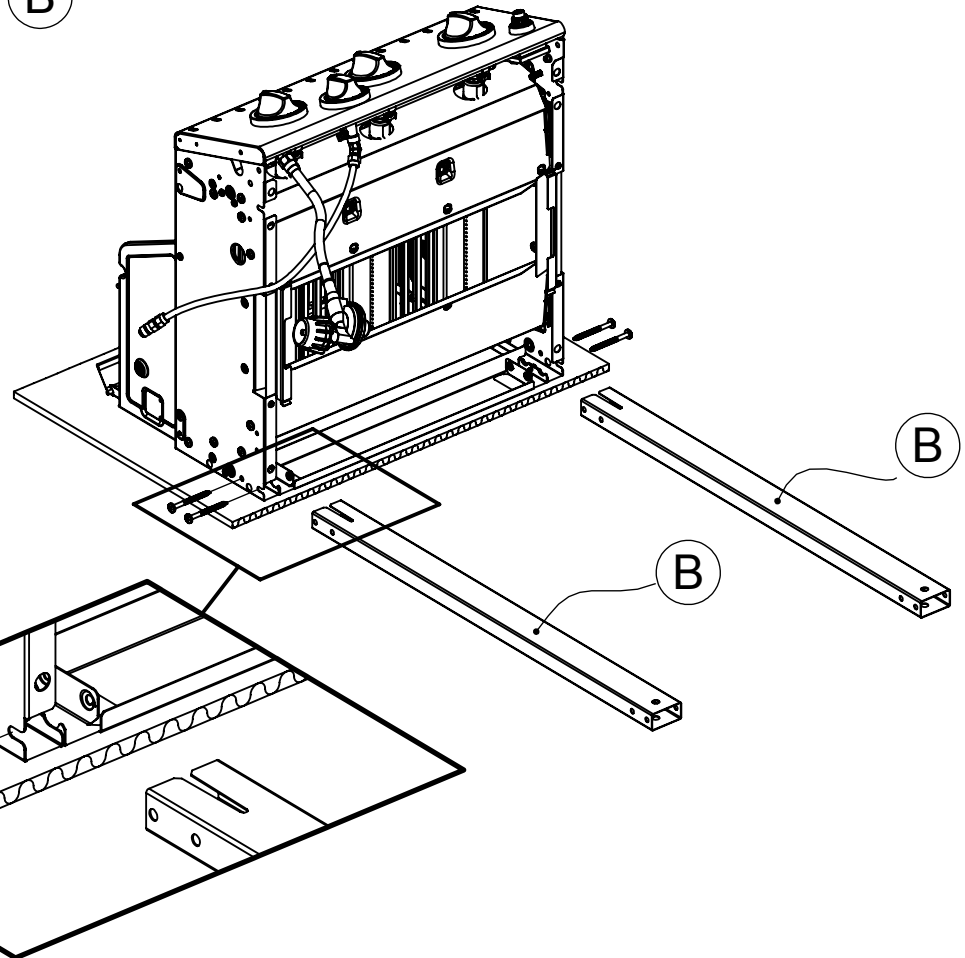
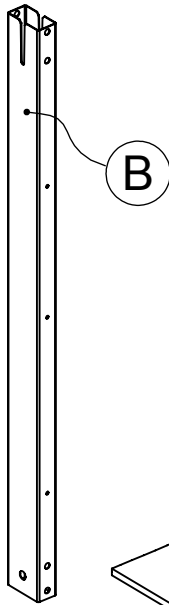
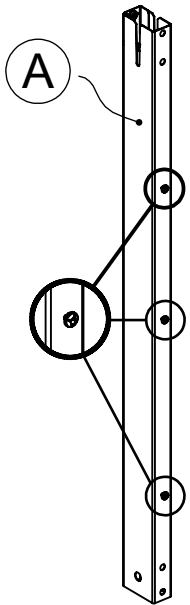

**2**

(2) 

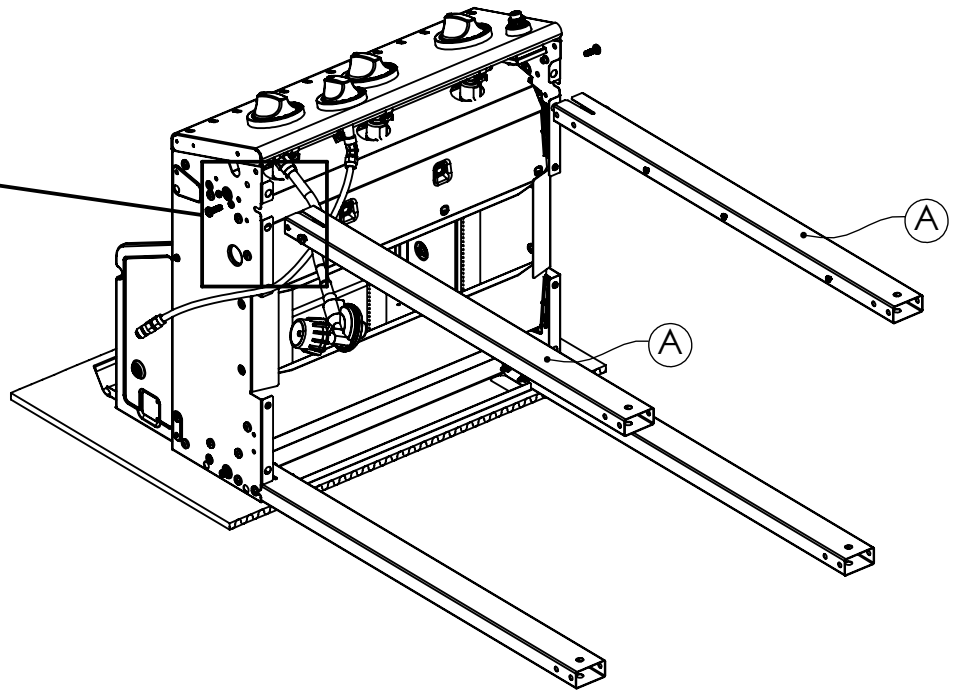
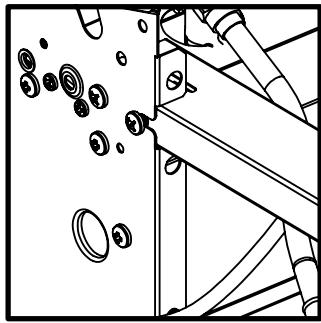
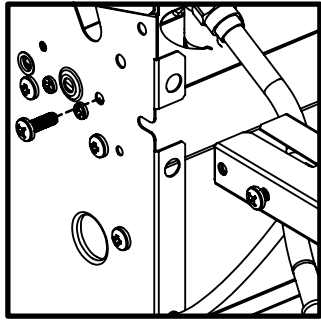

**3**

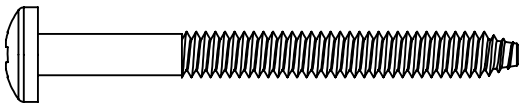
(8) 

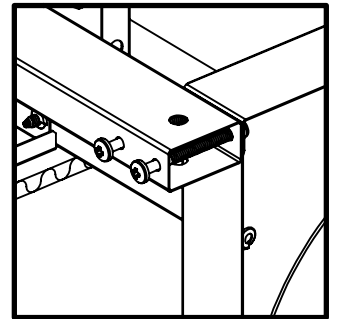
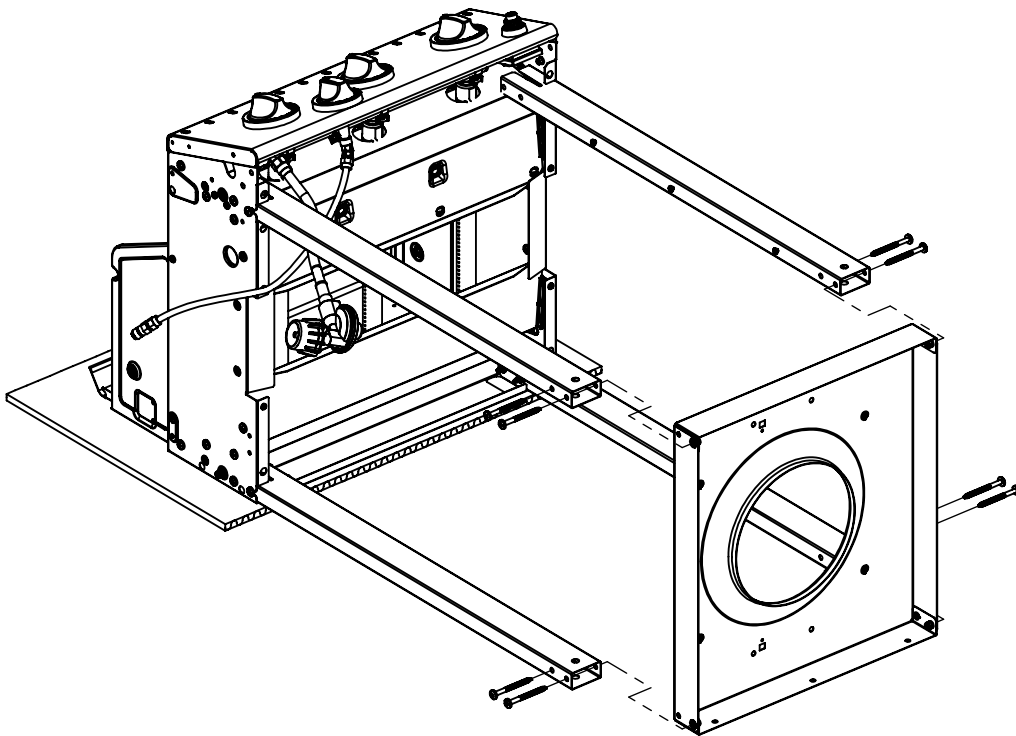

4

(2) 

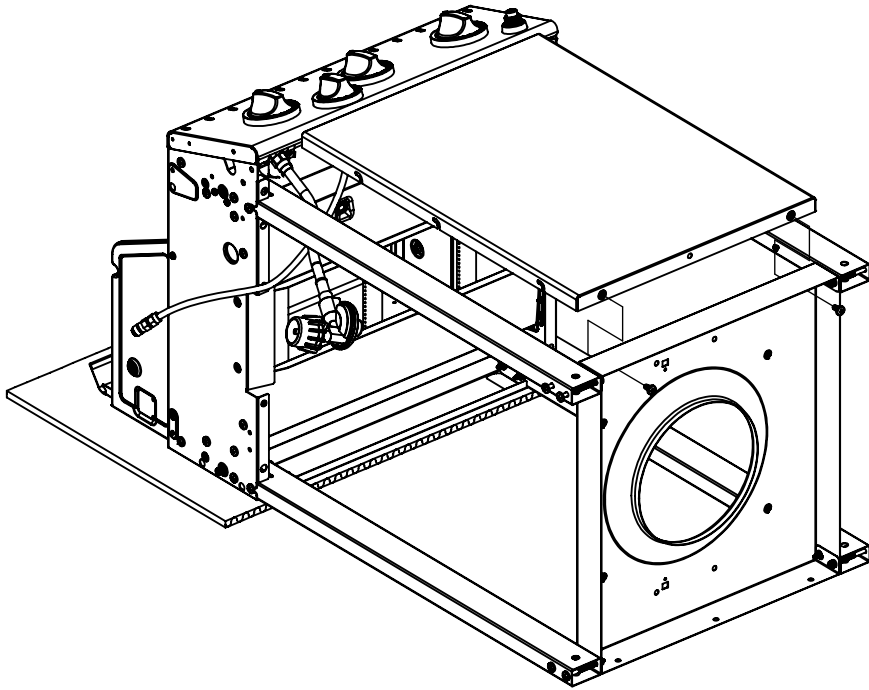

5

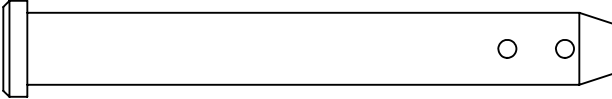
(2) 

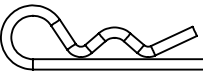
(2) 

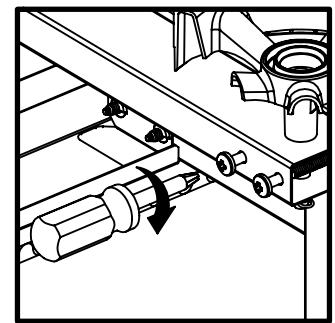

(x-8)

6

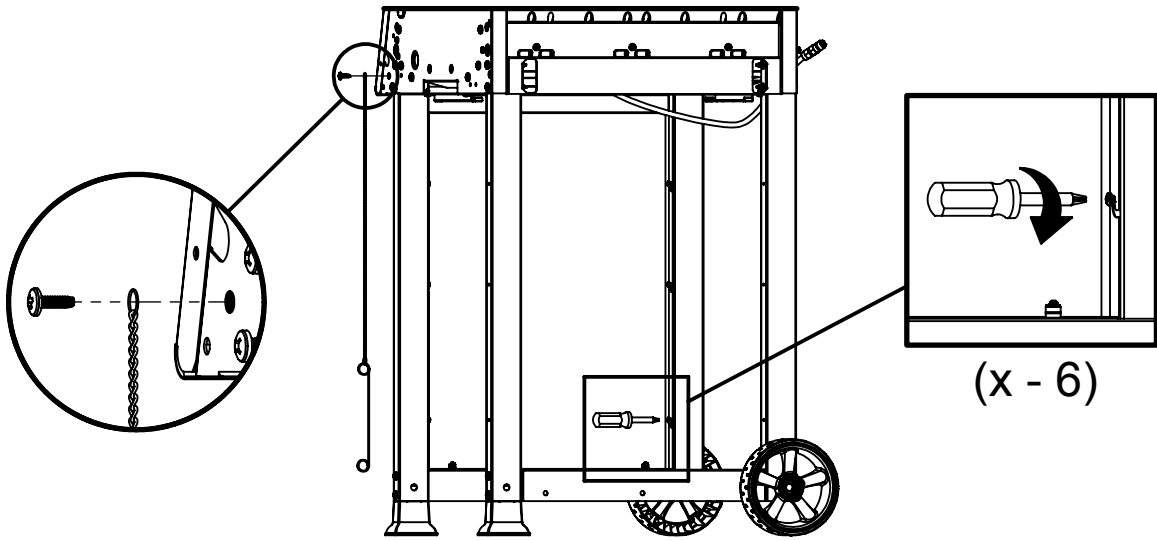
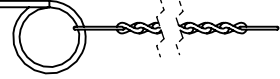
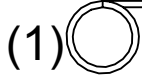
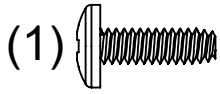

7

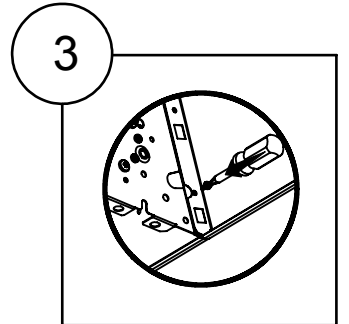
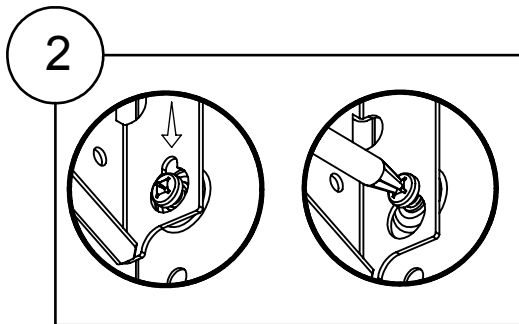
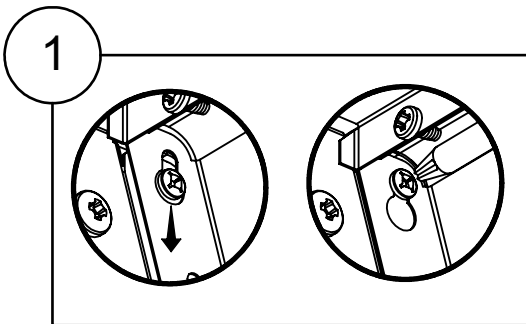
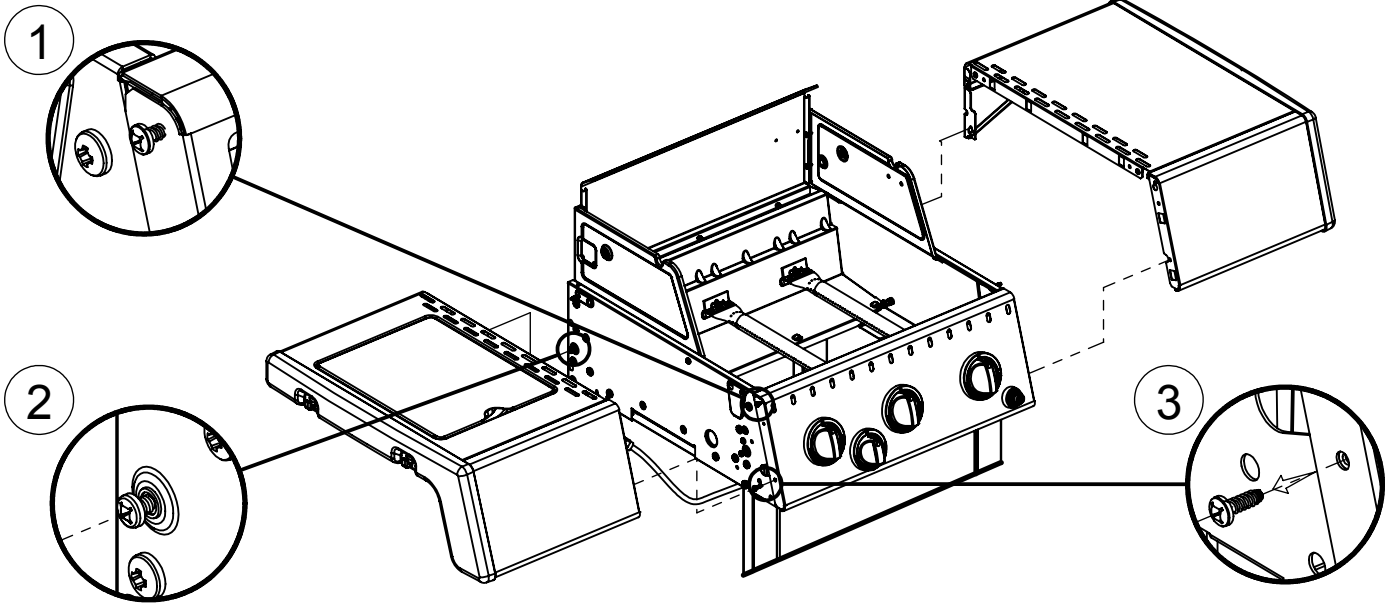

8

(4)

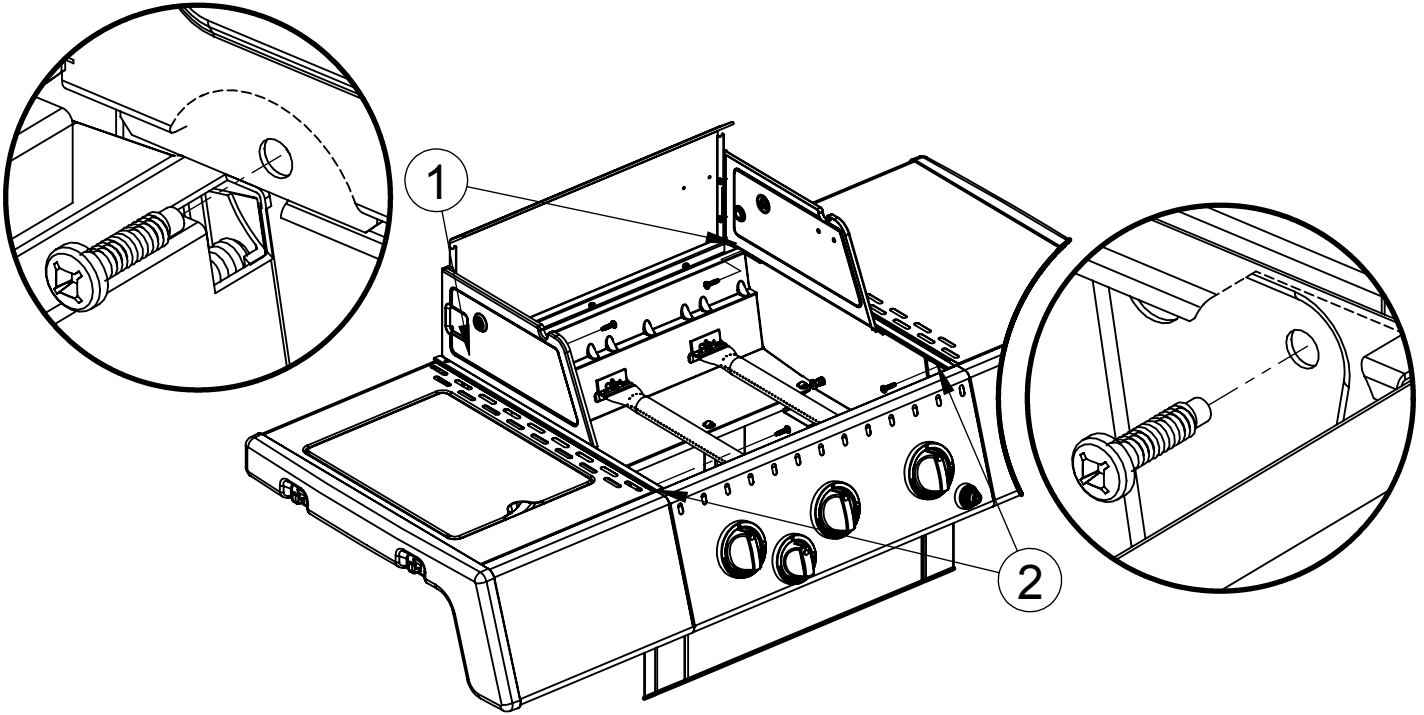
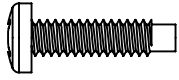

9

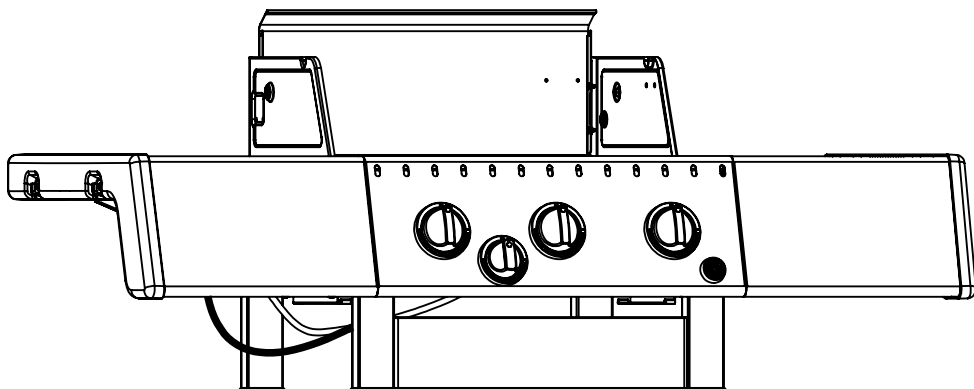
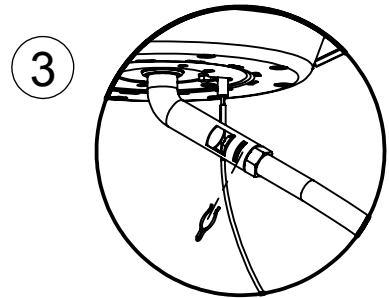
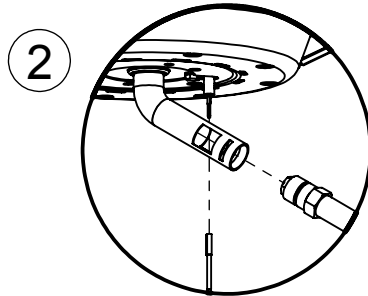
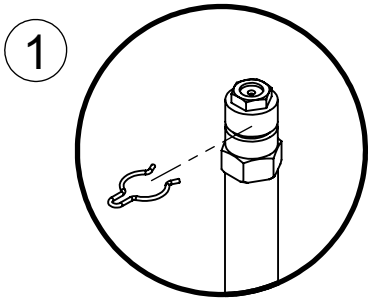
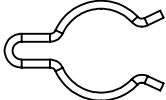

(1)



10

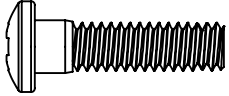
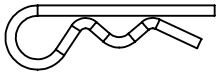

11

(2)  (2)  (2) 

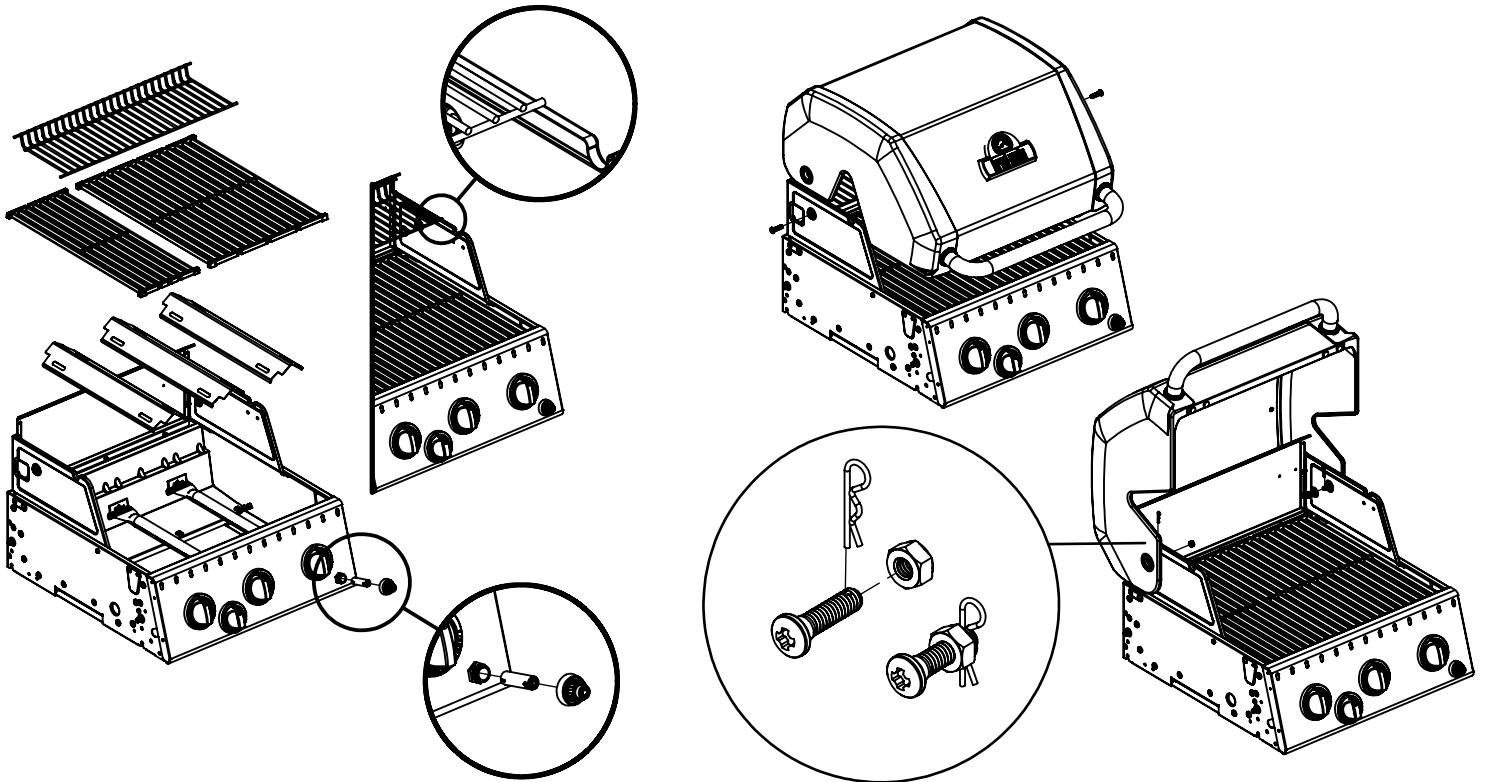

12

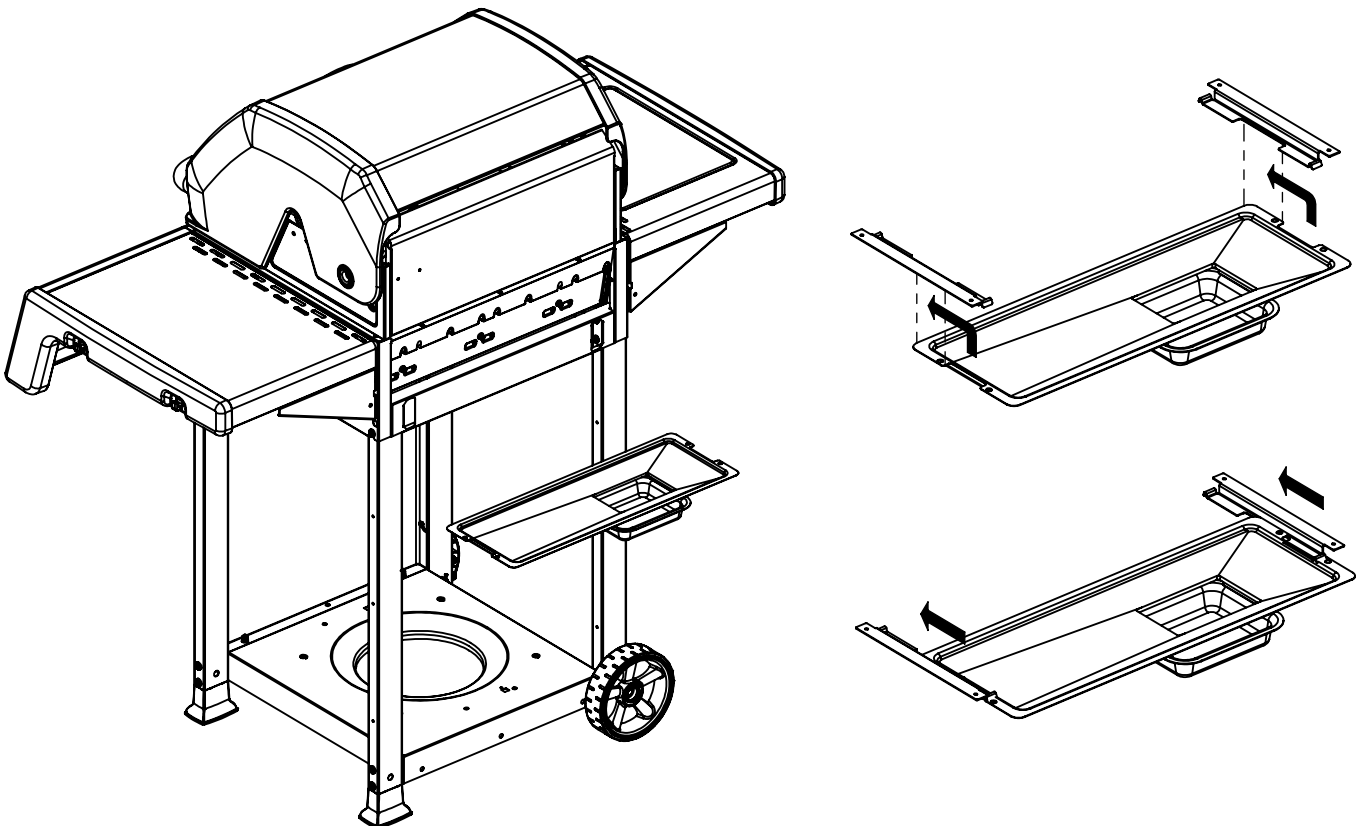

12

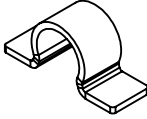
(2)  (2) 

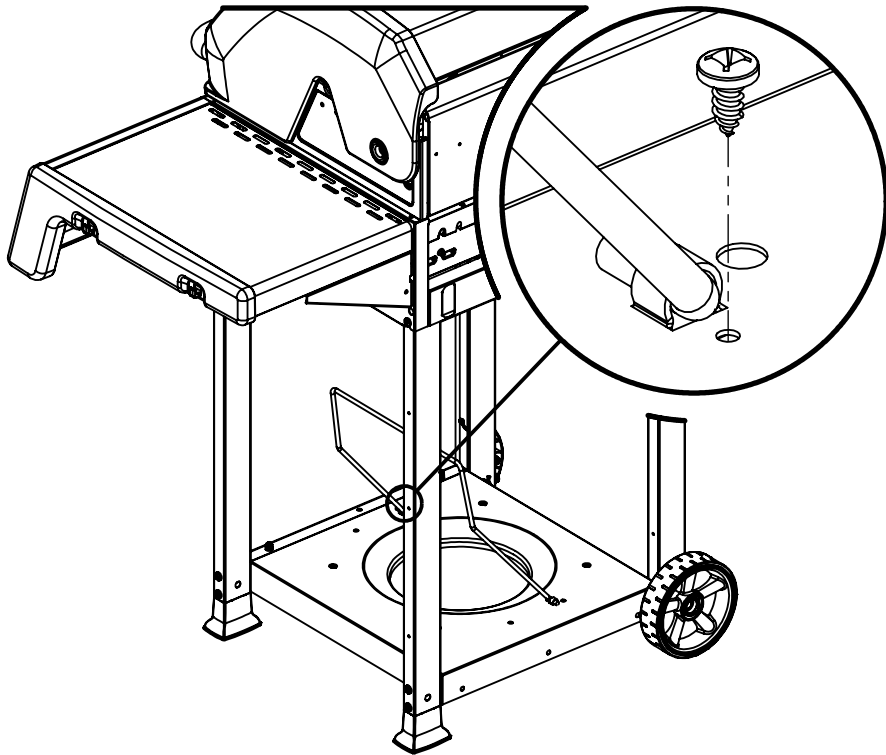

13

