

This Owner's Manual is provided and hosted by [Appliance Factory Parts](#).



Sterling 5132-64 Owner's Manual

[Shop genuine replacement parts for Sterling 5132-64](#)



[Find Your Sterling Grill Parts - Select From 509 Models](#)

----- Manual continues below part list -----

Available Replacement Parts for Sterling 5132-64

18013	LID HEAT INDICATOR - LARGE - SS
S21233	HITCH PIN CLIP +
Y-12860	SCREW-THCP 1/4-20 X 1-TY-C A04
Y-11793	NUT HEX 1/4 20 JS500 +
Y-12835	SCREW-PHCP 6-32X1/4 TY-F JS500
Y-29307	NUT HEX #10-24 JS500
10240-13	WHEEL PIN
Y-11230	HAIRPIN COTTER SIDE BURNER +
Y-11546	SCREW PHCP 1/4-20X5/8 INCH A04#A
S21124	SCREW PHCP #8 X 12 +
10390-E10	BURNER SIDE 10BTU W/ELEC #8 +
Y-29304	SCREW PHCP #10 24x3/8
S21125	SCREW 8 X 3/8 PAN HEAD
S35094	SCREW #10-24 X 5/8
10342-246	IGNITOR ELECTRONIC TRIPLE +
Y-11231	LID BUMPER ROUND BLK
10342-E13	ELECTRODE W/WIRE
10342-T18	WIRE ELECTRODE S/B 600 +
24006-12A	HANDLE LID ASSY 625
52007-181	COOKING GRID 550 PORC BLK +
10240-23	LID PIN 1/4-20
Y-29310	SCREW #10-24 3/4 TRUSS QU
52316-151	FIREBOX 550 HOOD PANEL PORC
59006-034	CONTROL ASSY 5V S/B LP
59006-037	CONTROL ASSY 5V S/B NG
52006-991	WARMING RACK 550 PORC +
20005-000	HARDWARE BAG STICK & CHAIN SS
44089-60	NAMEPLATE PATRIOT
52016-903	COLLECTOR BOX ASSEMBLY 625
80012	regulator and hose READ ADD. INFO

10892-608	WHEEL 6 INCH
22049-102	GREASE TRAY BRACKET GAL 330/440/550
51429-158	RESIN FOOT 330/440
53184-118	SHELF END CAP RHS 330/440
53184-138	SHELF END CAP LHS 330/440
53404-114	SHELF FRONT FACIA RHS 330/440
53009-951	SIDE BURNER TRIVET BLK
Y-11235	LID BUMPER HEX-BLK AB
Y-12865	SCREW 1/4 X 20X1/2 TYPE-C PHCP
52249-404	HEAT TENT SS
53104-111	SHELF RHS BLK 330/440
59006-014	CONTROL ASSY 550 5V LP
59006-017	VALVE ASSY 550 5V MAIN NG
S21242	CLIP BURNER TUBE MOUNT SS
52924-144R	BURNER - MAIN
57056-901	GREASE TRAY BLK
Y-11544S	SCREW - BURNER #10-24 X 3/8
10111-K45	HOSE 3/8 INCH ASSEMBLY NG 10 FOOT +
10081-69BM	NAMEPLATE BROILMATE
24009-936	HANDLE RING
10342-247	IGNITOR ELECTRONIC +
10472-K431	CONTRL KNOB RESIN LRG BLCK W/SS BA STRIP
22001-168	CONTROL KNOB BEZEL SML
22002-268	CONTROL KNOB BEZEL LARGE
52009-901	GREASE PAN - BLACK HIGH HEAT PAINT
52904-144NG	BURNER ASSY MAIN SINGLE TUBE + NG
27249-904	GREASE SHIELD MODULAR, 6.5 x 6



REDDI-BUILT BABEQUES

ASSEMBLY MANUAL & PARTS LIST • MANUEL DE MONTAGE & LISTE DE PIECES • MANUAL DE ARMADO Y LISTA DE PARTES



broil-mate™
ONE TOUGH GRILL
7132-64/67

STERLING®
5132-64/67
5132-54/57

RETAIN FOR FUTURE REFERENCE • VEUILLEZ CONSERVER POUR REFERENCE ULTERIEURE • CONSERVAR PARA FUTURAS CONSULTAS

1-800-265-2150

info@omcbbq.com

Onward
SINCE 1906
MANUFACTURING COMPANY
1000 EAST MARKET STREET
HUNTINGTON, INDIANA, 46750, USA

50084-C90 Rev A 11/13

1

(4)

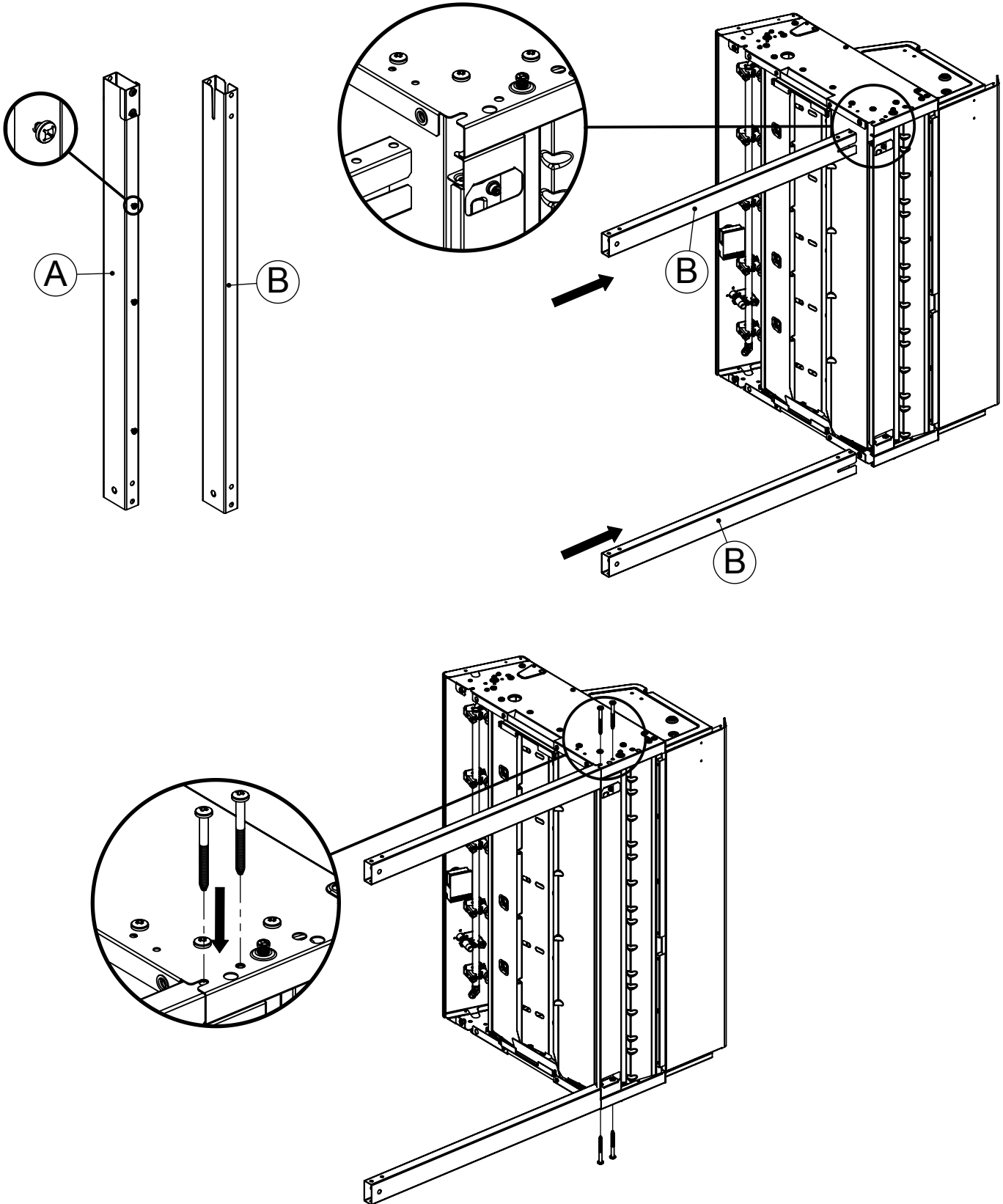
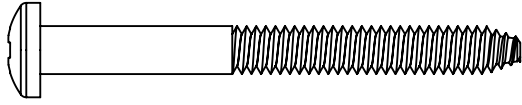

2

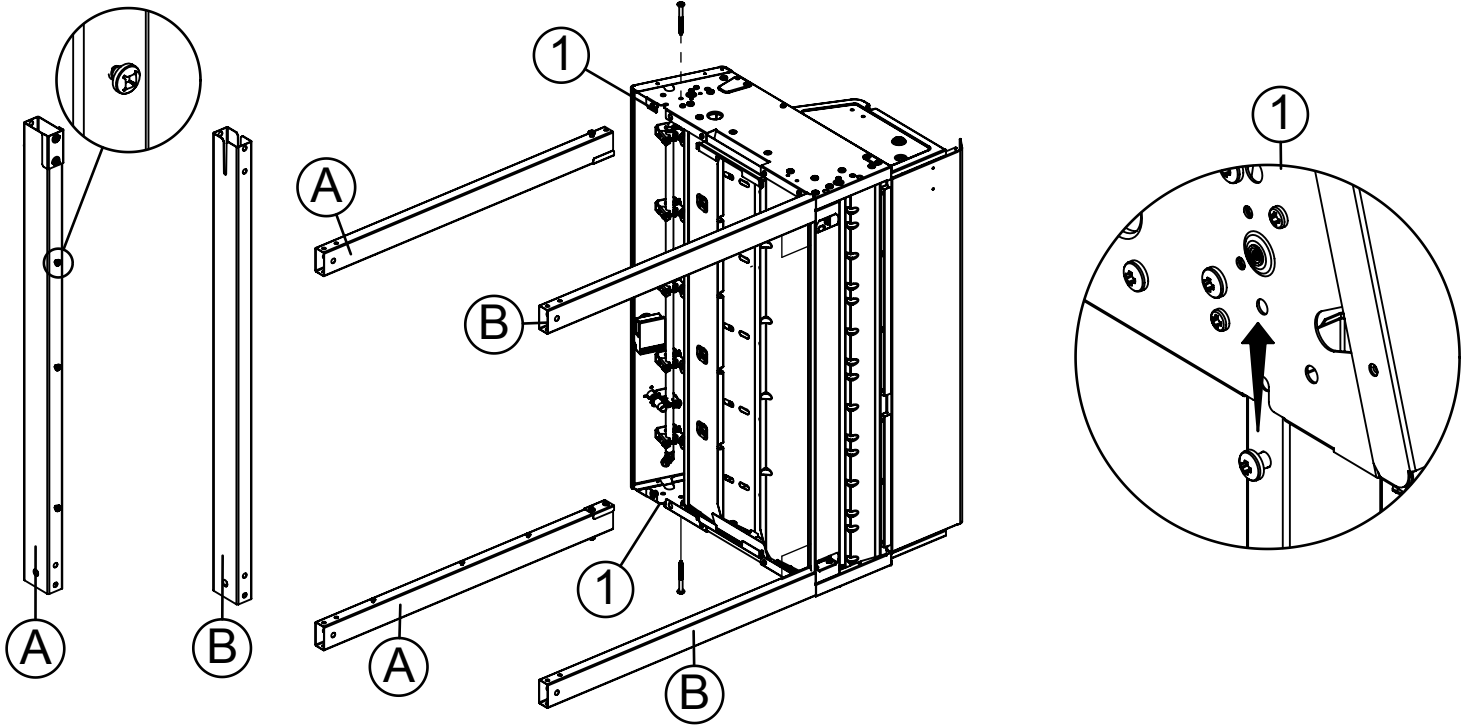
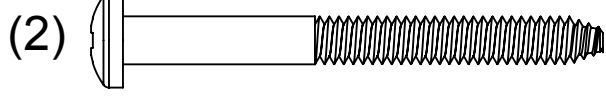

3

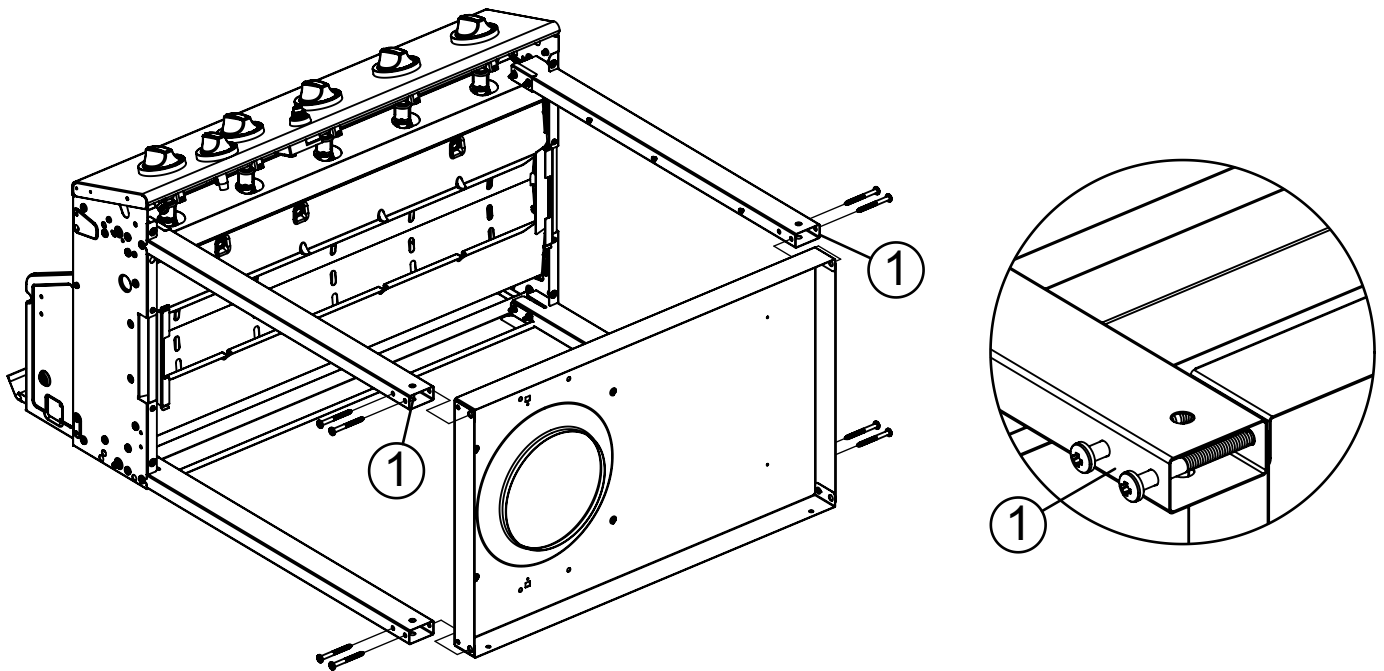
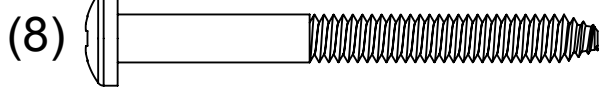

4

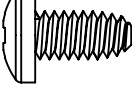
(2) 

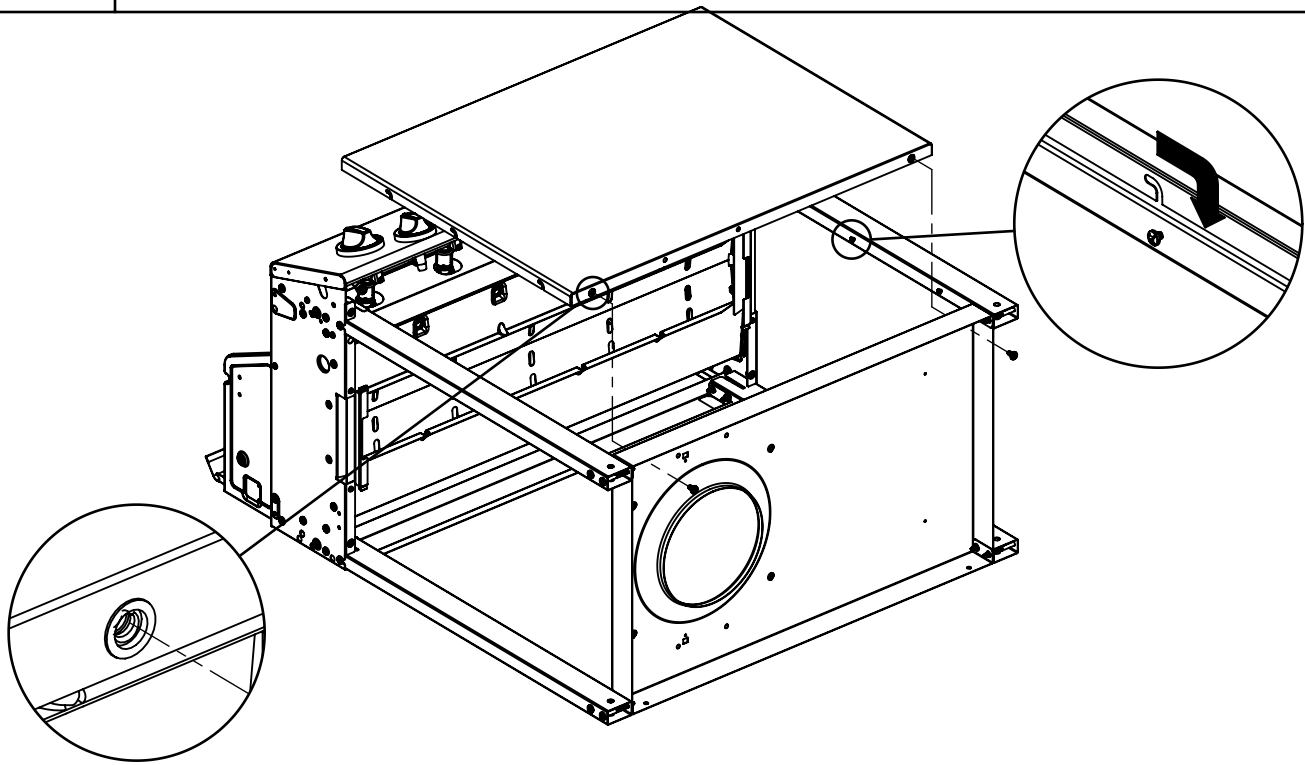

5

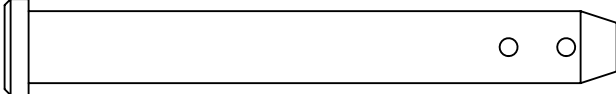
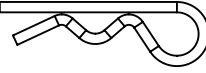
(2)  (2) 

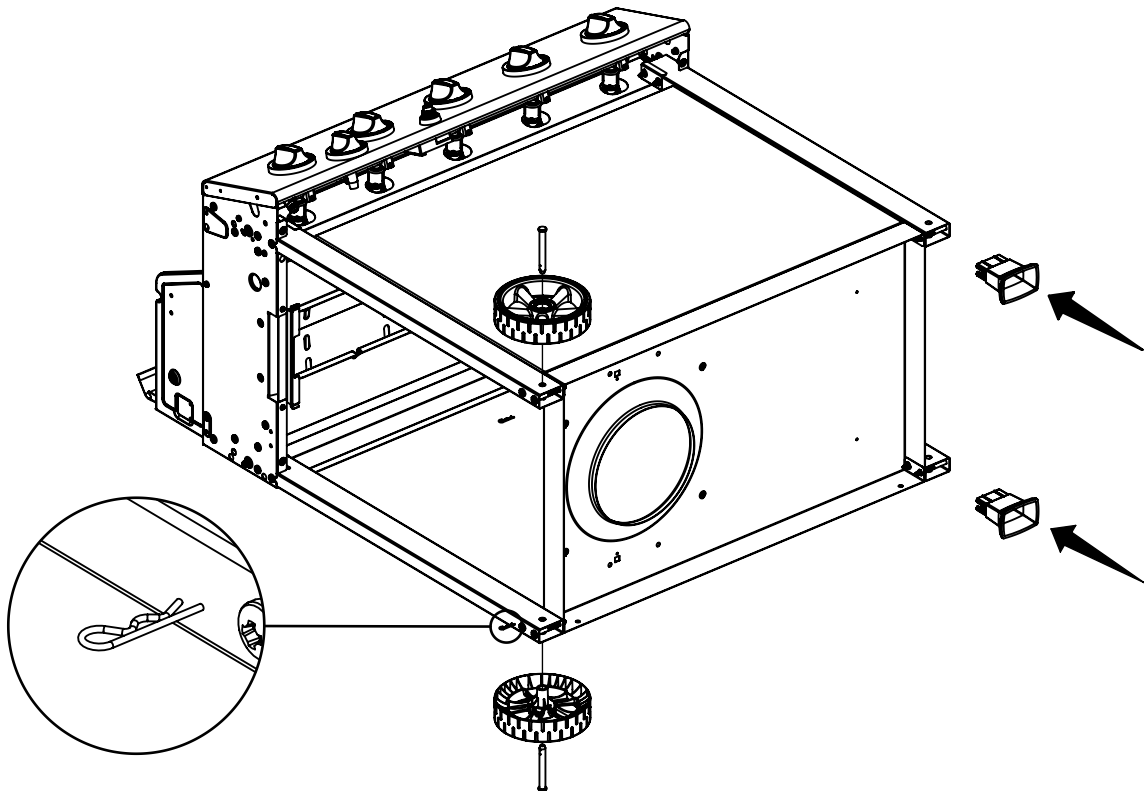

6

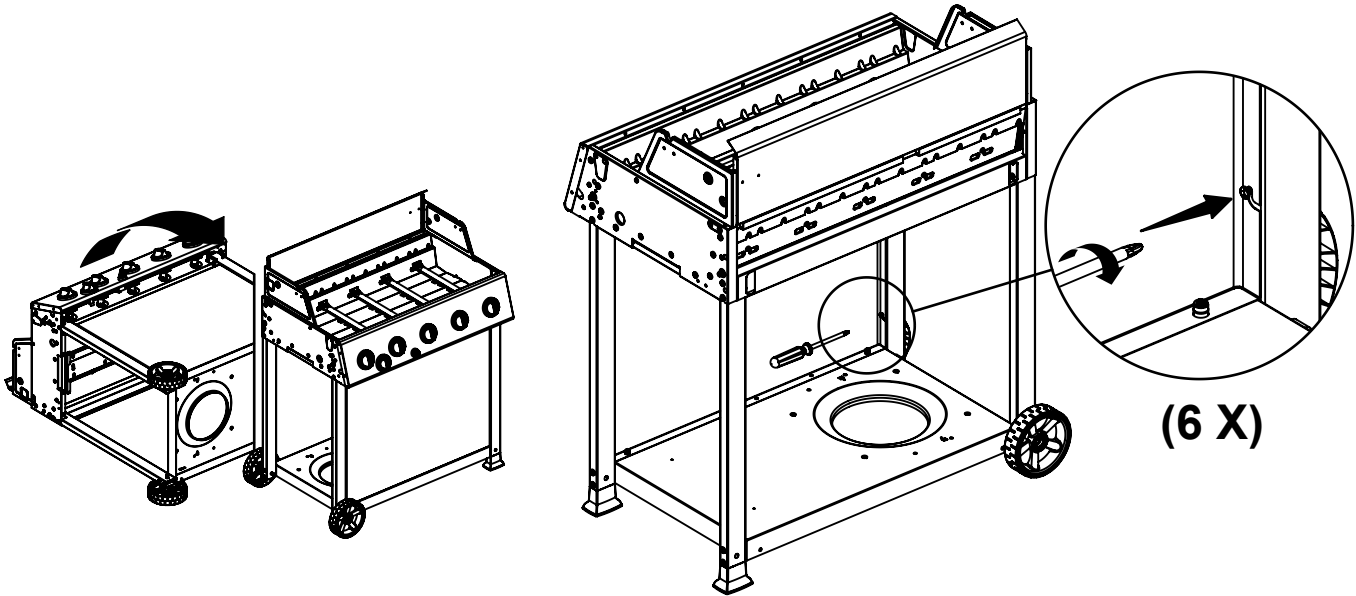
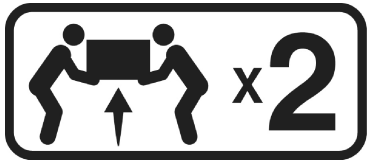

7

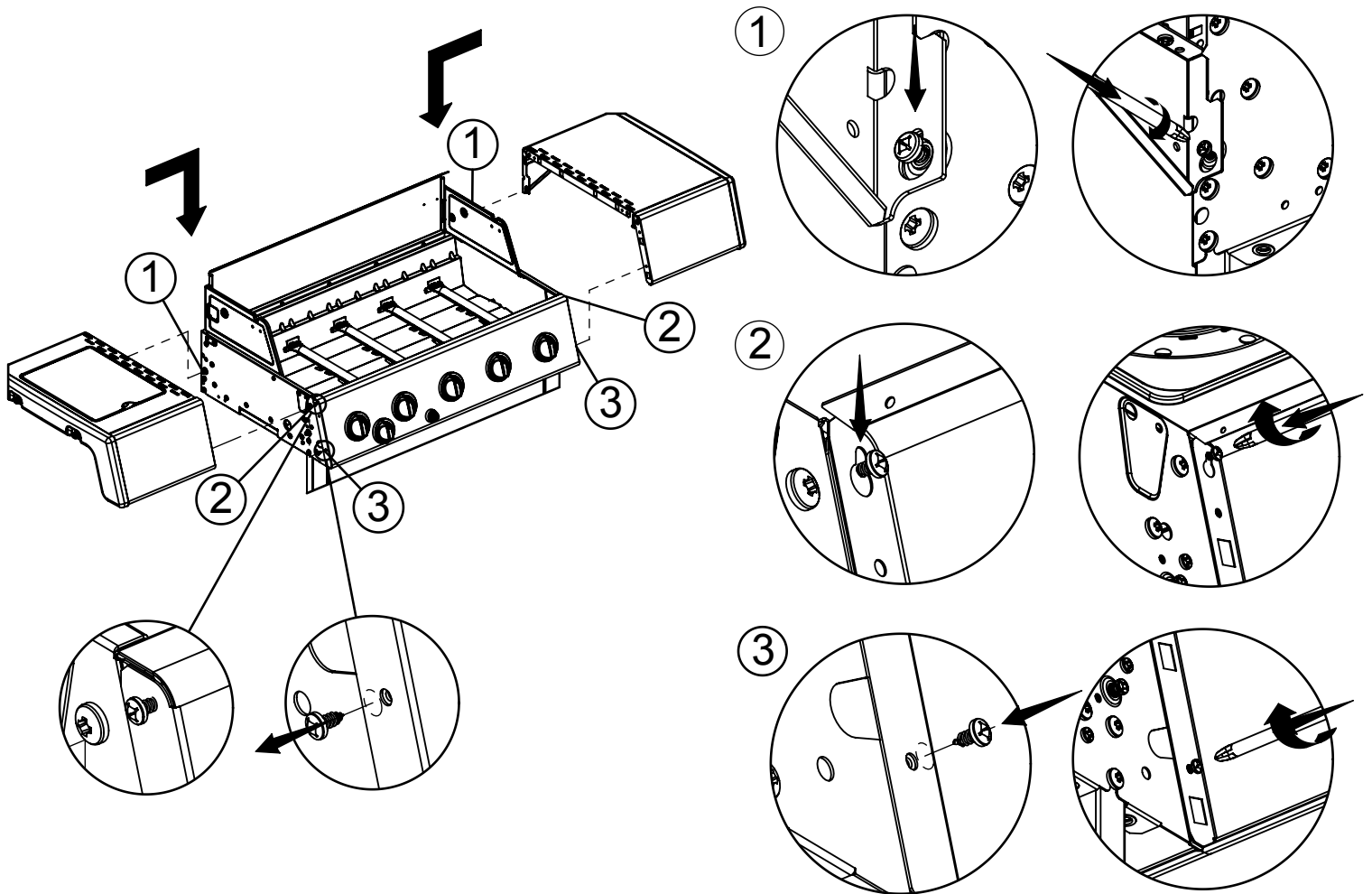

8

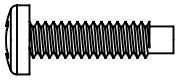
(4) 

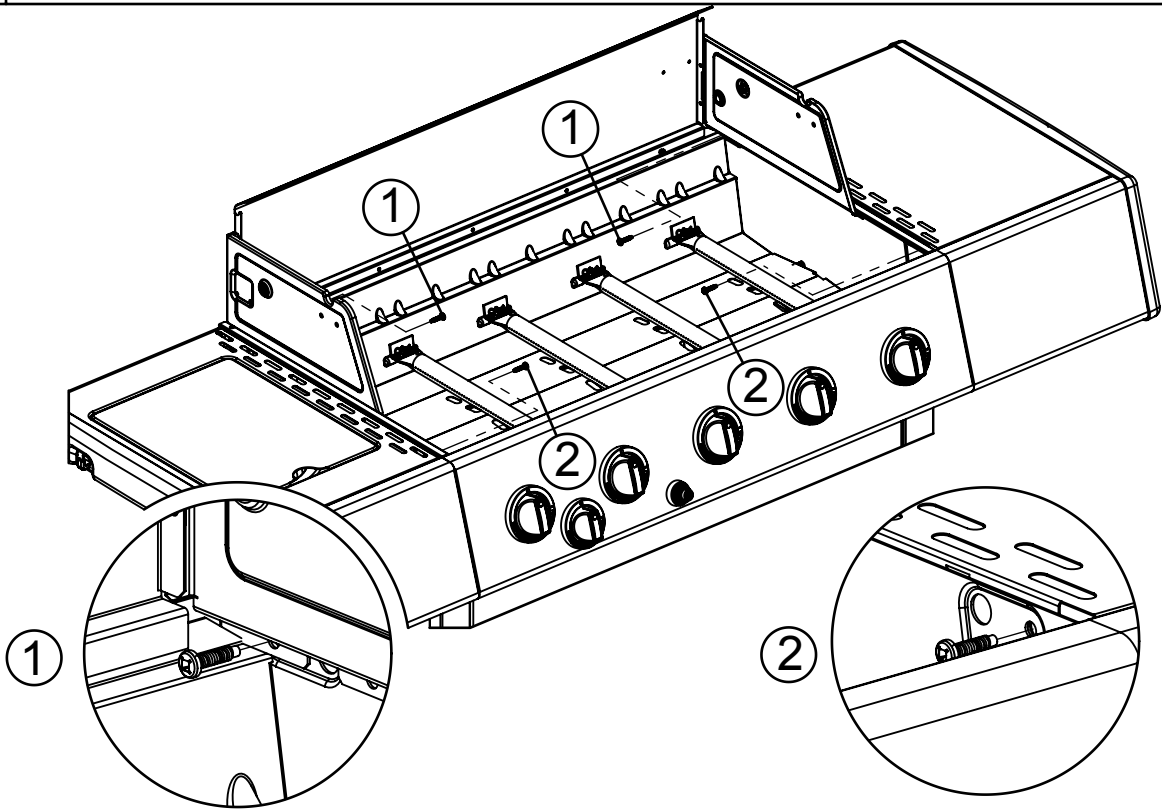

9

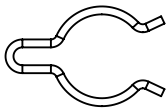
(1) 

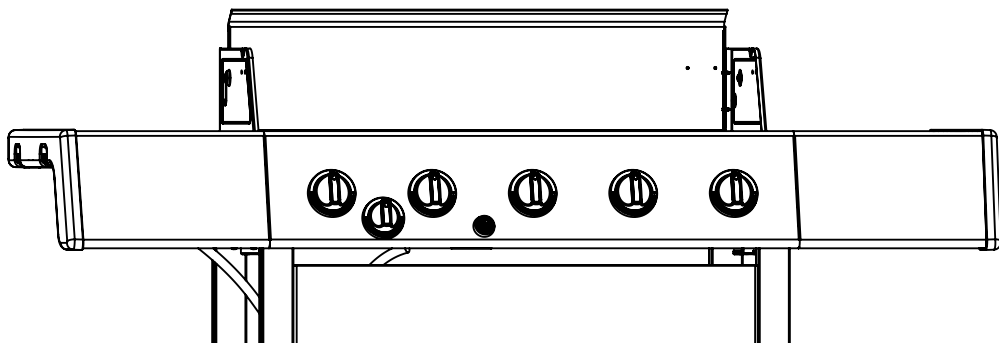
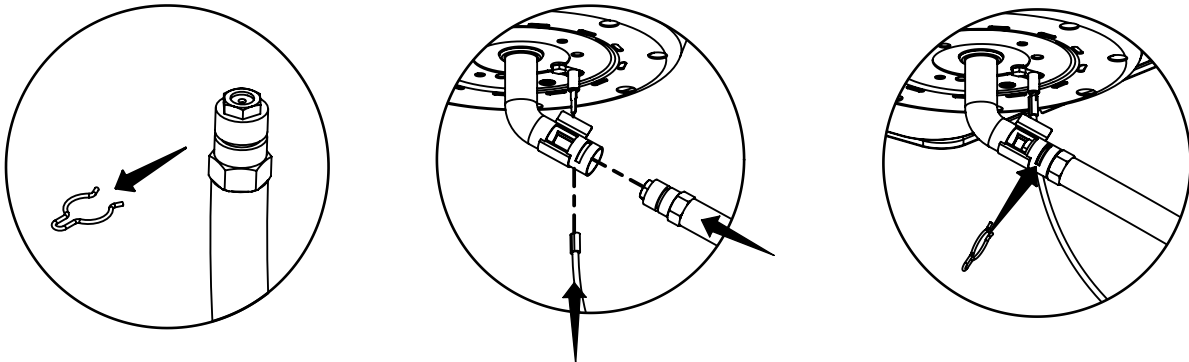

10

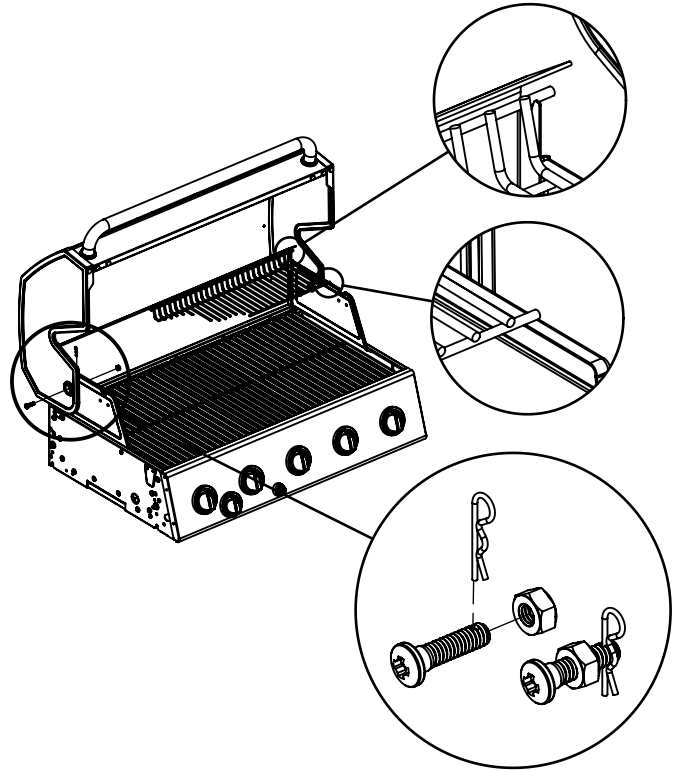
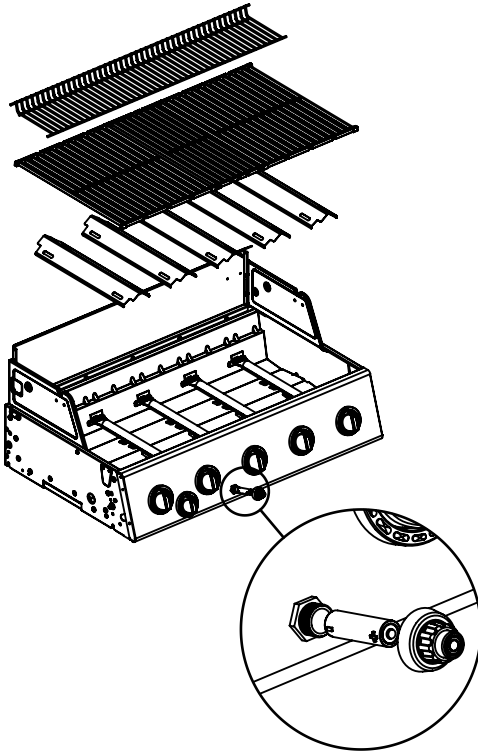
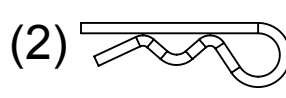
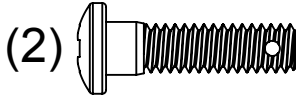

11

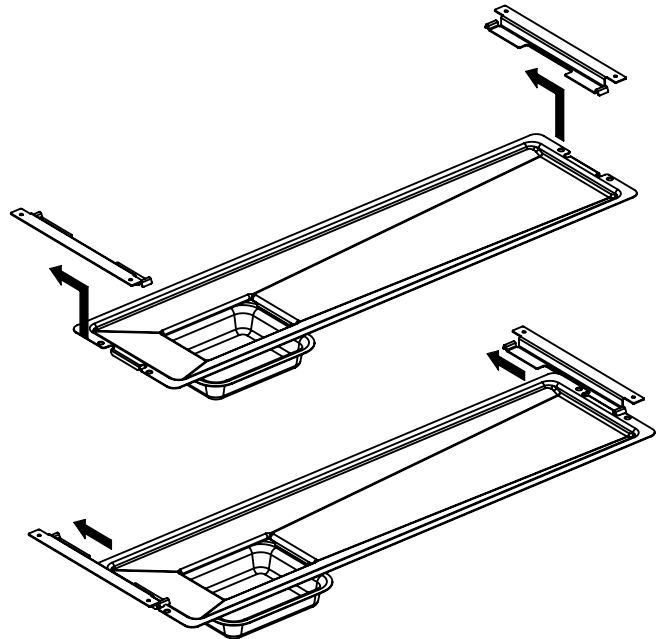
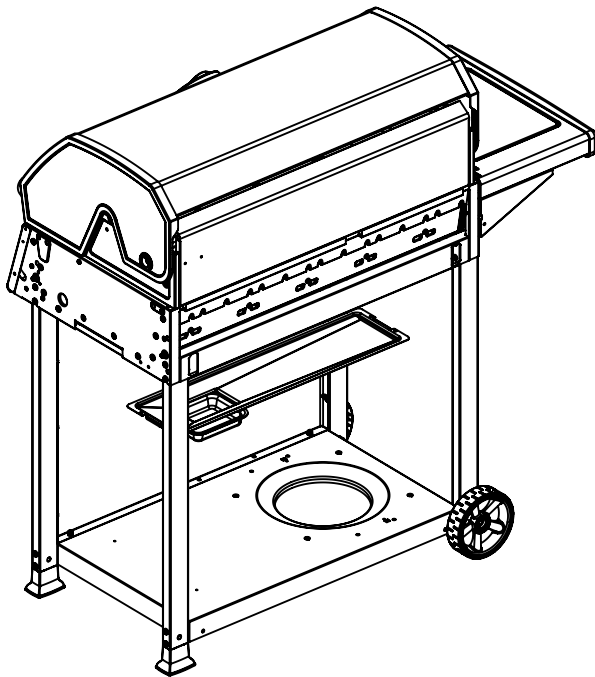

12

(2)  (2) 

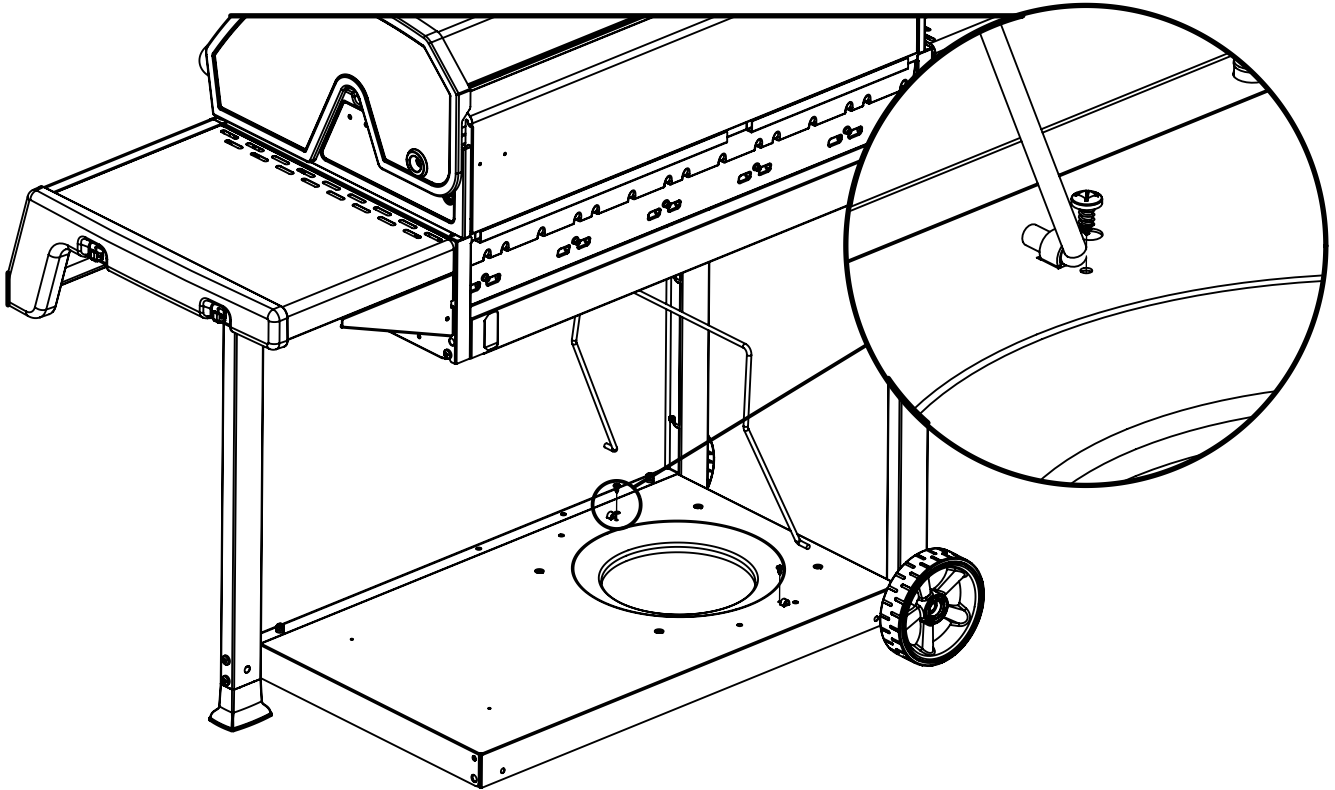

13

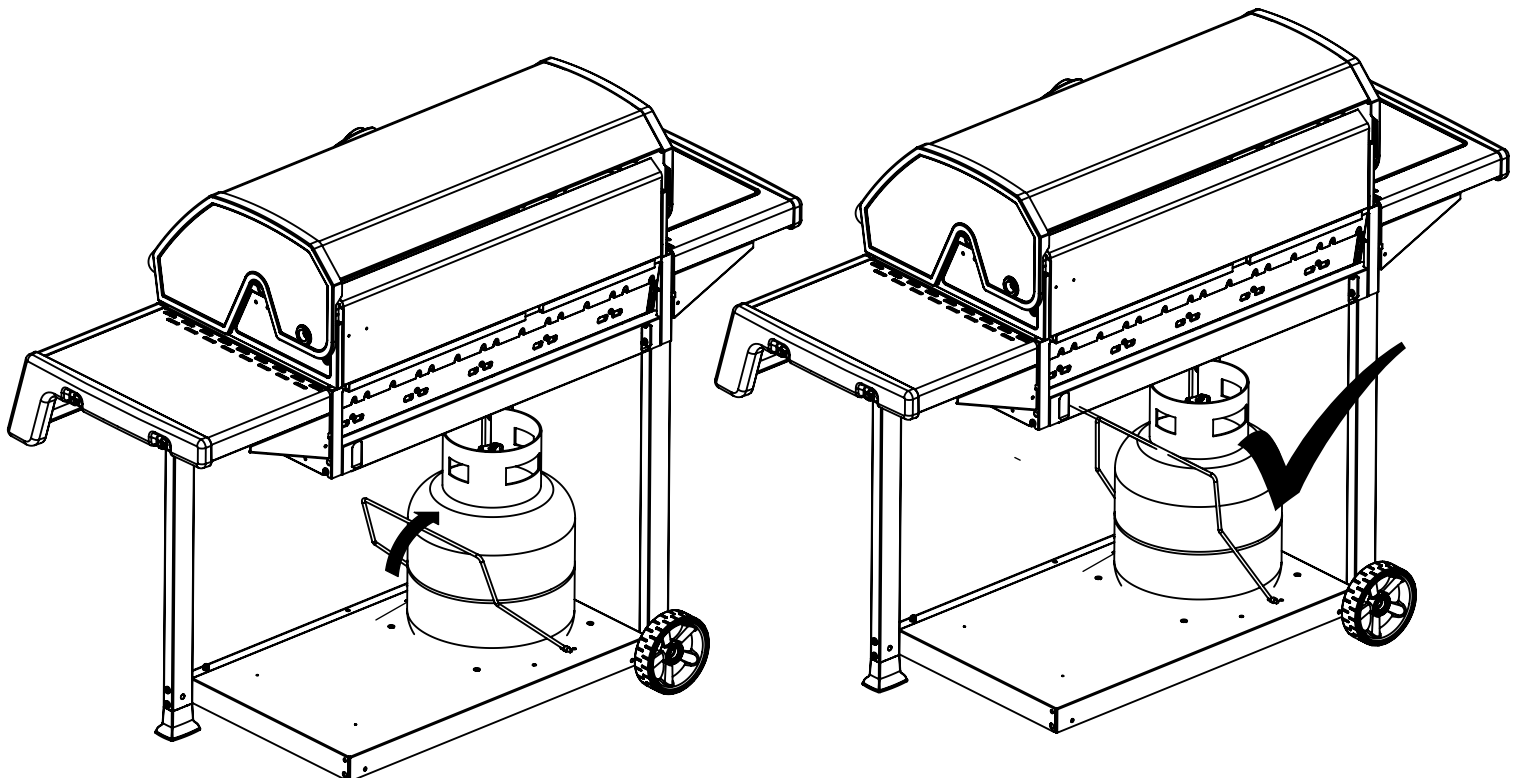

KEY #	ITEM #	DESCRIPTION	DESCRIPTION	DESCRIPCIÓN	5132-54/57	5132-64/67	7132-64/67
1	56104-331	LID - SIDE PANEL - LEFT	COUVERCLE - PANNEAU LATERAL - GAUCHE	TAPA - PANEL LATERAL - IZQUIERDA	1	1	1
2	56104-311	LID - SIDE PANEL - RIGHT	COUVERCLE - PANNEAU LATERAL - DROITE	TAPA - PANEL LATERAL - DERECHA	1	1	1
3	56316-304	LID - OUTER PANEL	COUVERCLE - PANNEAU EXTERIEUR	TAPA - PANEL EXTERIOR	1	1	1
4	56246-30	LID - INNER PANEL	COUVERCLE - PANNEAU INTERIEUR	TAPA - PANEL INTERIOR	1	1	1
5	24006-12A	HANDLE	POIGNÉE	MANGO	1	1	1
6	24009-936	HANDLE BEZEL	MONTURE DE POIGNÉE	BISEL DEL MANGO	2	2	2
8	10081-S50	NAMEPLATE	PLAQUE D'IDENTIFICATION	PLACA CON NOMBRE	•	•	•
	50089-H501				•	•	•
	10081-BM50				•	•	1
	10081-S60				1	1	•
9	10571-5	HEAT INDICATOR	INDICATEUR DE CHALEUR	INDICADOR DE TEMPERATURA	•	•	1
	10571-6				1	1	•
11	52114-131R	PANEL - SIDE UPPER - LEFT	PANNEAU - LATERAL SUPÉRIEUR - GAUCHE	PANEL - LATERAL SUPERIOR - IZQUIERDO	1	1	1
12	52114-111R	PANEL - SIDE UPPER - RIGHT	PANNEAU - LATERAL SUPÉRIEUR - DROITE	PANEL - LATERAL SUPERIOR - DERECHO	1	1	1
15	56006-001P	COOKBOX ASSEMBLY	COOKBOX ASSEMBLEE	CONJUNTO DE CAJA DE COCCIÓN	1	1	1
17	27246-90	GREASE SHEILD	PROTECTION CONTRE LA GRAISSE	PROTECTOR CONTRA GRASA	1	1	1
18	52446-92	HEAT SHEILD - FRONT	PROTECTION CONTRE LA CHALEUR - FRONTAL	PROTECTOR CONTRA CALOR - FRENTE	1	1	1
22	52336-121	REAR - BRACE	ÉTRÉSILLON - ARRIÈRE	POSTERIOR - SOPORTE	1	1	1
23	52316-151	PANEL - HOOD	PANNEAU DE LA CUVE	PANEL - CUBIERTA	1	1	1
25	52904-144LP	BURNER - MAIN	BRÛLEUR - PRINCIPAL	QUEMADOR - PRINCIPAL	5/•	5/•	5/•
	52904-144NG				•/5	•/5	•/5
26	52226-014	COLLECTOR BOX - FRONT LOWER	RECIPIENT - FRONTAL INFÉRIEUR	CAJA RECOLECTORA - DELANTERA INFERIOR	1	1	1
27	52216-014	COLLECTOR BOX - FRONT UPPER	RECIPIENT - FRONTAL SUPÉRIEUR	CAJA RECOLECTORA - DELANTERA SUPERIOR	1	1	1
28	52016-234	CONTROL COVER	PANNEAU DE CONTROLE	CUBIERTA DE CONTROL	•	1	1
	52016-114				1	•	•
29	59006-034	CONTROL ASSEMBLY	SOUPAPE	MECANISMO DE CONTROL	•	1/•	1/•
	59006-037				•	•/1	•/1
	59006-014				1/•	•	•
	59006-017				•/1	•	•
30	S13470-091	HOSE - SIDE BURNER	TUYAU - BRÛLEUR DE CÔTÉ	MANGUERA - QUEMADOR LATERAL	•	1/•	1/•
	S13470-132				•	•/1	•/1
31	10114-20	HOSE & REGULATOR	TUYAU ET REGULATEUR PL	MANGUERA Y REGULADOR	1/•	1/•	1/•
	10111-K45	NATURAL GAS HOSE	TUYAU DE GAZ NATUREL	MANGUERA PARA GAS NATURAL	•/1	•/1	•/1
38	22001-168	CONTROL KNOB - BEZEL	BOUTON DE CONTROLE - MONTURE	PERILLA DE CONTROL - BISEL	•	1	1
39	22002-268	CONTROL KNOB - BEZEL	BOUTON DE CONTROLE - MONTURE	PERILLA DE CONTROL - BISEL	5	5	5
40	10472-K37	CONTROL KNOB	BOUTON DE CONTROLE	PERILLA DE CONTROL	•	•	•
	10472-K431				5	5	5
41	50479-168	CONTROL KNOB	BOUTON DE CONTROLE	PERILLA DE CONTROL	•	•	•
	10472-K231				•	1	1
42	10342-247	ELECTRONIC IGNITOR	ALLUMAGE ÉLECTRONIQUE	ENCENDEDOR ELECTRÓNICO	•	1	1
	10342-246				1	•	•
43	10342-E13	ELECTRODE	ÉLECTRODE	ELECTRODO	2	2	2
44	52249-401	FLAV-R-WAVE ®	FLAV-R-WAVE ®	FLAV-R-WAVE®	•	•	•
	52209-404				5	5	5
45A	52002-181	GRID - PORCELAIN	GRILLE EN PORCELAINE	REJILLA - PORCELANA	2	2	2
45B	52007-181	GRID - PORCELAIN	GRILLE EN PORCELAINE	REJILLA - PORCELANA	1	1	1
46	52006-091	GRID - WARMING RACK	GRILLE - MAINTIEN AU CHAUD	REJILLA - ESTANTE PARA CALENTAR	1	1	1
47	57056-902	GREASE TRAY	PLATEAU A GRAISSE	BANDEJA RECOLECTORA DE GRASA	1	1	1
48	22049-102	GREASE TRAY - BRACKERT	PLATEAU A GRAISSE - FERROVIAIRE	BANDEJA RECOLECTORA DE GRASA - SOPORTE	2	2	2
49	52009-902	GREASE PAN	CUVETTE A GRAISSE	BANDEJA PARA LA GRASA	1	1	1
50	52349-921	COVER	COUVERCLE DE FINITION	CUBIERTA DE ACABADO	1	1	1
51	52344-921	COVER	COUVERCLE DE FINITION	CUBIERTA DE ACABADO	1	1	1
59	51299-101	LEG - FORNT	LEG - AVANT	PATA - FACHADA	2	2	2
60	51399-101	LEG - REAR	LEG - ARRIÈRE	PATA - TRASERO	2	2	2
61	52339-202	LEG - BRACKET	LEG - SUPPORT	PARA - SOPORTE	2	2	2
65	51696-141R	CABINET - LOWER SHELF	TABLETTE INFÉRIEURE	GABINETE - ESTANTE INFERIOR	1/•	1/•	1/•
	51696-171R				•/1	•/1	•/1
67	51246-911R	FRONT PANNEL	AVANT PANNEAU	PANEL FRONTAL	1	1	1
69	51429-158	RESIN FOOT	RESINE - PIED	TOPE DE RESINA	2	2	2
70	10892-608	WHEEL	ROUE	RUEDA	2	2	2
80	53104-11S1	SIDE SHELF	TABLETTE DE CÔTÉ	ESTANTE LATERAL	1	1	1
	53104-13S1	SIDE SHELF	TABLETTE DE CÔTÉ	ESTANTE LATERAL	1	•	•
82	53104-15S1	SIDE SHELF - SIDE BURNER	TABLETTE DE CÔTÉ - BRÛLEUR DE CÔTÉ	ESTANTE LATERAL - QUEMADOR LATERAL	•	1	1
83	53404-114	SIDE SHELF - FASCIA	TABLETTE DE CÔTÉ - FASCIA	ESTANTE LATERAL - PLACA FRONTAL	2	2	2
84	53184-138	SIDE SHELF - END CAP - LEFT	TABLETTE DE CÔTÉ - FASCIA - GAUCHE	ESTANTE LATERAL - TAPA DE EXTREMO - IZQUIERDA	1	1	1
85	53184-118	SIDE SHELF - END CAP - RIGHT	TABLETTE DE CÔTÉ - FASCIA - DROIT	ESTANTE LATERAL - TAPA DE EXTREMO - DERECHA	1	1	1
86	10390-E10	SIDE BURNER	BRÛLEUR DE CÔTÉ	QUEMADOR LATERAL	•	1	1
87	53004-271	SIDE BURNER - BODY	BRÛLEUR DE CÔTÉ - CORPS	QUEMADOR LATERAL - CUERPO	•	1	1
88	53000-251	SIDE BURNER - COVER	BRÛLEUR DE CÔTÉ - COUVERCLE	QUEMADOR LATERAL - CUBIERTA	•	1	1
89	63139-981	SIDE BURNER GRID	BRÛLEUR DE CÔTÉ - GRILLE	REJILLA DEL QUEMADOR LATERAL	•	1	1
90	23030-631	SIDE SHELF - BRACKET - LEFT	TABLETTE DE CÔTÉ - ÉTRÉSILLON - GAUCHE	ESTANTE LATERAL - SOPORTE - IZQUIERDO	1	1	1
91	23030-611	SIDE SHELF - BRACKET - RIGHT	TABLETTE DE CÔTÉ - ÉTRÉSILLON - DROIT	ESTANTE LATERAL - SOPORTE - DERECHO	1	1	1
95	10342-T21	SIDE BURNER ELECTRODE	ÉLECTRODE DU BRÛLEUR DE CÔTÉ	ELECTRODO DEL QUEMADOR LATERAL	•	1	1
100	21299-19	WIRE - TANK RETAINER	FIL - RETENUE DE RÉSERVOIR	ALAMBRE - RETÉN DEL TANQUE	1	1	1
102	21239-13	WIRE - CLIP	FIL - CLIP	ALAMBRE - GANCHO	2	2	2
130	Y-12835	SCREW - #6 X 1/4	VIS - #6 X 1/4	TORNILLO - #6 X 1/4	•	2	2
131	S21125	SCREW - #8 X 3/8	VIS - #8 X 3/8	TORNILLO - #8 X 3/8	16	16	16
132	S21124	SCREW - #8 X 1/2	VIS - #8 X 1/2	TORNILLO - #8 X 1/2	15	15	15
133	Y-12646	SCREW - SHOULDER #8 X 1/2	VIS - SHOULDER #8 X 1/2	TORNILLO - DE HOMBRO #8 X 1/2	10	12	12
134	Y-29304	SCREW - #10-24 X 3/8	VIS - #10-24 X 3/8	TORNILLO - #10-24 X 3/8	16	16	16
135	S35094	SCREW - #10-24 X 5/8	VIS - #10-24 X 5/8	TORNILLO - #10-24 X 5/8	1	1	1
136	Y-29310	SCREW - #10-24 X 3/4	VIS - #10-24 X 3/4	TORNILLO - #10-24 X 3/4	6	6	6
137	Y-12855	SCREW - 1/4-20 X 3/8	VIS - 1/4-20 X 3/8	TORNILLO - 1/4-20 X 3/8	28	28	28
138	Y-12865	SCREW - 1/4-20 X 1/2	VIS - 1/4-20 X 1/2	TORNILLO - 1/4-20 X 1/2	2	2	2
139	Y-11546	SCREW - SHOULDER 1/4-20 X 5/8	VIS - SHOULDER - 1/4-20 X 5/8	TORNILLO - DE HOMBRO 1/4-20 X 5/8	4	4	4
140	Y-12310	SCREW - 1/4-20 X 3/4	VIS - 1/4-20 X 3/4	TORNILLO - 1/4-20 X 3/4	2	2	2
142	Y-11562	SCREW - 1/4-20 X 2 1/2	SCREW - 1/4-20 X 2 1/2	TORNILLO - 1/4-20 X 2 1/2	16	16	16
150	Y-29307	NUT - #10-24	ÉCROU - #10-24	TUERCA - #10-24	2	2	2
151	Y-11793	NUT - 1/4-20	ÉCROU - 1/4-20	TUERCA - #1/4-20	2	2	2
170	10240-23	HINGE PIN	GOUPILLE DE CHARNIÈRE	CLAVIJA DE BISAGRA	2	2	2
171	S21233	CLIP	CLIP	GANCHO	8	8	8
172	Y-29310	BURNER SCREW	VIS DU BRÛLEUR	TORNILLO DEL QUEMADOR	4	4	4
173	10240-13	WHEEL PIN	PIN ESSIEU	CLAVIJA DE LA RUEDA	2	2	2
180	Y-11231	LID BUMPER - ROUND	BUTOIR DU COUVERCLE - CERCLE	TOPE DE LA TAPA - REDONDO	4	4	4
182	20005-000	MATCH LIGHT CHAIN	MATCH CHAINE LEGERE	CADENA PARA ENCENDEDOR	1	1	1

