

This Owner's Manual is provided and hosted by [Appliance Factory Parts](#).



Broil-Mate 7032-64 Owner's Manual

[Shop genuine replacement parts for Broil-Mate 7032-64](#)



[Find Your Broil-Mate Grill Parts - Select From 682 Models](#)

----- Manual continues below part list -----

Available Replacement Parts for Broil-Mate 7032-64

18013	LID HEAT INDICATOR - LARGE - SS
S21233	HITCH PIN CLIP +
Y-12860	SCREW-THCP 1/4-20 X 1-TY-C A04
Y-11793	NUT HEX 1/4 20 JS500 +
Y-12835	SCREW-PHCP 6-32X1/4 TY-F JS500
Y-29307	NUT HEX #10-24 JS500
10240-13	WHEEL PIN
Y-11230	HAIRPIN COTTER SIDE BURNER +
Y-11546	SCREW PHCP 1/4-20X5/8 INCH A04#A
S21124	SCREW PHCP #8 X 12 +
10390-E10	BURNER SIDE 10BTU W/ELEC #8 +
Y-29304	SCREW PHCP #10 24x3/8
S21125	SCREW 8 X 3/8 PAN HEAD
S35094	SCREW #10-24 X 5/8
10342-246	IGNITOR ELECTRONIC TRIPLE +
Y-11231	LID BUMPER ROUND BLK
10342-E13	ELECTRODE W/WIRE
10342-T18	WIRE ELECTRODE S/B 600 +
24006-12A	HANDLE LID ASSY 625
52007-181	COOKING GRID 550 PORC BLK +
10240-23	LID PIN 1/4-20
Y-29310	SCREW #10-24 3/4 TRUSS QU
52316-151	FIREBOX 550 HOOD PANEL PORC
59006-034	CONTROL ASSY 5V S/B LP
59006-037	CONTROL ASSY 5V S/B NG
52006-991	WARMING RACK 550 PORC +
20005-000	HARDWARE BAG STICK & CHAIN SS
44089-60	NAMEPLATE PATRIOT
52016-903	COLLECTOR BOX ASSEMBLY 625
80012	regulator and hose READ ADD. INFO

10892-608	WHEEL 6 INCH
22049-102	GREASE TRAY BRACKET GAL 330/440/550
51429-158	RESIN FOOT 330/440
53184-118	SHELF END CAP RHS 330/440
53184-138	SHELF END CAP LHS 330/440
53404-114	SHELF FRONT FACIA RHS 330/440
53009-951	SIDE BURNER TRIVET BLK
Y-11235	LID BUMPER HEX-BLK AB
Y-12865	SCREW 1/4 X 20X1/2 TYPE-C PHCP
52249-404	HEAT TENT SS
53104-111	SHELF RHS BLK 330/440
59006-014	CONTROL ASSY 550 5V LP
59006-017	VALVE ASSY 550 5V MAIN NG
S21242	CLIP BURNER TUBE MOUNT SS
52924-144R	BURNER - MAIN
57056-901	GREASE TRAY BLK
Y-11544S	SCREW - BURNER #10-24 X 3/8
10111-K45	HOSE 3/8 INCH ASSEMBLY NG 10 FOOT +
10081-69BM	NAMEPLATE BROILMATE
24009-936	HANDLE RING
10342-247	IGNITOR ELECTRONIC +
10472-K431	CONTRL KNOB RESIN LRG BLCK W/SS BA STRIP
22001-168	CONTROL KNOB BEZEL SML
22002-268	CONTROL KNOB BEZEL LARGE
52009-901	GREASE PAN - BLACK HIGH HEAT PAINT
52904-144NG	BURNER ASSY MAIN SINGLE TUBE + NG
27249-904	GREASE SHIELD MODULAR, 6.5 x 6

OMC

ASSEMBLY MANUAL & PARTS LIST • MANUEL DE MONTAGE & LISTE DE PIÈCES • MANUAL DE ARMADO Y LISTA DE PARTES



STERLING 5032-64/67

HUNTINGTON 6032-64/67

broil-mate 7032-64/67



STERLING 5132-64/67

HUNTINGTON 6132-64/67

broil-mate 7132-64/67



STERLING 5032-54/57

HUNTINGTON 6032-54/57

broil-mate 7032-54/57



STERLING 5132-54/57

HUNTINGTON 6132-54/57

broil-mate 7132-54/57

RETAIN FOR FUTURE REFERENCE • VEUILLEZ CONSERVER POUR REFERENCE ULTERIEURE • CONSERVAR PARA FUTURAS CONSULTAS

1-800-265-2150

info@omcbbq.com

Onward
MANUFACTURING COMPANY
SINCE 1906
1000 EAST MARKET STREET
HUNTINGTON, INDIANA, 46750, USA

50084-C90 Rev D 11/15

1

(4)

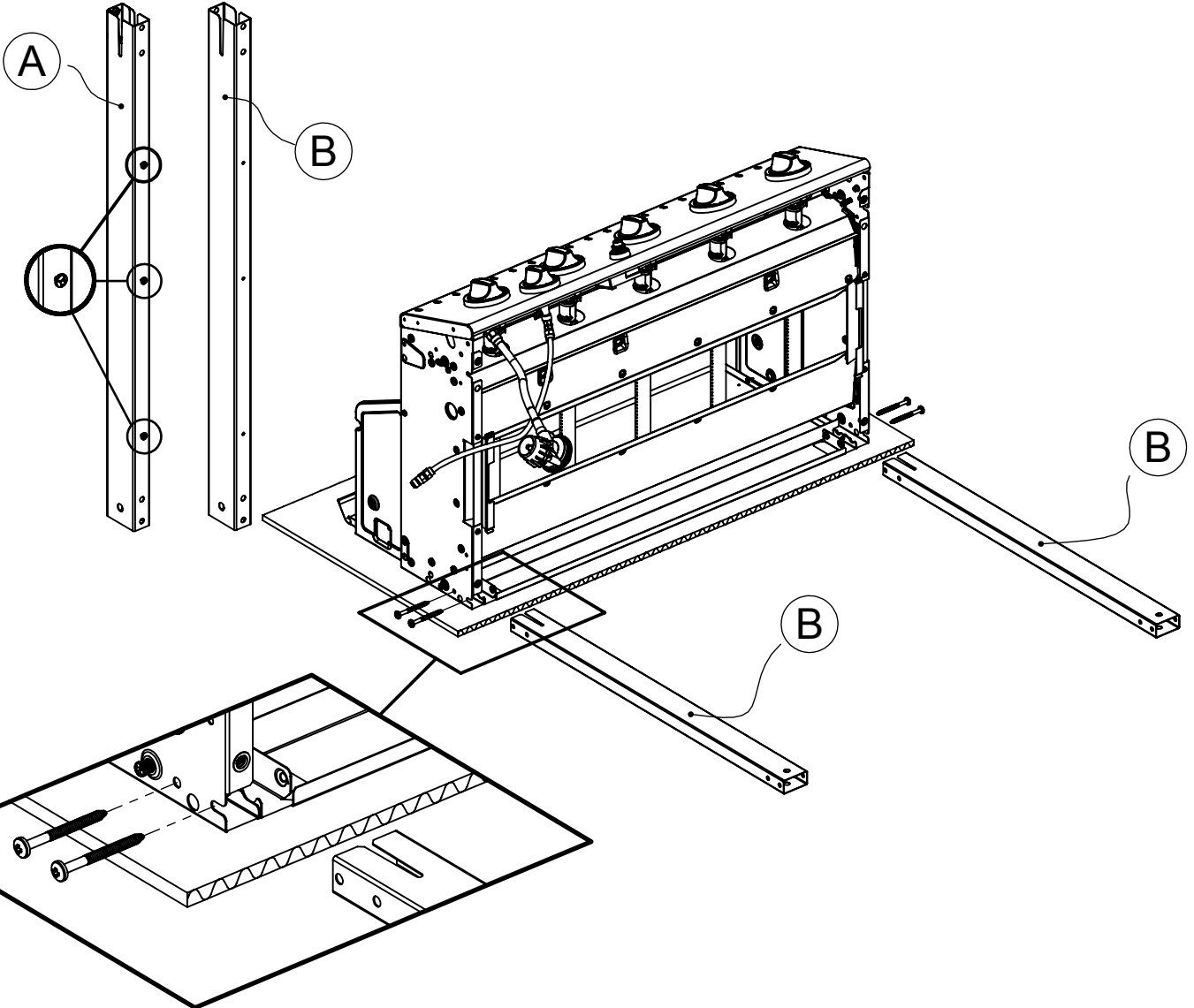
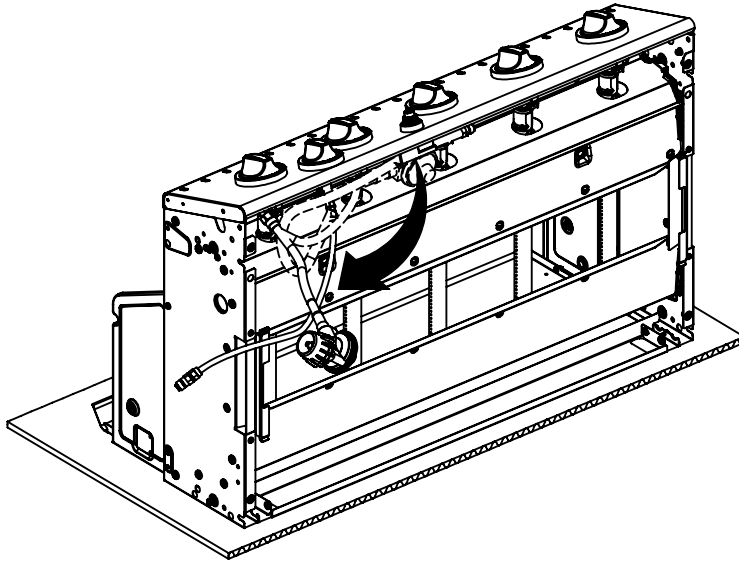

2

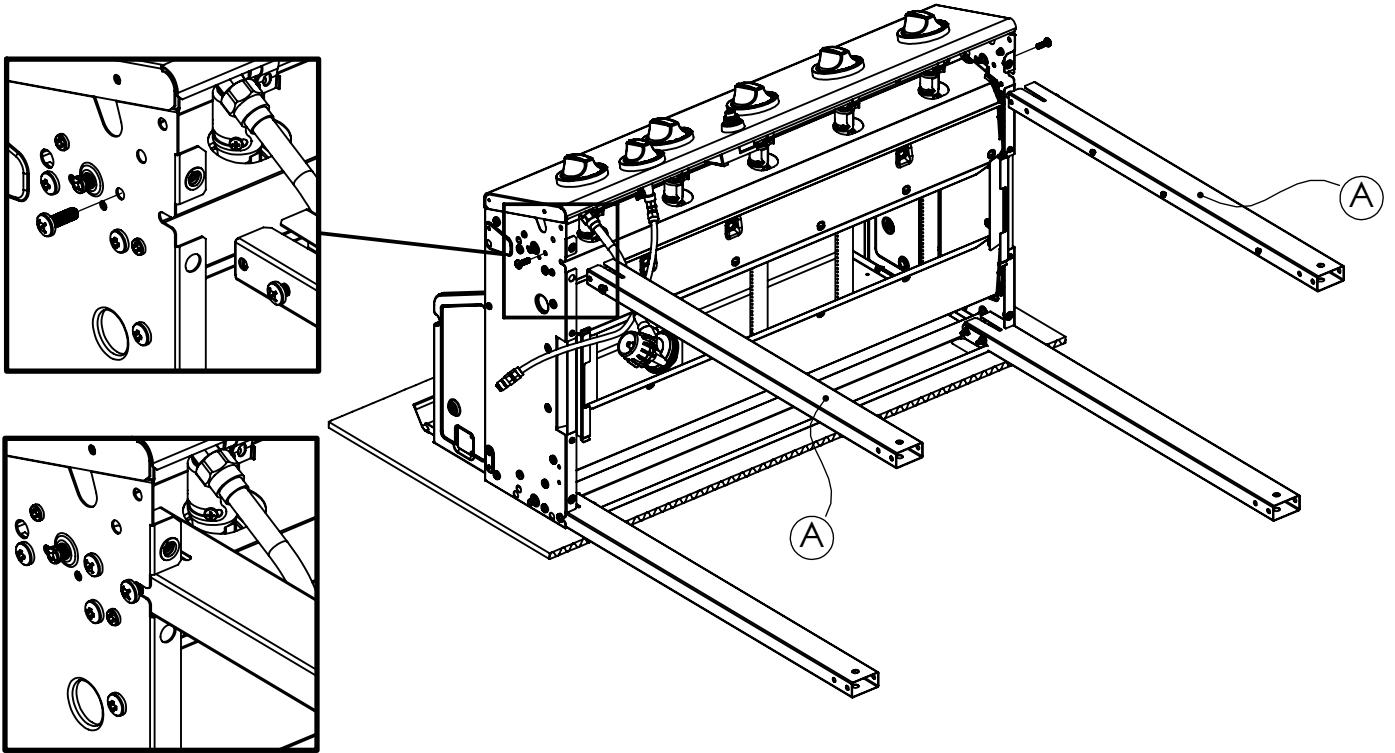
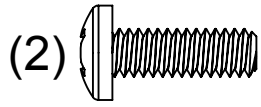

3

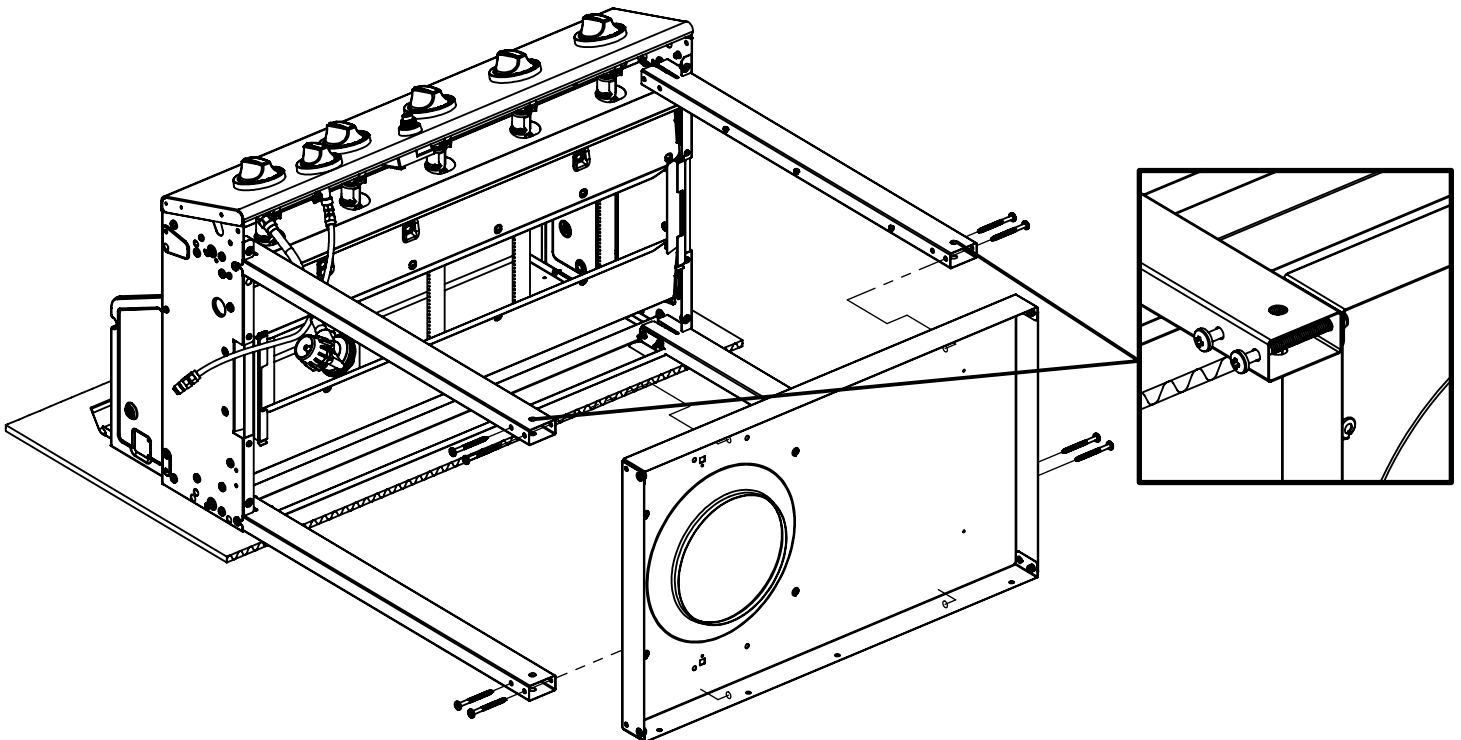
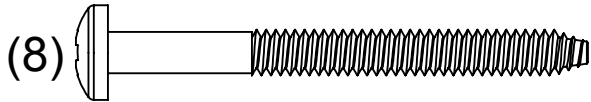

4

(2) 

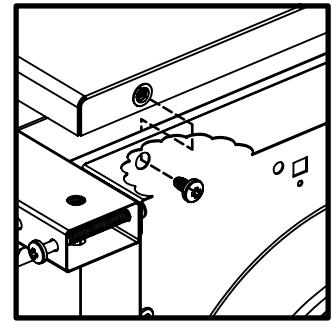
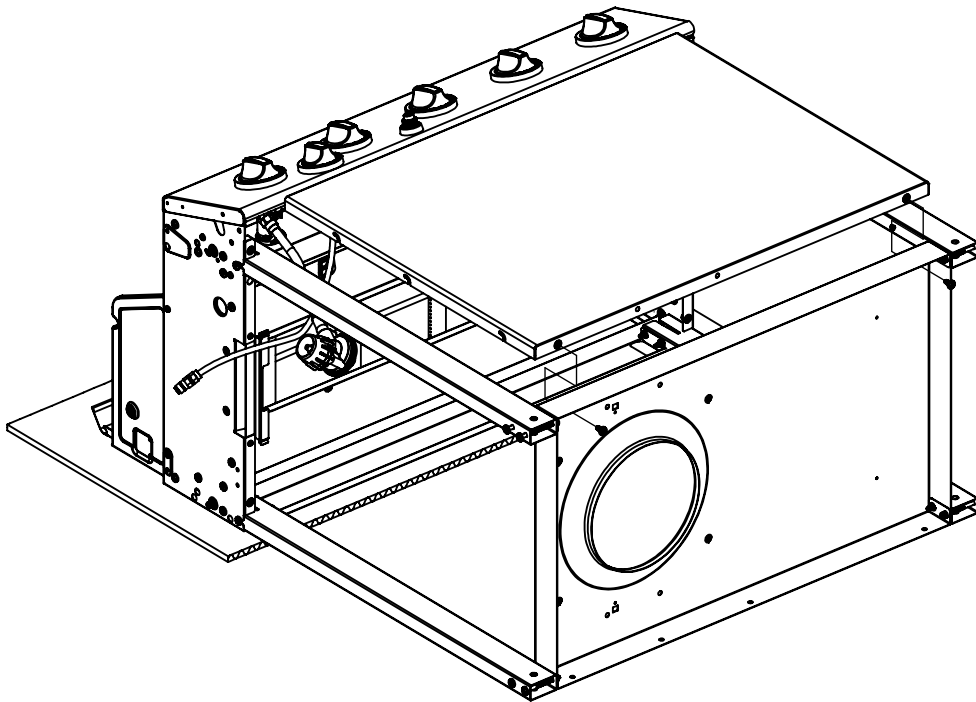

5

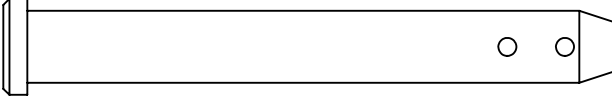
(2) 

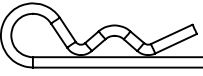
(2) 

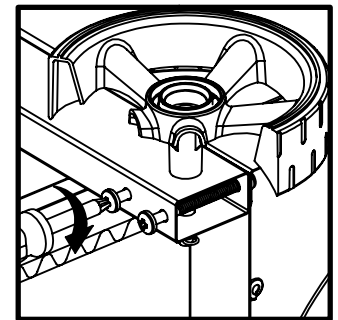
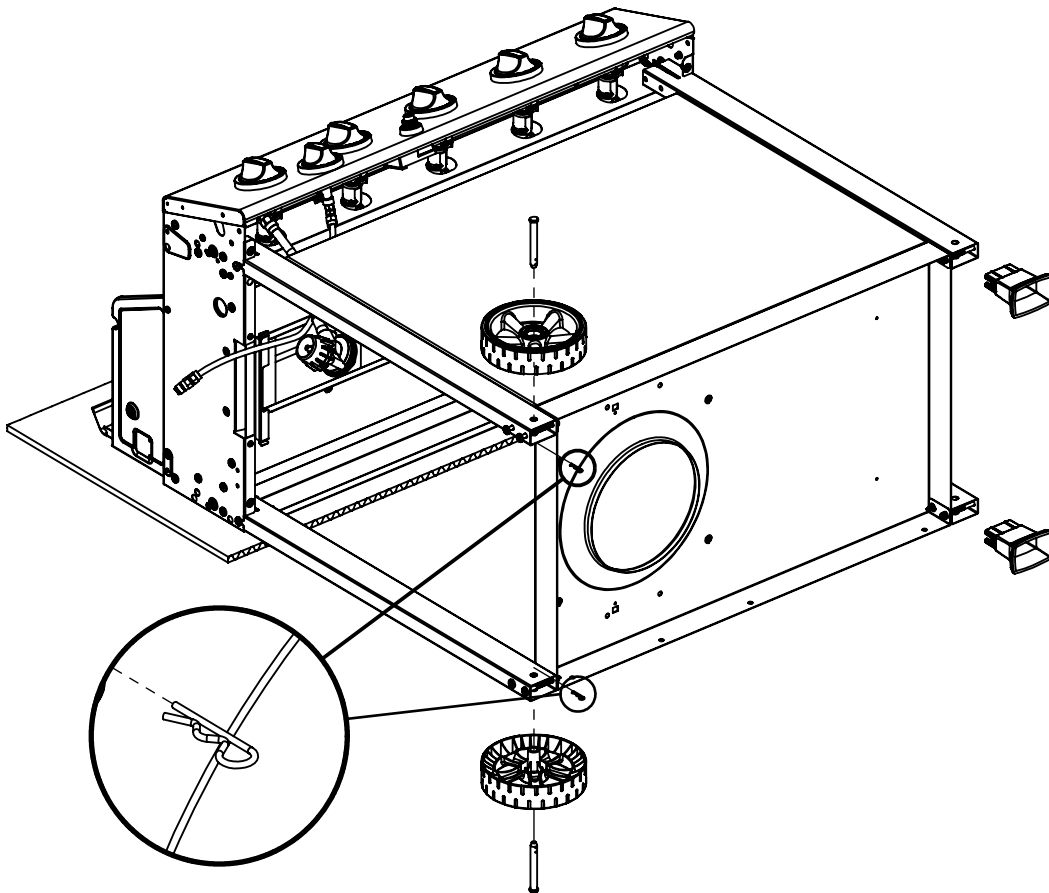

(x-8)

6

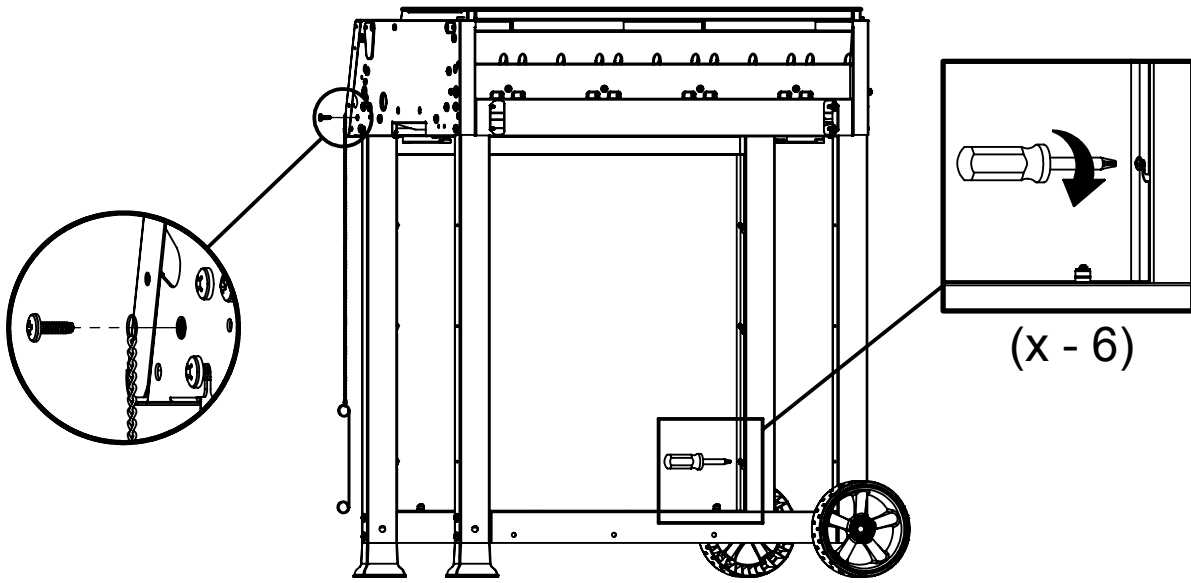

7

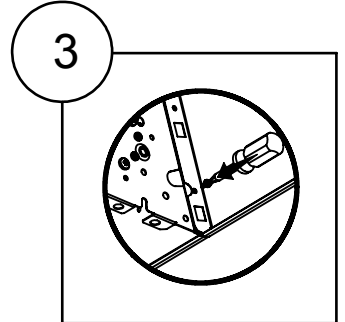
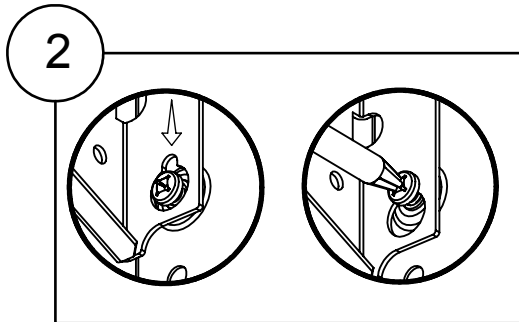
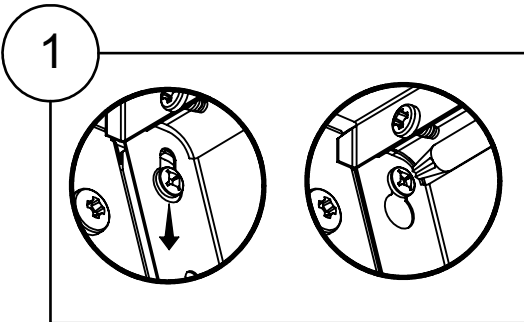
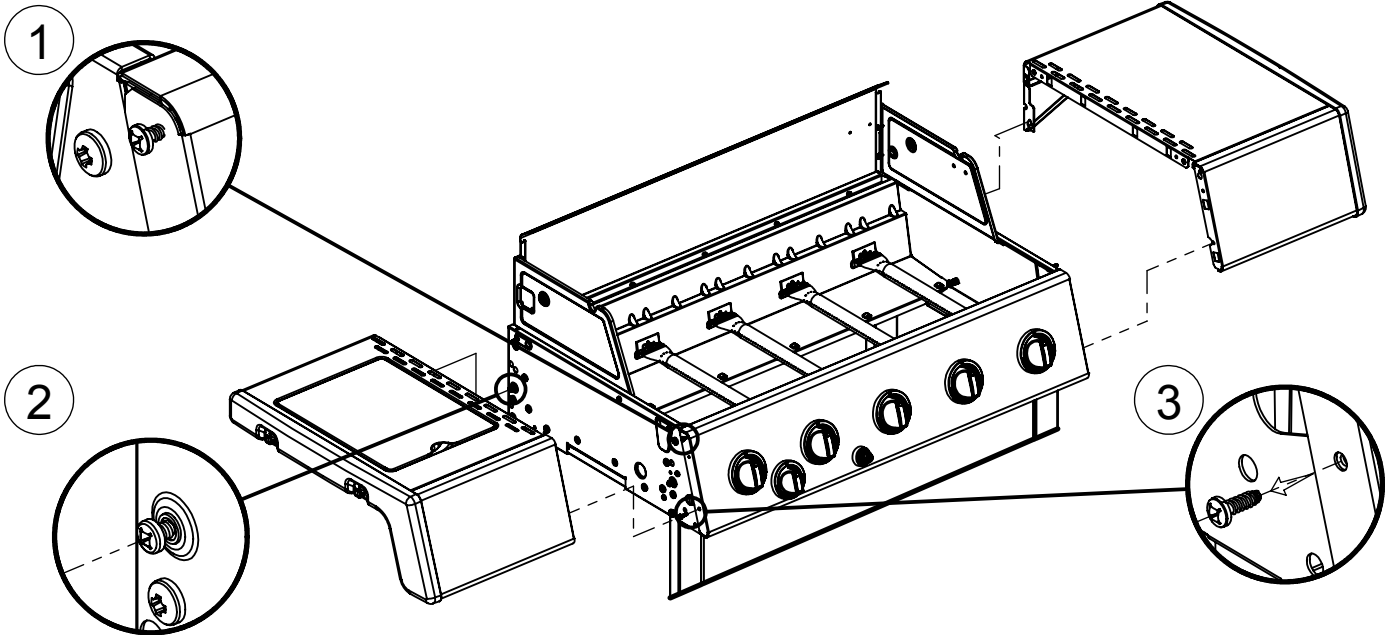

8

(4)

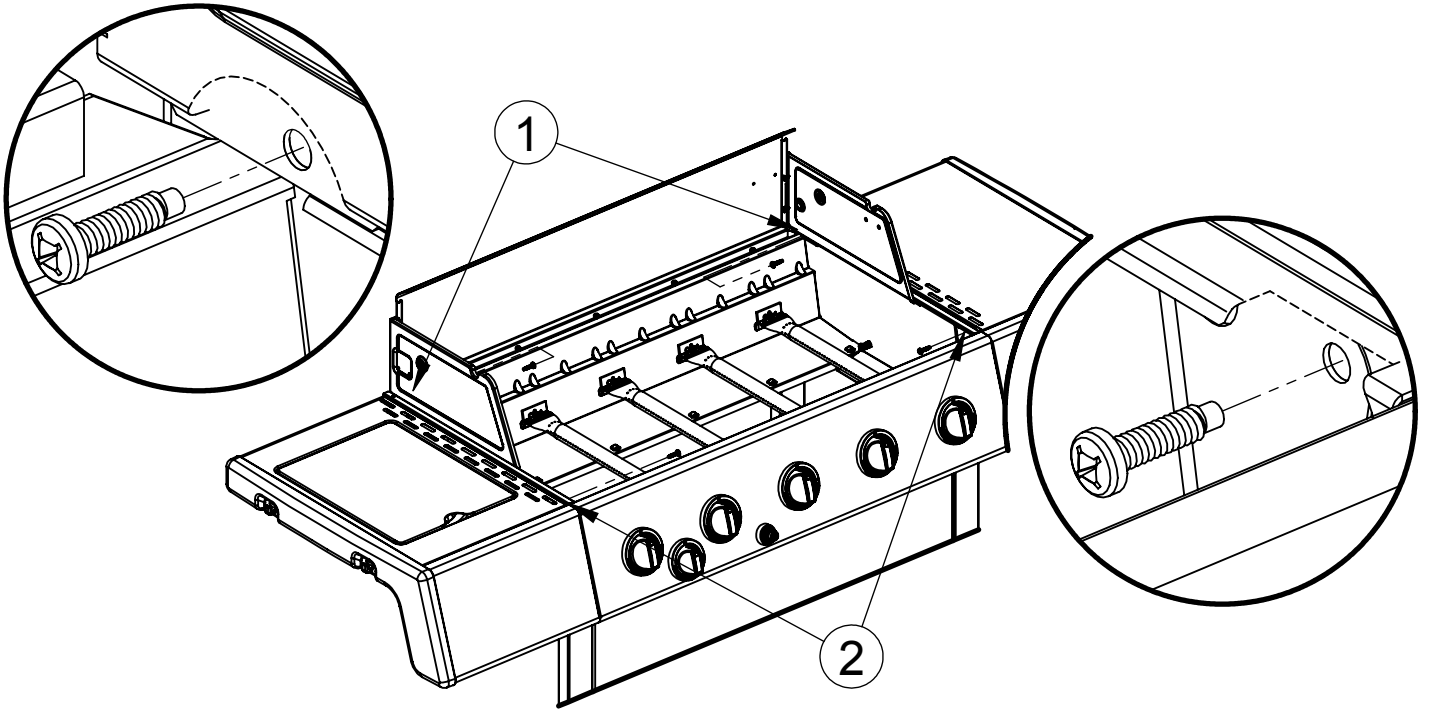

9

(1)

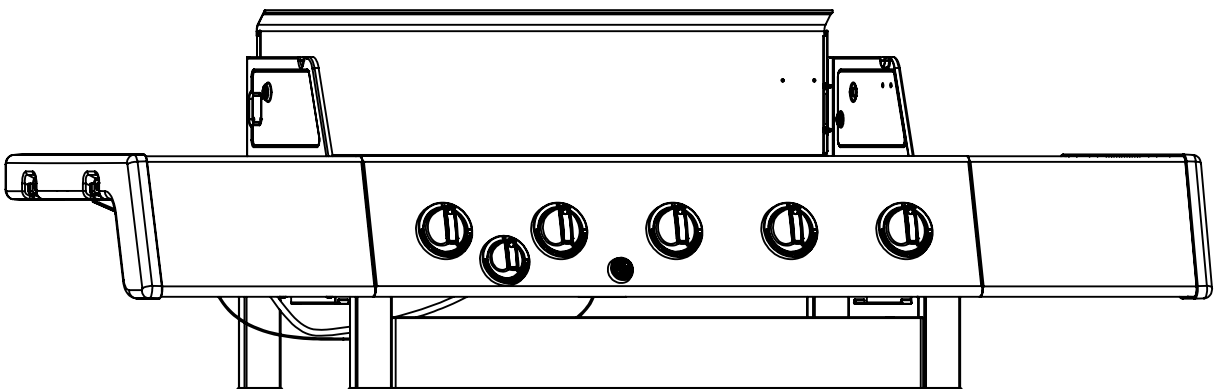
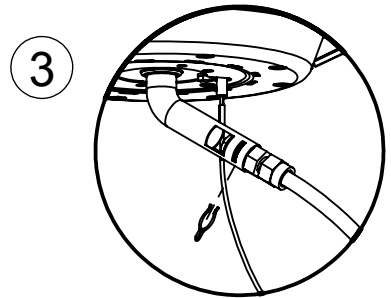
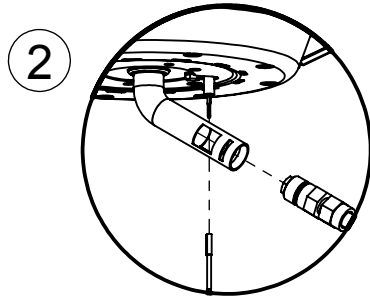
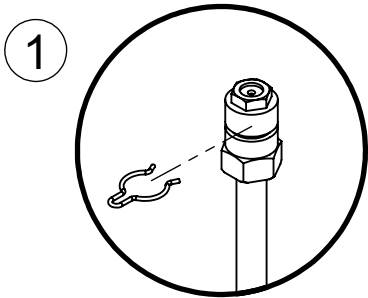
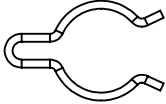

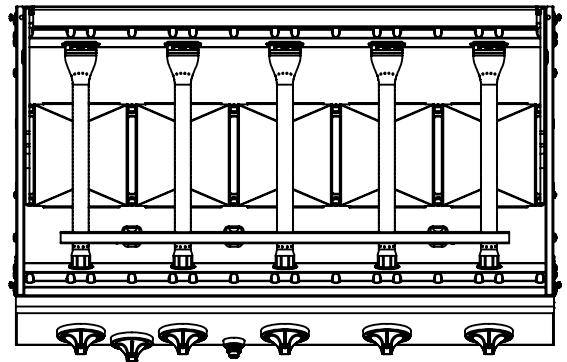
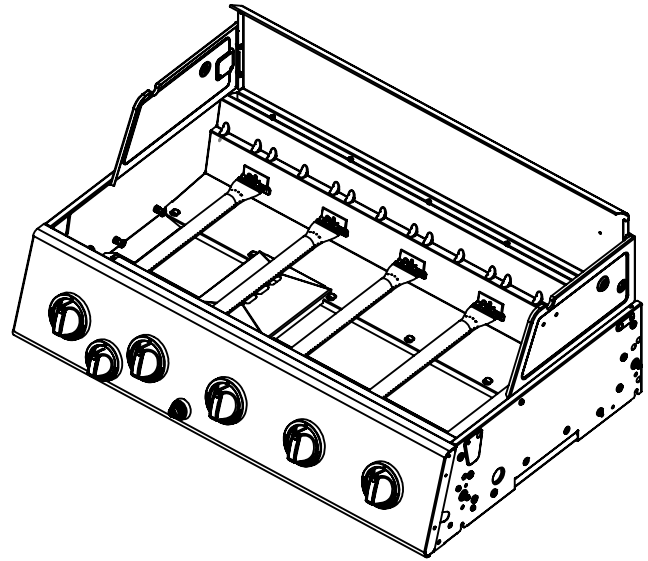
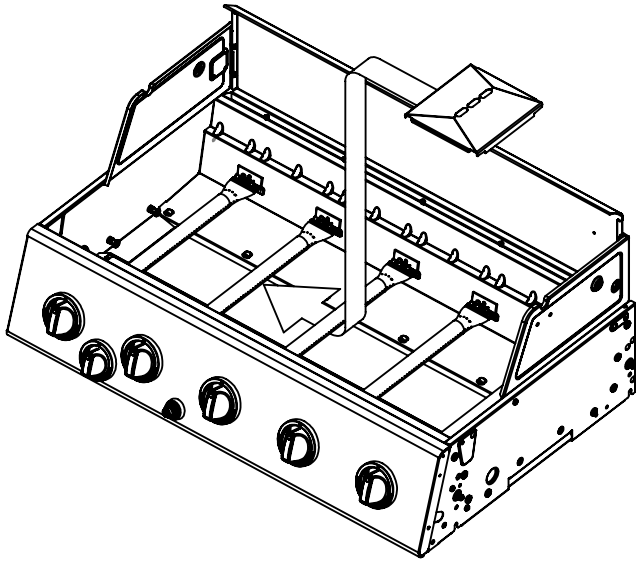
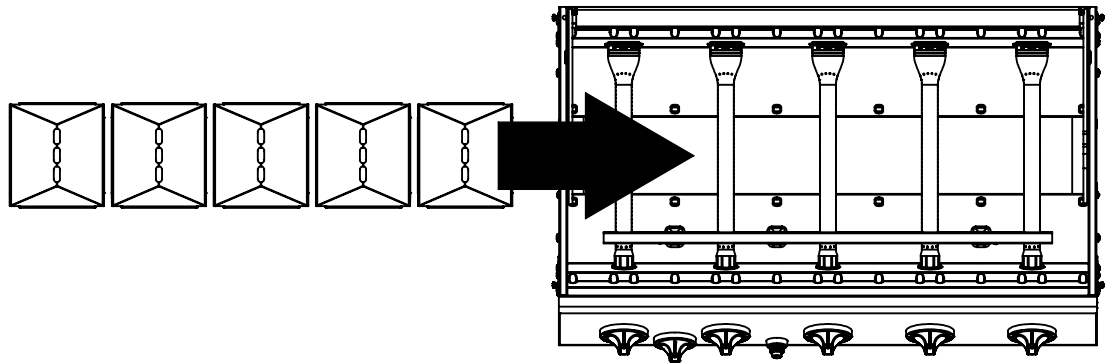

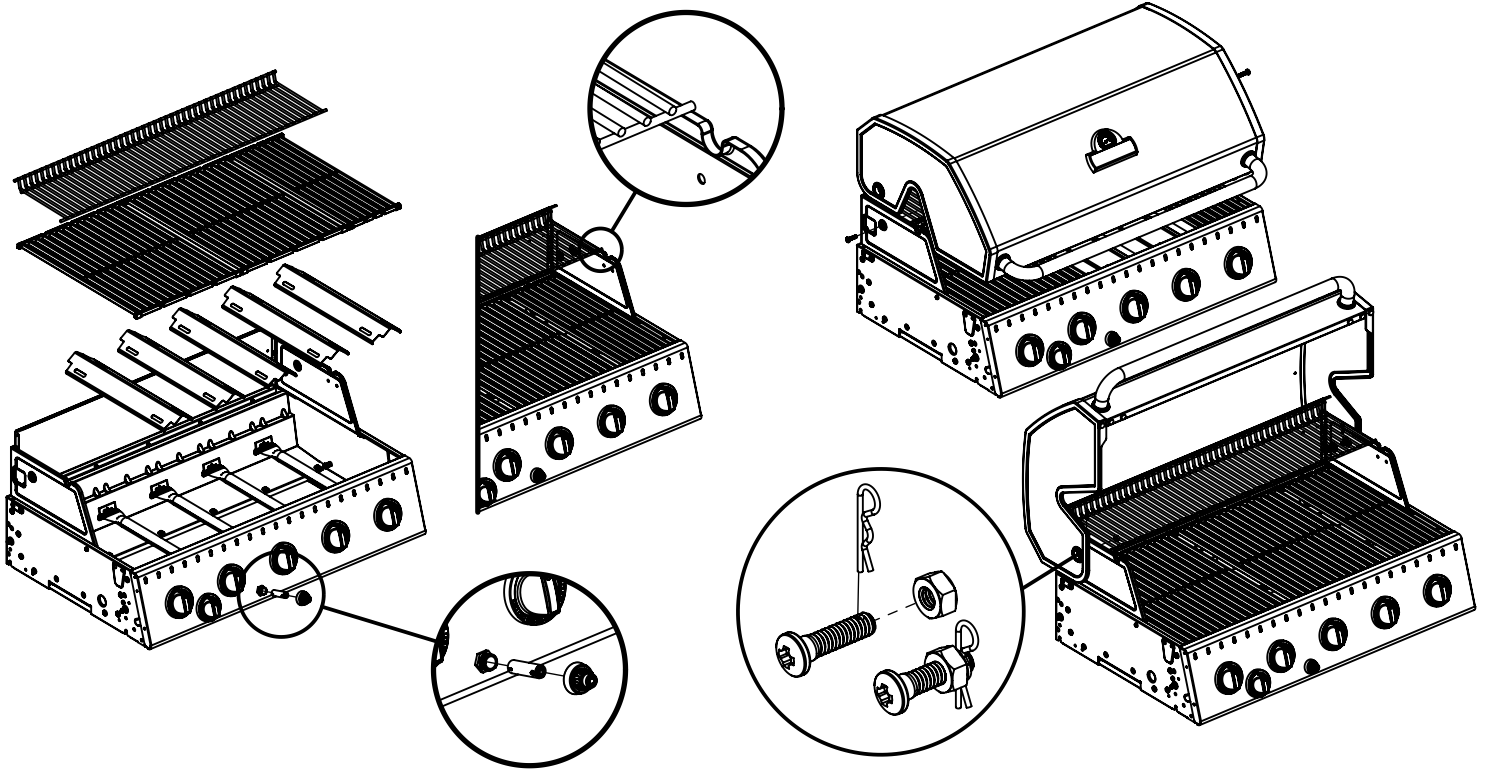
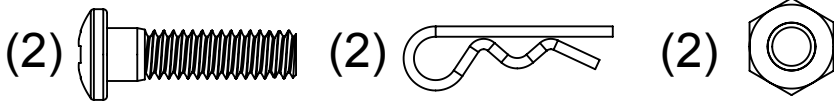

11

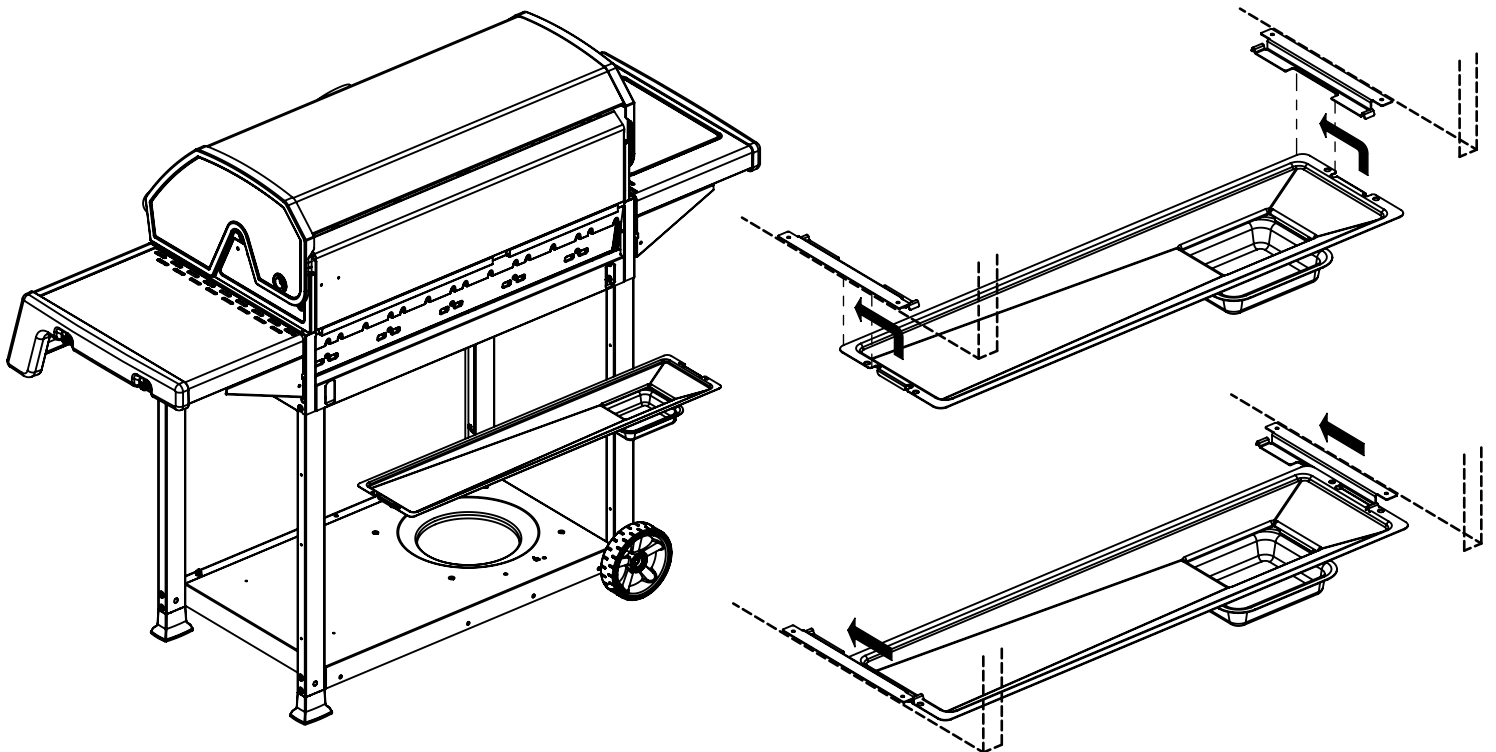

12

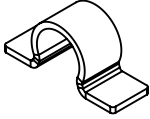

12

(2)  (2) 

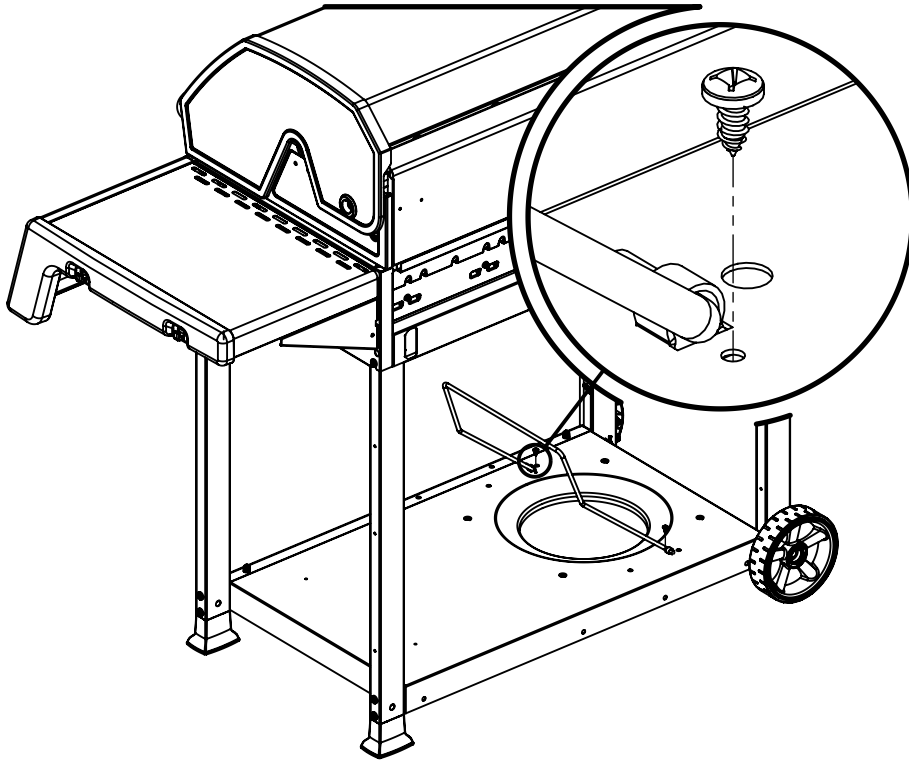

13

