

This Owner's Manual is provided and hosted by [Appliance Factory Parts](#).



Sterling 5123-82 Owner's Manual

[Shop genuine replacement parts for Sterling 5123-82](#)



[Find Your Sterling Grill Parts - Select From 509 Models](#)

----- Manual continues below part list -----

Available Replacement Parts for Sterling 5123-82

18013	LID HEAT INDICATOR - LARGE - SS
S21233	HITCH PIN CLIP +
Y-12860	SCREW-THCP 1/4-20 X 1-TY-C A04
Y-11793	NUT HEX 1/4 20 JS500 +
Y-12646	SCREW PHCP SHL.8X1/2 TY-AB +
Y-12835	SCREW-PHCP 6-32X1/4 TY-F JS500
Y-29307	NUT HEX #10-24 JS500
S21362	REAR BURNER SPRING
Y-12855	SCREW PHCP 1/4-20X3/8UNC-2A + A04 #A
S21124	SCREW PHCP #8 X 12 +
10390-E10	BURNER SIDE 10BTU W/ELEC #8 +
Y-29304	SCREW PHCP #10 24x3/8
Y-11560	BOLT PHCP 1/4 20x1-1/2 TYC +
S21125	SCREW 8 X 3/8 PAN HEAD
S15236	ROTISSERIE MOTOR AC 120V
S15263	ROTISSERIE BUSHING
S15299	WASHER COUNTERWEIGHT ROTIS
S15270	ROTISSERIE COUNTERWEIGHT ASSY
S15271	ROTISSERIE HANDLE +
S35094	SCREW #10-24 X 5/8
S21061	WING NUT STAMPED 10-24
10342-246	IGNITOR ELECTRONIC TRIPLE +
Y-11231	LID BUMPER ROUND BLK
Y-12223	MAGNET SNAP IN - DOOR
Y-12222	MAGNET - DOOR
23000-271	SIDE BURNER BODY BASE
22009-901	GREASE PAN FORMED +
S21084	SCREW HEX WASHER HEAD #14x3/4
10081-S50	NAMEPLATE STERLING +
10342-E13	ELECTRODE W/WIRE

10342-T18	WIRE ELECTRODE S/B 600 +
S15257	SPIT ROD ROTISSERIE 33 INCH
24006-12A	HANDLE LID ASSY 625
S15260	SPIT ROD ROTISSERIE 750 45 INCH
27056-901	GREASE TRAY PORC FORMED 625
10240-19	DOOR PIN BOTTOM
Y-12124	DOOR PIN CAP BOTTOM
27055-901	GREASE TRAY PORC FORMED 440 +
21475-138	DOOR HANDLE RESIN
52045-92	FIREBOX 440 HEAT SHIELD REAR
52315-151	FIREBOX 440 HOOD PANEL PORC
52904-144	BURNER ASSY MAIN SINGLE TUBE + LP
18431	FLAV-R-WAVE - BARON - SS
52007-181	COOKING GRID 550 PORC BLK +
21039-911	CASTER BRACKET BLACK
23000-251	COVER SIDE BURNER BLACK +
53139-98	GRID PORCELAIN S/B RAW *
10240-23	LID PIN 1/4-20
Y-12127	DOOR CLIP UPPER
Y-29310	SCREW #10-24 3/4 TRUSS QU
52046-92	FIREBOX 550 HEAT SHIELD 5V AB
52316-151	FIREBOX 550 HOOD PANEL PORC
52006-991	WARMING RACK 550 PORC +
21036-991	GREASE RAIL 550/625
27906-354	REAR BURNER TUBULAR W/DEFLECTOR
10342-251	Igniter, 5 port, aftermarket
10892-23	CASTER RUBBER 3 INCH W/PLATE
52015-903	COLLECTOR BOX ASSEMBLY 440
52016-903	COLLECTOR BOX ASSEMBLY 625
18010	LID HEAT INDICATOR - SMALL - SS
50502	ROTISSERIE - HEAVY DUTY FORKS - 2 PC - C
24009-936	HANDLE RING
10342-247	IGNITOR ELECTRONIC +

10472-K431	CONTRL KNOB RESIN LRG BLCK W/SS BA STRIP
22001-168	CONTROL KNOB BEZEL SML
22002-268	CONTROL KNOB BEZEL LARGE
24005-12AB	LID-HANDLE BENT,
52005-991	WARMING RACK 440 PORC
21035-991	GREASE RAIL 440/500 SABLE BLK
27905-354	BURNER TUBE REAR 500 W/WINDSHIELD
53001-011A	SHELF ASSEMBLY 330/440 RHS + SS FASCIA
27249-904	GREASE SHIELD MODULAR, 6.5 x 6



REDI-BILT BARBECUES



STERLING® 6

- 5023-62/82
- 5023-63/83
- 5023-66/86
- 5123-82
- 5123-83
- 5123-86



STERLING® 6

- 5133-82
- 5133-83
- 5133-86



SINCE 1906

MANUFACTURING COMPANY

1000 EAST MARKET STREET
HUNTINGTON, INDIANA, 46750, USA

20084-E90EU REVA 02/11

1

(20)

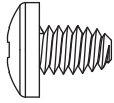

(4)

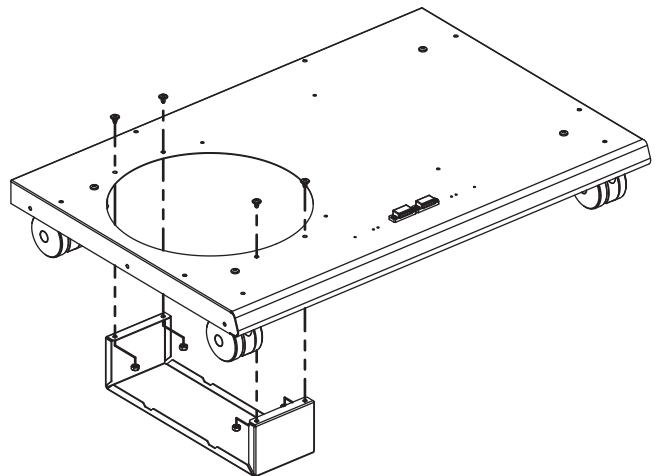
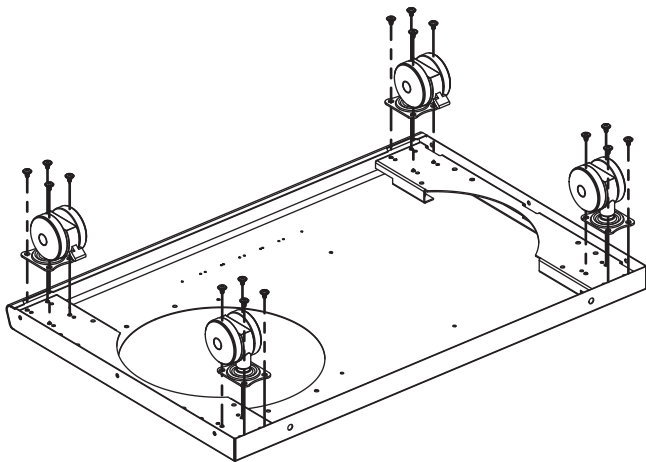
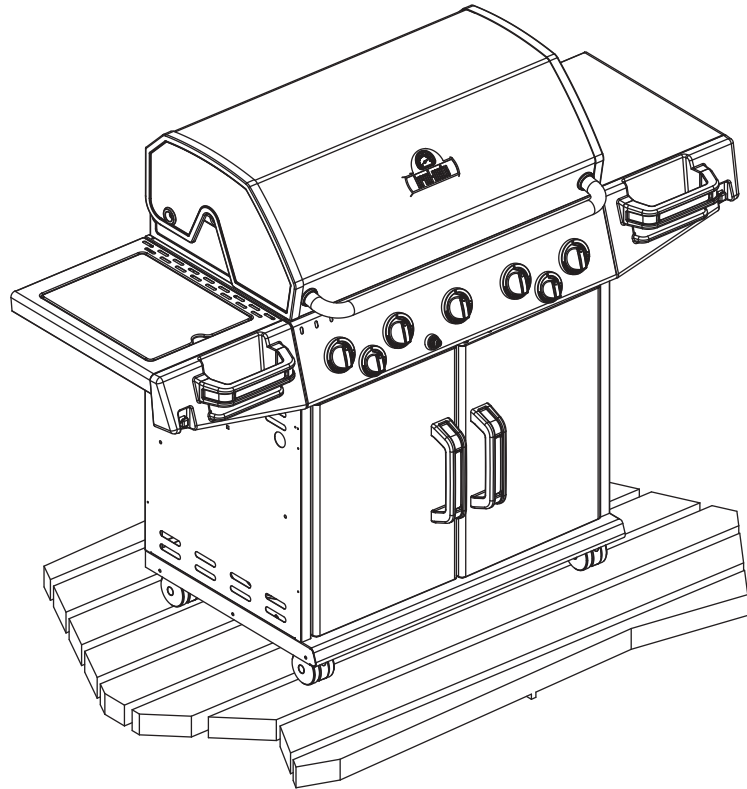

2

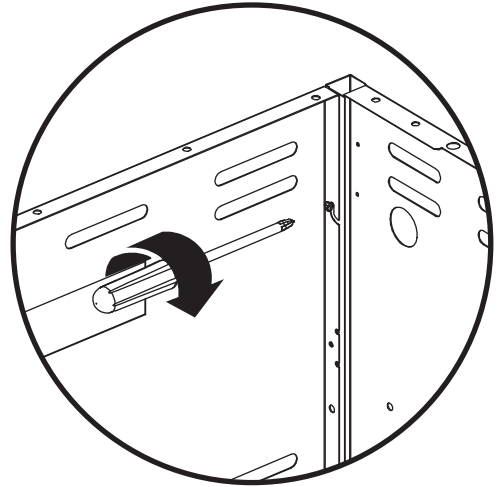
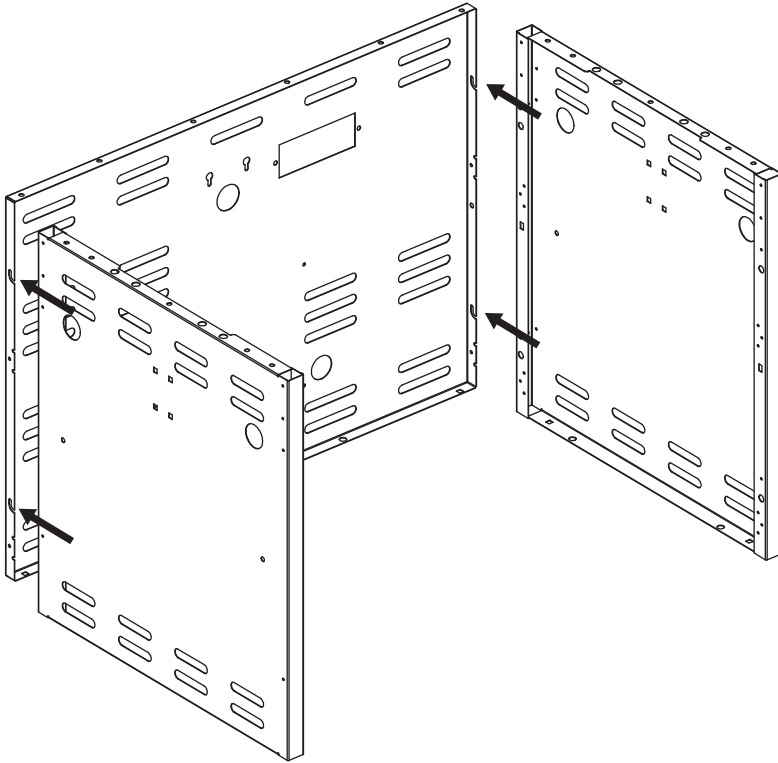

3

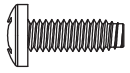
(4) 

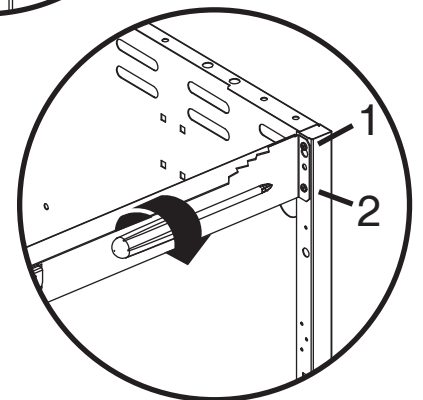
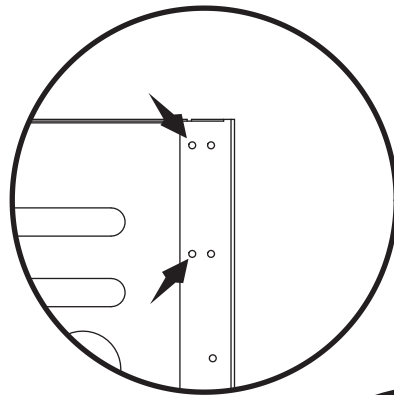
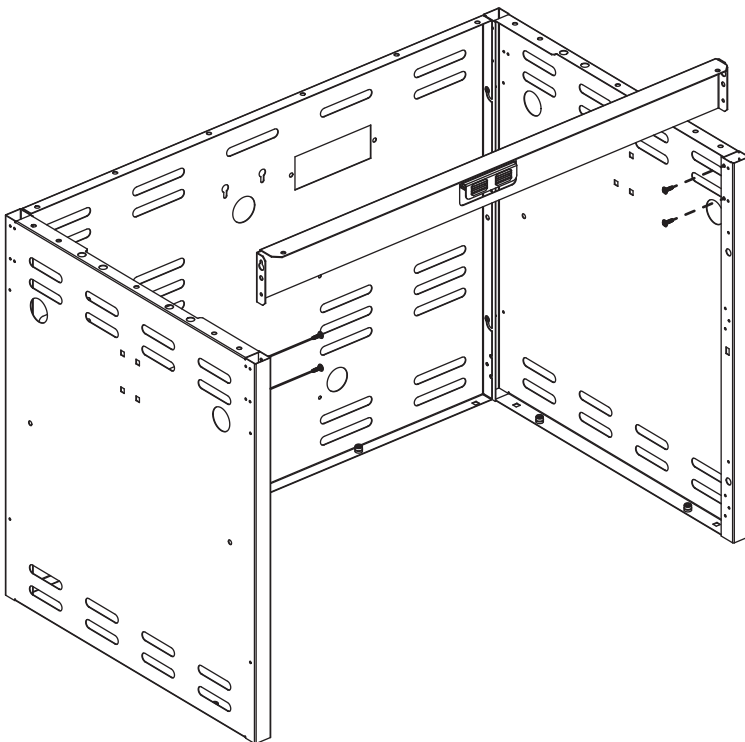

4

(4)

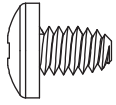

(2)

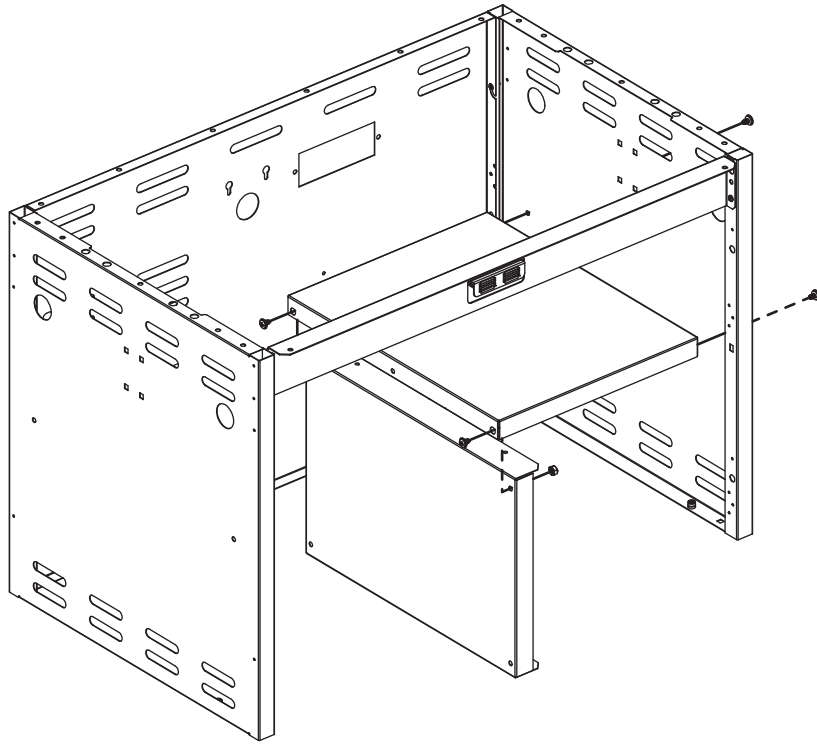

5133-82
5133-83
5133-86

5

(6)

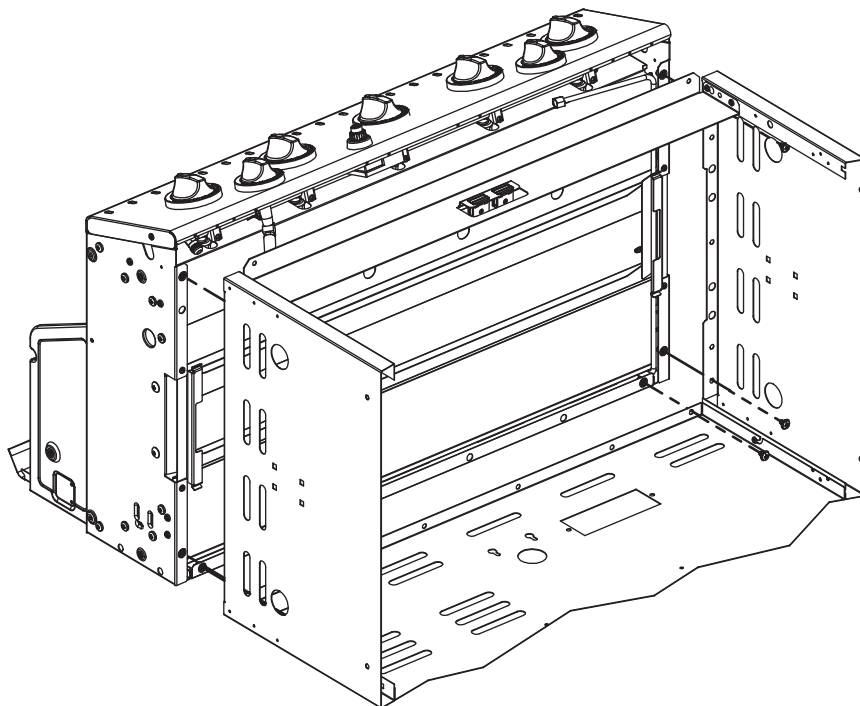
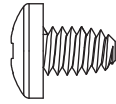

6

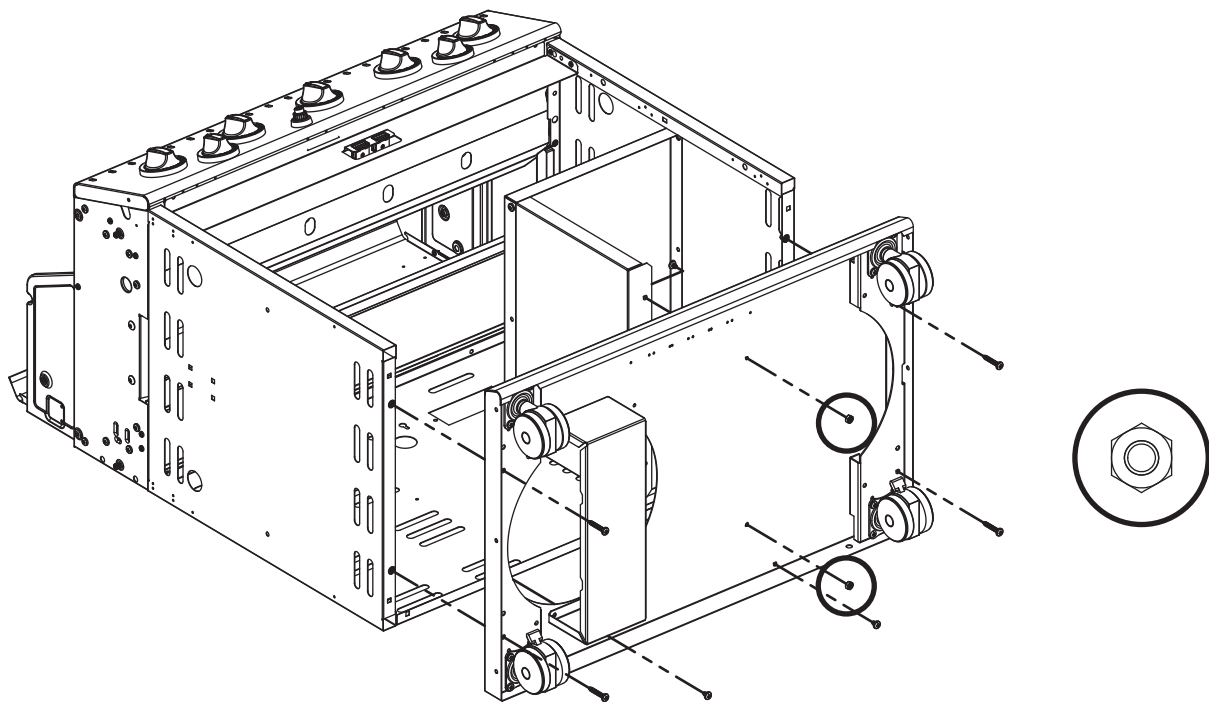
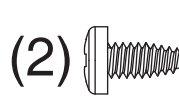
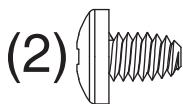
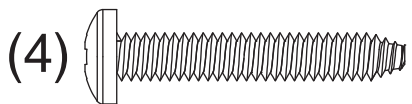

7

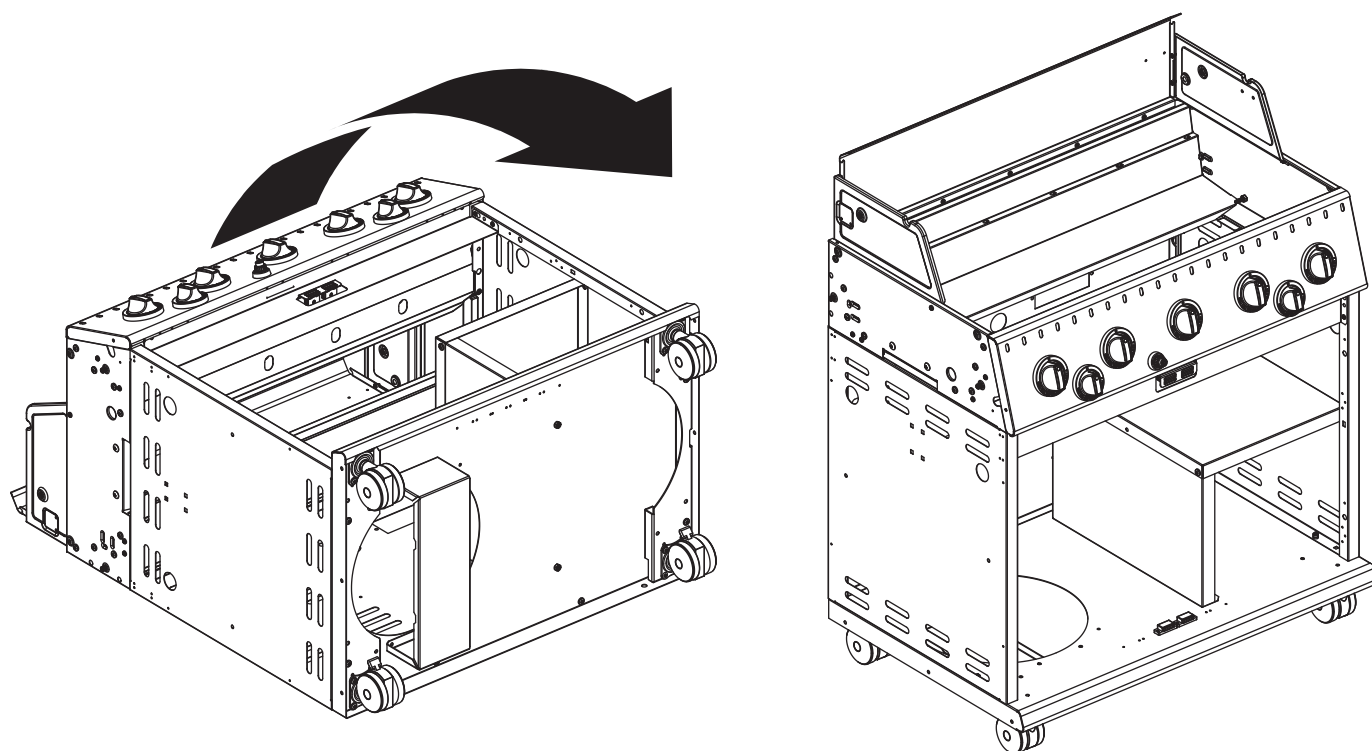

8

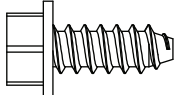
(4) 

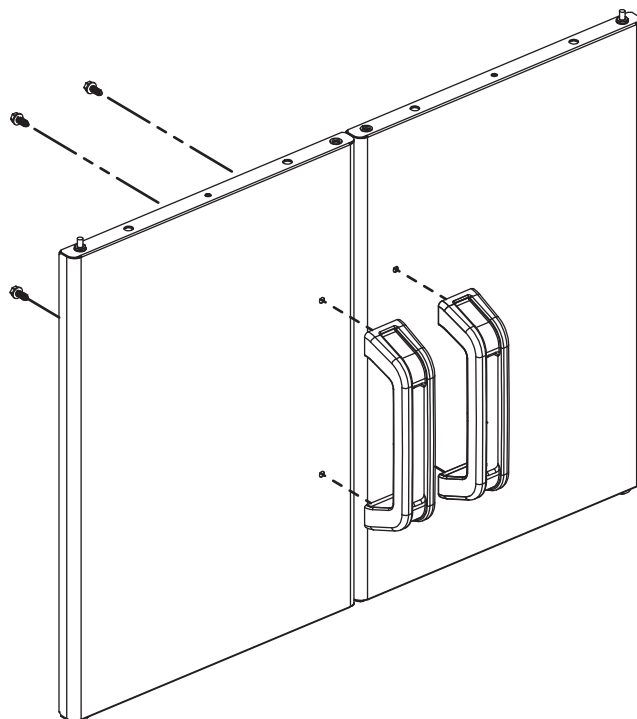

9

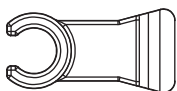
(2) 

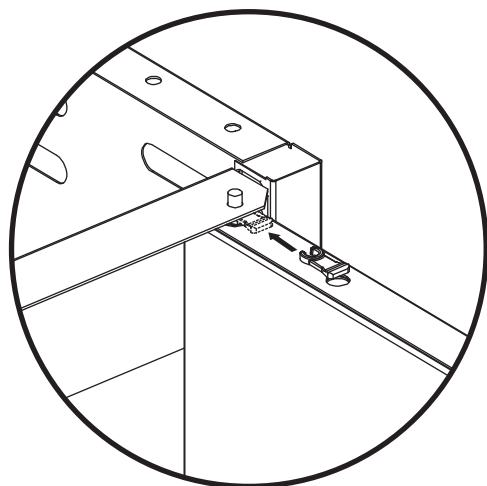
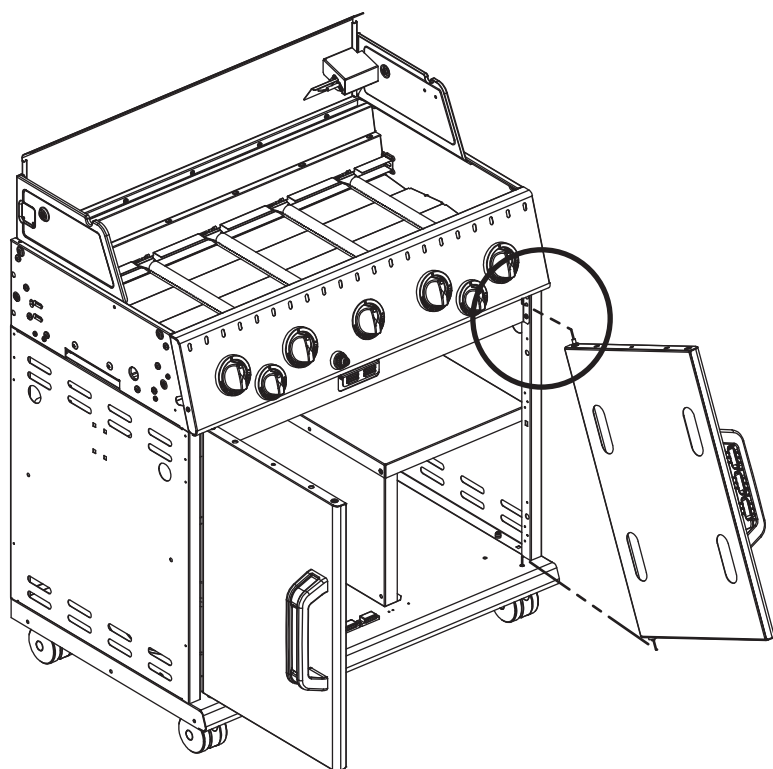

10

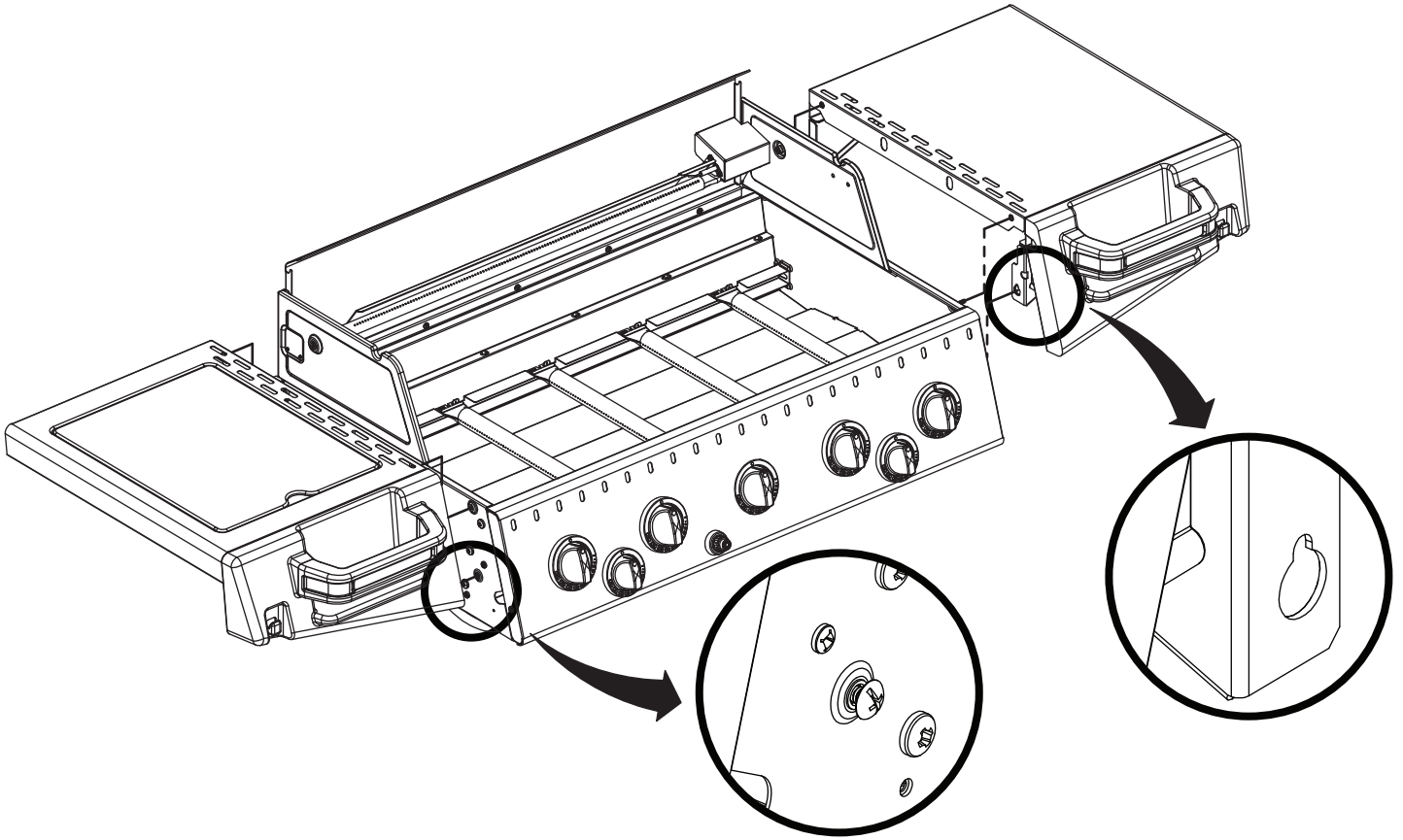

11

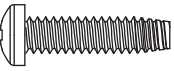
(4) 

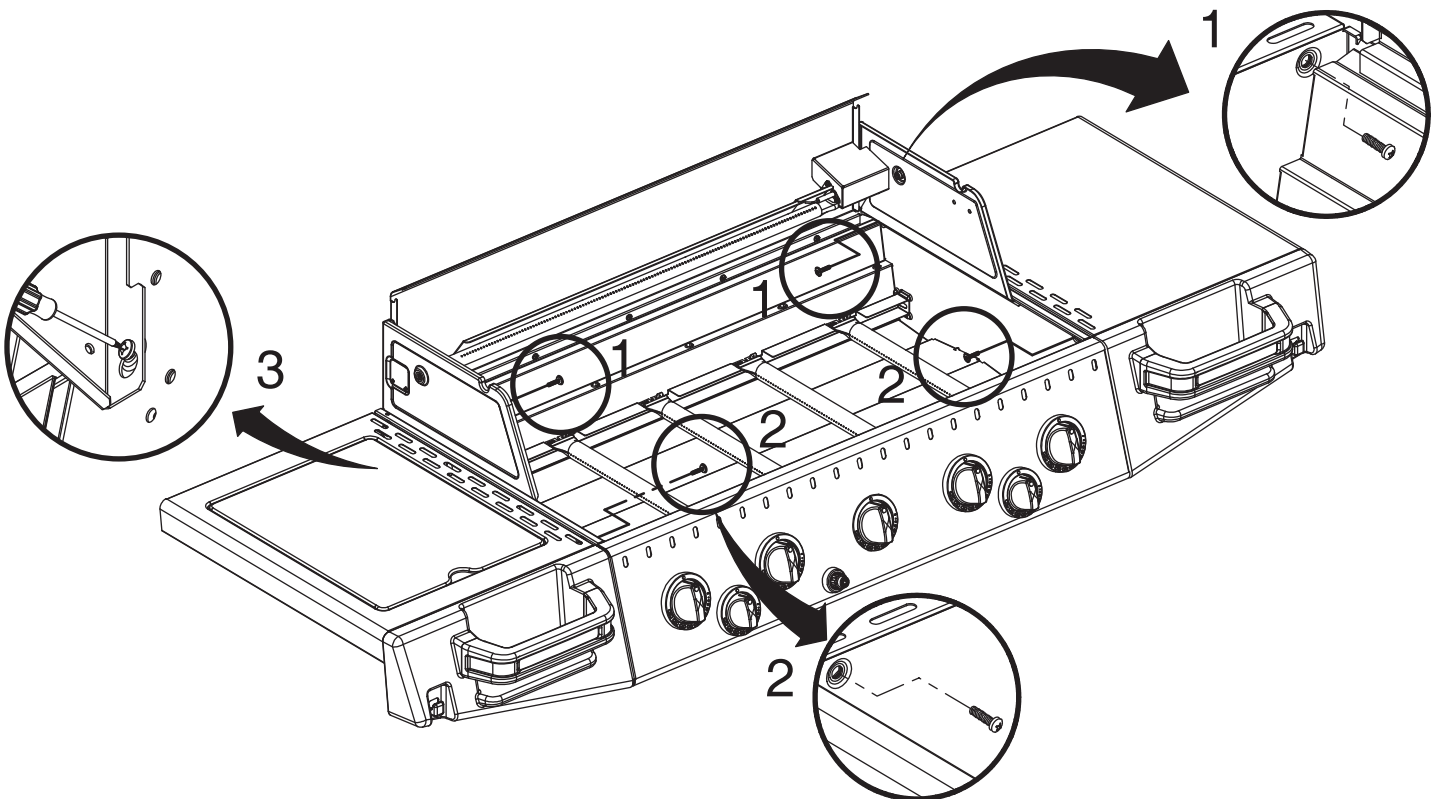

12

(1)

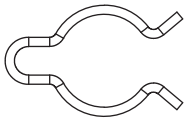

1

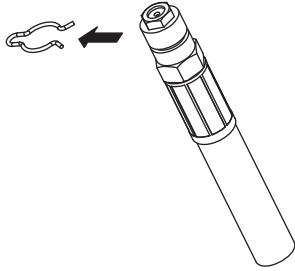

2

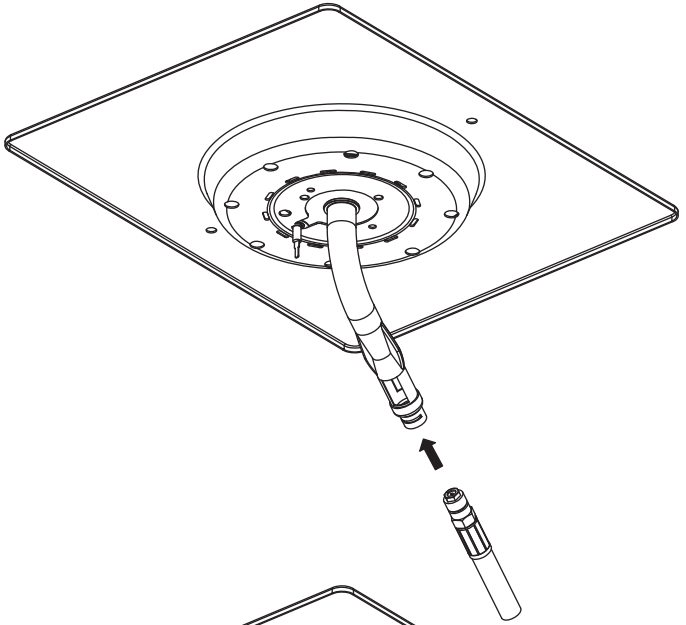

3

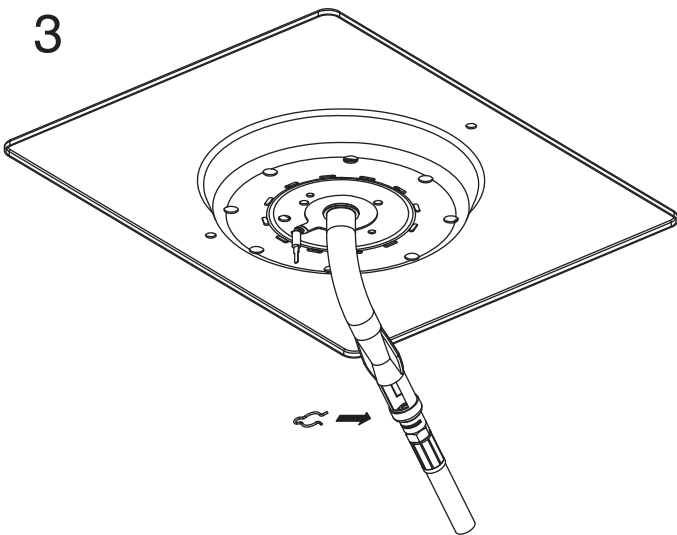

4

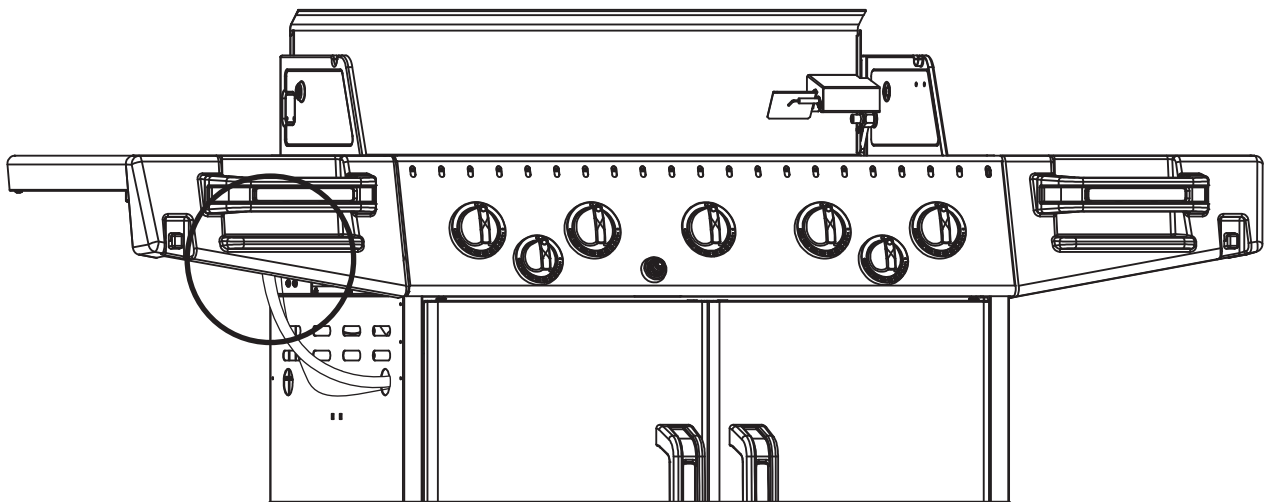
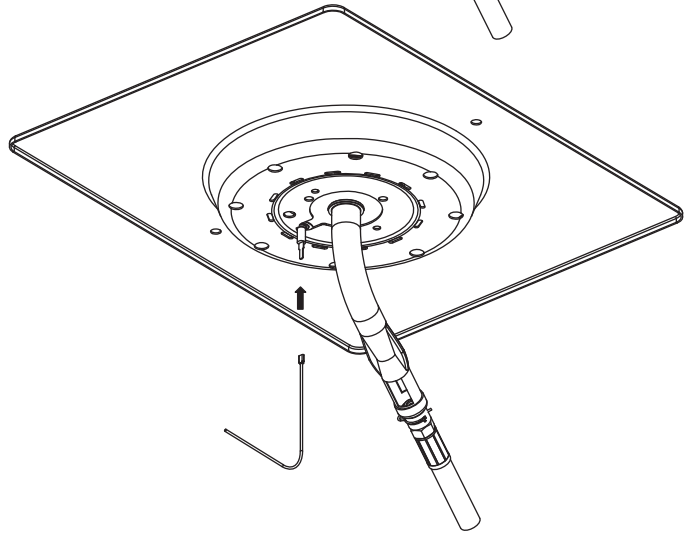

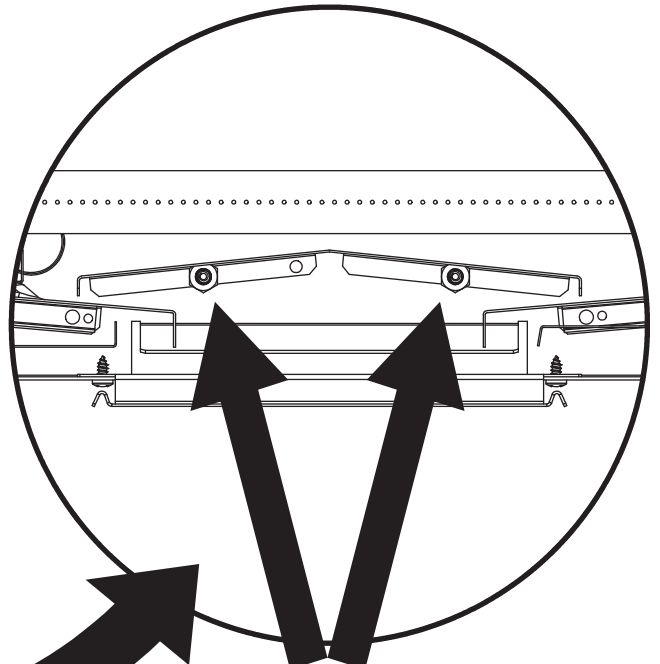
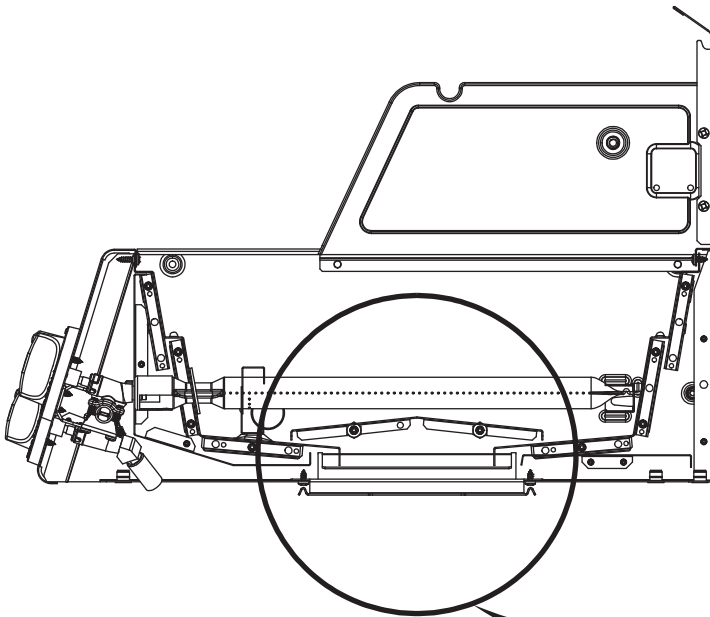
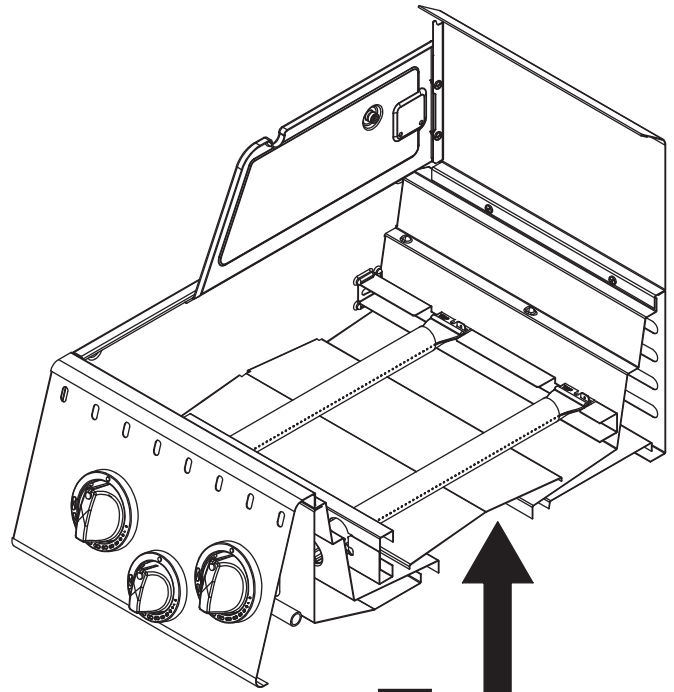
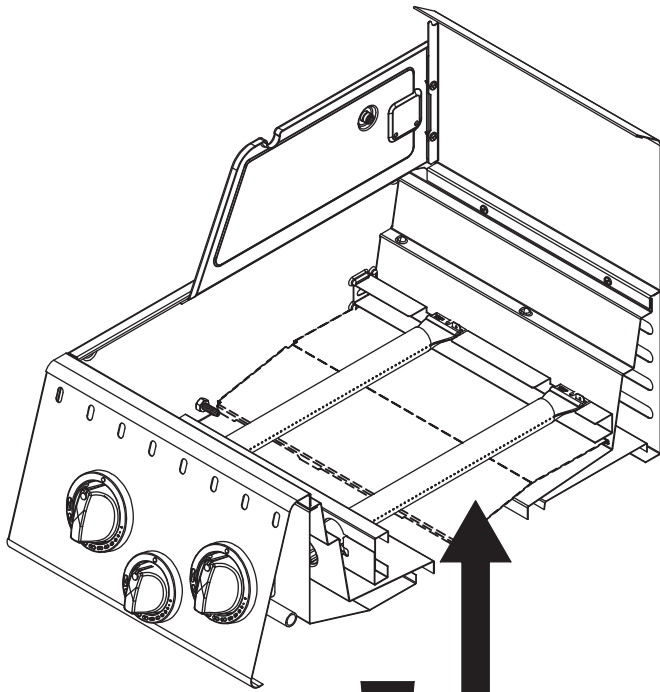

14

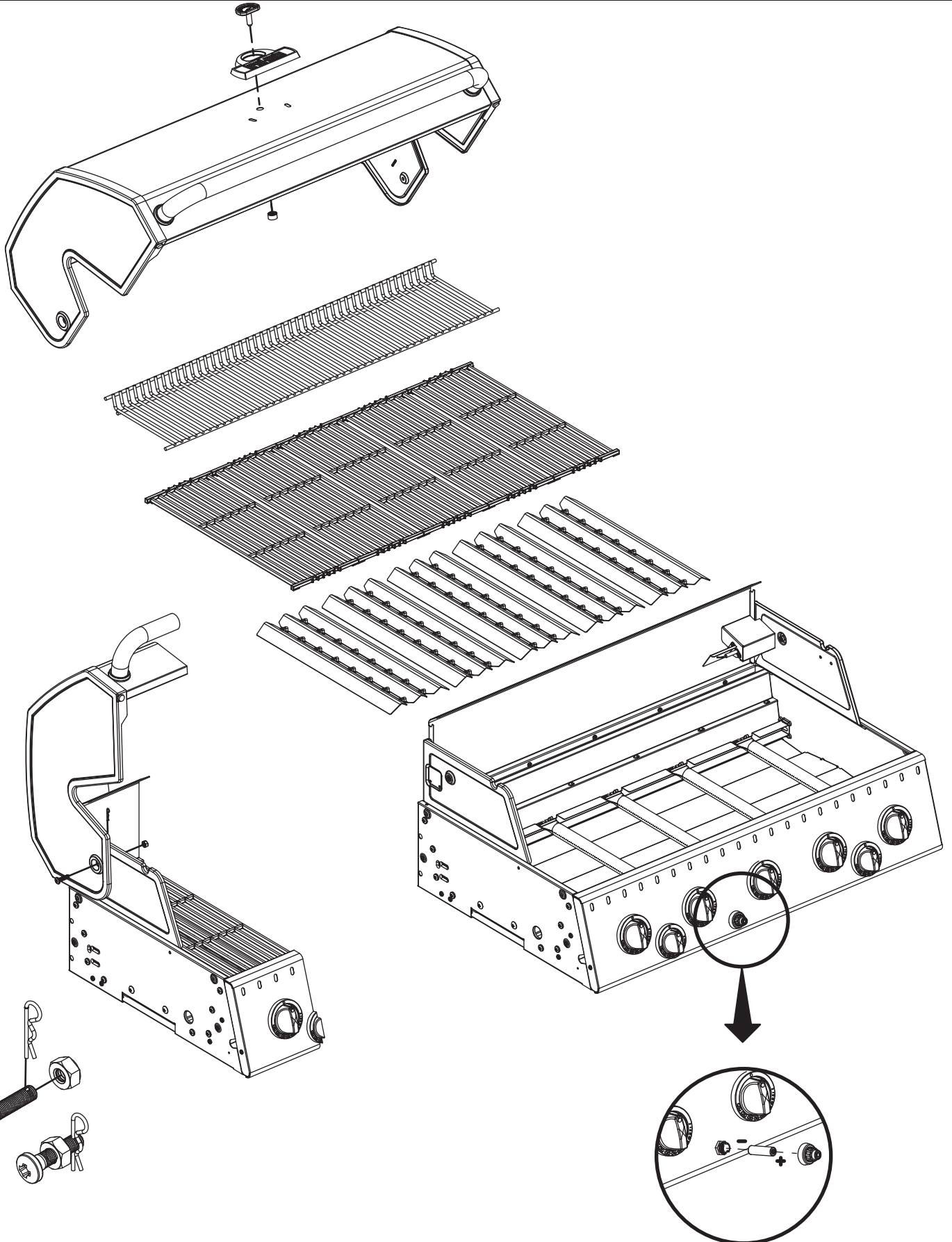
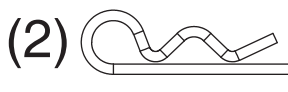
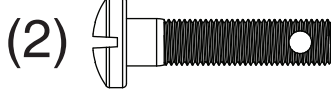

15

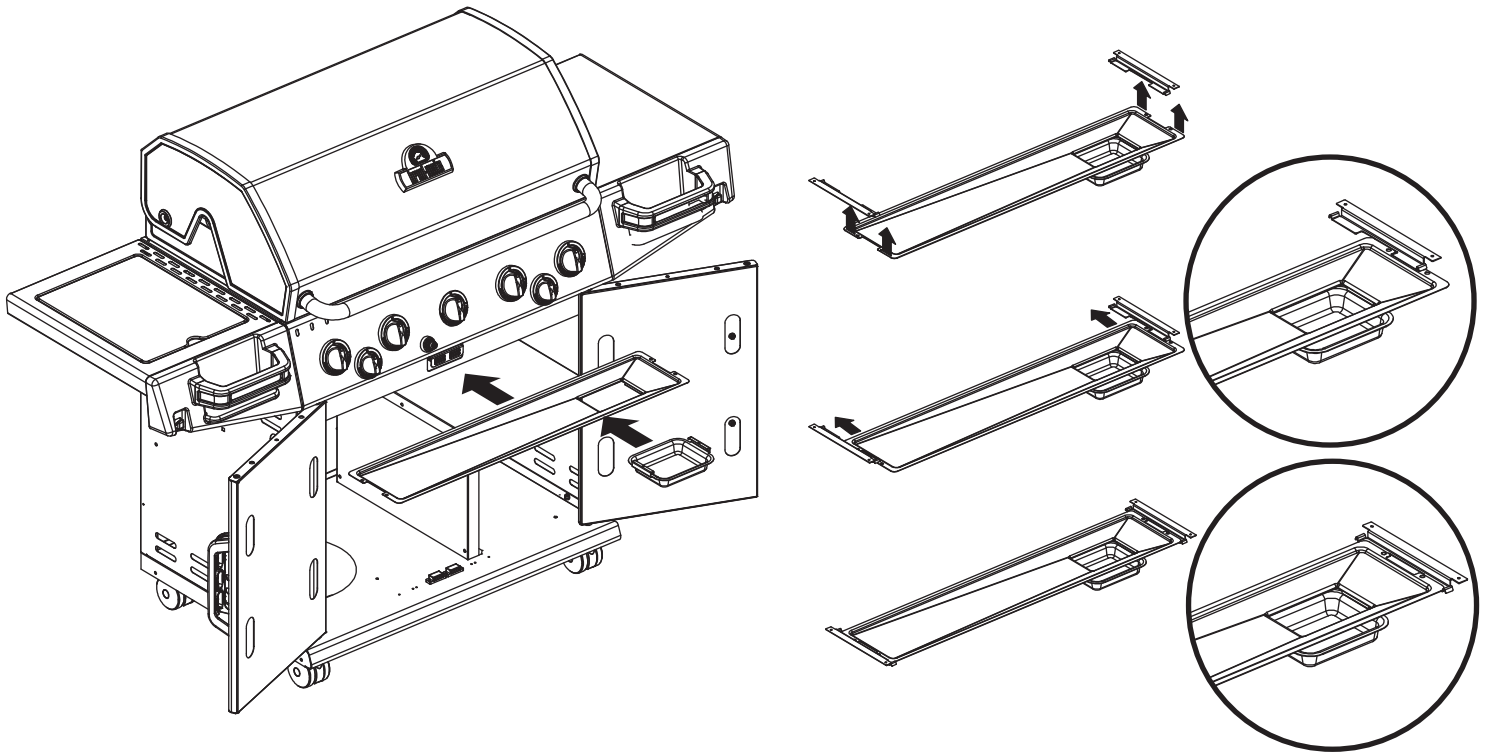

16

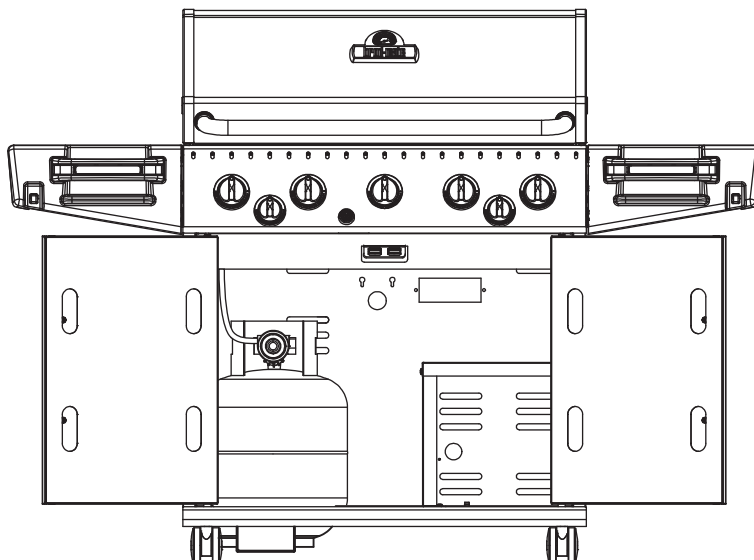

17

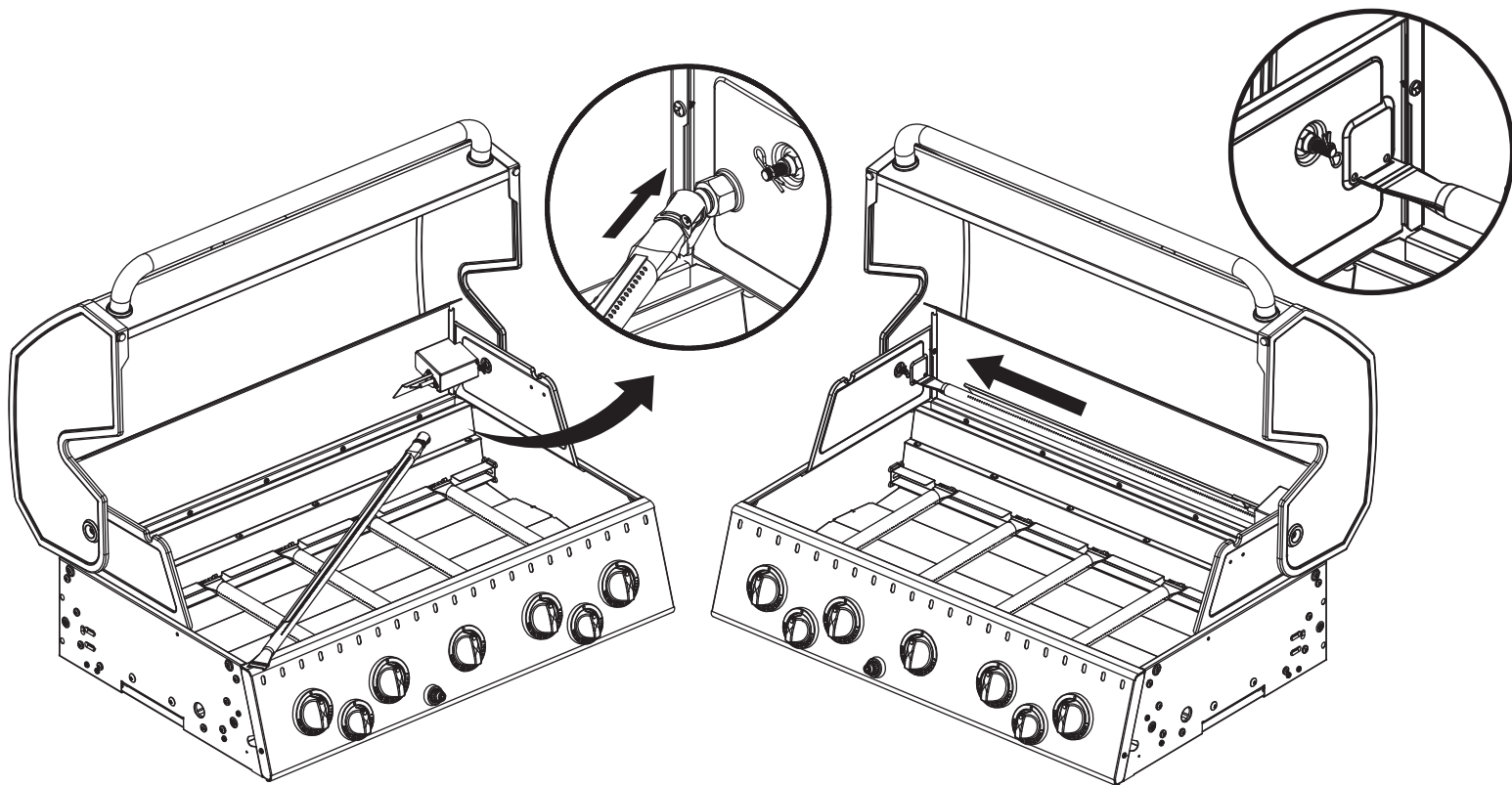

18

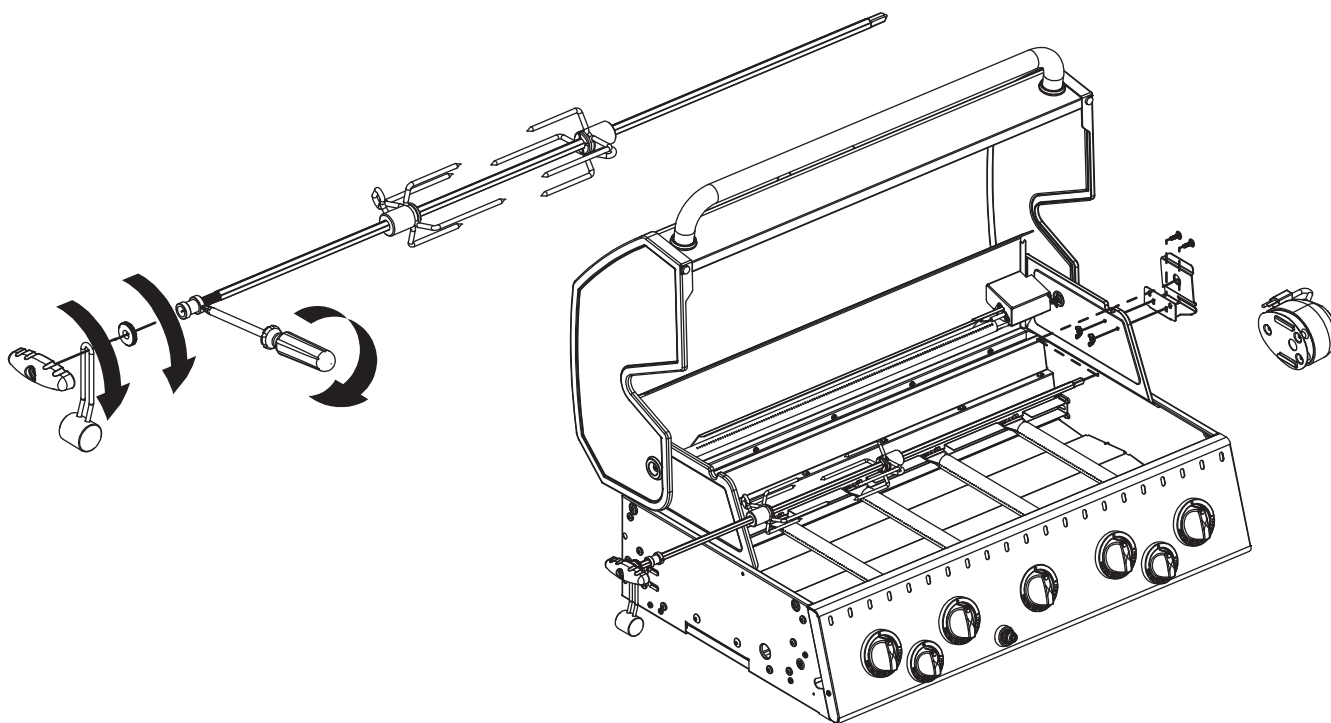
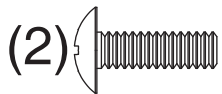

KEY #	ITEM #	5023-62	5023-63	5023-66	5023-82	5023-83	5023-86	5123-82	5123-83	5123-86	5133-82	5133-83	5133-86
1	56104-33	1	1	1	1	1	1	1	1	1	1	1	1
2	56104-31	1	1	1	1	1	1	1	1	1	1	1	1
3	56316-304	-	-	-	-	-	-	-	-	-	1	1	1
	56315-304	-	-	-	-	-	-	1	1	1	-	-	-
	56315-301	1	1	1	1	1	1	-	-	-	-	-	-
4	56246-30	-	-	-	-	-	-	-	-	-	1	1	1
	56245-30	1	1	1	1	1	1	1	1	1	-	-	-
5	24006-12A	-	-	-	-	-	-	-	-	-	1	1	1
	24005-12A	1	1	1	1	1	1	1	1	1	-	-	-
6	24009-936	2	2	2	2	2	2	2	2	2	2	2	2
8	10081-S60	-	-	-	-	-	-	-	-	-	1	1	1
	10081-S50	1	1	1	1	1	1	1	1	1	-	-	-
9	10571-6	-	-	-	-	-	-	-	-	-	1	1	1
	10571-5	1	1	1	1	1	1	1	1	1	-	-	-
11	52114-131	1	1	1	1	1	1	1	1	1	1	1	1
12	52114-111	1	1	1	1	1	1	1	1	1	1	1	1
13	52124-131	1	1	1	1	1	1	1	1	1	1	1	1
14	52124-111	1	1	1	1	1	1	1	1	1	1	1	1
15	52206-111	-	-	-	-	-	-	-	-	-	1	1	1
	52205-111	1	1	1	1	1	1	1	1	1	-	-	-
16	52206-121	-	-	-	-	-	-	-	-	-	1	1	1
	52205-121	1	1	1	1	1	1	1	1	1	-	-	-
17	27246-904	-	-	-	-	-	-	-	-	-	1	1	1
	27245-904	1	1	1	1	1	1	1	1	1	-	-	-
18	52046-91	-	-	-	-	-	-	-	-	-	1	1	1
	52045-91	1	1	1	1	1	1	1	1	1	-	-	-
19	52046-92	-	-	-	-	-	-	-	-	-	1	1	1
	52045-92	1	1	1	1	1	1	1	1	1	-	-	-
20	57236-024	-	-	-	-	-	-	-	-	-	1	1	1
	57235-024	1	1	1	1	1	1	1	1	1	-	-	-
21	S21232	4	4	4	4	4	4	4	4	4	5	5	5
22	52306-121	-	-	-	-	-	-	-	-	-	1	1	1
	52305-121	1	1	1	1	1	1	1	1	1	-	-	-
23	52316-151	-	-	-	-	-	-	-	-	-	1	1	1
	52315-151	1	1	1	1	1	1	1	1	1	-	-	-
25	52904-144	4	4	4	4	4	4	4	4	4	5	5	5
26	52226-014	-	-	-	-	-	-	-	-	-	1	1	1
	52225-014	1	1	1	1	1	1	1	1	1	-	-	-
27	52216-014	-	-	-	-	-	-	-	-	-	1	1	1
	52215-014	1	1	1	1	1	1	1	1	1	-	-	-
28	52016-304	-	-	-	-	-	-	-	-	-	1	1	1
	52015-304	-	-	-	1	1	1	1	1	1	-	-	-
	52015-244	1	1	1	-	-	-	-	-	-	-	-	-
29	59006-072	-	-	-	-	-	-	-	-	-	1	-	-
	59006-075	-	-	-	-	-	-	-	-	-	-	1	-
	59006-076	-	-	-	-	-	-	-	-	-	-	-	1
	59005-072	-	-	-	1	-	-	1	-	-	-	-	-
	59005-075	-	-	-	-	1	-	-	1	-	-	-	-
	59005-076	-	-	-	-	-	1	-	-	1	-	-	-
	59005-032	1	-	-	-	-	-	-	-	-	-	-	-
	59005-035	-	1	-	-	-	-	-	-	-	-	-	-
	59005-036	-	-	1	-	-	-	-	-	-	-	-	-
30	S13470-066	1	-	-	1	-	-	1	-	-	1	-	-
	S13470-079	-	1	-	-	1	-	-	1	-	-	1	-
	S13470-109	-	-	1	-	-	1	-	-	1	-	-	1
32	27906-35	-	-	-	-	-	-	-	-	-	1	1	1
	27905-35	-	-	-	1	1	1	1	1	1	-	-	-
33	50809-957	-	-	-	1	1	1	1	1	1	1	1	1
34	22339-304	-	-	-	1	1	1	1	1	1	1	1	1
35	22949-504	-	-	-	1	1	1	1	1	1	1	1	1
36	10342-T17	-	-	-	1	1	1	1	1	1	1	1	1
38	22002-268	4	4	4	4	4	4	4	4	4	5	5	5
39	22001-168	1	1	1	2	2	2	2	2	2	2	2	2
40	10472-K431	4	4	4	4	4	4	4	4	4	5	5	5
41	50479-K231	1	1	1	2	2	2	2	2	2	2	2	2
42	10342-251	-	-	-	-	-	-	-	-	-	1	1	1
	10342-247	-	-	-	1	1	1	1	1	1	-	-	-
	10342-246	1	1	1	-	-	-	-	-	-	-	-	-
43	10342-E13	2	2	2	2	2	2	2	2	2	3	3	3
44	52209-404	4	4	4	4	4	4	4	4	4	5	5	5
45	52007-181	4	4	4	4	4	4	4	4	4	5	5	5
46	52006-991	-	-	-	-	-	-	-	-	-	1	1	1

