

This Owner's Manual is provided and hosted by [Appliance Factory Parts](#).



# Sterling 5123-83 Owner's Manual

[Shop genuine replacement parts for Sterling 5123-83](#)



[Find Your Sterling Grill Parts - Select From 509 Models](#)

----- Manual continues below part list -----

## Available Replacement Parts for Sterling 5123-83

<a href="#">18013</a>	LID HEAT INDICATOR - LARGE - SS
<a href="#">S21233</a>	HITCH PIN CLIP +
<a href="#">Y-12860</a>	SCREW-THCP 1/4-20 X 1-TY-C A04
<a href="#">Y-11793</a>	NUT HEX 1/4 20 JS500 +
<a href="#">Y-12646</a>	SCREW PHCP SHL.8X1/2 TY-AB +
<a href="#">Y-12835</a>	SCREW-PHCP 6-32X1/4 TY-F JS500
<a href="#">Y-29307</a>	NUT HEX #10-24 JS500
<a href="#">S21362</a>	REAR BURNER SPRING
<a href="#">Y-12855</a>	SCREW PHCP 1/4-20X3/8UNC-2A + A04 #A
<a href="#">S21124</a>	SCREW PHCP #8 X 12 +
<a href="#">10390-E10</a>	BURNER SIDE 10BTU W/ELEC #8 +
<a href="#">Y-29304</a>	SCREW PHCP #10 24x3/8
<a href="#">Y-11560</a>	BOLT PHCP 1/4 20x1-1/2 TYC +
<a href="#">S21125</a>	SCREW 8 X 3/8 PAN HEAD
<a href="#">S15236</a>	ROTISSERIE MOTOR AC 120V
<a href="#">S15263</a>	ROTISSERIE BUSHING
<a href="#">S15299</a>	WASHER COUNTERWEIGHT ROTIS
<a href="#">S15270</a>	ROTISSERIE COUNTERWEIGHT ASSY
<a href="#">S15271</a>	ROTISSERIE HANDLE +
<a href="#">S35094</a>	SCREW #10-24 X 5/8
<a href="#">S21061</a>	WING NUT STAMPED 10-24
<a href="#">10342-246</a>	IGNITOR ELECTRONIC TRIPLE +
<a href="#">Y-11231</a>	LID BUMPER ROUND BLK
<a href="#">Y-12223</a>	MAGNET SNAP IN - DOOR
<a href="#">Y-12222</a>	MAGNET - DOOR
<a href="#">23000-271</a>	SIDE BURNER BODY BASE
<a href="#">22009-901</a>	GREASE PAN FORMED +
<a href="#">S21084</a>	SCREW HEX WASHER HEAD #14x3/4
<a href="#">10081-S50</a>	NAMEPLATE STERLING +
<a href="#">10342-E13</a>	ELECTRODE W/WIRE

<a href="#">10342-T18</a>	WIRE ELECTRODE S/B 600 +
<a href="#">S15257</a>	SPIT ROD ROTISSERIE 33 INCH
<a href="#">24006-12A</a>	HANDLE LID ASSY 625
<a href="#">S15260</a>	SPIT ROD ROTISSERIE 750 45 INCH
<a href="#">27056-901</a>	GREASE TRAY PORC FORMED 625
<a href="#">10240-19</a>	DOOR PIN BOTTOM
<a href="#">Y-12124</a>	DOOR PIN CAP BOTTOM
<a href="#">27055-901</a>	GREASE TRAY PORC FORMED 440 +
<a href="#">21475-138</a>	DOOR HANDLE RESIN
<a href="#">52045-92</a>	FIREBOX 440 HEAT SHIELD REAR
<a href="#">52315-151</a>	FIREBOX 440 HOOD PANEL PORC
<a href="#">52904-144</a>	BURNER ASSY MAIN SINGLE TUBE + LP
<a href="#">18431</a>	FLAV-R-WAVE - BARON - SS
<a href="#">52007-181</a>	COOKING GRID 550 PORC BLK +
<a href="#">21039-911</a>	CASTER BRACKET BLACK
<a href="#">23000-251</a>	COVER SIDE BURNER BLACK +
<a href="#">53139-98</a>	GRID PORCELAIN S/B RAW *
<a href="#">10240-23</a>	LID PIN 1/4-20
<a href="#">Y-12127</a>	DOOR CLIP UPPER
<a href="#">Y-29310</a>	SCREW #10-24 3/4 TRUSS QU
<a href="#">52046-92</a>	FIREBOX 550 HEAT SHIELD 5V AB
<a href="#">52316-151</a>	FIREBOX 550 HOOD PANEL PORC
<a href="#">52006-991</a>	WARMING RACK 550 PORC +
<a href="#">21036-991</a>	GREASE RAIL 550/625
<a href="#">27906-354</a>	REAR BURNER TUBULAR W/DEFLCTOR
<a href="#">10342-251</a>	Igniter, 5 port, aftermarket
<a href="#">10892-23</a>	CASTER RUBBER 3 INCH W/PLATE
<a href="#">52015-903</a>	COLLECTOR BOX ASSEMBLY 440
<a href="#">52016-903</a>	COLLECTOR BOX ASSEMBLY 625
<a href="#">18010</a>	LID HEAT INDICATOR - SMALL - SS
<a href="#">50502</a>	ROTISSERIE - HEAVY DUTY FORKS - 2 PC - C
<a href="#">24009-936</a>	HANDLE RING
<a href="#">10342-247</a>	IGNITOR ELECTRONIC +

<a href="#">10472-K431</a>	CONTRL KNOB RESIN LRG BLCK W/SS BA STRIP
<a href="#">22001-168</a>	CONTROL KNOB BEZEL SML
<a href="#">22002-268</a>	CONTROL KNOB BEZEL LARGE
<a href="#">24005-12AB</a>	LID-HANDLE BENT,
<a href="#">52005-991</a>	WARMING RACK 440 PORC
<a href="#">21035-991</a>	GREASE RAIL 440/500 SABLE BLK
<a href="#">27905-354</a>	BURNER TUBE REAR 500 W/WINDSHIELD
<a href="#">53001-011A</a>	SHELF ASSEMBLY 330/440 RHS + SS FASCIA
<a href="#">27249-904</a>	GREASE SHIELD MODULAR, 6.5 x 6



REDI-BILT BARBECUES



**STERLING® 6**

- 5023-62/82
- 5023-63/83
- 5023-66/86
- 5123-82
- 5123-83
- 5123-86



**STERLING® 6**

- 5133-82
- 5133-83
- 5133-86



SINCE 1906

MANUFACTURING COMPANY

1000 EAST MARKET STREET  
HUNTINGTON, INDIANA, 46750, USA

20084-E90EU REVA 02/11

**1**

(20)

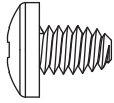

(4)

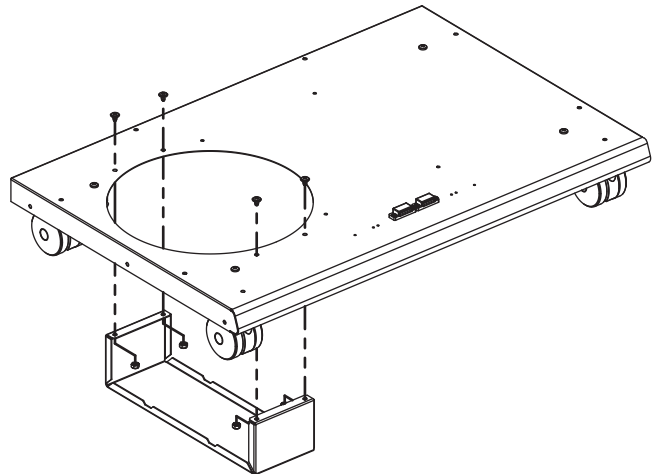
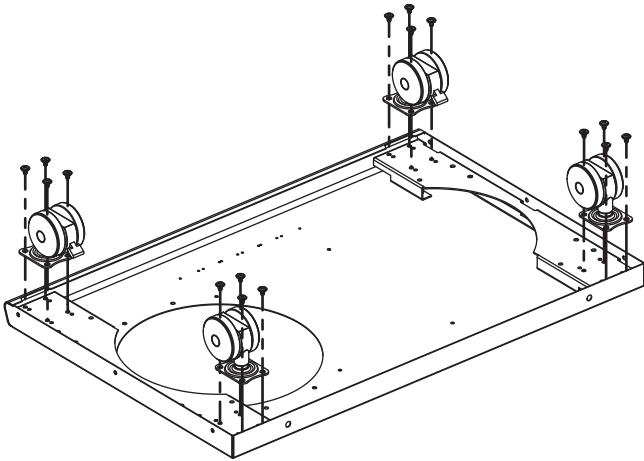
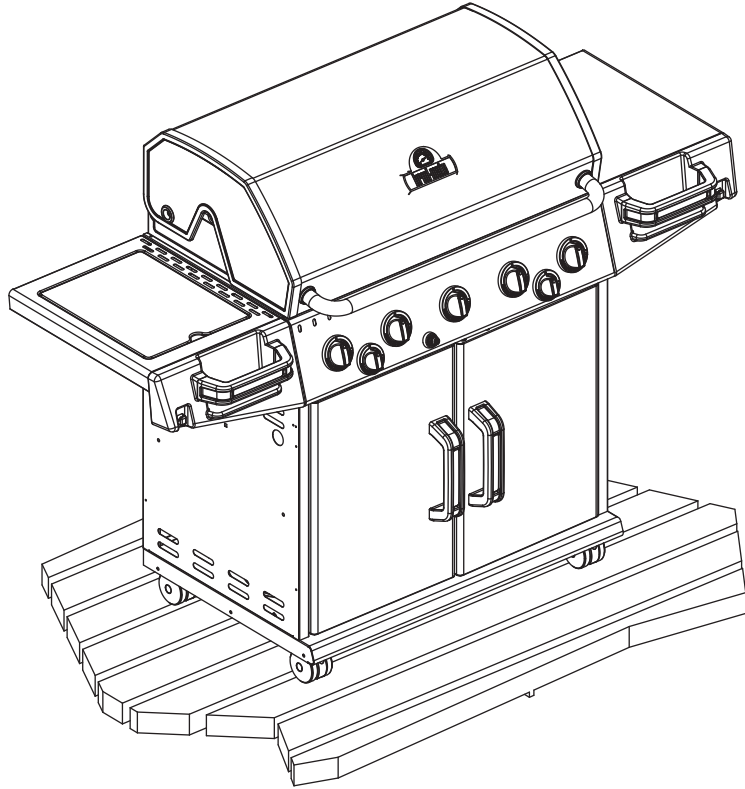

**2**

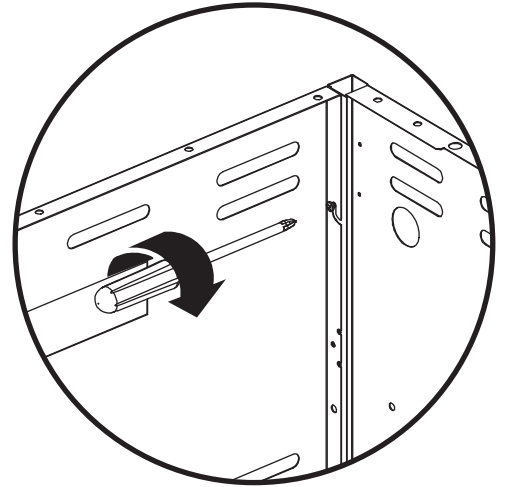
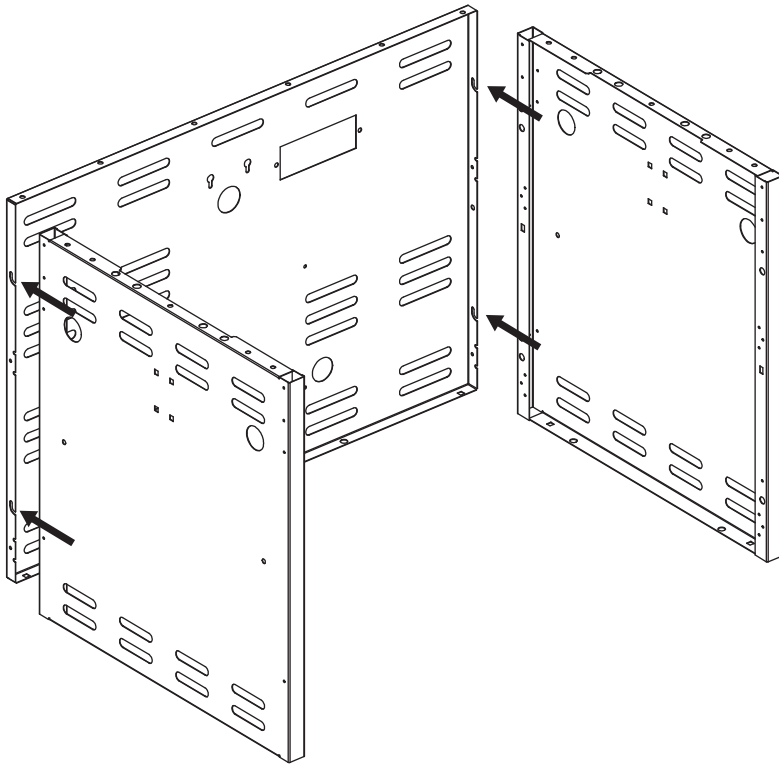

**3**

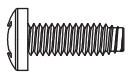
(4) 

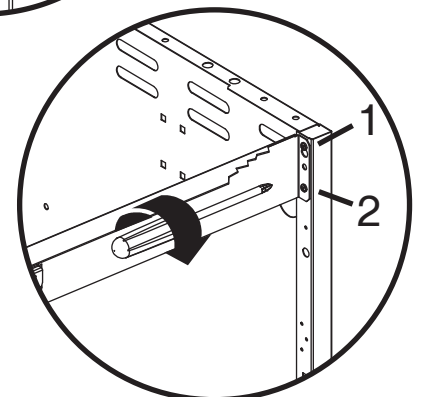
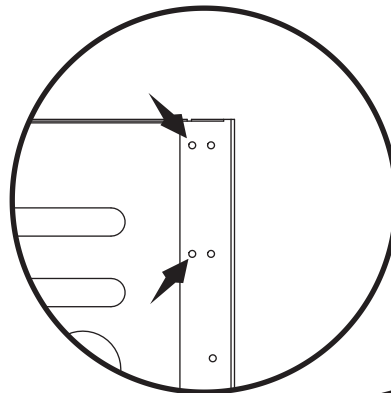
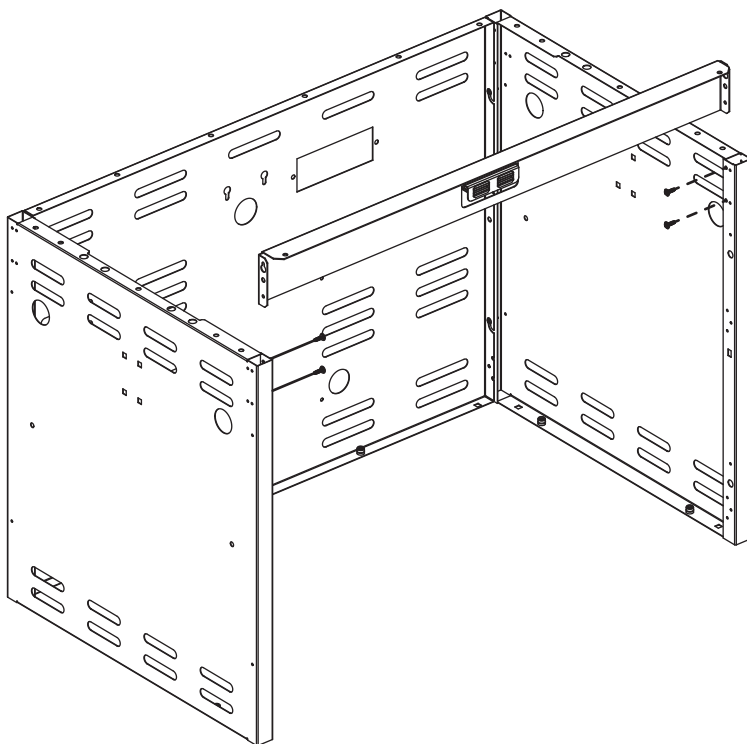

**4**

(4)

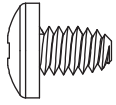

(2)

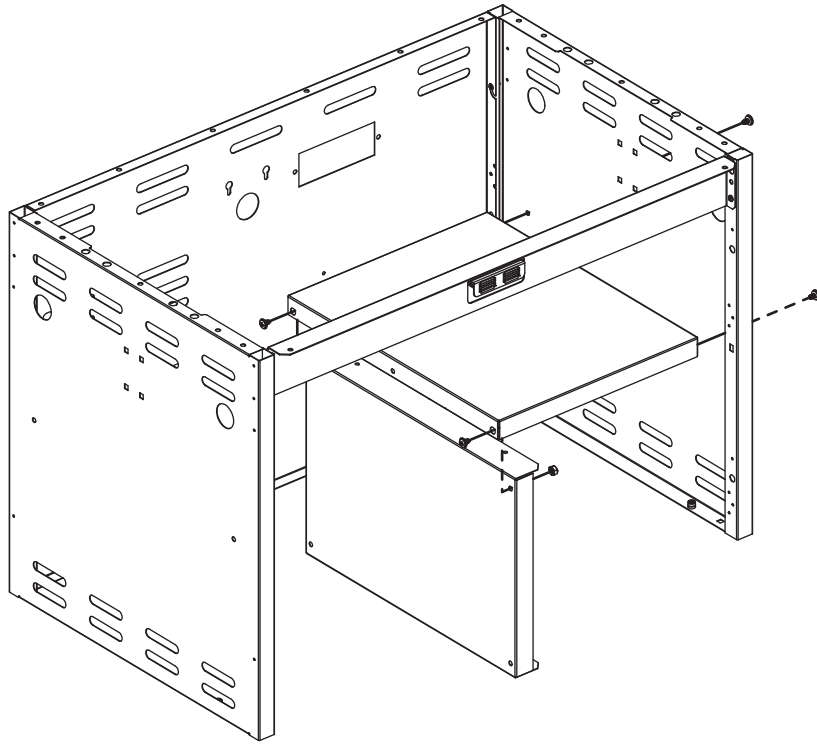

5133-82

5133-83

5133-86

**5**

(6)

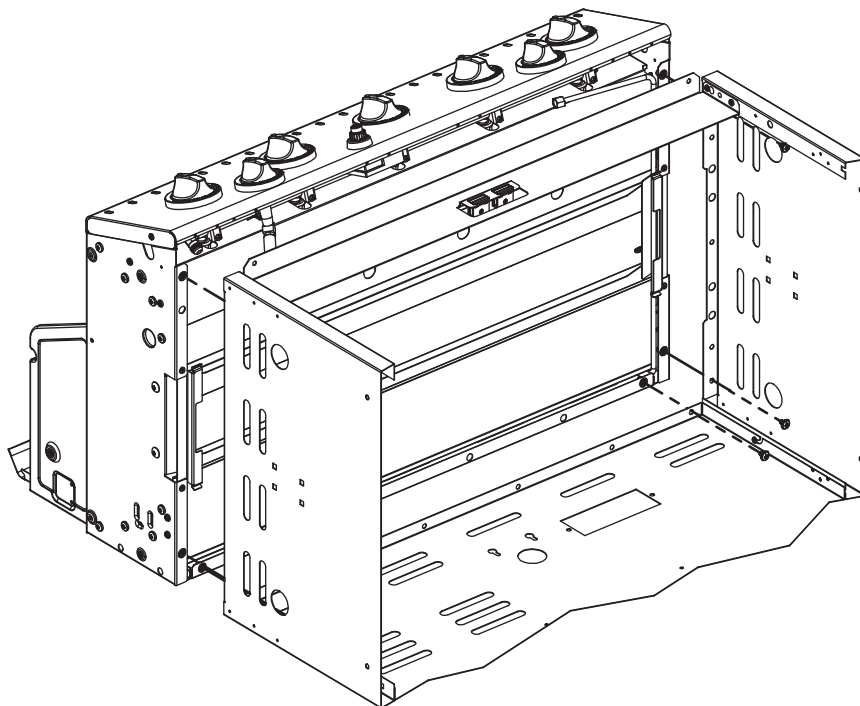
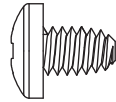

6

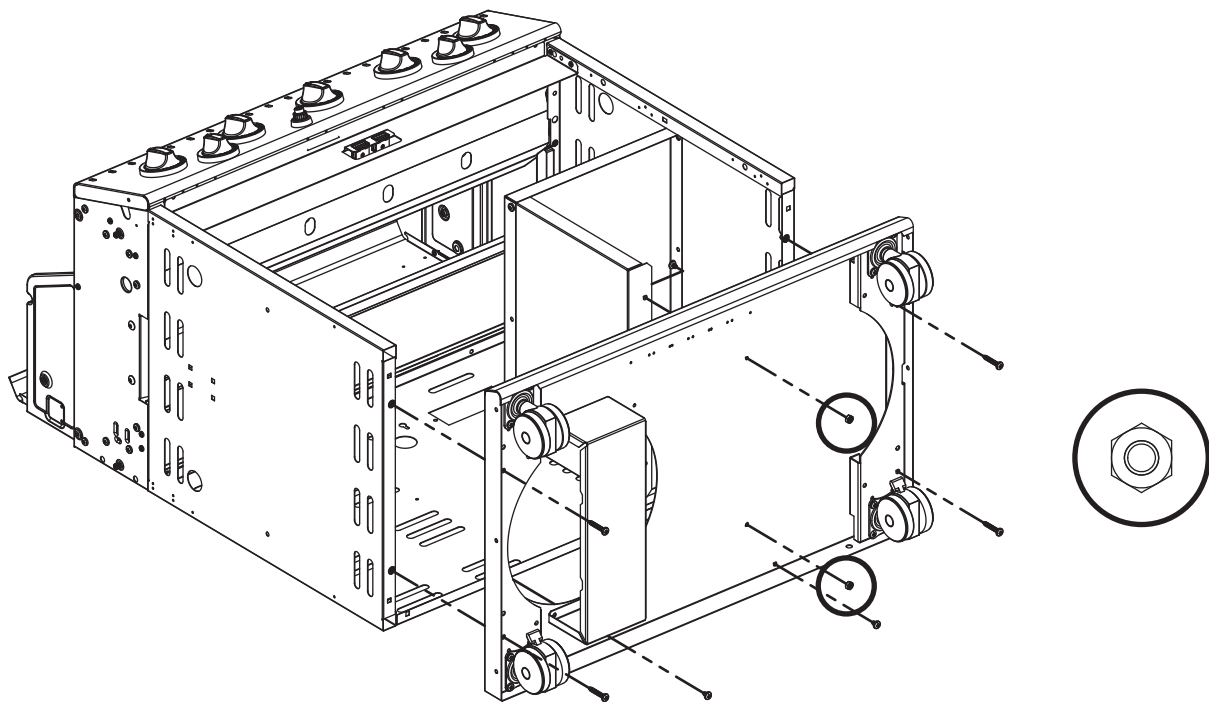
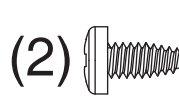
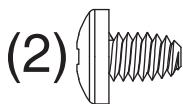
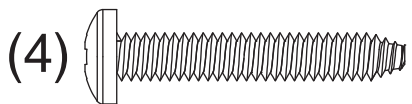

7

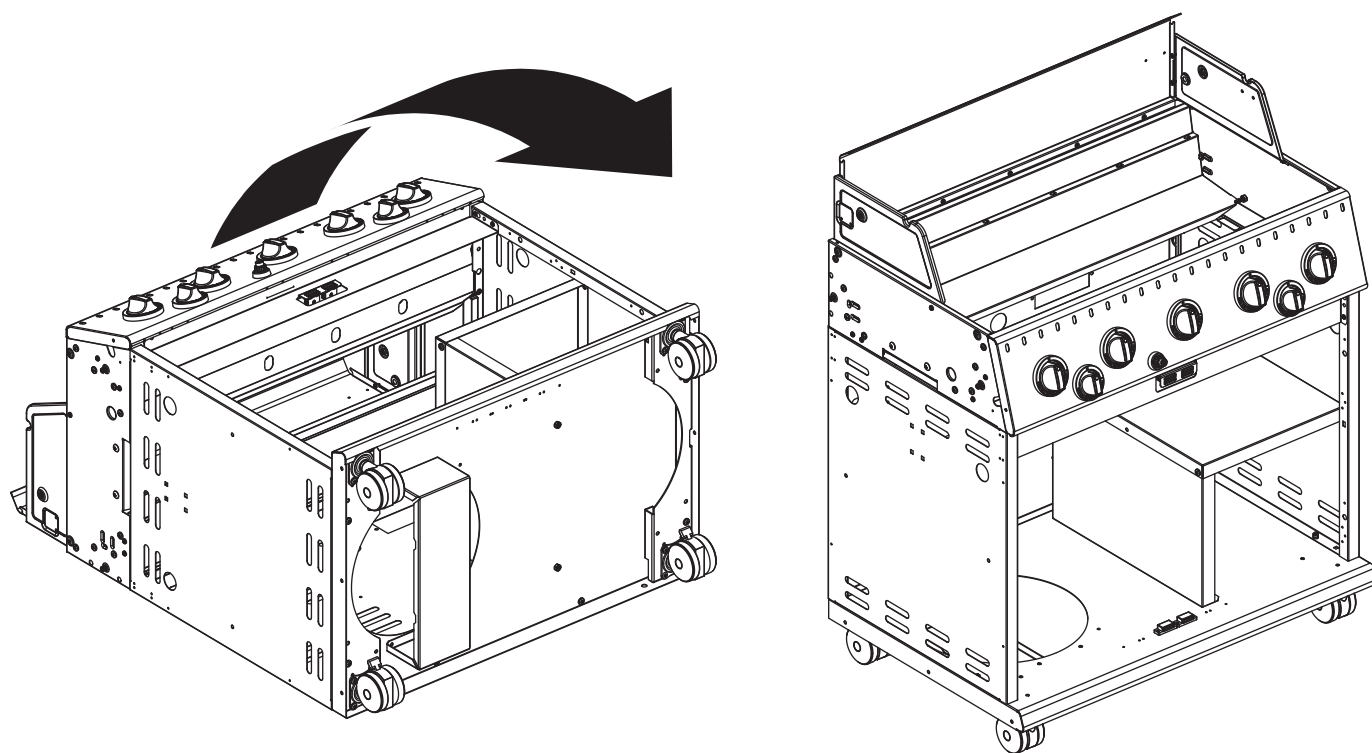

8

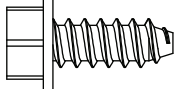
(4) 

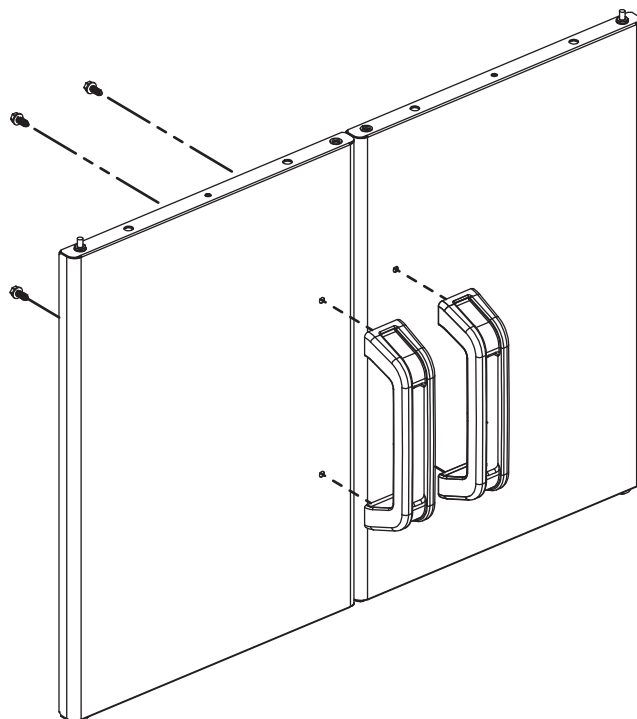

9

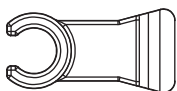
(2) 

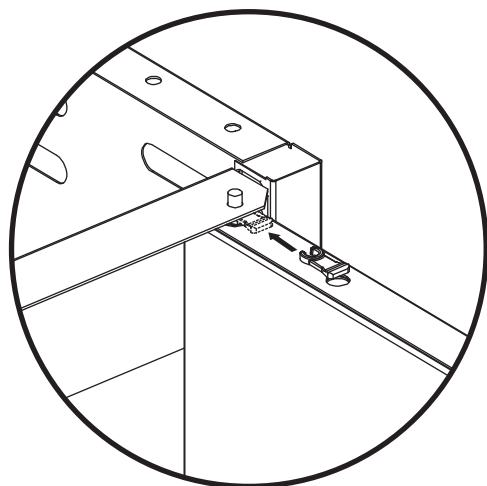
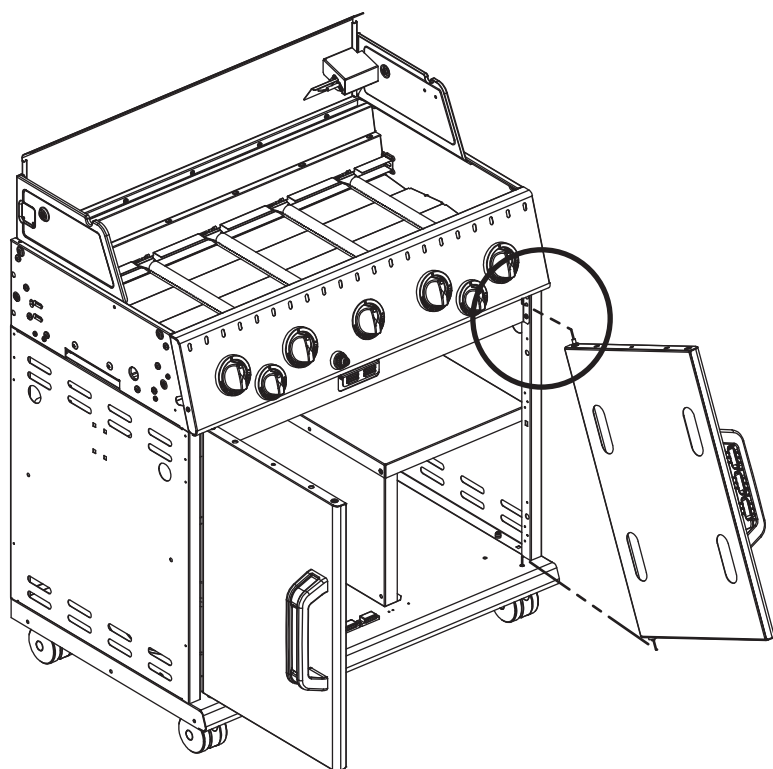

10

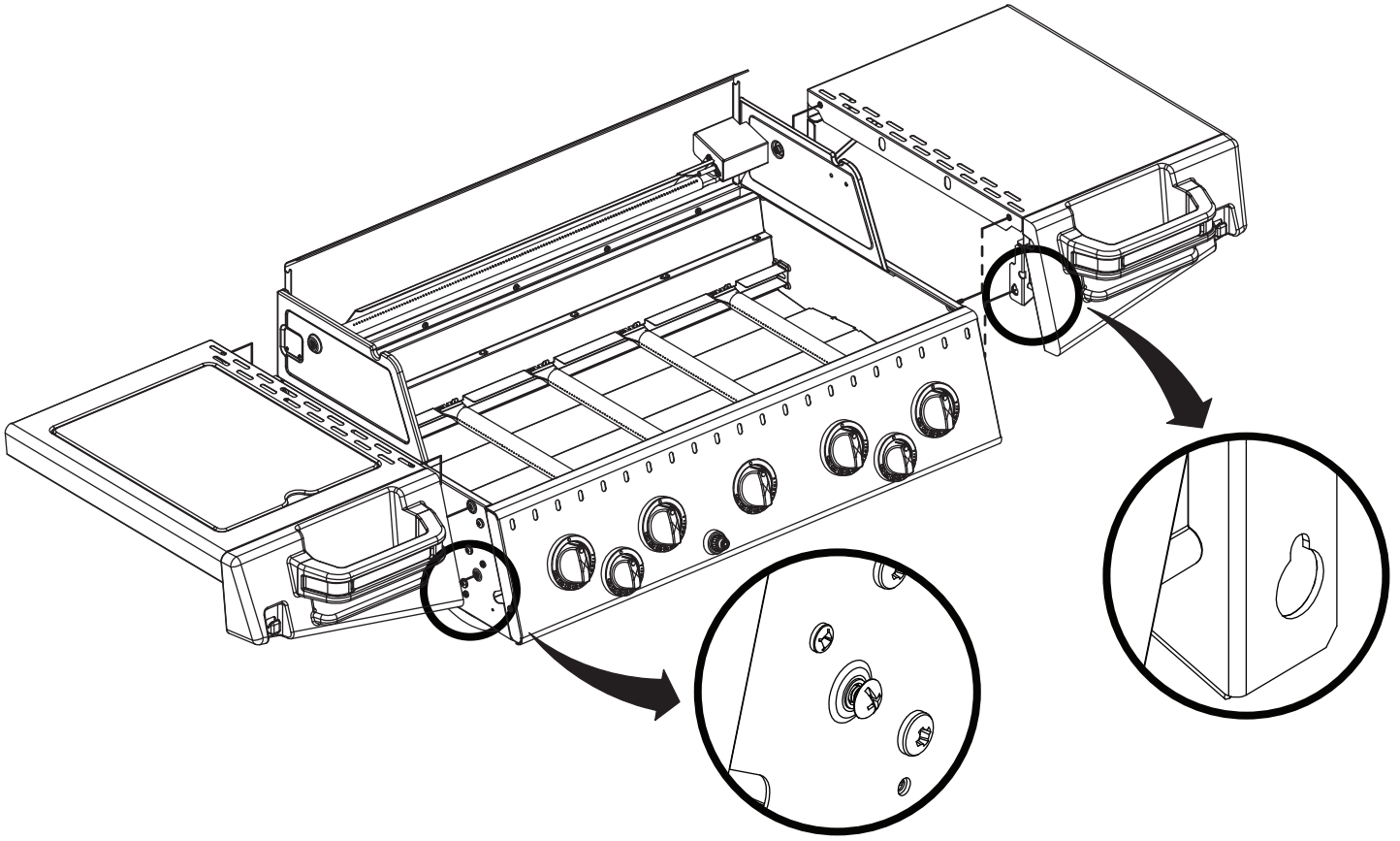

11

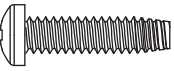
(4) 

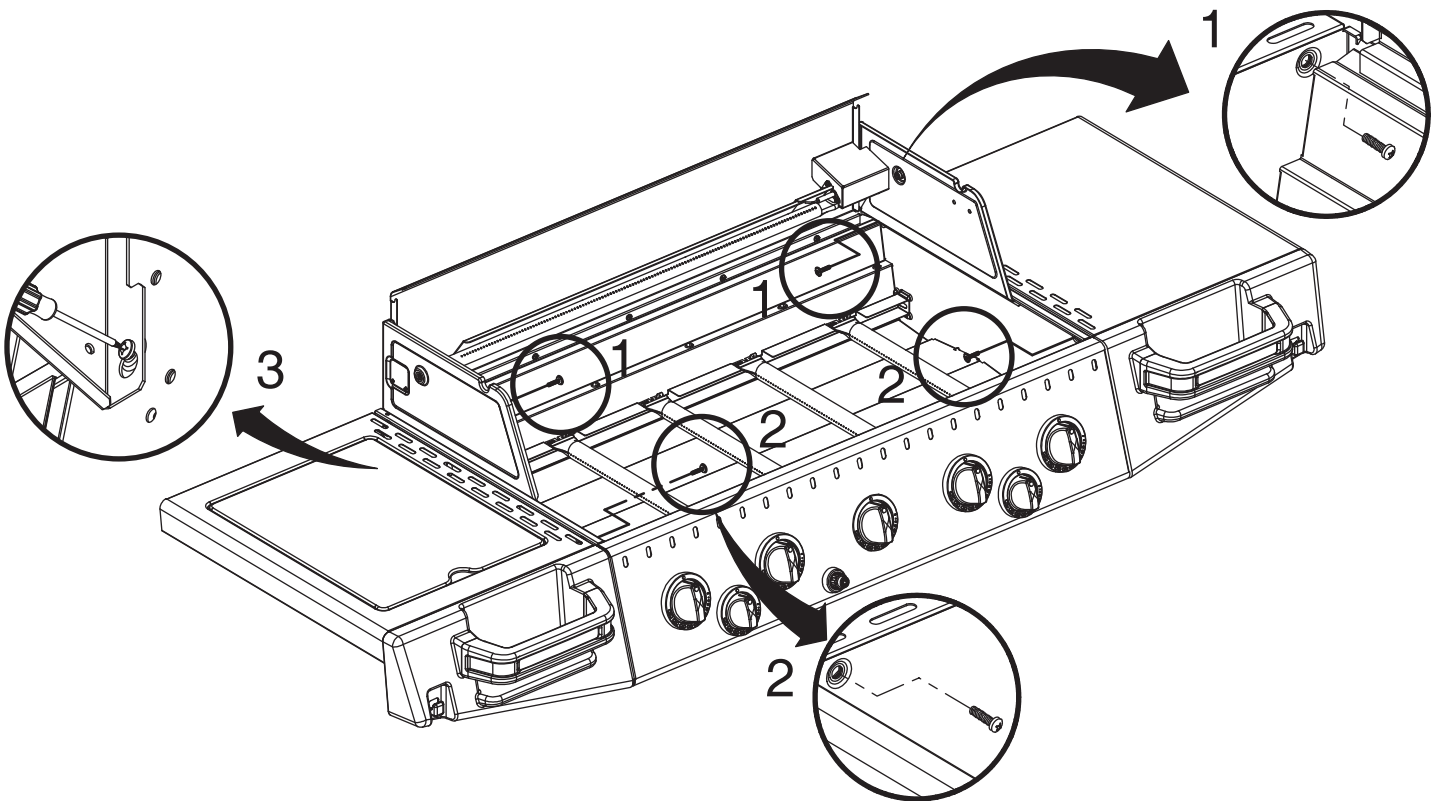

12

(1)

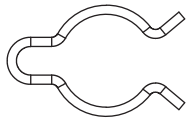

1

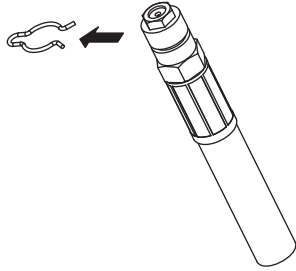

2

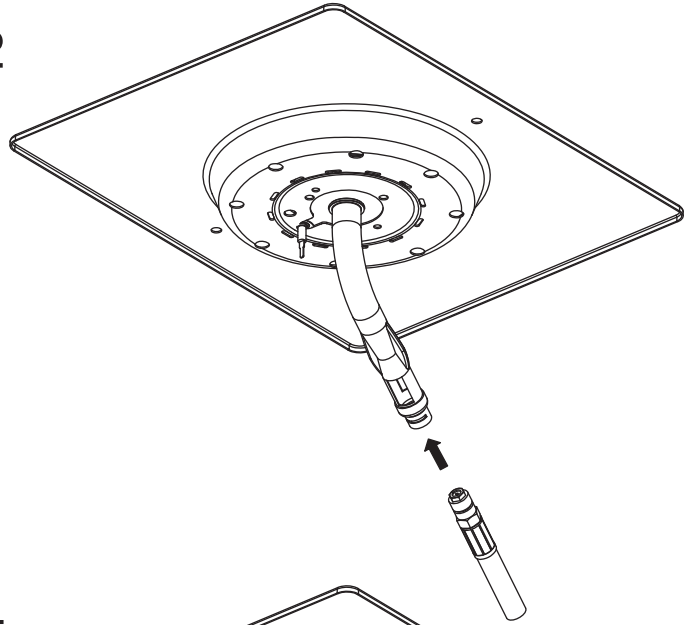

3

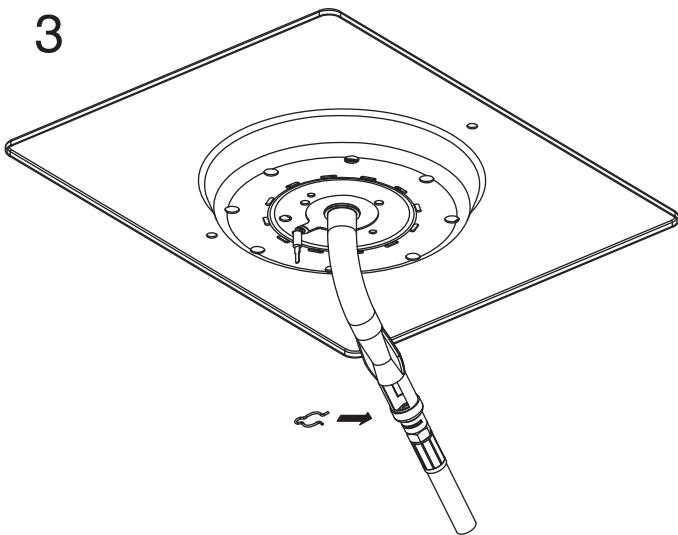

4

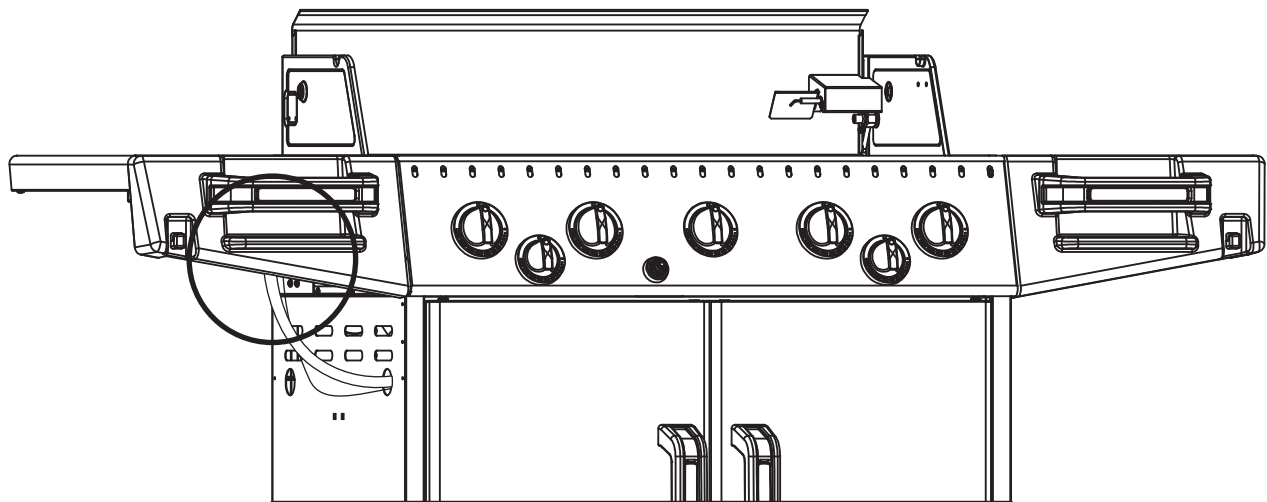
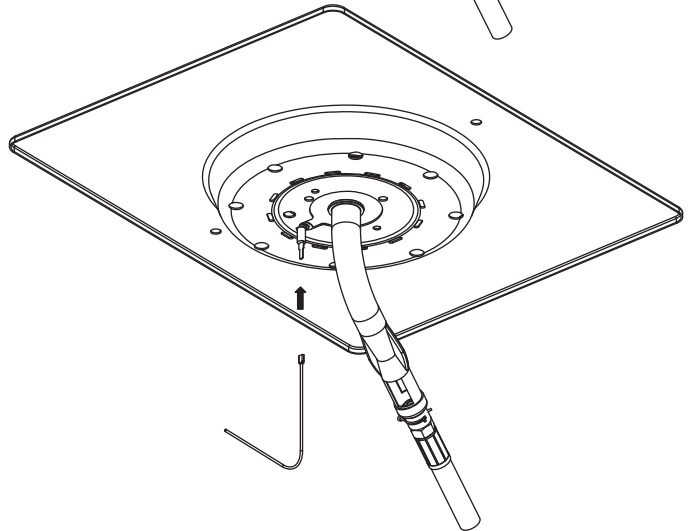

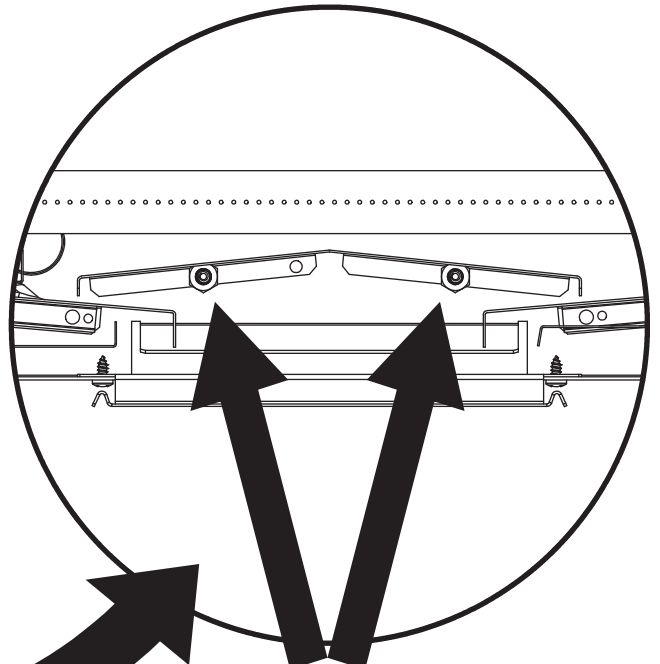
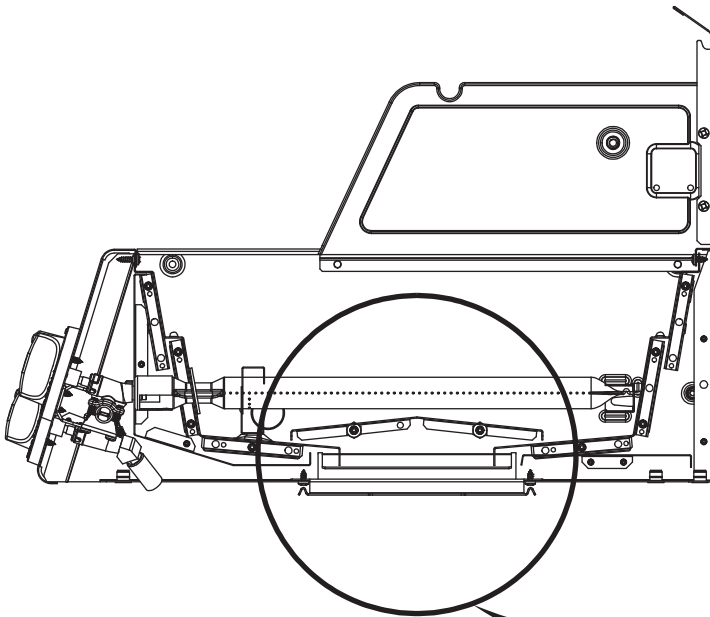
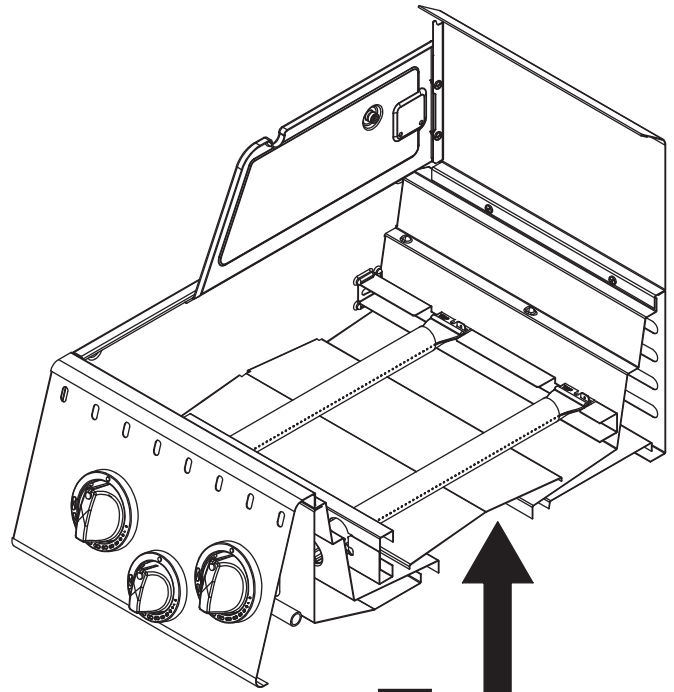
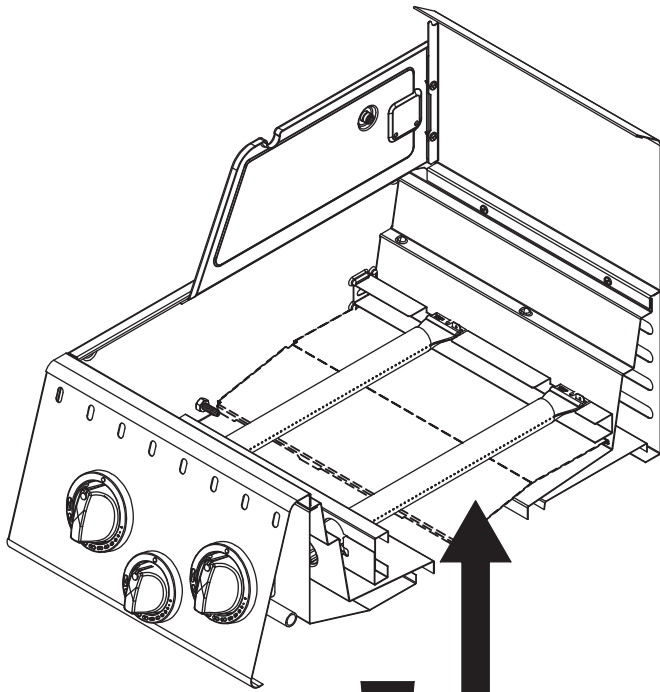

14

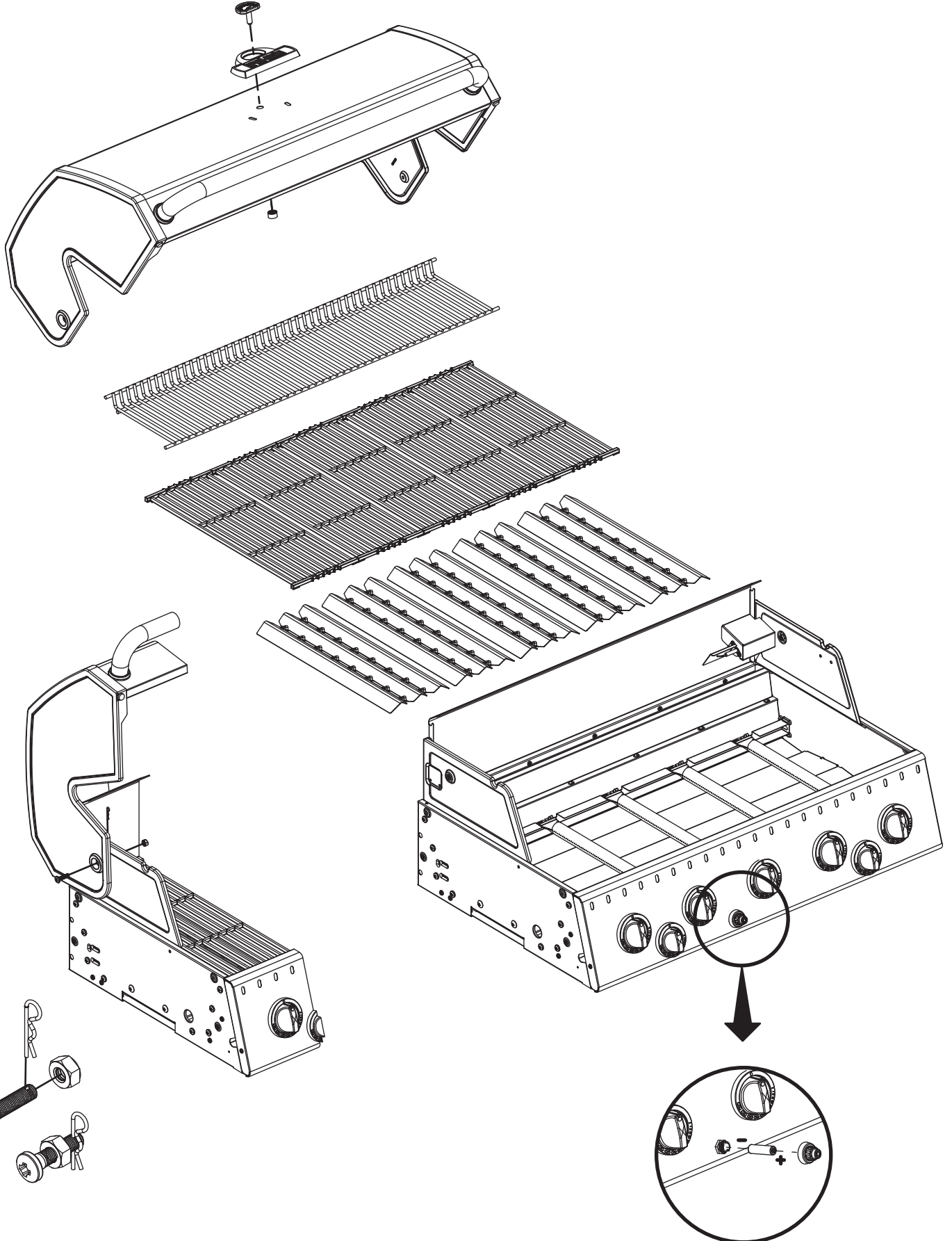
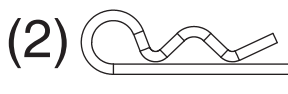
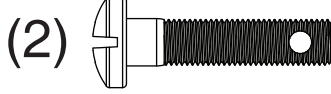

15

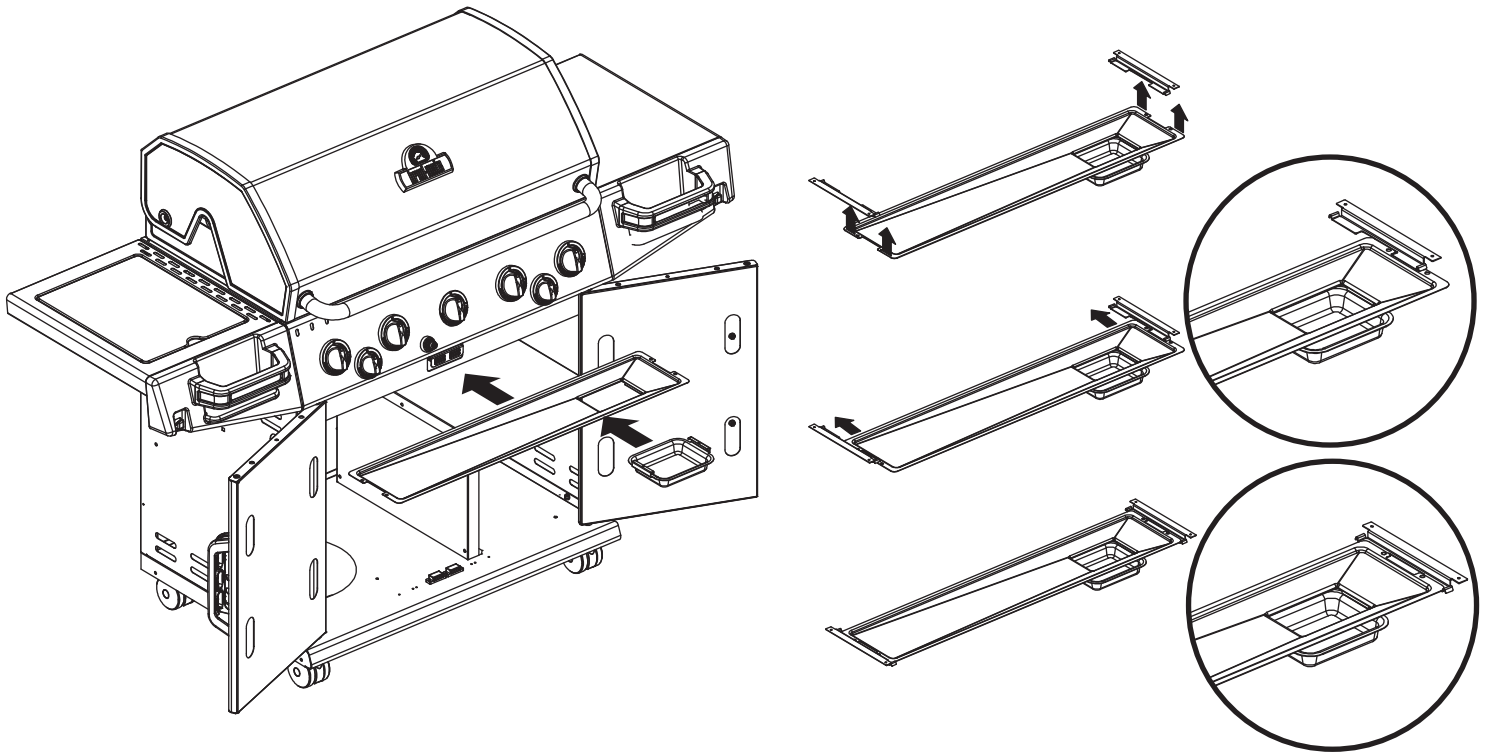

16

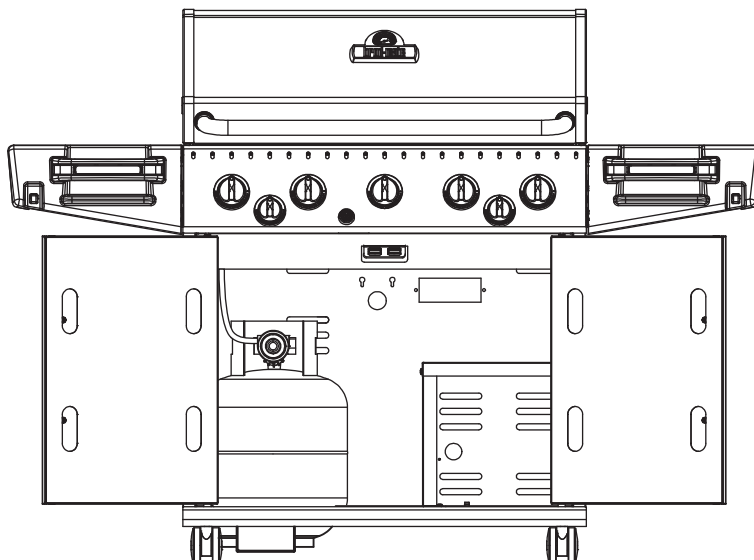

17

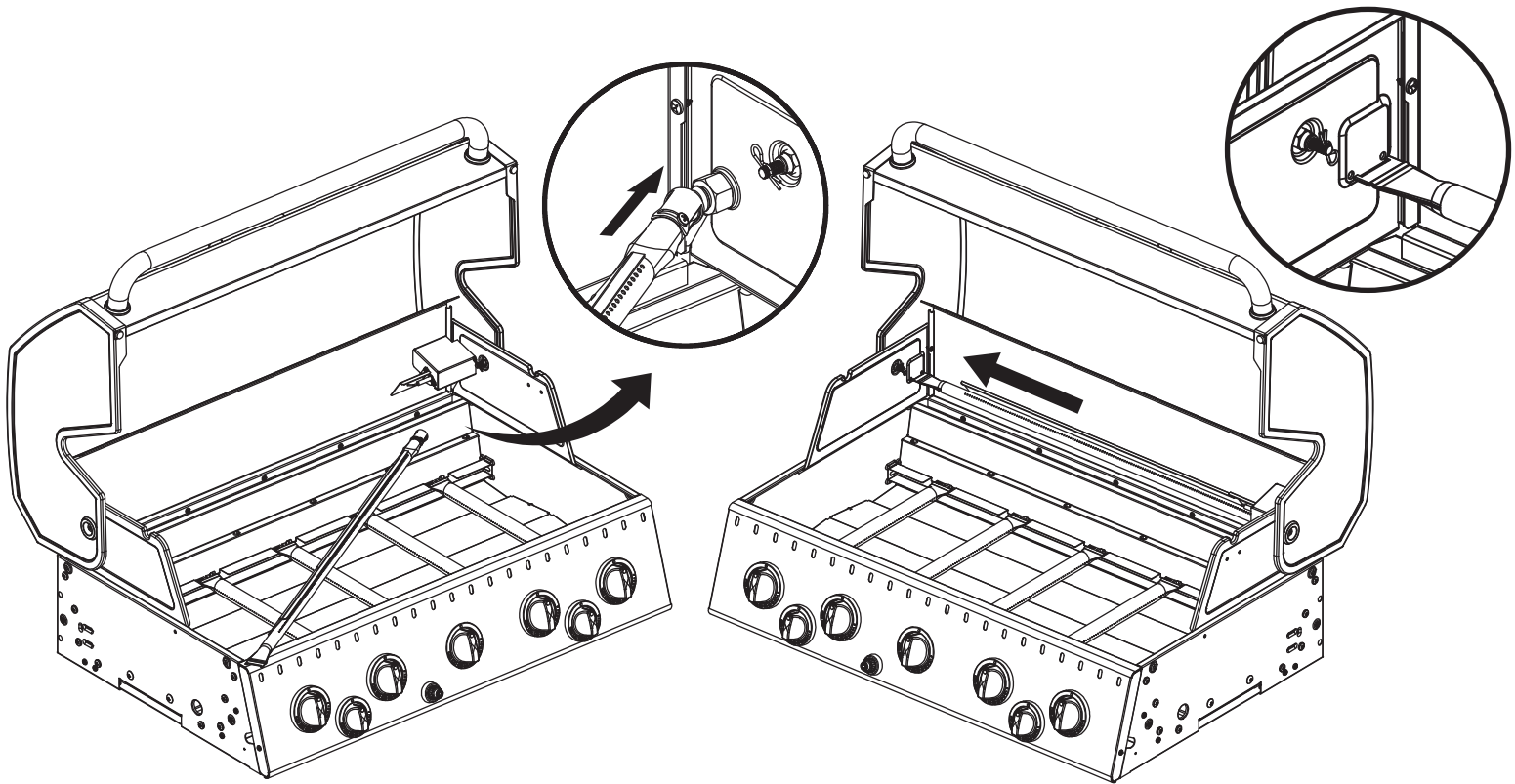

18

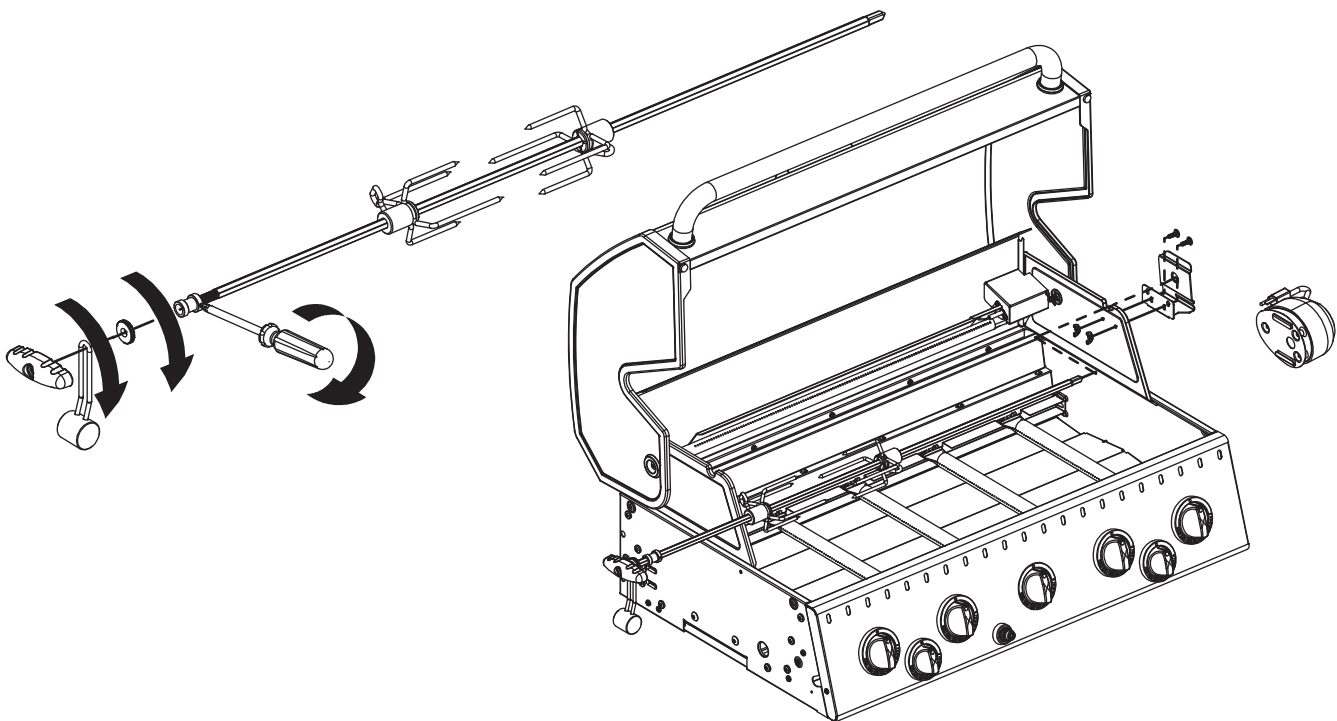

KEY #	ITEM #	5023-62	5023-63	5023-66	5023-82	5023-83	5023-86	5123-82	5123-83	5123-86	5133-82	5133-83	5133-86
1	56104-33	1	1	1	1	1	1	1	1	1	1	1	1
2	56104-31	1	1	1	1	1	1	1	1	1	1	1	1
3	56316-304	-	-	-	-	-	-	-	-	-	1	1	1
	56315-304	-	-	-	-	-	-	1	1	1	-	-	-
	56315-301	1	1	1	1	1	1	-	-	-	-	-	-
4	56246-30	-	-	-	-	-	-	-	-	-	1	1	1
	56245-30	1	1	1	1	1	1	1	1	1	-	-	-
5	24006-12A	-	-	-	-	-	-	-	-	-	1	1	1
	24005-12A	1	1	1	1	1	1	1	1	1	-	-	-
6	24009-936	2	2	2	2	2	2	2	2	2	2	2	2
8	10081-S60	-	-	-	-	-	-	-	-	-	1	1	1
	10081-S50	1	1	1	1	1	1	1	1	1	-	-	-
9	10571-6	-	-	-	-	-	-	-	-	-	1	1	1
	10571-5	1	1	1	1	1	1	1	1	1	-	-	-
11	52114-131	1	1	1	1	1	1	1	1	1	1	1	1
12	52114-111	1	1	1	1	1	1	1	1	1	1	1	1
13	52124-131	1	1	1	1	1	1	1	1	1	1	1	1
14	52124-111	1	1	1	1	1	1	1	1	1	1	1	1
15	52206-111	-	-	-	-	-	-	-	-	-	1	1	1
	52205-111	1	1	1	1	1	1	1	1	1	-	-	-
16	52206-121	-	-	-	-	-	-	-	-	-	1	1	1
	52205-121	1	1	1	1	1	1	1	1	1	-	-	-
17	27246-904	-	-	-	-	-	-	-	-	-	1	1	1
	27245-904	1	1	1	1	1	1	1	1	1	-	-	-
18	52046-91	-	-	-	-	-	-	-	-	-	1	1	1
	52045-91	1	1	1	1	1	1	1	1	1	-	-	-
19	52046-92	-	-	-	-	-	-	-	-	-	1	1	1
	52045-92	1	1	1	1	1	1	1	1	1	-	-	-
20	57236-024	-	-	-	-	-	-	-	-	-	1	1	1
	57235-024	1	1	1	1	1	1	1	1	1	-	-	-
21	S21232	4	4	4	4	4	4	4	4	4	5	5	5
22	52306-121	-	-	-	-	-	-	-	-	-	1	1	1
	52305-121	1	1	1	1	1	1	1	1	1	-	-	-
23	52316-151	-	-	-	-	-	-	-	-	-	1	1	1
	52315-151	1	1	1	1	1	1	1	1	1	-	-	-
25	52904-144	4	4	4	4	4	4	4	4	4	5	5	5
26	52226-014	-	-	-	-	-	-	-	-	-	1	1	1
	52225-014	1	1	1	1	1	1	1	1	1	-	-	-
27	52216-014	-	-	-	-	-	-	-	-	-	1	1	1
	52215-014	1	1	1	1	1	1	1	1	1	-	-	-
28	52016-304	-	-	-	-	-	-	-	-	-	1	1	1
	52015-304	-	-	-	1	1	1	1	1	1	-	-	-
	52015-244	1	1	1	-	-	-	-	-	-	-	-	-
29	59006-072	-	-	-	-	-	-	-	-	-	1	-	-
	59006-075	-	-	-	-	-	-	-	-	-	-	1	-
	59006-076	-	-	-	-	-	-	-	-	-	-	-	1
	59005-072	-	-	-	1	-	-	1	-	-	-	-	-
	59005-075	-	-	-	-	1	-	-	1	-	-	-	-
	59005-076	-	-	-	-	-	1	-	-	1	-	-	-
	59005-032	1	-	-	-	-	-	-	-	-	-	-	-
	59005-035	-	1	-	-	-	-	-	-	-	-	-	-
	59005-036	-	-	1	-	-	-	-	-	-	-	-	-
30	S13470-066	1	-	-	1	-	-	1	-	-	1	-	-
	S13470-079	-	1	-	-	1	-	-	1	-	-	1	-
	S13470-109	-	-	1	-	-	1	-	-	1	-	-	1
32	27906-35	-	-	-	-	-	-	-	-	-	1	1	1
	27905-35	-	-	-	1	1	1	1	1	1	-	-	-
33	50809-957	-	-	-	1	1	1	1	1	1	1	1	1
34	22339-304	-	-	-	1	1	1	1	1	1	1	1	1
35	22949-504	-	-	-	1	1	1	1	1	1	1	1	1
36	10342-T17	-	-	-	1	1	1	1	1	1	1	1	1
38	22002-268	4	4	4	4	4	4	4	4	4	5	5	5
39	22001-168	1	1	1	2	2	2	2	2	2	2	2	2
40	10472-K431	4	4	4	4	4	4	4	4	4	5	5	5
41	50479-K231	1	1	1	2	2	2	2	2	2	2	2	2
42	10342-251	-	-	-	-	-	-	-	-	-	1	1	1
	10342-247	-	-	-	1	1	1	1	1	1	-	-	-
	10342-246	1	1	1	-	-	-	-	-	-	-	-	-
43	10342-E13	2	2	2	2	2	2	2	2	2	3	3	3
44	52209-404	4	4	4	4	4	4	4	4	4	5	5	5
45	52007-181	4	4	4	4	4	4	4	4	4	5	5	5
46	52006-991	-	-	-	-	-	-	-	-	-	1	1	1



