

This Owner's Manual is provided and hosted by [Appliance Factory Parts](#).



Broil-Mate 7821-87 Owner's Manual

[Shop genuine replacement parts for Broil-Mate 7821-87](#)



[Find Your Broil-Mate Grill Parts - Select From 682 Models](#)

----- Manual continues below part list -----

Available Replacement Parts for Broil-Mate 7821-87

18013	LARGE PROBE HEAT INDICATOR
S21124	SCREW PHCP #8 X 12 +
10390-E10	BURNER SIDE 10BTU W/ELEC #8 +
Y-12220	S/B BUSHING SB 1.375 16 HEY
S15263	ROTISSERIE BUSHING
S15299	WASHER COUNTERWEIGHT ROTIS
S15270	ROTISSERIE COUNTERWEIGHT ASSY
S15271	ROTISSERIE HANDLE +
10342-246	IGNITOR ELECTRONIC TRIPLE +
Y-12223	MAGNET SNAP IN - DOOR
Y-12222	MAGNET - DOOR
10342-E13	ELECTRODE W/WIRE
10342-T18	WIRE ELECTRODE S/B 600 +
S15245	ROTIS MOTOR-220V AC +
10240-20	DOOR PIN TOP
10240-19	DOOR PIN BOTTOM
27055-901	GREASE TRAY PORC FORMED 440 +
52045-92	FIREBOX 440 HEAT SHIELD REAR
52315-151	FIREBOX 440 HOOD PANEL PORC
59005-034	CONTROL ASSY 4V S/B LP
59005-037	CONTROL ASSY 4V S/B NG
18431	OEM FLAV R WAVE - BARON
52007-181	COOKING GRID 550 PORC BLK +
S15256	SPIT ROD ROTISSERIE 31 INCH
52305-121	FIREBOX 440 OUTER REAR
20005-000	HARDWARE BAG STICK & CHAIN SS
10693-165	ORIFICE SPUD 1.63MM 5/16-32
10892-23	CASTER RUBBER 3 INCH W/PLATE
52015-903	COLLECTOR BOX ASSEMBLY 440
51175-111A	DOOR ASSEMBLY 440 RHS BLACK

51175-131A	DOOR ASSEMBLY 440 LHS BLACK
51175-114A	DOOR ASSEMBLY 440 RHS SS
51175-134A	DOOR ASSEMBLY 440 LHS SS
10693-113	ORIFICE SPUD 1.13MM 5/16 32
51039-951	CASTER BRACKET BLACK 330/440/550
52002-284	COOKING GRID SS, Each
52065-91	FIREBOX 440 HEAT SHIELD FRONT
53184-118	SHELF END CAP RHS 330/440
53184-138	SHELF END CAP LHS 330/440
53404-114	SHELF FRONT FACIA RHS 330/440
57039-901	ROTISSERIE BRACKET BLK
59005-014	CONTROL ASSY 4V LP
53009-951	SIDE BURNER TRIVET BLK
S15508	REAR BURNER ELECTRODE WIRE +
50502	HEAVY DUTY MEAT FORKS
53104-111	SHELF RHS BLK 330/440
59005-017	CONTROL ASSY 4V NG
10081-69H	NAMEPLATE HUNTINGTON LRG
10081-69S	NAMEPLTE STERLING LRG CHRME SRFACE MOUNT
52924-144R	BURNER - MAIN
10111-K45	HOSE 3/8 INCH ASSEMBLY NG 10 FOOT +
10081-69BM	NAMEPLATE BROILMATE
Y-11990	NUT HEX BRASS 3/8 27 RB LINE
24009-936	HANDLE RING
10342-247	IGNITOR ELECTRONIC +
10472-K431	CONTRL KNOB RESIN LRG BLCK W/SS BA STRIP
21071-13	DOOR HANDLE 500 GPB
22001-168	CONTROL KNOB BEZEL SML
22002-268	CONTROL KNOB BEZEL LARGE
24005-12AB	LID-HANDLE BENT,
52809-957	MANIFOLD - REAR BURNER AB
52005-991	WARMING RACK 440 PORC
21035-991	GREASE RAIL 440/500 SABLE BLK

59005-074	CONTROL ASSY 4V S/B R/B LP +
59005-077	VALVE ASSY 440 S/B R/B NG
21009-951	TANK COLLAR CLAMP 625/750 BLK PULL OUT
27905-354	BURNER TUBE REAR 500 W/WINDSHIELD
51239-901	TANK PREVENTION BRACKET 440 + BLK
51335-211	TOP MAGNET BRACKET 440 BLACK
52009-901	GREASE PAN - BLACK HIGH HEAT PAINT
57139-13	BRACKET U-CHANNEL REAR 330/440/550
10111-15A	HOSE ASSEMBLY SS
10114-16	HOSE & REG ASSY 17 INCH LP +
52904-144NG	BURNER ASSY MAIN SINGLE TUBE + NG
27249-904	GREASE SHIELD MODULAR, 6.5 x 6



ASSEMBLY MANUAL & PARTS LIST • MANUEL DE MONTAGE & LISTE DE PIÈCES • MANUAL DE ARMADO Y LISTA DE PARTES



STERLING 6
5821-84/87

HUNTINGTON™
6821-84/87

broil-mate™
7821-84/87



STERLING 6
5825-84/87

HUNTINGTON™
6825-84/87

broil-mate™
7825-84/87



STERLING 6
5821-64/67

HUNTINGTON™
6821-64/67

broil-mate™
7821-64/67



STERLING 6
5825-64/67

HUNTINGTON™
6825-24/27
6825-64/67

broil-mate™
7825-64/67



STERLING 6
5821-54/57

HUNTINGTON™
6821-54/57

broil-mate™
7821-54/57



STERLING 6
5825-54/57

RETAIN FOR FUTURE REFERENCE • VEUILLEZ CONSERVER POUR REFERENCE ULTERIEURE • CONSERVER PARA FUTURAS CONSULTAS



SINCE 1906

MANUFACTURING COMPANY

1000 EAST MARKET STREET
HUNTINGTON, INDIANA, 46750, USA

1-800-265-2150

info@omcbbq.com

50084-E47 Rev K 08/16

1

(8)

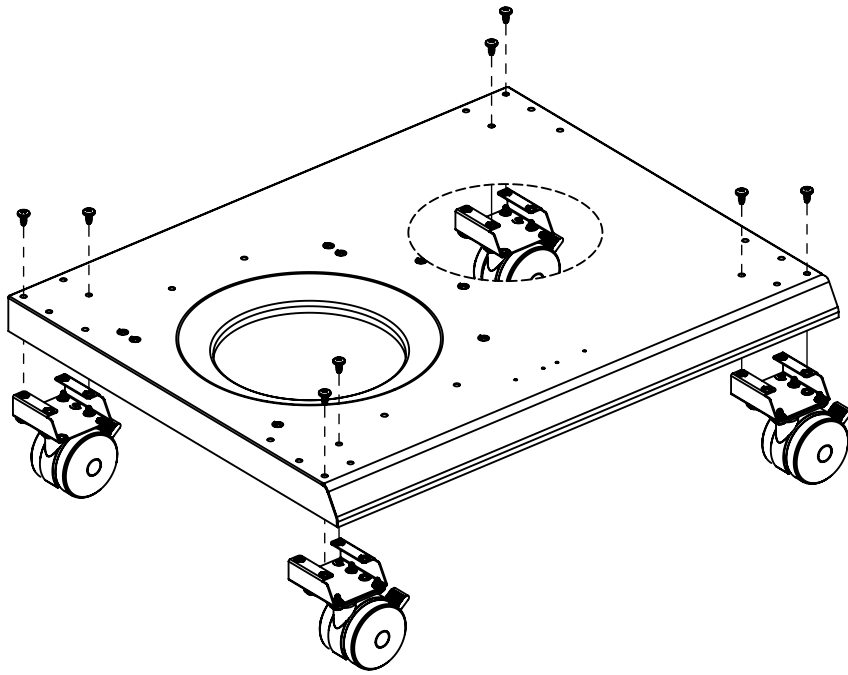
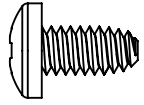

2

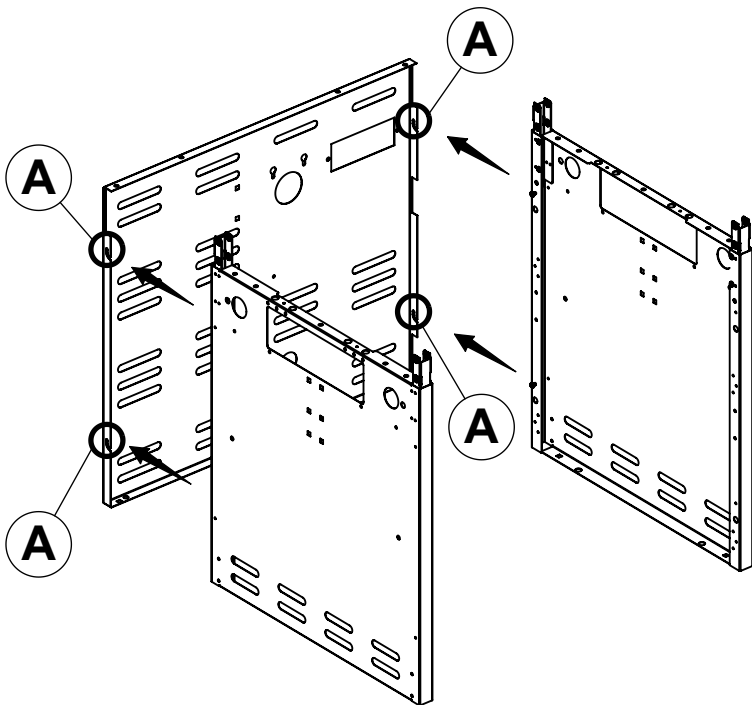

1

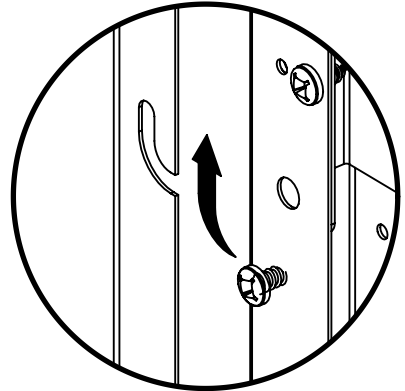

2

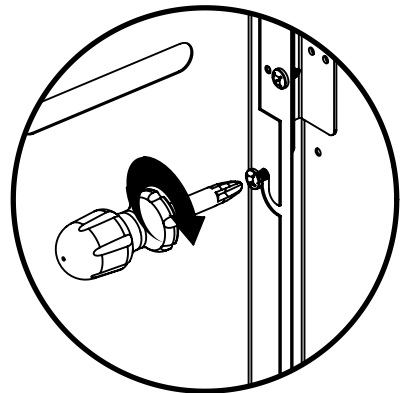

3

(6)

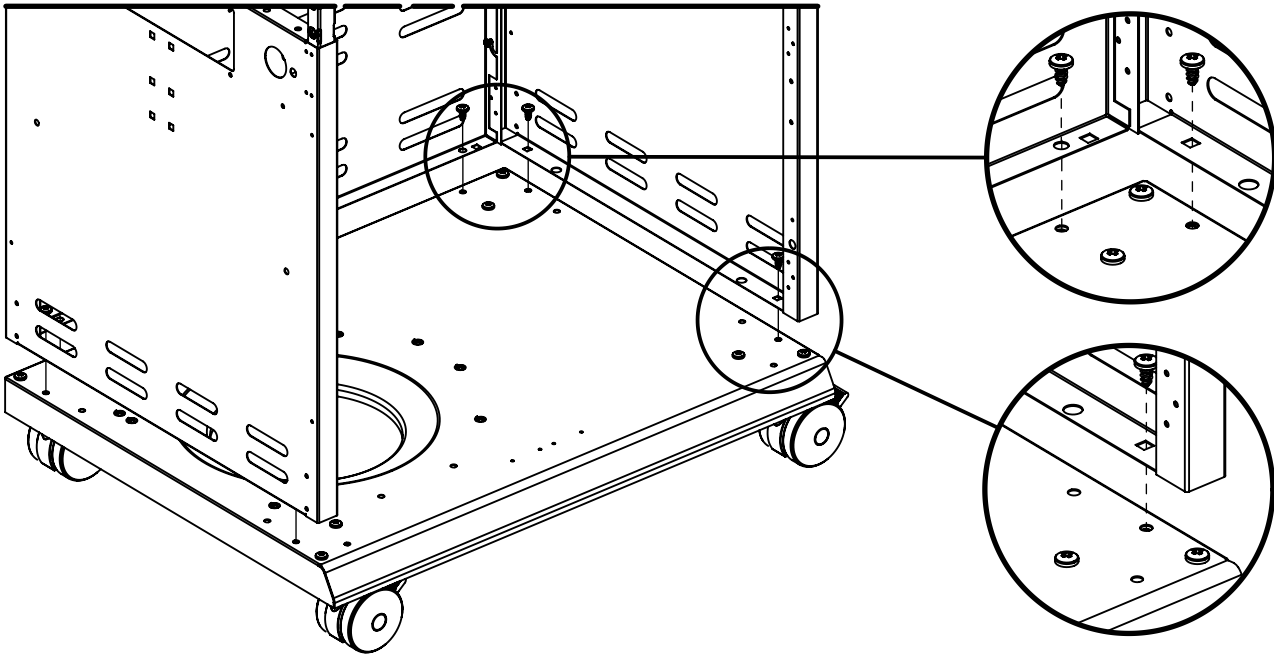
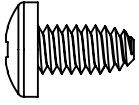

4

(4)

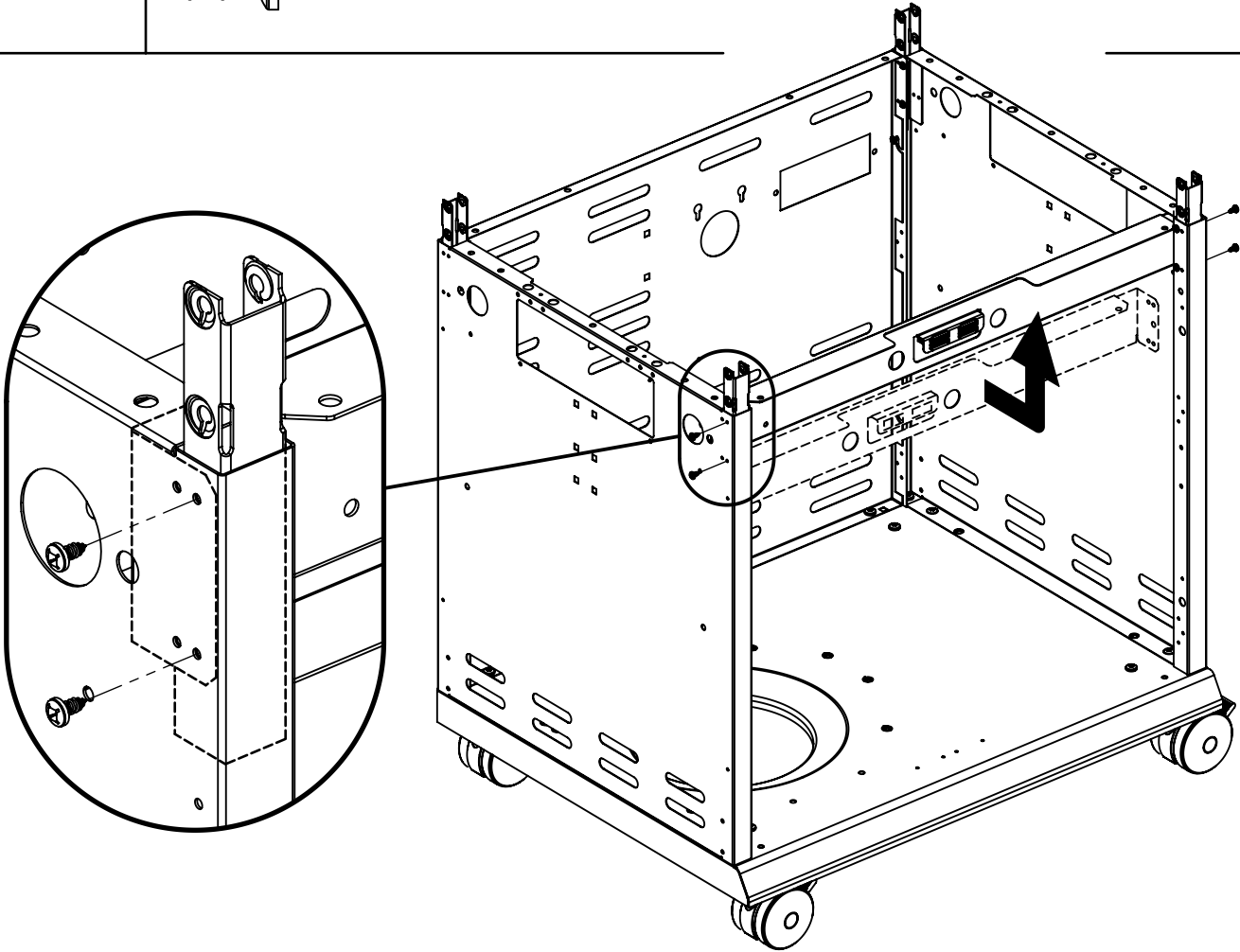
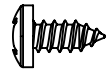

5

(4) 

(1) 

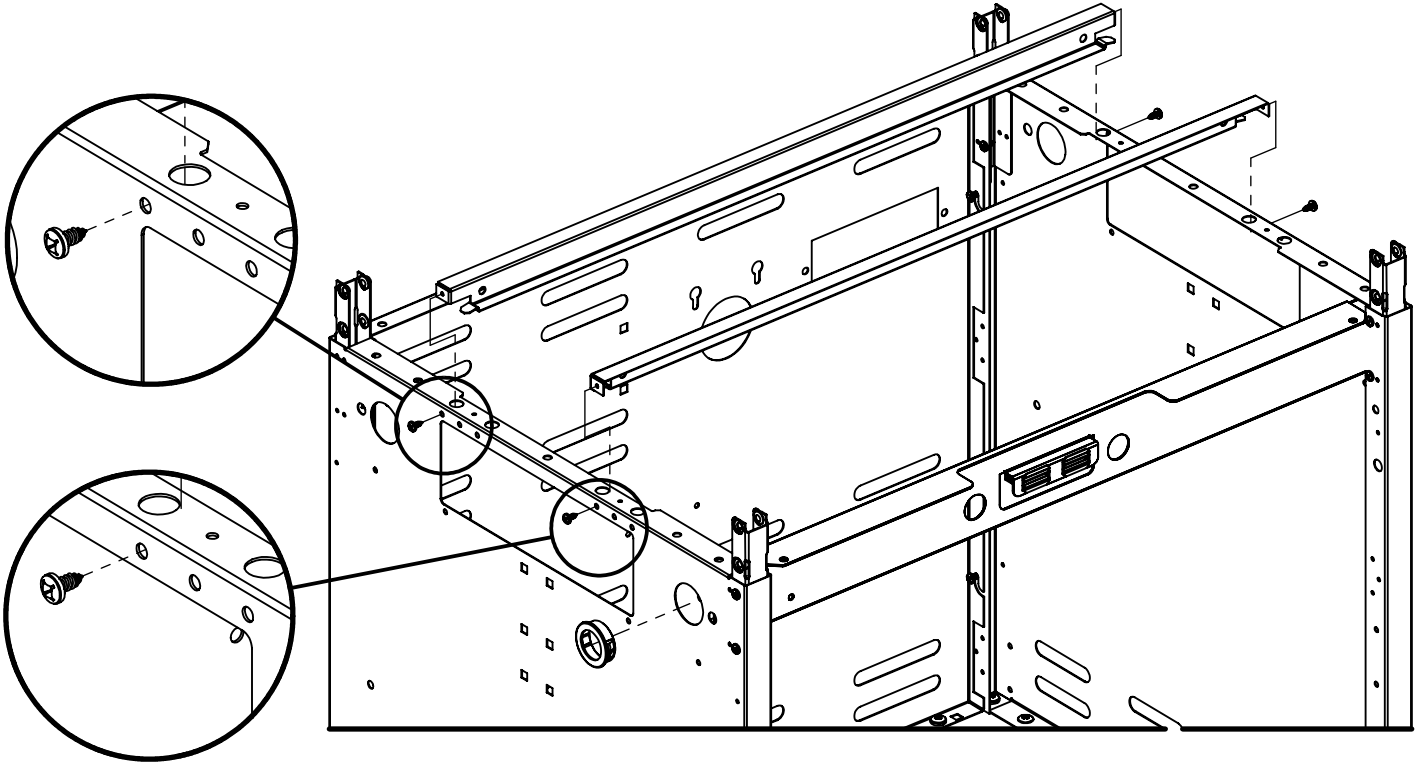

6

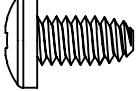
(4) 

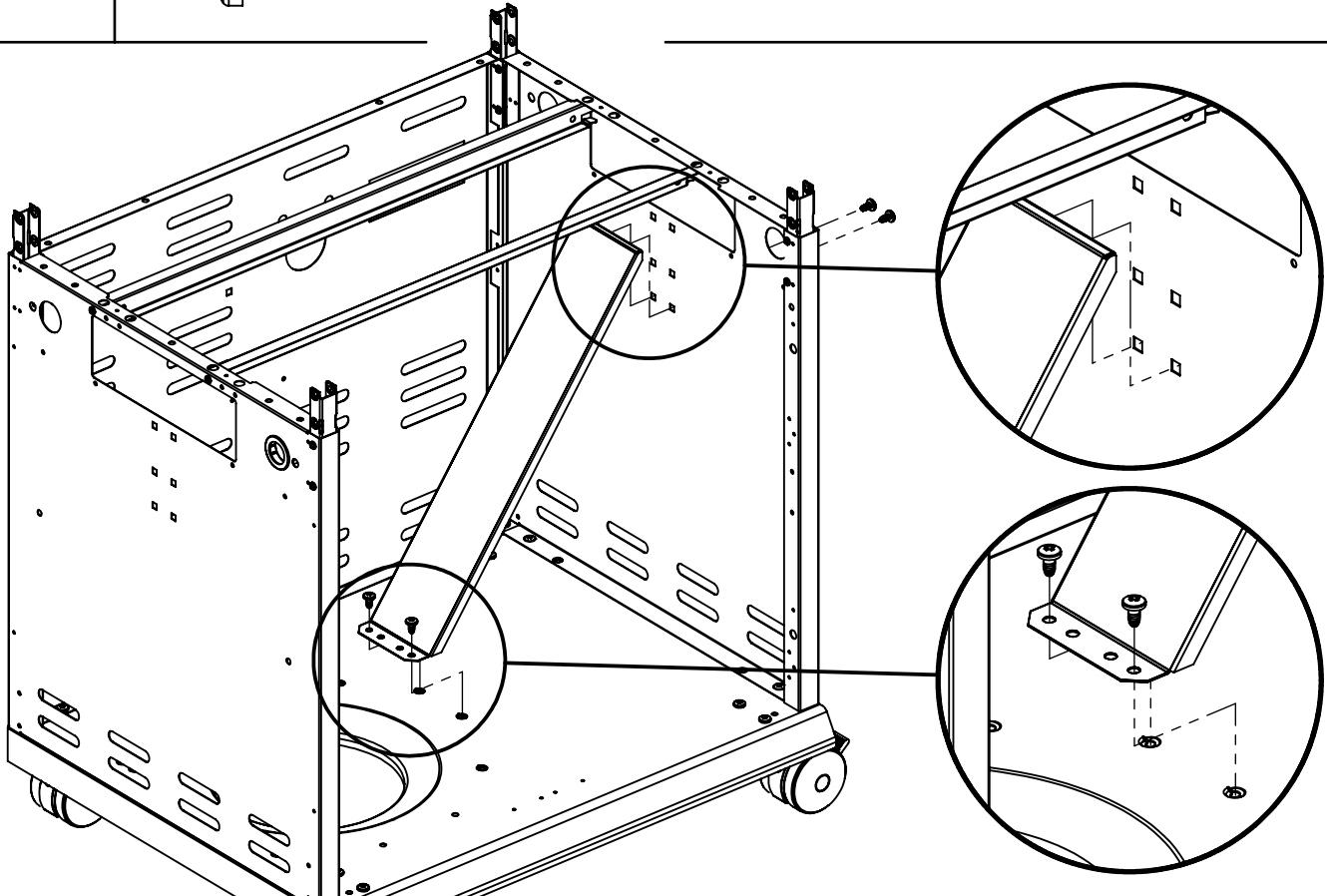

7

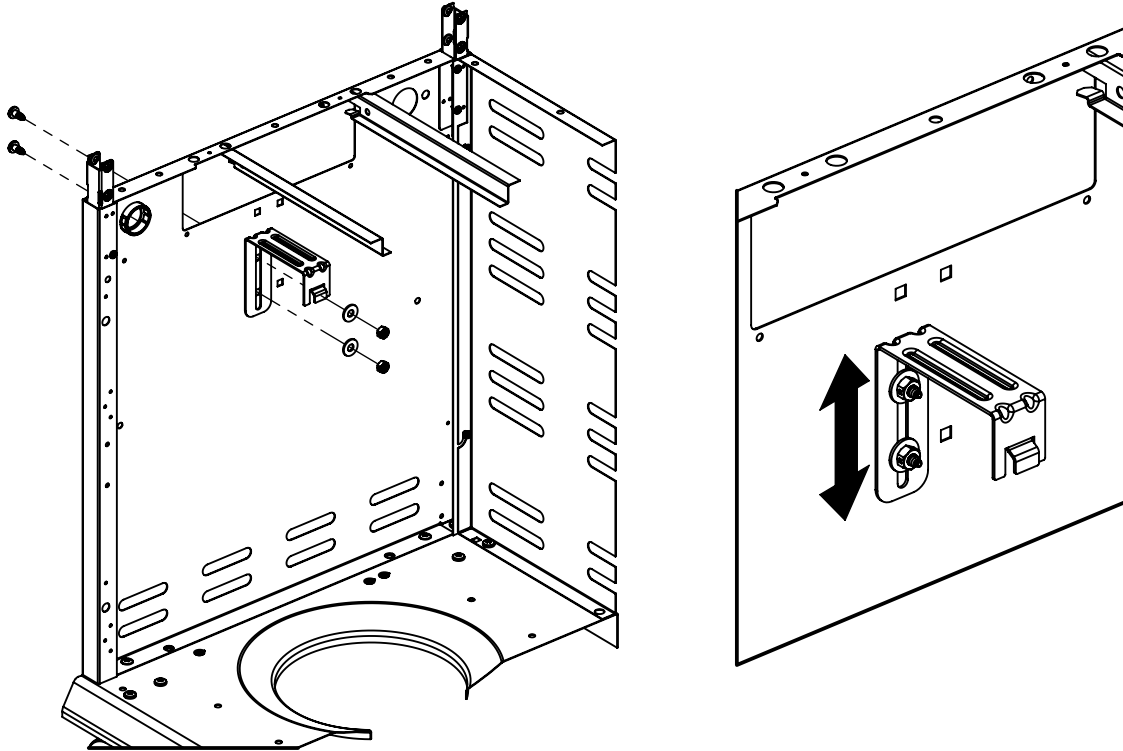

8

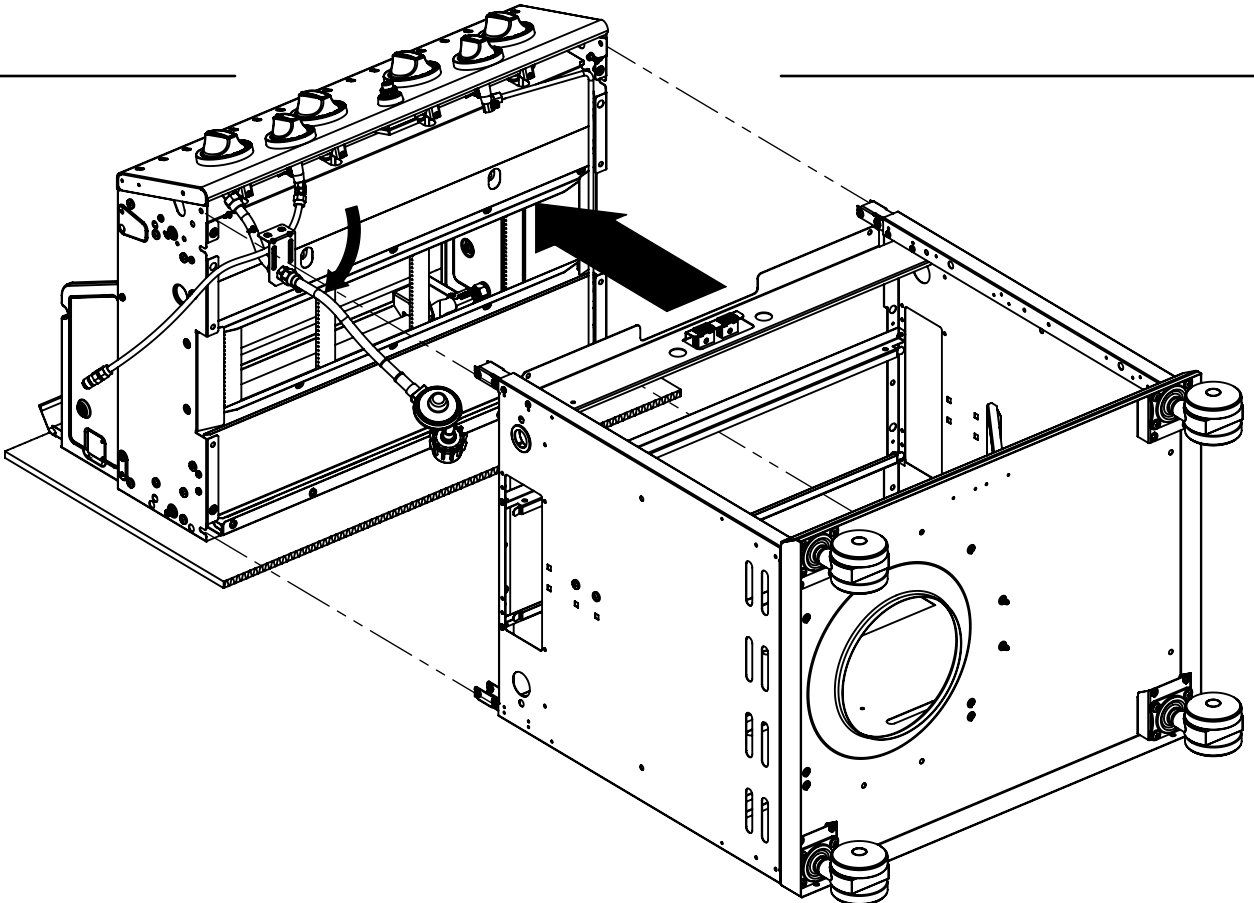

9

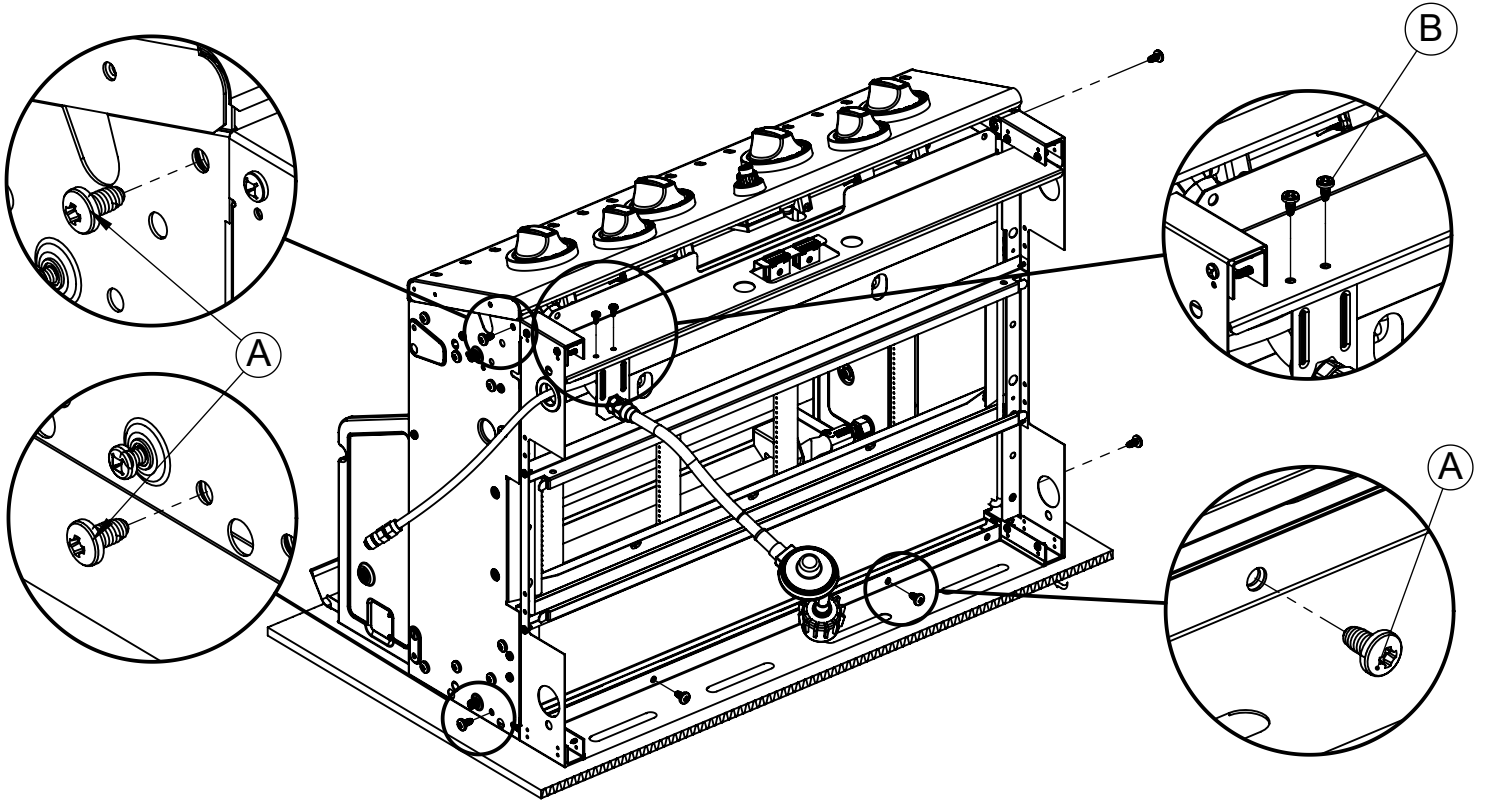
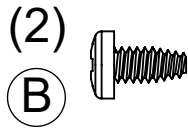
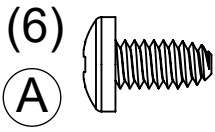

10



11

(4)

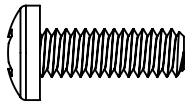

(4)

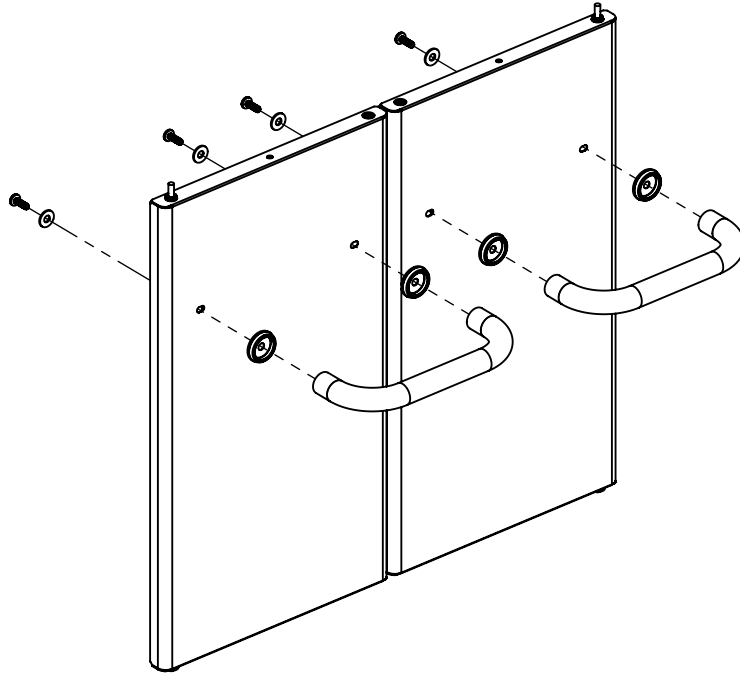
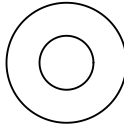

12

(2)

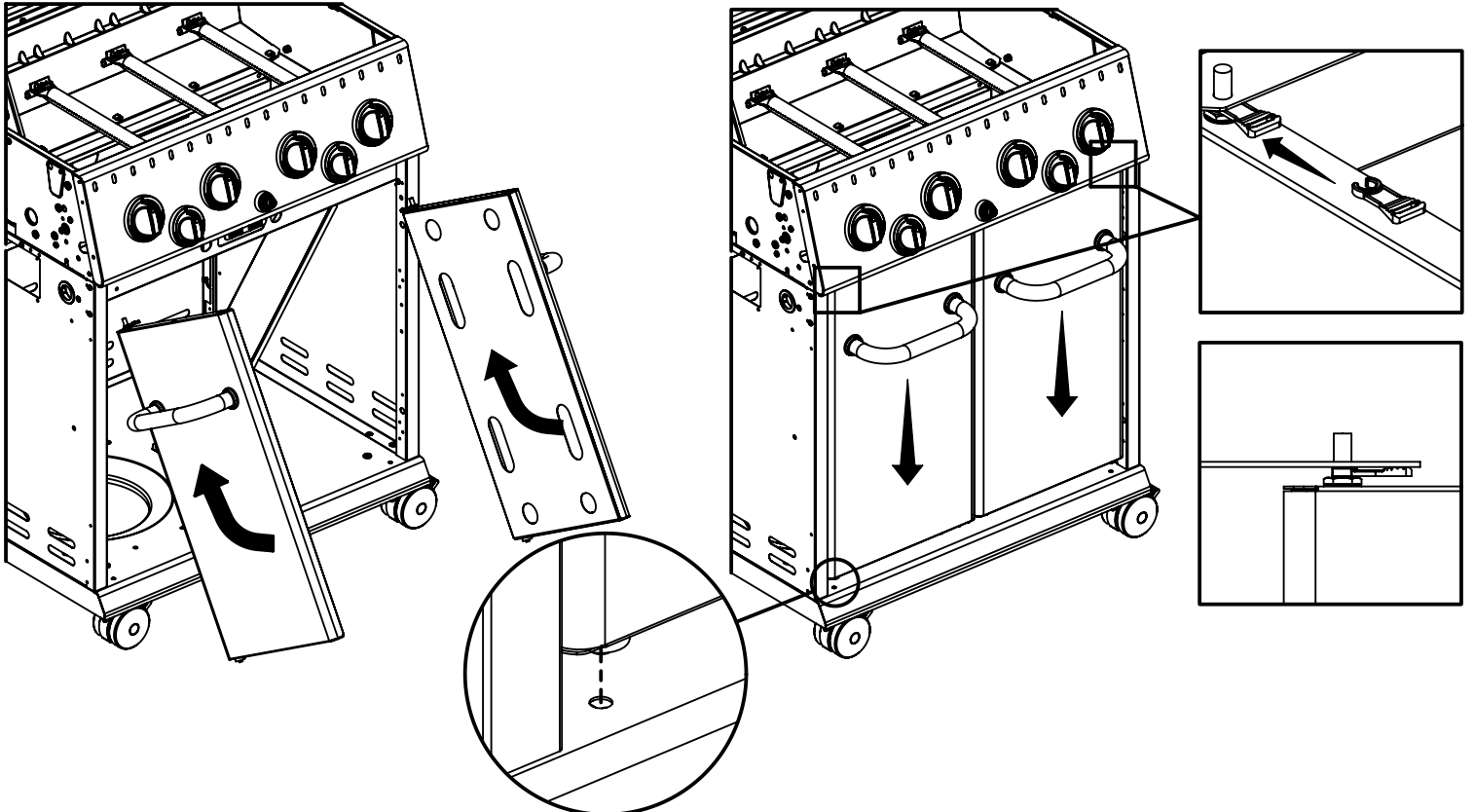
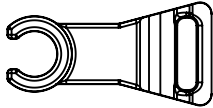

13

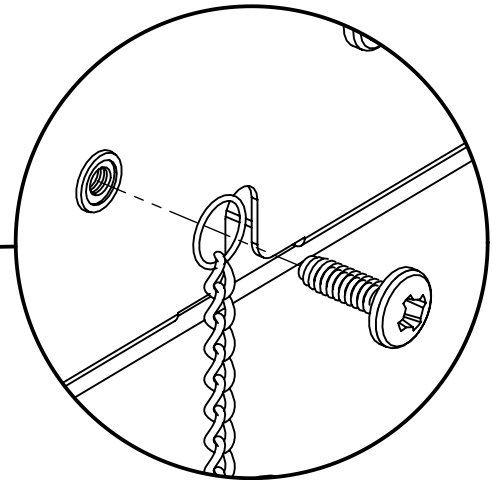
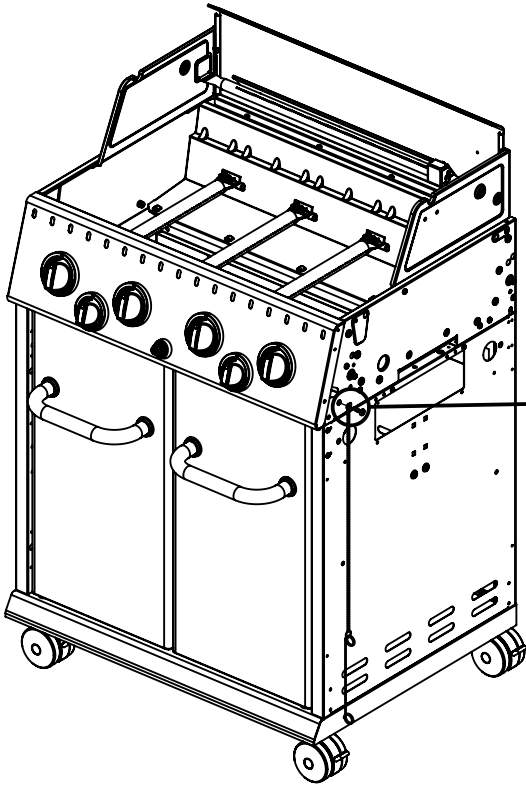
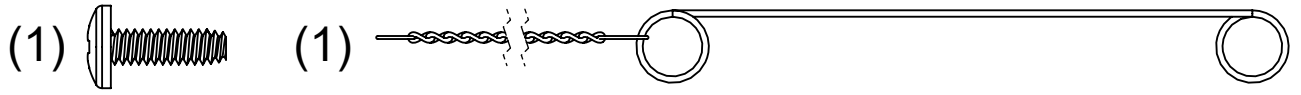

14

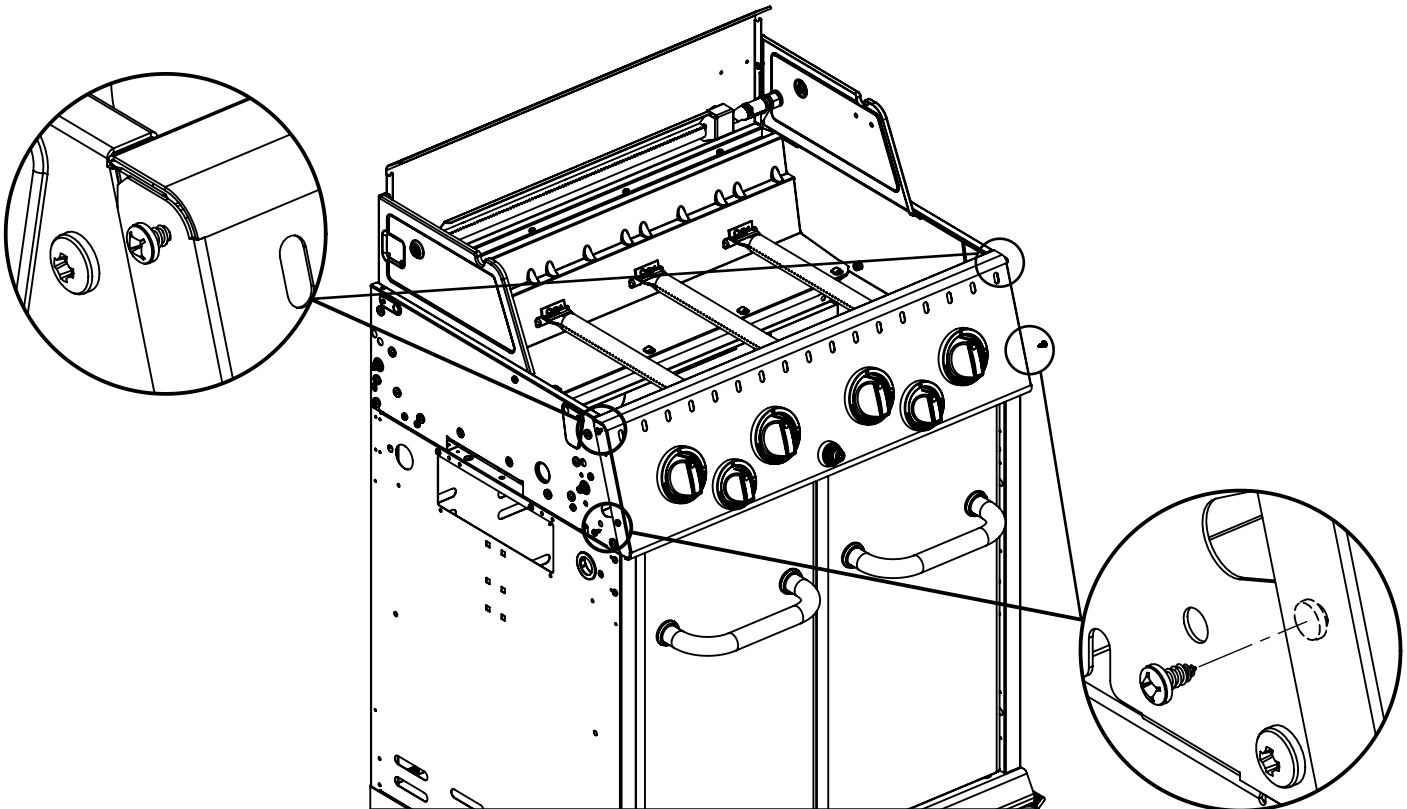

15

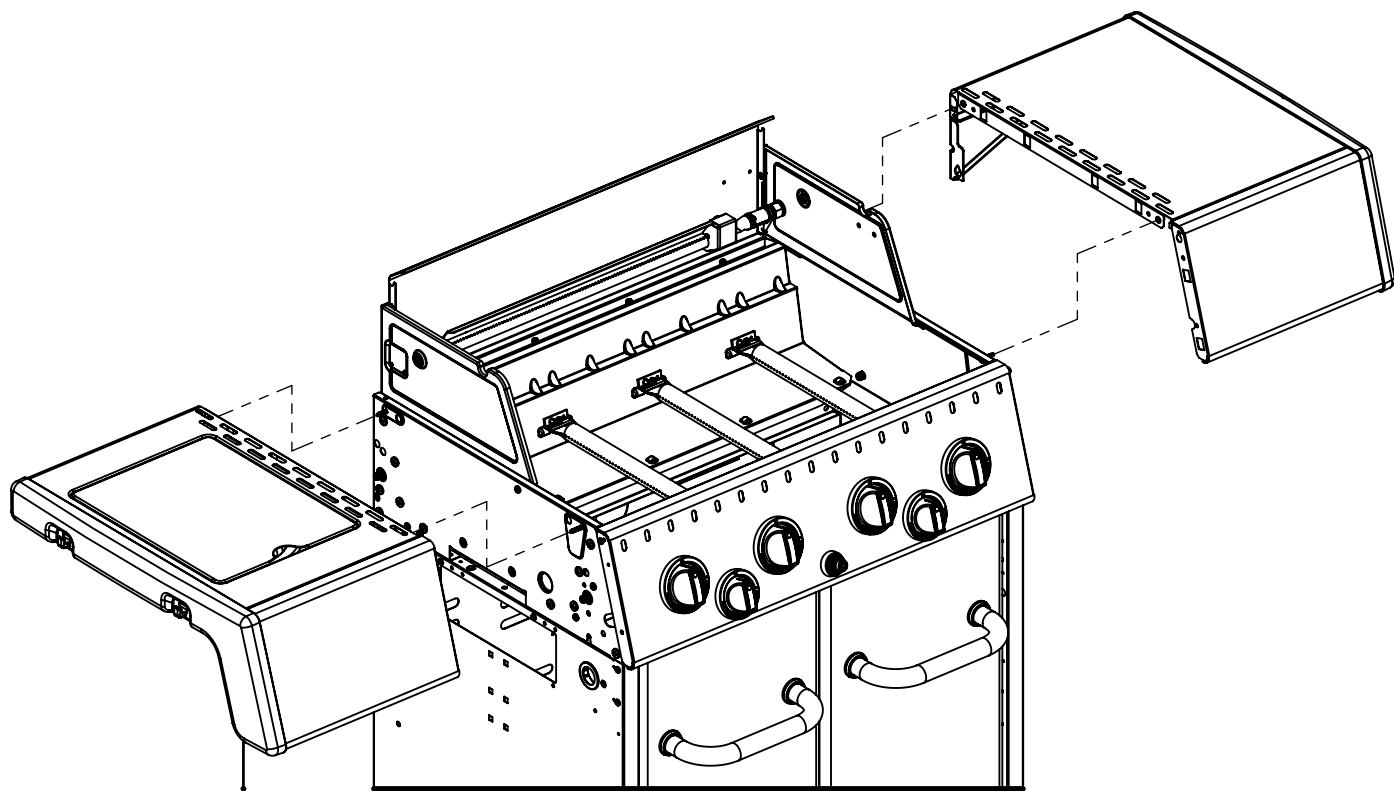

16

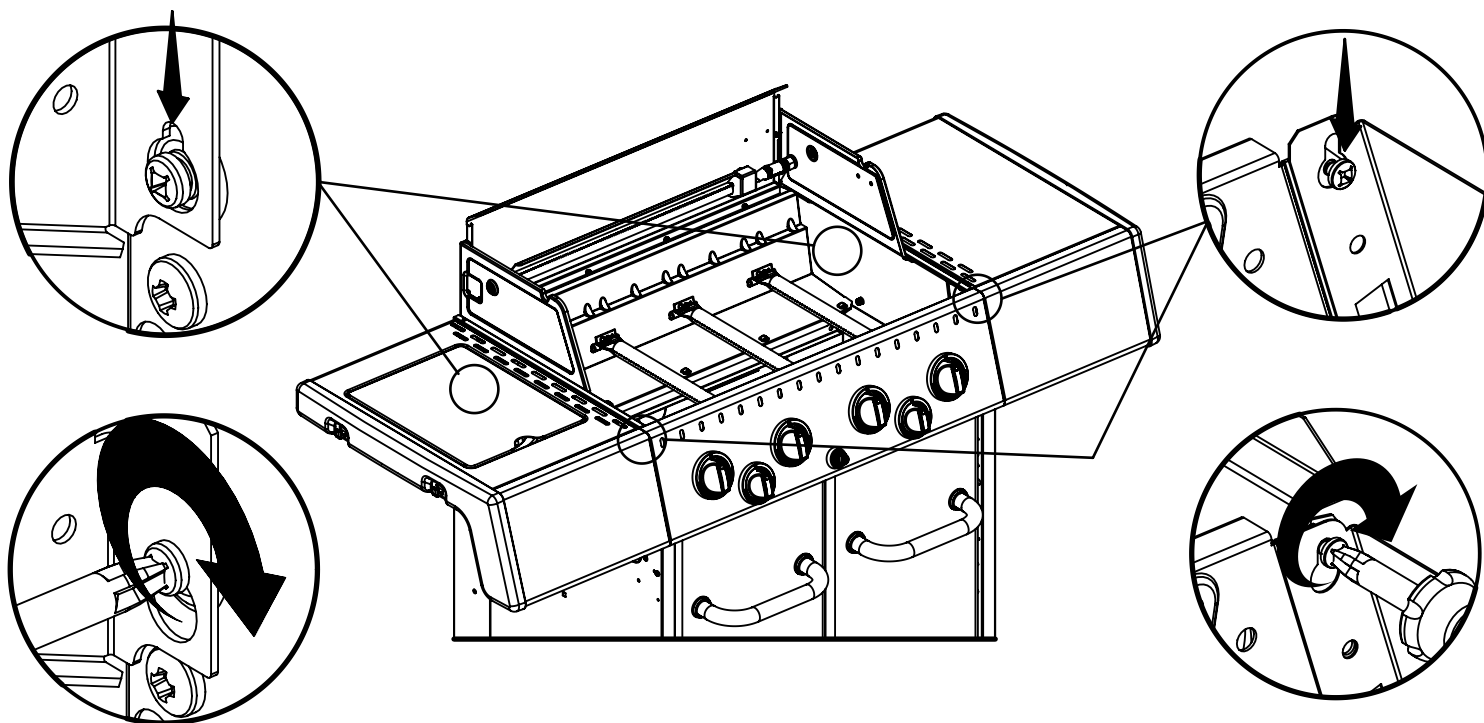

17

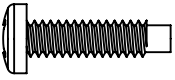
(4) 

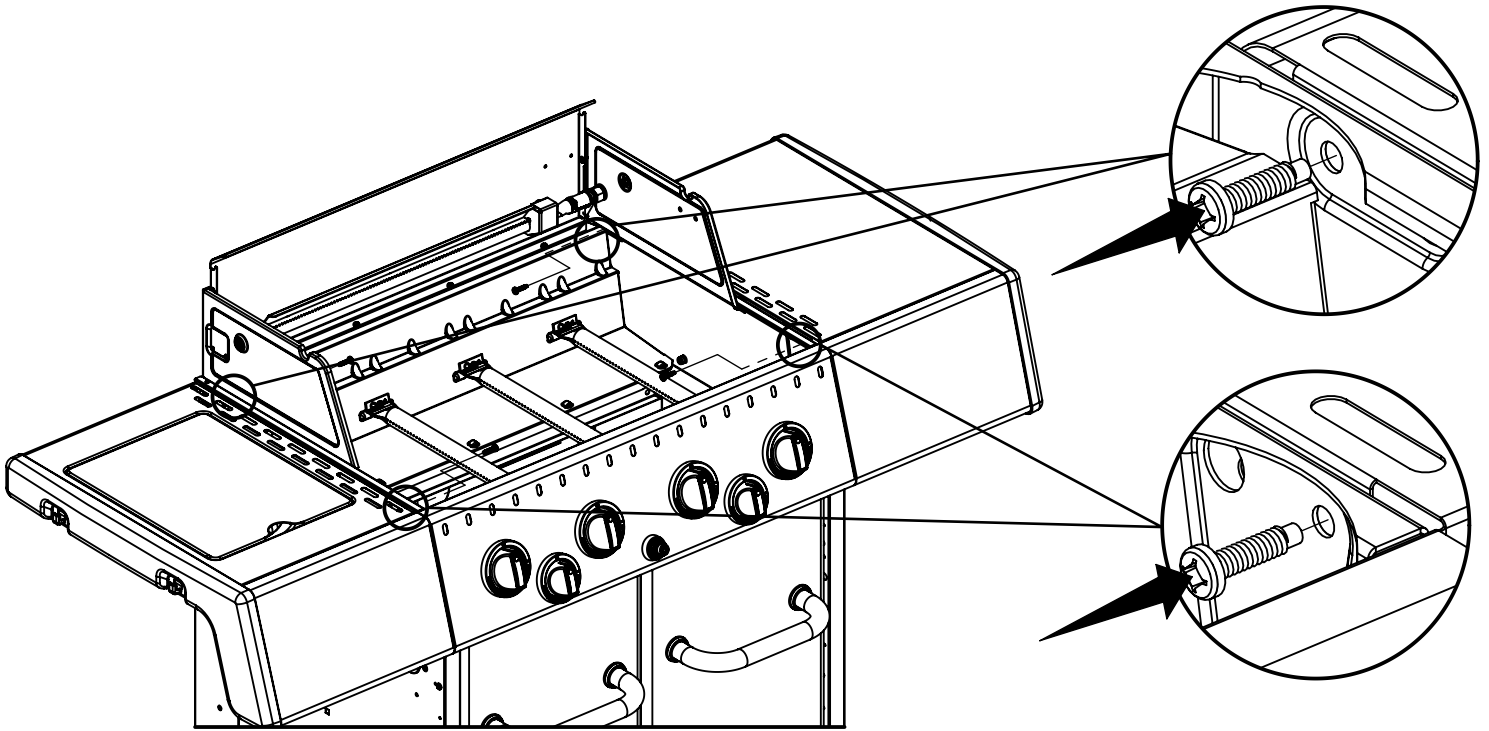

18

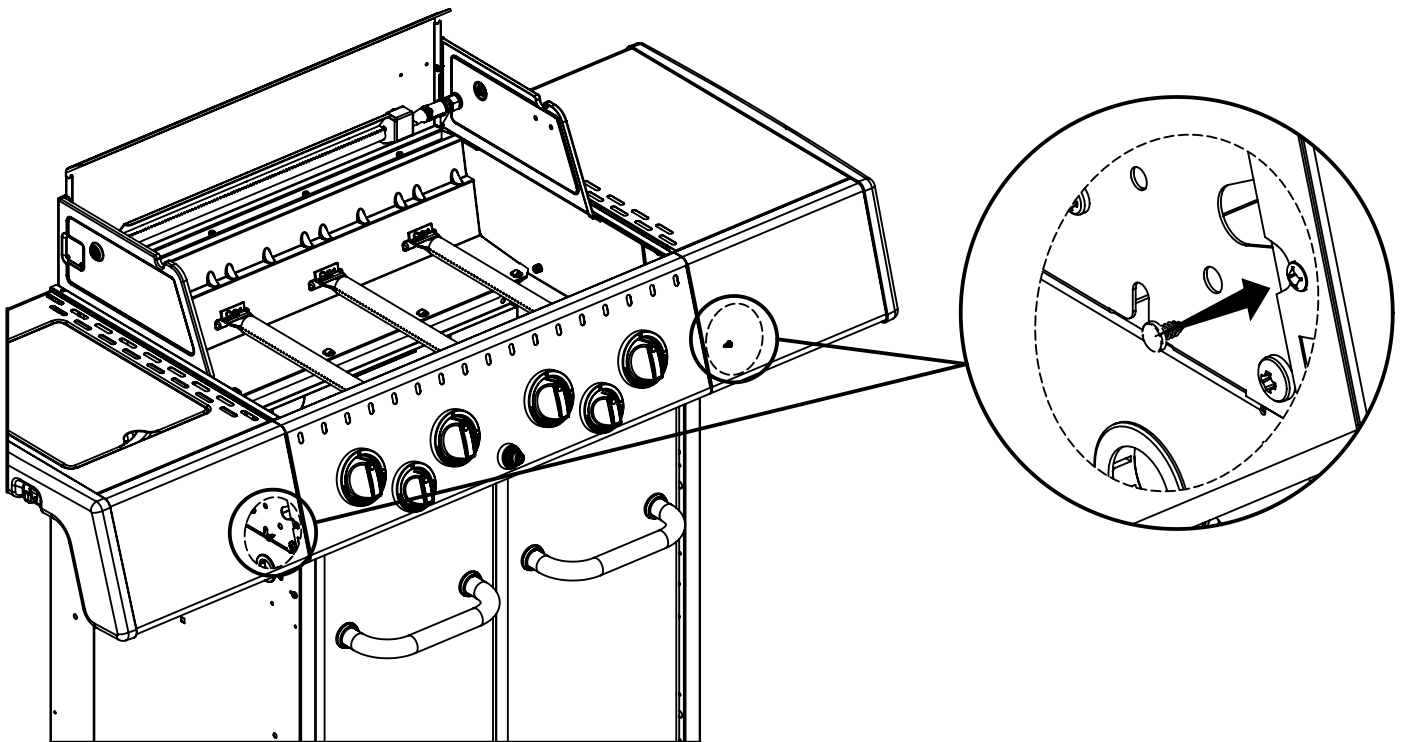

19

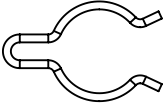
(1) 

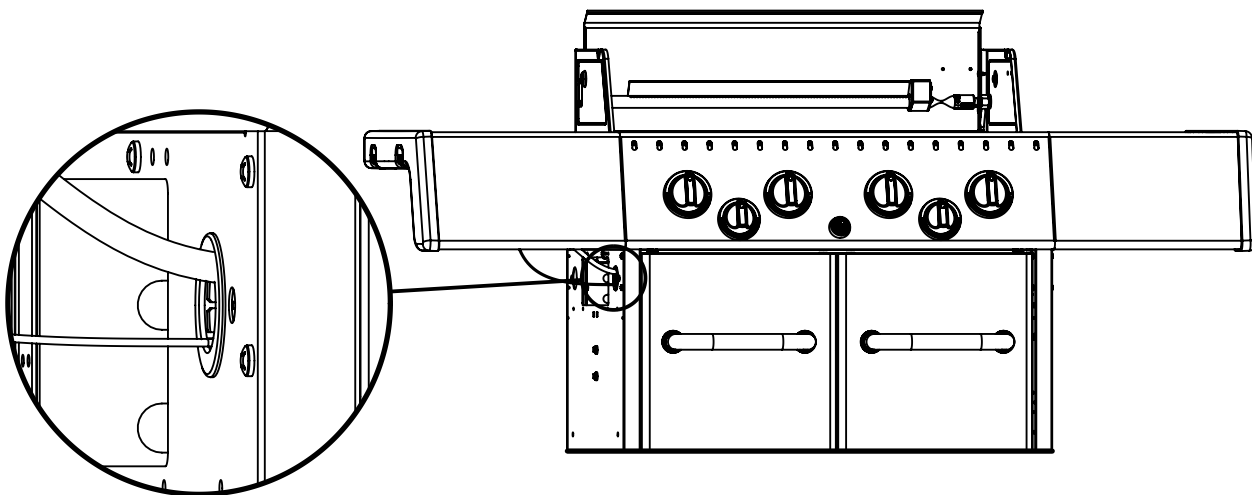
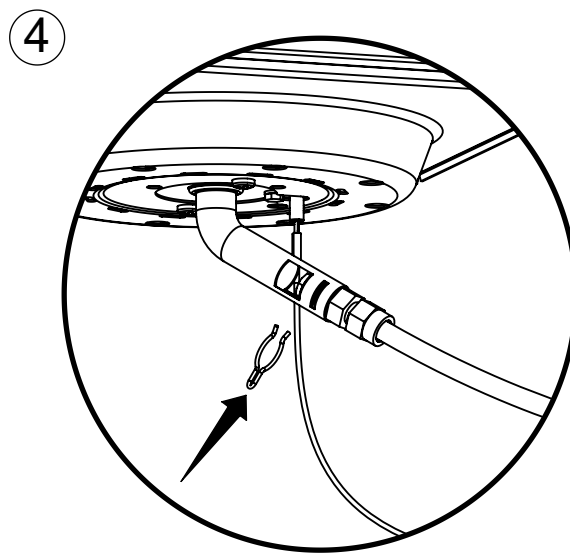
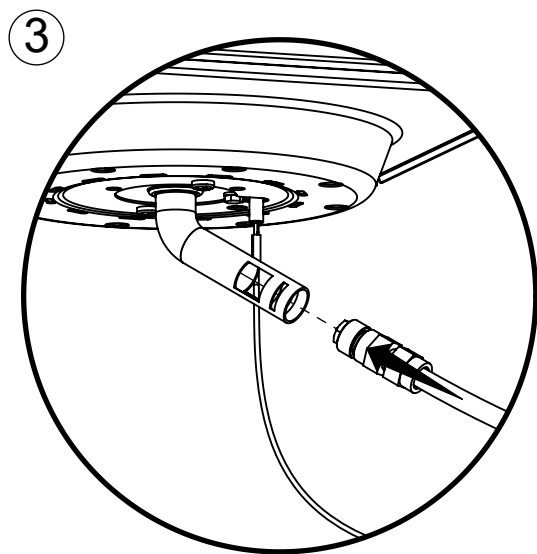
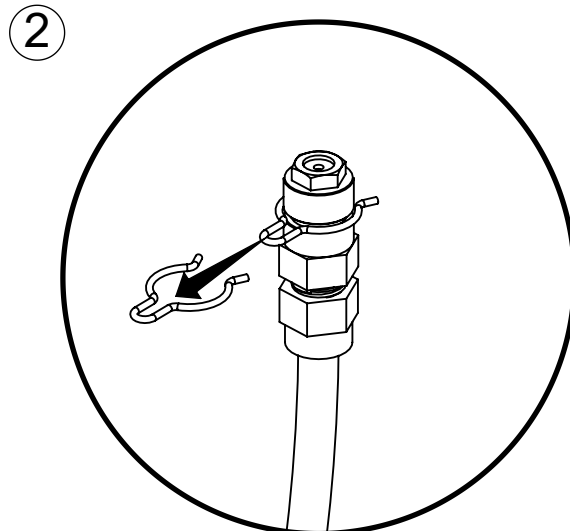
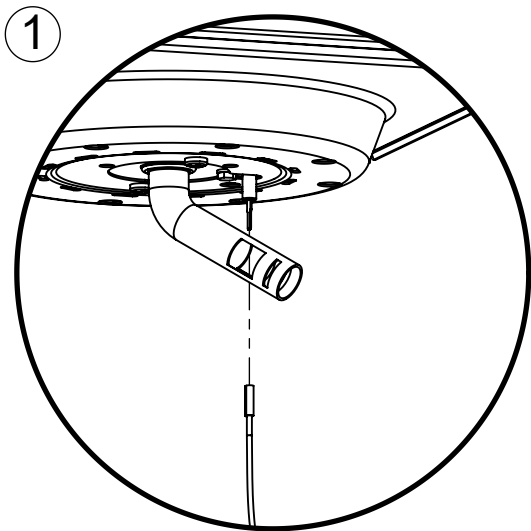

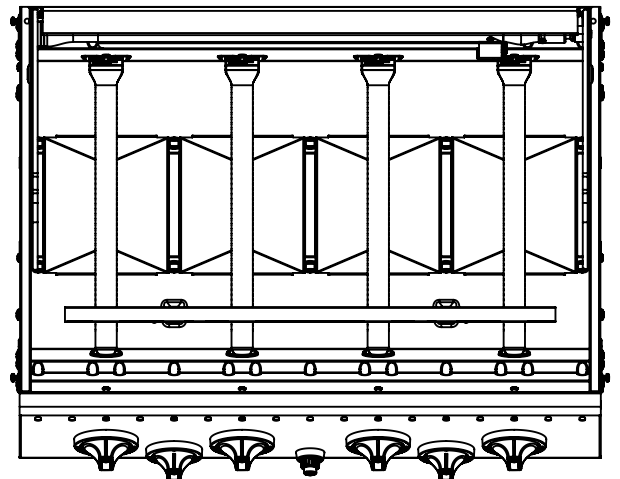
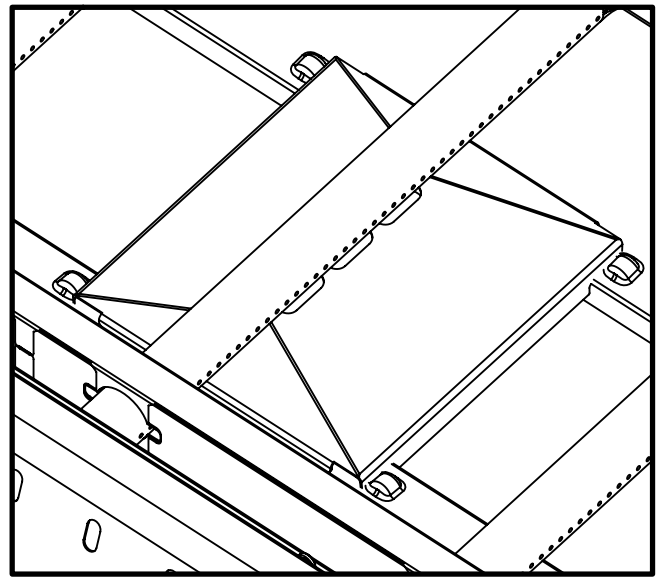
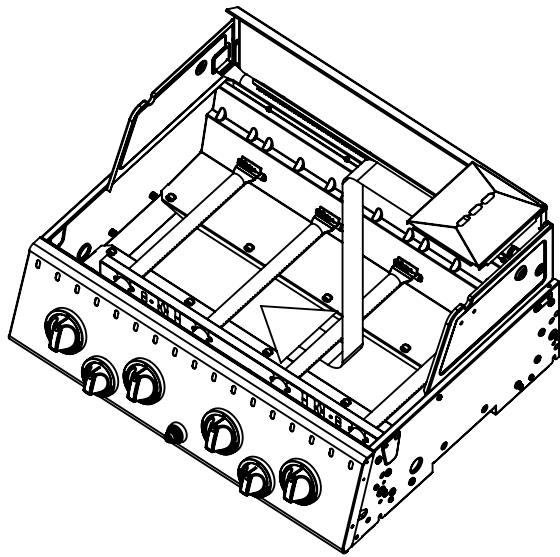
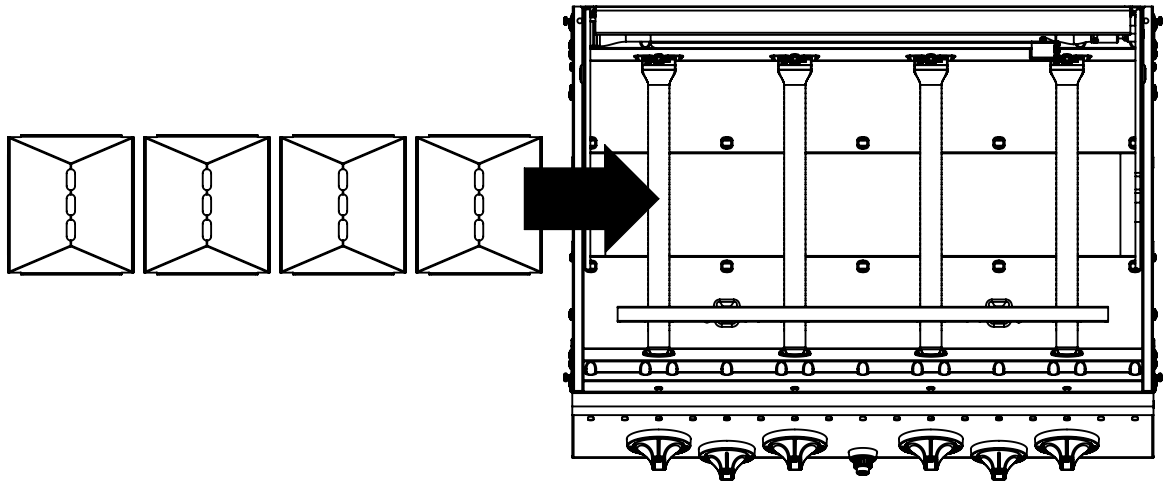

21

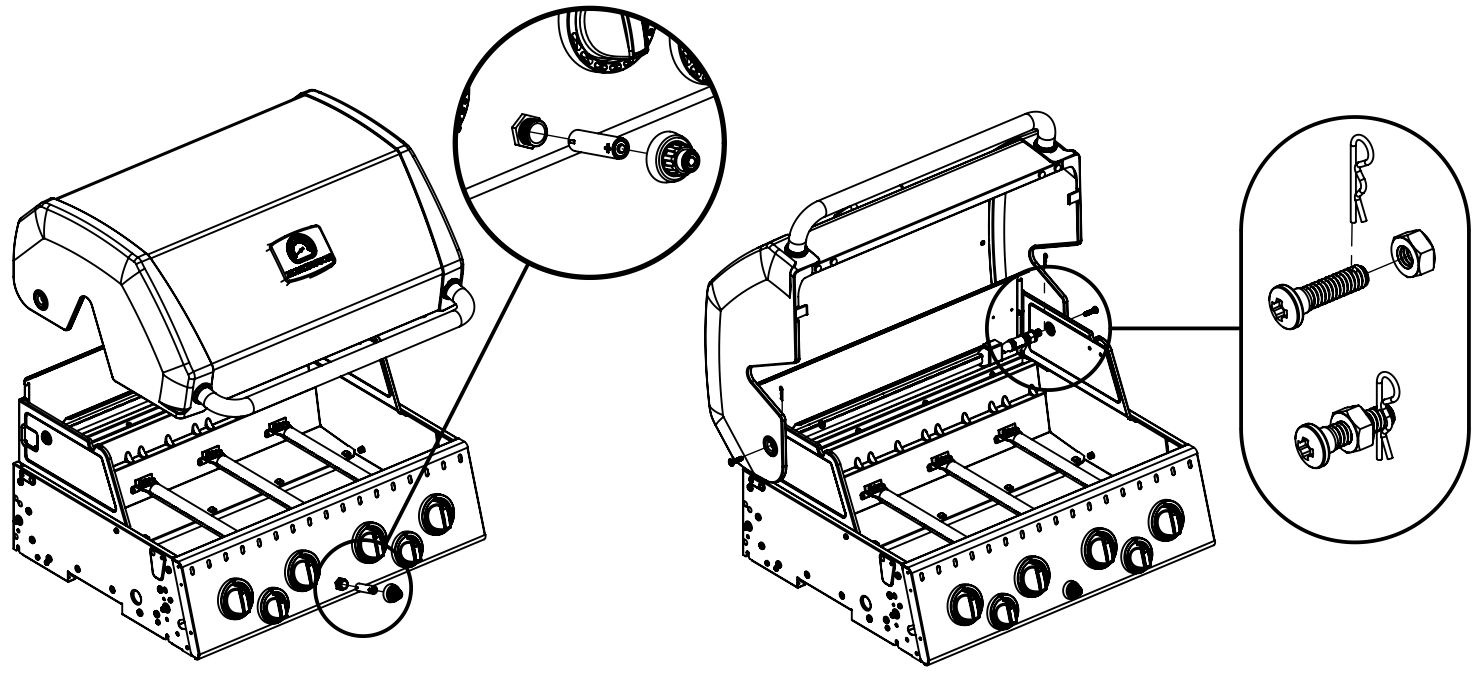
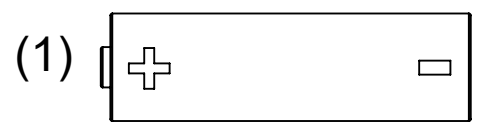
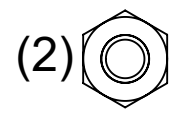
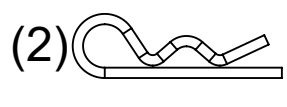
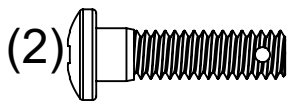

22

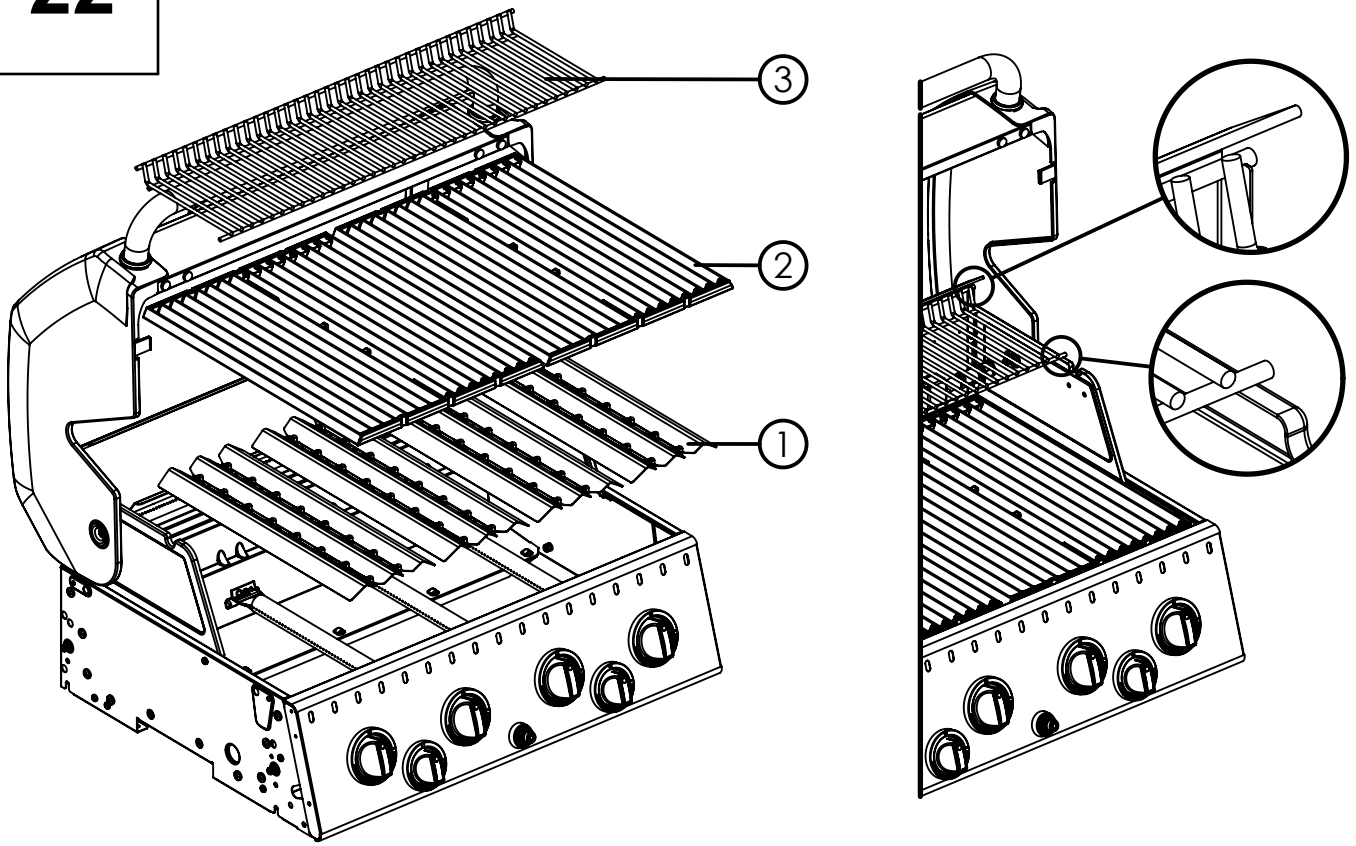

23

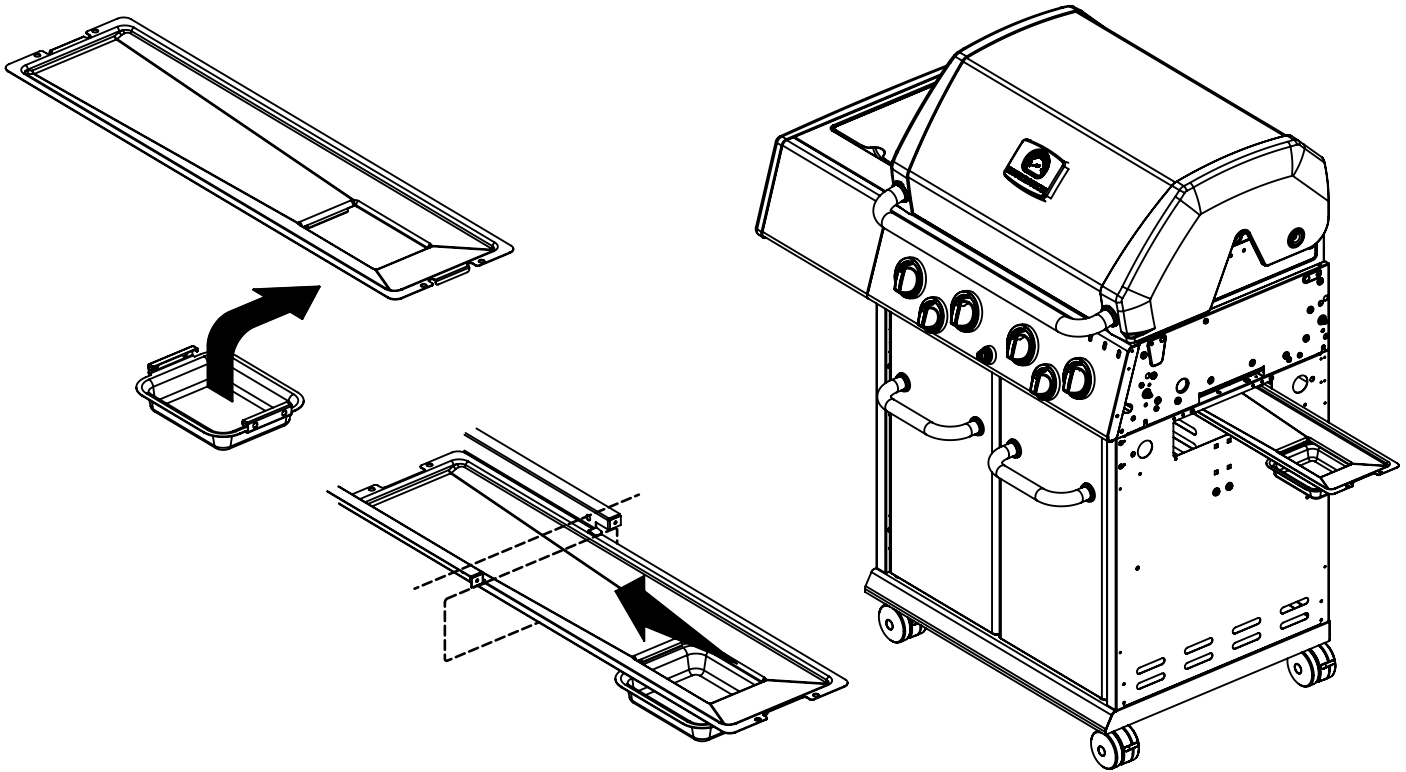

24

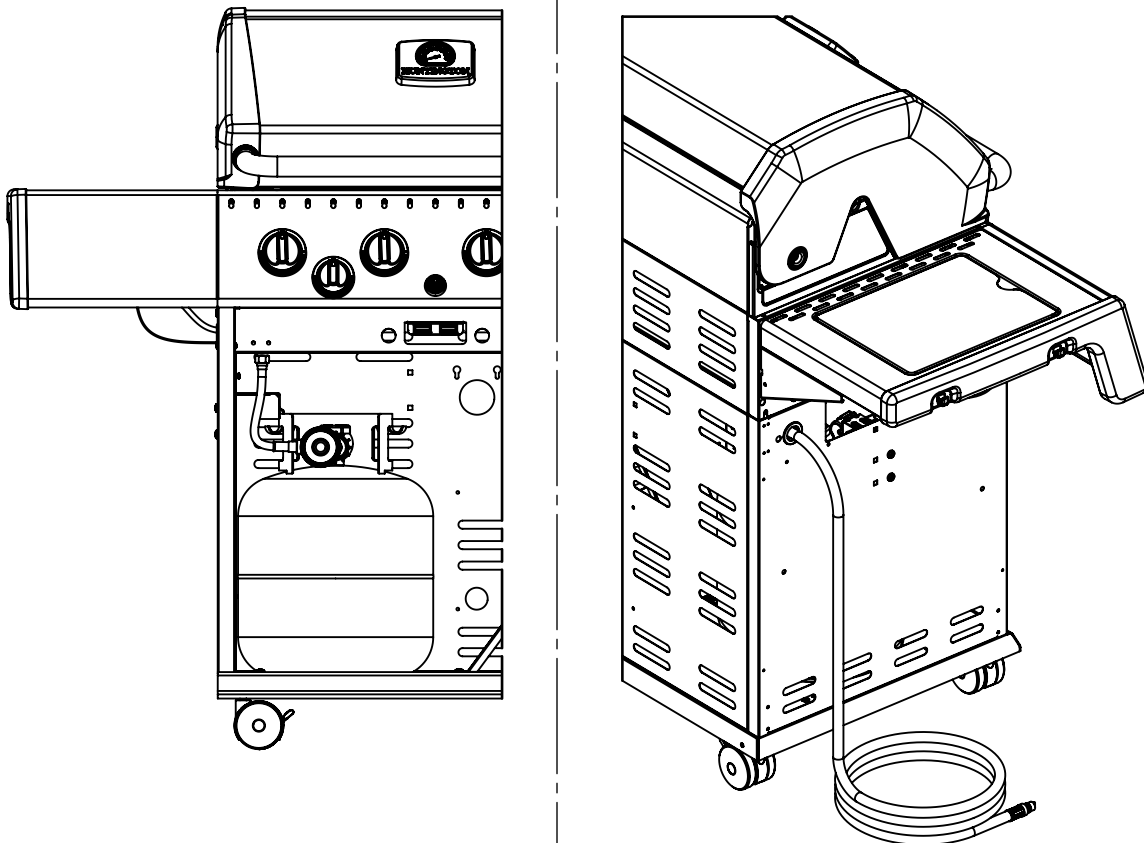

25

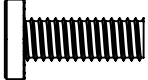
(2)  (2) 